

# Nikon

with **WARRANTY**

DIGITAL CAMERA

# D6

## User's Manual (with Warranty)

- Read this manual thoroughly before using the camera.
- To ensure proper use of the camera, be sure to read "For Your Safety" (page xviii).
- After reading this manual, keep it in a readily accessible place for future reference.



Scan for detailed operating instructions.

nikon download center D6



En

# Package Contents

Be sure all items listed here were included with your camera.

- Camera



- BF-1B body cap



- BS-3 accessory shoe cover  
( 204)



- EN-EL18c rechargeable Li-ion battery with terminal cover

- MH-26a battery charger with power cable and two contact protectors (shape of power cable depends on country or region of sale)

- HDMI/USB cable clip  
( 206)

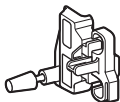

- UC-E24 USB cable

- AN-DC22 strap

- Warranty* (printed on the back cover of this manual)

- User's Manual*

Memory cards are sold separately.

**D6 Model Name: N1823**

---

## **✔ The Nikon Download Center**

A pdf version of this manual is available from the Nikon Download Center, together with an English-language reference manual with detailed operating instructions, which can be downloaded in pdf format or viewed online in html. Visit the Nikon Download Center to download firmware updates, NX Studio and other Nikon computer software, and manuals for other Nikon products including cameras, NIKKOR lenses, and flash units.





<https://downloadcenter.nikonimglib.com/>

---

# About This Manual

## ■ Symbols

The following symbols and conventions are employed in this manual. Use them to help locate the information you need.

	This icon marks notes, information that should be read before using this product.
	This icon marks tips, additional information you may find helpful when using this product.
	This icon marks references to other sections in this manual.

## ■ Conventions

- This camera uses CFexpress (Type B) and XQD memory cards. Throughout this manual, CFexpress and XQD memory cards are generally referred to as “memory cards”. The terms “CFexpress cards” and “XQD cards” are however used where necessary to distinguish between the two types.
- Throughout this manual, battery chargers are referred to as “battery chargers” or “chargers”.
- Throughout this manual, smartphones and tablets are referred to as “smart devices”.
- Throughout this manual, the term “default settings” is used to refer to the settings in effect at shipment. The explanations in this manual assume that default settings are used.

---

### **For Your Safety**

“For Your Safety” contains important safety instructions. Be sure to read them before using the camera. For more information, see “For Your Safety” (📖 xviii).

---

### **■ Nikon User Support**

Visit the site below to register your camera and keep up-to-date with the latest product information. You will find answers to frequently asked questions (FAQs) and can contact us for technical assistance.



<https://www.europe-nikon.com/support>

# Table of Contents

Package Contents .....	ii
About This Manual.....	iv
Menu List.....	xii
For Your Safety .....	xviii
Notices .....	xxvi
<b>Getting to Know the Camera</b> .....	<b>1</b>
<hr/>	
Parts of the Camera .....	1
Camera Body.....	1
The Power Switch.....	8
The Top Control Panel .....	9
The Rear Control Panel.....	11
The Viewfinder .....	12
The Live View Displays (Photos/Movies).....	15
Touch Controls .....	18
<b>First Steps</b> .....	<b>27</b>
<hr/>	
Readying the Camera .....	27
Attaching the Strap .....	27
Charging the Battery.....	28

Inserting the Battery .....	32
Attaching a Lens.....	35
Inserting Memory Cards.....	38
Camera Setup.....	43
The Battery Level and Number of Exposures Remaining.....	47
Battery Level .....	47
Memory Card Indicators and Number of Exposures Remaining .....	48
<b>Basic Photography and Playback</b>	<b>50</b>
<hr/>	
Taking Photographs .....	50
Framing Photographs in the Viewfinder (Viewfinder Photography).....	50
Framing Photographs in the Monitor (Live View).....	55
Recording Movies.....	63
Taking Photos During Filming .....	70
Playback.....	71
Viewing Movies .....	73
Deleting Unwanted Pictures.....	76
Uploading Pictures.....	77
Uploading Pictures to Smart Devices.....	77
Uploading Pictures to a Computer or FTP Server .....	77

---

The <b>MENU</b> Button .....	80
Using the Menus.....	81
The <b>i</b> Button (the <b>i</b> Menu) .....	88
The Still Photography <b>i</b> Menu.....	90
The Movie <b>i</b> Menu .....	92
The Playback <b>i</b> Menu.....	93
The <b>info</b> Button .....	94
Viewfinder Photography .....	94
Live View Photography .....	95
The Focus-Mode Selector.....	97
The AF-Mode Button.....	98
Choosing an AF Mode .....	98
Choosing an AF-Area Mode.....	101
The AF-ON Button.....	107
The <b>MODE</b> Button.....	108
Choosing an Exposure Mode .....	108
The Release Mode Dial and  Button .....	109
Choosing a Release Mode .....	109
The  Button .....	111
Choosing a Metering Option .....	111
The BKT Button .....	113



The <b>ISO</b> (FORMAT) Button .....	114
Adjusting ISO Sensitivity .....	114
Enabling Auto ISO Sensitivity Control .....	116
The <b>AE-L/AF-ON</b> Button .....	117
Adjusting Exposure Compensation .....	117
The <b>QUAL</b> Button .....	118
Adjusting Image Quality .....	118
Choosing an Image Size .....	120
The <b>WB</b> Button .....	121
Adjusting White Balance .....	121
The <b>Picture Control</b> (P/?) Button .....	125
Choosing a Picture Control .....	125
The <b>Flash</b> (Flash) Button .....	131
Choosing a Flash Mode .....	131
Adjusting Flash Compensation .....	133
The <b>Pv</b> Button .....	134
The <b>Fn1, Fn2, Fn3</b> (Fn), and <b>Fn</b> (Vertical) Buttons .....	135
<b>Troubleshooting</b> .....	<b>136</b>
<hr/>	
Before Contacting Customer Support .....	136
Problems and Solutions .....	138
Battery/Display .....	138
Shooting .....	140

Playback.....	147
Bluetooth and Wi-Fi (Wireless Networks) .....	149
Miscellaneous .....	149
Alerts and Error Messages.....	150
Alerts.....	150
Error Messages .....	155
<b>Technical Notes</b>	<b>159</b>
<hr/>	
Camera Displays .....	159
The Viewfinder .....	159
The Information Display .....	164
Live View (Still Photography/Movies) .....	167
The Top Control Panel .....	171
The Rear Control Panel.....	174
Compatible F Mount Lenses .....	175
CPU lenses.....	175
Non-CPU lenses and Other Accessories.....	183
The Electronic Rangefinder .....	187
Compatible Flash Units.....	189
The Nikon Creative Lighting System (CLS).....	189
Other Compatible Accessories.....	198
Attaching a Power Connector and AC Adapter .....	207

Software .....	209
Caring for the Camera .....	211
Storage .....	211
Cleaning .....	211
The Low-Pass Filter.....	213
Replacing the Clock Battery.....	221
Caring for the Camera and Battery: Cautions.....	223
Camera Care .....	223
Battery Care.....	227
Using the Charger.....	230
Exposure Program .....	231
Specifications .....	232
Nikon D6 Digital Camera.....	232
Calibrating Batteries .....	252
Approved Memory Cards.....	257
Memory Card Capacity .....	258
[FX (36 × 24)] Selected for Image Area.....	258
[DX (24 × 16)] Selected for Image Area.....	260
Battery Endurance.....	263
Location Data (GPS/GLONASS).....	266
Trademarks and Licenses.....	267
Notices .....	271
Bluetooth and Wi-Fi (Wireless LAN) .....	273
Index.....	278
Warranty Terms - Nikon Europe Service Warranty .....	283

# Menu List

The camera offers the following menus. Some items may not be displayed depending on camera settings or on the type of lens, flash unit, or other accessory attached.

<b>PLAYBACK MENU</b>	<b>PHOTO SHOOTING MENU</b>
Delete	Photo shooting menu bank
Playback folder	Extended photo menu banks
Playback display options	Storage folder
Delete images from both slots	File naming
Dual-format recording PB slot	Role played by card in Slot 2
Filtered playback criteria	Image area
Image review	Image quality
After delete	Image size
After burst, show	NEF (RAW) recording
Rotate tall	ISO sensitivity settings
Copy image(s)	White balance
Hide image	Set Picture Control
Slide show	Manage Picture Control
	Color space
	Active D-Lighting
	Long exposure NR
	High ISO NR

**PHOTO SHOOTING MENU**

Vignette control  
Diffraction compensation  
Auto distortion control  
Flicker reduction  
Flash control  
Auto bracketing  
Multiple exposure  
HDR (high dynamic range)  
Interval timer shooting  
Time-lapse movie  
Focus shift shooting  
Silent live view photography

**MOVIE SHOOTING MENU**

Reset movie shooting menu  
File naming  
Destination  
Image area  
Frame size/frame rate  
Movie quality  
Movie file type  
ISO sensitivity settings  
White balance  
Set Picture Control  
Manage Picture Control  
Active D-Lighting  
High ISO NR  
Diffraction compensation  
Flicker reduction  
Electronic VR  
Microphone sensitivity  
Attenuator  
Frequency response  
Wind noise reduction  
Headphone volume  
Timecode

**CUSTOM SETTING MENU**

## Custom settings bank

## a Autofocus

a1	AF-C priority selection
a2	AF-S priority selection
a3	Focus tracking with lock-on
a4	Focus points used
a5	Store points by orientation
a6	AF activation
a7	Single-point AF watch area
a8	3D-tracking face-detection
a9	Group-area AF face detection
a10	Custom groupings (C1/C2)
a11	Auto-area AF face detection
a12	Auto-area AF starting point
a13	Focus point persistence
a14	Limit AF-area mode selection
a15	Autofocus mode restrictions
a16	Focus point wrap-around
a17	Focus point options
a18	Manual focus ring in AF mode

**CUSTOM SETTING MENU**

## b Metering/exposure

b1	ISO sensitivity step value
b2	EV steps for exposure cntrl
b3	Exp./flash comp. step value
b4	Easy exposure compensation
b5	Matrix metering
b6	Center-weighted area
b7	Fine-tune optimal exposure
b8	Keep exp. when f/ changes

## c Timers/AE lock

c1	Shutter-release button AE-L
c2	Standby timer
c3	Self-timer
c4	Monitor off delay

**CUSTOM SETTING MENU****d Shooting/display**

d1	Continuous shooting speed
d2	Max. continuous release
d3	Limit release mode selection
d4	Sync. release mode options
d5	Exposure delay mode
d6	Electronic front-curtain shutter
d7	Extended shutter speeds (M)
d8	Limit selectable image area
d9	File number sequence
d10	Peaking highlights
d11	Framing grid display
d12	Rear control panel
d13	LCD illumination
d14	Live view in continuous mode
d15	Optical VR

**CUSTOM SETTING MENU****e Bracketing/flash**

e1	Flash sync speed
e2	Flash shutter speed
e3	Exposure comp. for flash
e4	Auto  ISO sensitivity control
e5	Flash burst priority
e6	Modeling flash
e7	Auto bracketing (mode M)
e8	Bracketing order
e9	Bracketing burst options

**CUSTOM SETTING MENU**

## f Controls

f1	Customize <b>f</b> menu
f2	Customize <b>f</b> menu (Lv)
f3	Custom controls
f4	Multi selector center button
f5	Shutter spd & aperture lock
f6	Customize command dials
f7	Multi selector
f8	Release button to use dial
f9	Reverse indicators
f10	Live view button options
f11	<b>⌘</b> switch
f12	Full-frame playback flicks
f13	Prefer sub-selector center

## g Movie

g1	Customize <b>f</b> menu
g2	Custom controls
g3	Multi selector center button
g4	Highlight display

**SETUP MENU**

Format memory card
Language
Time zone and date
Monitor brightness
Monitor color balance
Virtual horizon
Information display
AF fine-tuning options
Non-CPU lens data
Clean image sensor
Lock mirror up for cleaning
Image Dust Off ref photo
Pixel mapping
Image comment
Copyright information
IPTC
Voice memo options
Beep options
Touch controls
HDMI
Location data (built-in)



**SETUP MENU**

Wireless remote (WR) options  
Assign remote (WR) Fn button  
Airplane mode  
Connect to smart device  
Connect to PC (built-in Wi-Fi)  
Wired LAN/WT  
Conformity marking  
Battery info  
Slot empty release lock  
Save/load menu settings  
Reset all settings  
Firmware version

**RETOUCH MENU**

NEF (RAW) processing  
Trim  
Resize  
D-Lighting  
Red-eye correction  
Straighten  
Distortion control  
Perspective control  
Monochrome  
Image overlay  
Trim movie

**MY MENU**

Add items  
Remove items  
Rank items  
Choose tab

## For Your Safety

To prevent damage to property or injury to yourself or to others, read “For Your Safety” in its entirety before using this product.

Keep these safety instructions where all those who use this product will read them.

**⚠ DANGER:** Failure to observe the precautions marked with this icon carries a high risk of death or severe injury.

**⚠ WARNING:** Failure to observe the precautions marked with this icon could result in death or severe injury.

**⚠ CAUTION:** Failure to observe the precautions marked with this icon could result in injury or property damage.

### **⚠ WARNING**

**Do not use while walking or operating a vehicle.**

Failure to observe this precaution could result in accidents or other injury.

**Do not disassemble or modify this product. Do not touch internal parts that become exposed as the result of a fall or other accident.**

Failure to observe these precautions could result in electric shock or other injury.

**Should you notice any abnormalities such as the product producing smoke, heat, or unusual odors, immediately disconnect the battery or power source.**

Continued operation could result in fire, burns or other injury.

**Keep dry. Do not handle with wet hands. Do not handle the plug with wet hands.**

Failure to observe these precautions could result in fire or electric shock.

---

**Do not let your skin remain in prolonged contact with this product while it is on or plugged in.**

Failure to observe this precaution could result in low-temperature burns.

---

**Do not use this product in the presence of flammable dust or gas such as propane, gasoline or aerosols.**

Failure to observe this precaution could result in explosion or fire.

---

**Do not directly view the sun or other bright light source through the lens or camera.**

Failure to observe this precaution could result in visual impairment.

---

**Do not aim the flash or AF-assist illuminator at the operator of a motor vehicle.**

Failure to observe this precaution could result in accidents.

---

**Keep this product out of reach of children.**

Failure to observe this precaution could result in injury or product malfunction. In addition, note that small parts constitute a choking hazard. Should a child swallow any part of this product, seek immediate medical attention.

---

**Do not entangle, wrap or twist the straps around your neck.**

Failure to observe this precaution could result in accidents.

---

**Do not use batteries, chargers, or AC adapters not specifically designated for use with this product. When using batteries, chargers, and AC adapters designated for use with this product, do not:**

- **Damage, modify, forcibly tug or bend the cords or cables, place them under heavy objects, or expose them to heat or flame.**
- **Use travel converters or adapters designed to convert from one voltage to another or with DC-to-AC inverters.**

Failure to observe these precautions could result in fire or electric shock.

---

**Do not handle the plug when charging the product or using the AC adapter during thunderstorms.**

Failure to observe this precaution could result in electric shock.

---

**Do not handle with bare hands in locations exposed to extremely high or low temperatures.**

Failure to observe this precaution could result in burns, or frostbite.

---

 **CAUTION**

**Do not leave the lens pointed at the sun or other strong light sources.**

Light focused by the lens could cause fire or damage to product's internal parts. When shooting backlit subjects, keep the sun well out of the frame. Sunlight focused into the camera when the sun is close to the frame could cause fire.

---

**Turn this product off when its use is prohibited. Disable the location data feature. End location tracking. Disable wireless features when the use of wireless equipment is prohibited.**

The radio-frequency emissions produced by this product could interfere with equipment onboard aircraft or in hospitals or other medical facilities.

---

**Remove the battery and disconnect the AC adapter if this product will not be used for an extended period.**

Failure to observe this precaution could result in fire or product malfunction.

---

**Do not fire the flash in contact with or in close proximity to the skin or objects.**

Failure to observe this precaution could result in burns or fire.

---

**Do not leave the product where it will be exposed to extremely high temperatures, for an extended period such as in an enclosed automobile or in direct sunlight.**

Failure to observe this precaution could result in fire or product malfunction.

---

**Do not look directly at the AF-assist illuminator.**

Failure to observe this precaution could have adverse effects on vision.

---

**Do not transport cameras or lenses with tripods or similar accessories attached.**

Failure to observe this precaution could result in injury or product malfunction.

---

## **DANGER (Batteries)**

### **Do not mishandle batteries.**

Failure to observe the following precautions could result in the batteries leaking, overheating, rupturing, or catching fire:

- Use only rechargeable batteries approved for use in this product.
- Do not expose batteries to flame or excessive heat.
- Do not disassemble.
- Do not short-circuit the terminals by touching them to necklaces, hairpins, or other metal objects.
- Do not expose batteries or the products in which they are inserted to powerful physical shocks.
- Do not step on batteries, pierce them with nails, or strike them with hammers.

---

### **Charge only as indicated.**

Failure to observe this precaution could result in the batteries leaking, overheating, rupturing, or catching fire.

---

### **If battery liquid comes into contact with the eyes, rinse with plenty of clean water and seek immediate medical attention.**

Delaying action could result in eye injuries.

---

### **Follow the instructions of airline personnel.**

Batteries left unattended at high altitudes in an unpressurized environment may leak, overheat, rupture, or catch fire.

---

## **WARNING (Batteries)**

---

### **Keep batteries out of reach of children.**

Should a child swallow a battery, seek immediate medical attention.

---

### **Keep batteries out of reach of household pets and other animals.**

The batteries could leak, overheat, rupture, or catch fire if bitten, chewed, or otherwise damaged by animals.

---

### **Do not immerse batteries in water or expose to rain.**

Failure to observe this precaution could result in fire or product malfunction. Immediately dry the product with a towel or similar object should it become wet.

---

### **Discontinue use immediately should you notice any changes in the batteries, such as discoloration or deformation. Cease charging EN-EL18c rechargeable batteries if they do not charge in the specified period of time.**

Failure to observe these precautions could result in the batteries leaking, overheating, rupturing, or catching fire.

---

### **When batteries are no longer needed, insulate the terminals with tape.**

Overheating, rupture, or fire may result should metal objects come into contact with the terminals.

---

### **If battery liquid comes into contact with a person's skin or clothing, immediately rinse the affected area with plenty of clean water.**

Failure to observe this precaution could result in skin irritation.

---

## **DANGER (CR1616 Lithium Watch Batteries)**

### **Do not mishandle batteries.**

Failure to observe the following precautions could result in the battery leaking, overheating, rupturing, or catching fire:

- Do not attempt to recharge the battery.
- Do not expose batteries to flame or excessive heat.
- Do not disassemble.
- Do not short-circuit the terminals by touching them to necklaces, hairpins, or other metal objects.
- Do not expose batteries or the products in which they are inserted to powerful physical shocks.

---

### **Do not ingest batteries.**

#### **Chemical burn hazard.**

This product includes one or more lithium coin/button cell batteries. Swallowing lithium coin/button cell batteries can cause severe internal burns in just 2 hours and can lead to death.

Keep new and used batteries away from children.

If the battery compartment does not close securely, stop using the product and keep it out of reach of children.

If you think batteries may have been swallowed or placed anywhere inside the body, seek immediate medical attention.

---

### **If battery liquid comes into contact with the eyes, rinse with plenty of clean water and seek immediate medical attention.**

Delaying action could result in eye injuries.

---

### **Follow the instructions of airline personnel.**

Batteries left unattended at high altitudes in an unpressurized environment may leak, overheat, rupture, or catch fire.

---



 **WARNING (CR1616 Lithium Watch Batteries)**

**Keep batteries out of reach of children.**

Should a child swallow a battery, seek immediate medical attention.

---

**Do not immerse batteries in water or expose to rain.**

Failure to observe this precaution could result in fire or product malfunction. Immediately dry the product with a towel or similar object should it become wet.

---

**Discontinue use immediately should you notice any changes in the battery, such as discoloration or deformation.**

Failure to observe this precaution could result in the battery leaking, overheating, rupturing, or catching fire.

---

**Insert the battery in the correct orientation.**

Failure to observe this precaution could result in the battery leaking, overheating, rupturing, or catching fire.

---

**When batteries are no longer needed, insulate the terminals with tape.**

Overheating, rupture, or fire may result should metal objects come into contact with the terminals.

---

**If battery liquid comes into contact with a person's skin or clothing, immediately rinse the affected area with plenty of clean water.**

Failure to observe this precaution could result in skin irritation.

---

## Notices

- No part of the manuals included with this product may be reproduced, transmitted, transcribed, stored in a retrieval system, or translated into any language in any form, by any means, without Nikon's prior written permission.
- Nikon reserves the right to change the appearance and specifications of the hardware and software described in these manuals at any time and without prior notice.
- Nikon will not be held liable for any damages resulting from the use of this product.
- While every effort has been made to ensure that the information in these manuals is accurate and complete, we would appreciate it were you to bring any errors or omissions to the attention of the Nikon representative in your area (address provided separately).

## ● **Notice Concerning Prohibition of Copying or Reproduction**

Note that simply being in possession of material that has been digitally copied or reproduced by means of a scanner, digital camera, or other device may be punishable by law.

### • **Items prohibited by law from being copied or reproduced**

Do not copy or reproduce paper money, coins, securities, government bonds, or local government bonds, even if such copies or reproductions are stamped "Sample."

The copying or reproduction of paper money, coins, or securities which are circulated in a foreign country is prohibited.

Unless the prior permission of the government has been obtained, the copying or reproduction of unused postage stamps or post cards issued by the government is prohibited.

The copying or reproduction of stamps issued by the government and of certified documents stipulated by law is prohibited.

### • **Cautions on certain copies and reproductions**

The government has issued cautions on copies or reproductions of securities issued by private companies (shares, bills, checks, gift certificates, etc.), commuter passes, or coupon tickets, except when a minimum of necessary copies are to be provided for business use by a company. Also, do not copy or reproduce passports issued by the government, licenses issued by public agencies and private groups, ID cards, and tickets, such as passes and meal coupons.

### • **Comply with copyright notices**

Under copyright law, photographs or recordings of copyrighted works made with the camera cannot be used without the permission of the copyright holder. Exceptions apply to personal use, but note that even personal use may be restricted in the case of photographs or recordings of exhibits or live performances.

## ● Use Only Nikon Brand Electronic Accessories

Nikon cameras are designed to the highest standards and include complex electronic circuitry. Only Nikon brand electronic accessories (including lenses, chargers, batteries, AC adapters, and flash accessories) certified by Nikon specifically for use with this Nikon digital camera are engineered and proven to operate within the operational and safety requirements of this electronic circuitry.

The use of non-Nikon electronic accessories could damage the camera and may void your Nikon warranty. The use of third-party rechargeable Li-ion batteries not bearing the Nikon holographic seal shown at right could interfere with normal operation of the camera or result in the batteries overheating, igniting, rupturing, or leaking.



For more information about Nikon brand accessories, contact a local authorized Nikon dealer.

---

## ✔ Before Taking Important Pictures

Before taking pictures on important occasions (such as at weddings or before taking the camera on a trip), take a test shot to ensure that the camera is functioning normally. Nikon will not be held liable for damages or lost profits that may result from product malfunction.

## ✔ Life-Long Learning

As part of Nikon's "Life-Long Learning" commitment to ongoing product support and education, continually-updated information is available online at the following sites:

- **For users in the U.S.A.:** <https://www.nikonusa.com/>
- **For users in Europe:** <https://www.europe-nikon.com/support/>
- **For users in Asia, Oceania, the Middle East, and Africa:**  
<https://www.nikon-asia.com/>

Visit these sites to keep up-to-date with the latest product information, tips, answers to frequently-asked questions (FAQs), and general advice on digital imaging and photography. Additional information may be available from the Nikon representative in your area. See the following URL for contact information: <https://imaging.nikon.com/>

---



# Getting to Know the Camera

## Parts of the Camera

### Camera Body

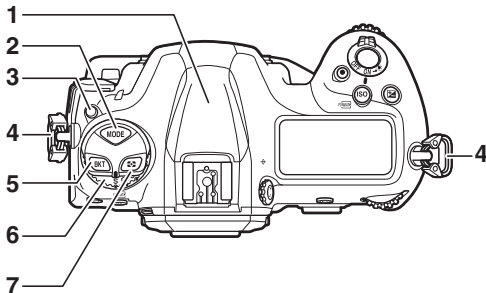

1 GNSS antenna

2 **MODE** button (☞ 108)

3 Release mode dial lock release  
(☞ 109)

4 Eyelet for camera strap (☞ 27)

5 **BKT** button (☞ 113)

6 Release mode dial (☞ 109)



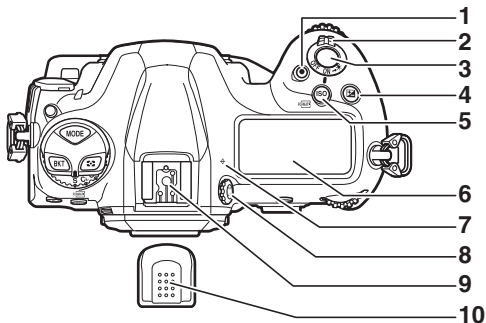



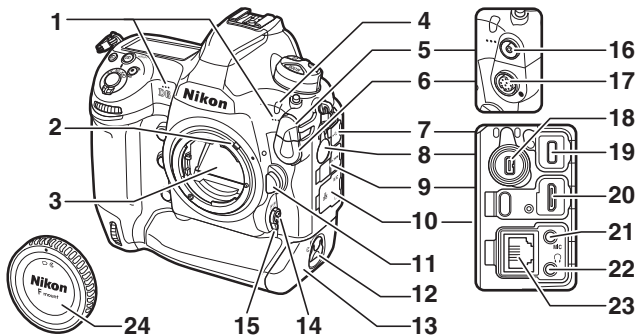

7  button (☞ 111)



- |   |  |
|---|--|
| <p><b>1</b> Movie-record button (☞ 63)</p> <p><b>2</b> Power switch (☞ 8)</p> <p><b>3</b> Shutter-release button (☞ 50)</p> <p><b>4</b>  button (☞ 117)</p> <p><b>5</b> <b>ISO</b> (FORMERLY) button (☞ 114)</p> <p><b>6</b> Top control panel (☞ 9, 171)</p> | <p><b>7</b>  (focal plane mark)</p> <p><b>8</b> Diopter adjustment control (☞ 14)</p> <p><b>9</b> Accessory shoe (for optional flash unit)</p> <p><b>10</b> Accessory shoe cover (☞ 204)</p> |
|---|--|





- |   |  |
|---|--|
| <p><b>1</b> Stereo microphone (for movies;  63)</p> <p><b>2</b> Meter coupling lever</p> <p><b>3</b> Mirror ( 63, 216)</p> <p><b>4</b> Self-timer lamp</p> <p><b>5</b> Flash sync terminal cover</p> <p><b>6</b> Ten-pin remote terminal cover</p> <p><b>7</b> USB connector cover</p> <p><b>8</b> Peripheral connector cover</p> <p><b>9</b> HDMI connector cover</p> <p><b>10</b> Cover for microphone, headphone, and Ethernet connectors</p> <p><b>11</b> Lens release button ( 37)</p> | <p><b>12</b> Battery-chamber cover latch ( 32)</p> <p><b>13</b> Battery-chamber cover ( 32)</p> <p><b>14</b> AF-mode button ( 98)</p> <p><b>15</b> Focus-mode selector ( 97)</p> <p><b>16</b> Flash sync terminal</p> <p><b>17</b> Ten-pin remote terminal</p> <p><b>18</b> Peripheral connector</p> <p><b>19</b> USB connector</p> <p><b>20</b> HDMI connector</p> <p><b>21</b> Connector for external microphone</p> <p><b>22</b> Headphone connector</p> <p><b>23</b> Ethernet connector</p> <p><b>24</b> Body cap ( 35)</p> |
|---|--|

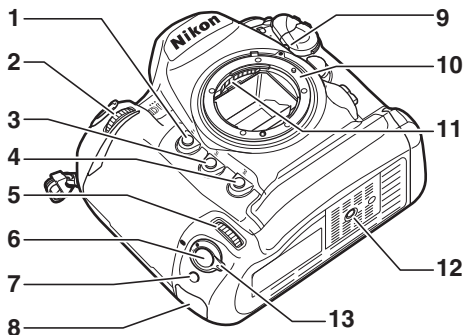

- |  |   |
|--|---|
| <p><b>1</b> Pv button (☞ 62, 134)</p> <p><b>2</b> Sub-command dial</p> <p><b>3</b> Fn1 button (☞ 135)</p> <p><b>4</b> Fn2 button (☞ 135)</p> <p><b>5</b> Sub-command dial for vertical shooting</p> <p><b>6</b> Shutter-release button for vertical shooting</p> <p><b>7</b> Fn button (vertical; ☞ 135)</p> | <p><b>8</b> Security slot (for anti-theft cable; ☞ 7)</p> <p><b>9</b> Lens mounting mark (☞ 35)</p> <p><b>10</b> Lens mount (☞ 35)</p> <p><b>11</b> CPU contacts</p> <p><b>12</b> Tripod socket</p> <p><b>13</b> Vertical shooting shutter-release button lock (☞ 54)</p> |
|--|---|

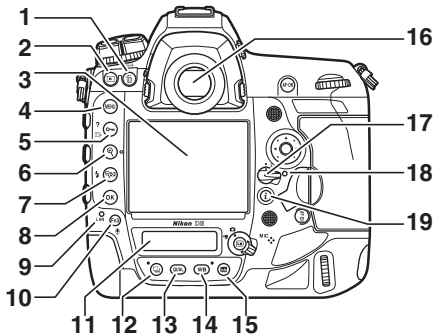

<b>1</b>	(FORMATS) button (📖 76)	<b>11</b>	Rear control panel (📖 11, 174)
<b>2</b>	button (📖 71)	<b>12</b>	button (📖 109)
<b>3</b>	Monitor (📖 18, 55, 63)	<b>13</b>	<b>QUAL</b> button (📖 118)
<b>4</b>	<b>MENU</b> button (📖 80)	<b>14</b>	<b>WB</b> button (📖 121)
<b>5</b>	(Fn) button (📖 87, 125)	<b>15</b>	<b>info</b> button (📖 94)
<b>6</b>	button (📖 61)	<b>16</b>	Viewfinder (📖 14)
<b>7</b>	button (📖 61, 131)	<b>17</b>	Focus selector lock
<b>8</b>	(OK) button (📖 81)	<b>18</b>	Memory card access lamp (📖 38)
<b>9</b>	Network indicator	<b>19</b>	<b>i</b> button (📖 88)
<b>10</b>	<b>Fn3</b> () button (📖 135)		

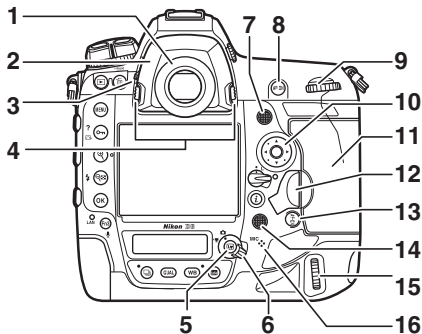

- |  |  |
|--|--|
| <p><b>1</b> Viewfinder eyepiece (☞ 205)</p> <p><b>2</b> Eyepiece adapter (☞ 205)</p> <p><b>3</b> Eyepiece shutter lever (☞ 13)</p> <p><b>4</b> Eyepiece adapter latch (☞ 205)</p> <p><b>5</b> <b>Lv</b> button (☞ 55, 63)</p> <p><b>6</b> Live view selector (☞ 55, 63)</p> <p><b>7</b> Sub-selector</p> <p><b>8</b> <b>AF-ON</b> button (☞ 107)</p> <p><b>9</b> Main command dial</p> <p><b>10</b> Multi selector (☞ 81)</p> <p><b>11</b> Memory card slot cover (☞ 38)</p> | <p><b>12</b> Card slot cover release button cover (☞ 38)</p> <p>Card slot cover release button (under cover; ☞ 38)</p> <p><b>13</b> <b>MC</b> button (☞ 107)</p> <p><b>14</b> Multi selector (vertical)</p> <p><b>15</b> Main command dial (vertical)</p> <p>Speaker</p> <p><b>16</b> Microphone (for voice memos)</p> |
|--|--|

---

### ✔ **The GNSS Antenna**

If possible, stay in the open when using location data services. Keep the antenna pointed to the sky for best reception.

### ✔ **The Connector Covers**

Be sure to close the covers when the connectors are not in use. Foreign matter in the connectors could cause malfunction.

### ✔ **The Speaker**

Close proximity to the speaker could corrupt data stored on magnetic stripe cards or other such magnetic storage devices. Keep magnetic storage devices away from the speaker.

---

### ✔ **The Security Slot**

The security slot serves as an attachment point for third-party anti-theft cables. It is compatible and intended for use with Kensington security cable locks. For more information, see the documentation provided with the security cable lock.

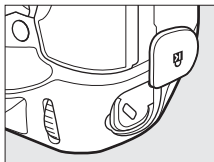

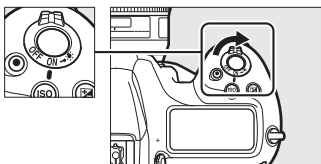

## **The Power Switch**

Rotate the power switch to the “ON” position as shown to turn the camera on. Returning the switch to the “OFF” position turns the camera off.



---

## **✓ The LCD Illuminator**

Rotating the power switch to  activates the backlights for the buttons and control panels (LCD illuminator). The backlights will remain lit for a few seconds after the power switch is released. The backlights turn off when the switch is rotated to  a second time or the shutter is released. Activating the button backlight makes the camera easier to use in the dark.

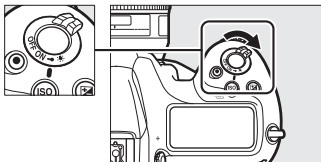

## The Top Control Panel

The following indicators appear in the top control panel at default settings. For a full list of the indicators that may be displayed, see “Camera Displays” (📖 171) in “Technical Notes”.

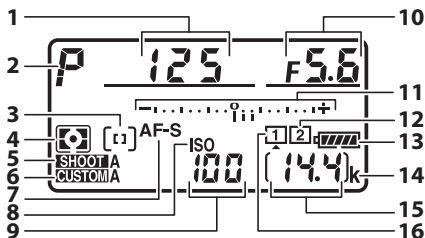

1	Shutter speed	11	Exposure indicator Exposure Exposure compensation (📖 117)
2	Exposure mode (📖 108)	12	Memory card icon (Slot 2; 📖 41, 48)
3	AF-area mode indicator (📖 101)	13	Battery indicator (📖 47)
4	Metering (📖 111)	14	"k" (appears when memory remains for over 1000 exposures; 📖 48)
5	Photo shooting menu bank	15	Number of exposures remaining (📖 48, 258)
6	Custom settings bank	16	Memory card icon (Slot 1; 📖 41, 48)
7	Autofocus mode (📖 98)		
8	ISO sensitivity indicator (📖 114)		
9	ISO sensitivity (📖 114)		
10	Aperture (f-number)		

---

### ✔ Camera Off Display

If the camera is turned off with a battery and memory card inserted, the memory card icon, the number of photos in the current folder (①), and the number of exposures remaining (②) will be displayed in the top control panel. Depending on the memory card, the camera may in rare cases not display this information when a card is inserted. This can be addressed by turning the camera on.

---

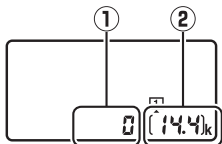



## The Rear Control Panel

The following indicators appear in the rear control panel at default settings. For a full list of the indicators that may be displayed, see “Camera Displays” (📖 174) in “Technical Notes”.

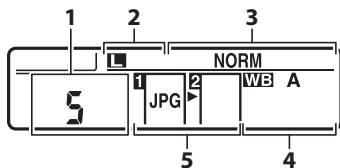

**1** Release mode (📖 109)

**2** Size (JPEG images; 📖 120)

**3** Image quality (📖 118)

**4** White balance (📖 121)

**5** Role played by memory card  
in Slot 2

Image quality (📖 118)

## The Viewfinder

The following indicators appear in the viewfinder at default settings. For a full list of the indicators that may be displayed, see “Camera Displays” (□ 159) in “Technical Notes”.

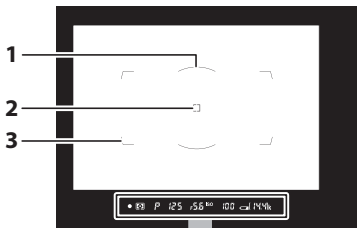

1	12-mm reference circle for center-weighted metering (□ 111)	9	ISO sensitivity indicator (□ 114)
2	Focus points	10	ISO sensitivity (□ 114) AF-area mode (□ 101)
3	AF-area brackets (□ 50)	11	Battery indicator (□ 47)
4	Focus indicator (□ 50)	12	Number of exposures remaining (□ 48, 258)
5	Metering (□ 111)		Number of shots remaining before memory buffer fills
6	Exposure mode (□ 108)		
7	Shutter speed Autofocus mode (□ 98)	13	"k" (appears when memory remains for over 1000 exposures; □ 48)
8	Aperture (f-number)		

---

### **✔ The Viewfinder**

When the battery is exhausted or no battery is inserted, the display in the viewfinder will dim. The display will return to normal when a charged battery is inserted.

### **✔ Temperature Extremes**

The brightness of the control panel and viewfinder displays varies with temperature, and response times may drop when the temperature is low; the displays will return to normal at room temperature.

### **✔ The Viewfinder Eyepiece Shutter**

To prevent light entering via the viewfinder interfering with photographs or exposure, raise the viewfinder eyepiece shutter lever to close the viewfinder eyepiece shutter when taking photos without your eye to the viewfinder.

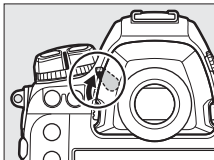

## ☑ The Diopter Adjustment Control

The viewfinder can be focused by lifting and rotating the diopter adjustment control. With your eye to the viewfinder, rotate the diopter control until display in the viewfinder is in sharp focus.

- Corrective lenses (available separately) can be used to further adjust viewfinder diopter.
- After adjusting diopter, push the diopter adjustment control back into its original position.

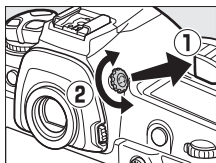

Viewfinder not in focus



Viewfinder in focus

## The Live View Displays (Photos/Movies)

Press the **[Lv]** button to display the view through the lens in the monitor. Rotate the live view selector to **[📷]** to take photographs or to **[🎥]** to record movies.

### ■ Live View Photography

The following indicators appear in the monitor at default settings. For a full list of the indicators that may be displayed, see “Camera Displays” (📖 167) in “Technical Notes”.

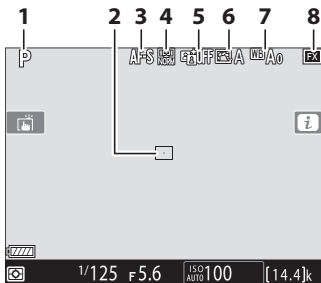

**1** Exposure mode (📖 108)

**2** Focus point

**3** Autofocus mode (📖 98)

**4** AF-area mode (📖 101)

**5** Active D-Lighting

**6** Picture Control (📖 125)

**7** White balance (📖 121)

**8** Image area

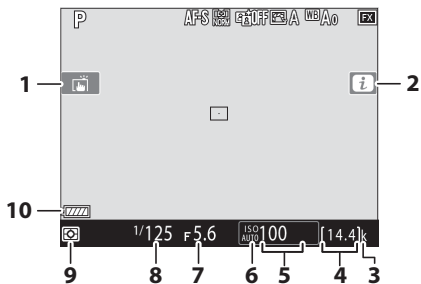

- |          |   |           |                                   |
|----------|---|-----------|-----------------------------------|
| <b>1</b> | Touch shooting (☞ 18)   | <b>5</b>  | ISO sensitivity (☞ 114)           |
| <b>2</b> | <i>i</i> icon (☞ 88)  | <b>6</b>  | ISO sensitivity indicator (☞ 114) |
| <b>3</b> | "k" (appears when memory remains for over 1000 exposures; ☞ 48) | <b>7</b>  | Aperture                          |
| <b>4</b> | Number of exposures remaining (☞ 48, 258)                       | <b>8</b>  | Shutter speed                     |
|          |   | <b>9</b>  | Metering (☞ 111)                  |
|          |   | <b>10</b> | Battery indicator (☞ 47)          |

## ■ Movies

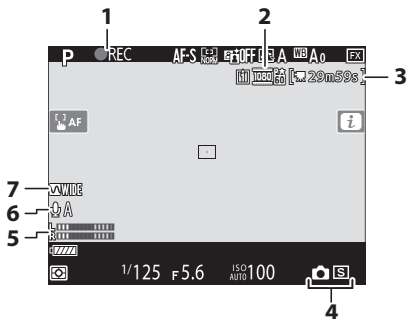

**1** Recording indicator (📖 63)  
"No movie" indicator

**2** Frame size and rate/image  
quality

**3** Time remaining (📖 63)

**4** Release mode (still  
photography; 📖 70)

**5** Sound level (📖 66)

**6** Microphone sensitivity

**7** Frequency response

## Touch Controls

- The touch-sensitive monitor offers a variety of controls that can be operated by touching the display with your fingers.

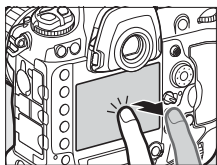

- Touch controls can be used to:
  - Focus and release the shutter (📖 19)
  - Adjust settings (📖 20)
  - View pictures (📖 21)
  - View movies (📖 23)
  - Access the **i** menu (📖 23)
  - Enter text (📖 24)
  - Navigate the menus (📖 25)



## ■ Focusing and Releasing the Shutter

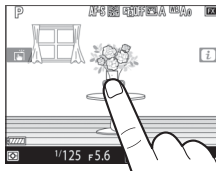

- Touch the monitor during live view to focus on the selected point (touch AF).
- During still photography, the shutter will be released when you lift your finger from the display (touch shutter).
- Touch AF settings can be adjusted by tapping the  icon.



## ■ Adjusting Settings

- Tap highlighted settings in the display.
- You can then choose the desired option by tapping icons or sliders.



- Tap  or press  to select the chosen option and return to the previous display.



## ■ Playback

- Flick left or right to view other pictures during full-frame playback.

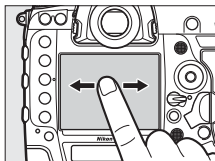

- In full-frame playback, touching the bottom of the display brings up a frame-advance bar. Slide your finger left or right over the bar to scroll rapidly to other pictures.

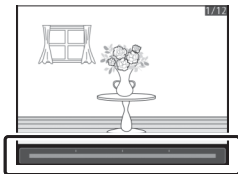
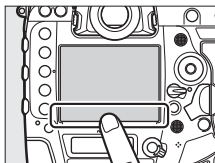

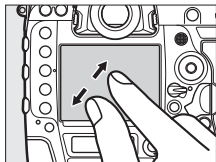

- To zoom in on a picture displayed in full-frame playback, use a stretch gesture or give the display two quick taps. After zooming in, you can adjust the zoom ratio using stretch gestures to zoom in and pinch gestures to zoom out.

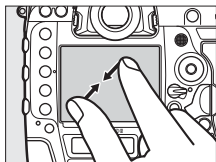

- Use slide gestures to view other parts of the image during zoom.
- Giving the display two quick taps while zoom is in effect cancels zoom.
- To “zoom out” to a thumbnail view, use a pinch gesture in full-frame playback. Use pinch and stretch to choose the number of images displayed from 4, 9, and 72 frames.



## ■ Viewing Movies

- Movies are indicated by a  icon; to start playback, tap the on-screen guide.
- Tap the display to pause. Tap again to resume.
- Tap  to exit to full-frame playback.

## ■ The *i* Menu

When the *i* menu ( 88) is displayed, you can tap items to view options.

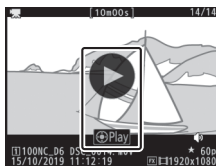

## ■ Text Entry

- When a keyboard is displayed, you can enter text by tapping the keys.



- 1 Text display area
- 2 Keyboard area
- 3 Keyboard selection

- To position the cursor, tap ◀ or ▶ or tap directly in the text display area.
- To cycle through the upper- and lower-case and symbol keyboards, tap the keyboard selection button.

## ■ Navigating the Menus

- After pressing the **MENU** button to display the menus, you can slide up or down to scroll.

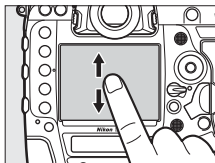

- Tap a menu icon to choose a menu.

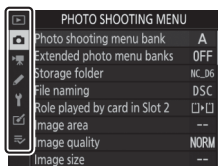

- Tap menu items to display options. You can then choose the desired option by tapping icons or sliders.

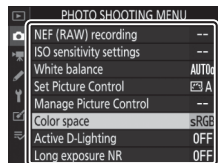

- To exit without changing settings, tap .

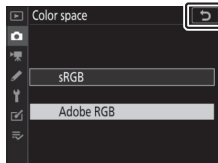

---

## ✔ The Touch Screen

- The touch screen responds to static electricity. It may not respond when touched with fingernails or gloved hands. For improved response when using the touch screen with gloves, select **[Enabled]** for **[Touch controls]** > **[Glove mode]** in the setup menu.
  - Do not touch the screen with sharp objects.
  - Do not use excessive force.
  - The screen may not respond when covered with third-party protective films.
  - The screen may not respond when touched simultaneously in multiple locations.
- 

## ✔ Enabling or Disabling Touch Controls

Touch controls can be enabled or disabled using the **[Touch controls]** item in the setup menu.

---



# First Steps

## Readying the Camera

### Attaching the Strap

To attach a strap (whether the supplied strap or one that has been purchased separately):

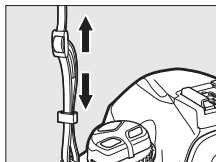
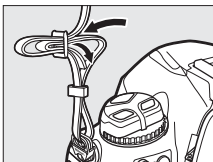
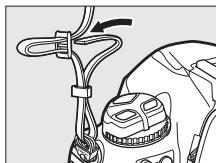
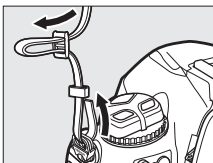

## **Charging the Battery**

Charge the supplied EN-EL18c battery in the supplied MH-26a battery charger before use. An exhausted battery will fully charge in about two hours and 35 minutes.

### **✔ The Battery and Charger**

Read and follow the warnings and cautions in "For Your Safety" (□ xviii) and "Caring for the Camera and Battery: Cautions" (□ 223).

#### **1 Connect the power cable to the charger.**

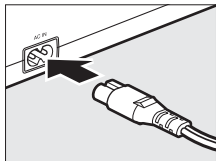

#### **2 Plug the charger in.**

#### **3 Remove the battery terminal cover.**

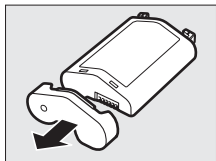

## 4 Remove the contact protector.

Slide the contact protector from the charger as shown.

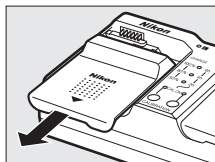

## 5 Charge the battery.

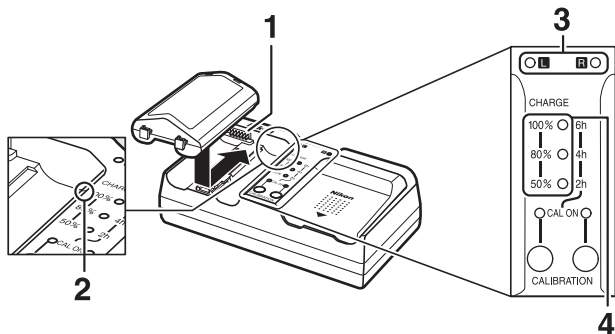

- 1 Contacts
- 2 Guide
- 3 Chamber lamps
- 4 Charge lamps (green)

- Insert the battery (terminals first), aligning the end of the battery with the guide and then sliding the battery in the direction indicated until it clicks into place.
- The lamp for the chamber containing the battery (“L” or “R”) will start to flash as charging begins.
- Charging is complete when the chamber lamp stops flashing and the charge lamps turn off.
- Battery status is shown by the chamber and charge lamps:

		Charge state			
		<50%	≥50%, <80%	≥80%, <100%	100%
<b>Chamber lamp</b>		☼ (flashes)	☼ (flashes)	☼ (flashes)	○ (on)
<b>Charge lamps</b>	<b>100%</b>	● (off)	● (off)	☼ (flashes)	● (off)
	<b>80%</b>	● (off)	☼ (flashes)	○ (on)	● (off)
	<b>50%</b>	☼ (flashes)	○ (on)	○ (on)	● (off)

---

## 6 Remove the battery and unplug the charger when charging is complete.

---

### ✔ Calibration

For information on calibrating batteries to ensure the accuracy of the battery level displays, see “Calibrating Batteries” (📖 252).

### ✔ Warning Indicators

If the MH-26a chamber and charge lamps flash on and off in sequence, take the steps described below.

- **If no battery inserted:** There is a problem with the charger. Unplug the charger and consult a Nikon-authorized service representative.
  - **If a battery is inserted:** A problem has occurred with the battery or charger during charging. Remove the battery, unplug the charger, and consult a Nikon-authorized service representative.
-

## Inserting the Battery

Turn the camera off before inserting or removing the battery.

### **1 Remove the BL-6 battery-chamber cover.**

Lift the battery-chamber cover latch, turn it to the open (⊞) position (①) and remove the battery-chamber cover (②).

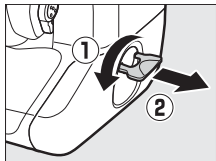

### **2 Attach the cover to the battery.**

- If the battery release is positioned so that the arrow (◀) is visible, slide the battery release to cover the arrow (◀).
- Insert the two projections on the battery into the matching slots in the cover as shown. The battery release will slide aside to completely reveal the arrow (◀).

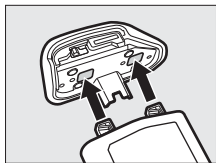
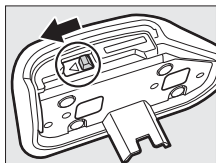

### 3 Insert the battery.

Insert the battery fully and securely as shown.

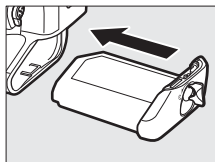

### 4 Latch the cover.

- Rotate the latch to the closed position (①) and fold it down as shown (②).

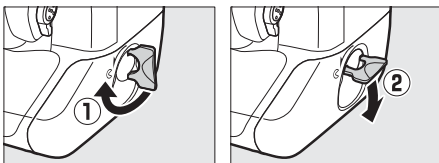

- Be sure the cover is securely latched to prevent the battery from becoming dislodged during operation.

## ■ Removing the Battery

Before removing the battery, turn the camera off, lift the battery-chamber cover latch, and turn it to the open (☞) position.

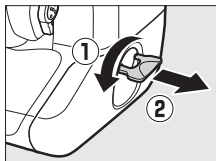

---

### ☑ Removing the Battery-Chamber Cover

To unlatch the battery-chamber cover so that it can be removed from the battery, slide the battery release in the direction indicated by the arrow (◀) until it stops.

### ☑ The Battery-Chamber Cover

- Use BL-6 battery-chamber covers only; other battery-chamber covers cannot be used with this camera.
  - The battery can be charged with the cover attached.
  - To prevent dust accumulating inside the battery chamber, replace the battery-chamber cover on the camera when the battery is not inserted.
-



## **Attaching a Lens**

- The lens generally used in this manual for illustrative purposes is an AF-S NIKKOR 50mm f/1.4G.
- Be careful to prevent dust entering the camera.
- Confirm that the camera is off before attaching the lens.
  - Remove the camera body cap (①, ②) and rear lens cap (③, ④).

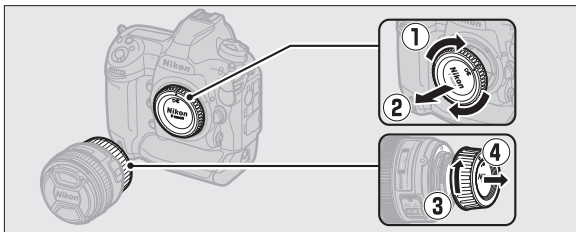

- Align the mounting marks on the camera (⑤) and lens (⑥).

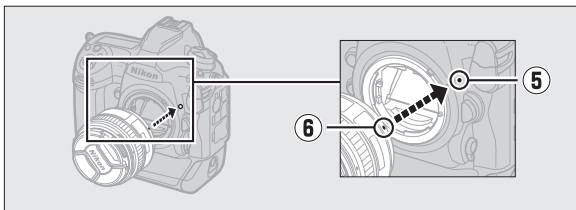

- Rotate the lens as shown until it clicks into place (7, 8).

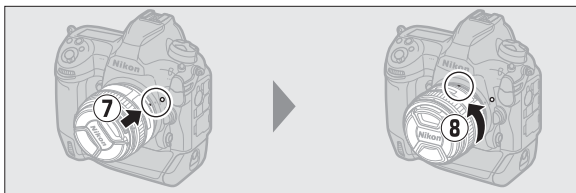

- Remove the lens cap before taking pictures.

---

### ✓ CPU Lenses with Aperture Rings

When using a CPU lens equipped with an aperture ring (🗨 182), lock aperture at the minimum setting (highest f-number).

### ✓ Lens Focus Mode

If the lens is equipped with a focus mode switch, select autofocus mode (A, M/A, or A/M).



### ✓ Image Area

The DX format image area is automatically selected when a DX lens is attached.



## ■ Detaching Lenses

- After turning the camera off, press and hold the lens release button (①) while turning the lens in the direction shown (②).
- After removing the lens, replace the lens caps and camera body cap.

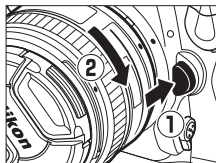

## Inserting Memory Cards

The camera is equipped with two memory card slots: Slot 1 (①) and Slot 2 (②), allowing simultaneous use of two memory cards.

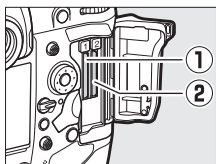

- Turn the camera off before inserting or removing memory cards.
- Do not push on the memory card while pressing the eject button. Failure to observe this precaution could damage the camera or memory card.

### **1** Open the card slot cover.

Open the door protecting the card-slot cover release button (①) and press the release button (②) to open the card slot (③).

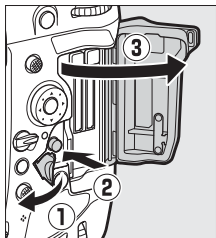

---

## 2 Insert the memory card.

*Inserting a card upside down or backwards could damage the camera or the card. Check to be sure that the card is in the correct orientation.*

Holding the card with the rear label toward the monitor, slide it all the way into the slot. When the memory card is fully inserted, the eject button (①) will pop up and the green memory card access lamp (②) will light briefly.

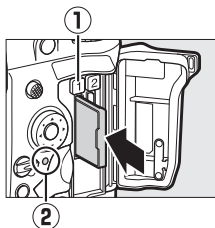

---

## 3 Close the card slot cover.

If this is the first time the memory card will be used after being used or formatted in another device, format the card in the camera before proceeding.

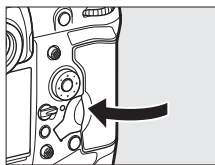

---

## 🗒 Two Memory Cards

When two memory cards are inserted (one in each of Slots 1 and 2), the role played by the card in Slot 2 can be selected using **[Role played by card in Slot 2]** in the photo shooting menu.

- **[Overflow]**: Pictures will be recorded to the card in Slot 2 only when the card in Slot 1 is full.
- **[Backup]**: Two identical copies are recorded, one to each memory card and each with the same image quality and size.
- **[RAW Slot 1 - JPEG Slot 2]**: The NEF (RAW) copies of photos taken at settings of NEF (RAW) + JPEG are recorded only to the card in Slot 1, the JPEG copies only to the card in Slot 2.
- **[JPEG Slot 1 - JPEG Slot 2]**: Two JPEG copies are recorded, one to each memory card, but at different sizes.

---

## ■ Removing Memory Cards

After confirming that the memory card access lamp is off, turn the camera off and open the memory card slot cover. Press the eject button (①) to partially eject the card (②); the memory card can then be removed by hand.

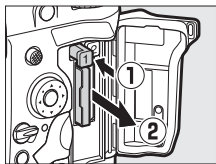

## ✔ Memory Cards

- Memory cards may be hot after use. Observe due caution when removing memory cards from the camera.
- Do not perform the following operations during formatting or while data are being recorded, deleted, or copied to a computer or other device. Failure to observe these precautions could result in loss of data or in damage to the camera or card.
  - Do not remove or insert memory cards
  - Do not turn the camera off
  - Do not remove the battery
  - Do not disconnect AC adapters
- Do not touch the card terminals with your fingers or metal objects.
- Do not use excessive force when handling memory cards. Failure to observe this precaution could damage the card.
- Do not bend or drop memory cards or subject them to strong physical shocks.
- Do not expose memory cards to water, heat, or direct sunlight.
- Do not format memory cards in a computer.

## ✔ Memory Card Icons

The memory card icons in the top control panel light when memory cards are inserted (the example in the illustration shows the display when two memory cards are inserted).

If the memory card is full or an error has occurred, the icon for the affected card will flash.

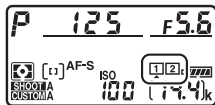

## ✔ No Memory Card Inserted

If no memory card is inserted, the exposure count displays in the viewfinder and top control panel will show (-E-). If the camera is turned off with a battery and no memory card inserted, (-E-) will be displayed in the top control panel.





## Camera Setup

The language option in the setup menu is automatically highlighted the first time menus are displayed. Choose a language and set the camera clock.

### 1 Turn the camera on.

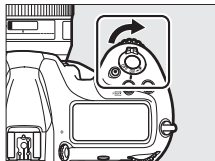

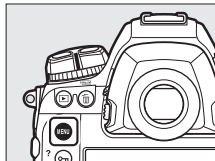

### 2 Highlight [Language] in the setup menu and press .

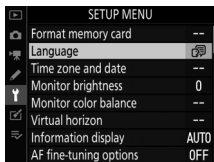

- The **[Language]** item is automatically highlighted in the setup menu the first time the **MENU** button is pressed after purchase.
- For information on using the menus, see “Using the Menus” (📖 81).



### 3 Select a language.

Press  or  to highlight the desired language and press  (the languages available vary with the country or region in which the camera was originally purchased).

### 4 Highlight [Time zone and date] and press .

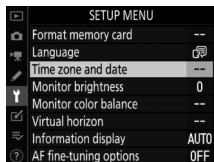

### 5 Choose a time zone.

- Select [**Time zone**] in the [**Time zone and date**] display.
- Highlight a time zone in the [**Time zone**] display and press .
- The display shows a time zone map listing the selected cities in the chosen zone and the difference between the time in the chosen zone and UTC.

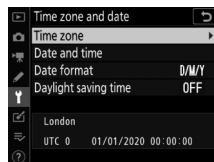

## 6 Turn daylight saving time on or off.

- Select [**Daylight saving time**] in the [**Time zone and date**] display.
- Highlight [**On**] (daylight saving time on) or [**Off**] (daylight saving time off) and press **OK**.
- Selecting [**On**] advances the clock one hour; to undo the effect, select [**Off**].

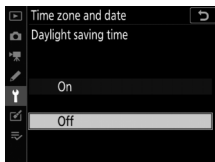

## 7 Set the clock.

- Select [**Date and time**] in the [**Time zone and date**] display.
- Press **OK** after using the multi-selector to set the clock to the date and time in the selected time zone (note that the camera uses a 24-hour clock).

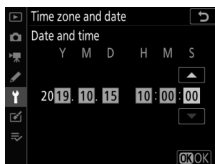

## 8 Choose a date format.

- Select [**Date format**] in the [**Time zone and date**] display.
- Highlight the desired date (year, month, and day) display order and press **OK**.

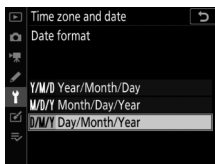

---

## 9 Exit the menus.

Lightly press the shutter-release button halfway to exit to shooting mode.



---

### ☑ The Clock Battery

The camera clock is powered by a separate, non-rechargeable CR1616 lithium battery with a life of about two years. When this battery is low, a  icon will be displayed in the top control panel while the standby timer is on, indicating that it is time to purchase a replacement. For information on replacing the clock battery, see “Replacing the Clock Battery” (📖 221).

---

### ☑ Setting the Clock via GNSS

To record your location and the current UTC (Universal Coordinated Time), select [On] for [Location data (built-in)] > [Record location data]. To set the camera clock to the time supplied by the built-in GNSS receiver, select [Yes] for [Location data (built-in)] > [Set clock from satellite].

### ☑ SnapBridge

Use the SnapBridge app to synchronize the camera clock with the clock on a smartphone or tablet (smart device). See SnapBridge online help for details.



# The Battery Level and Number of Exposures Remaining

Before taking photographs, check the battery level and number of exposures remaining.

## Battery Level

Check the battery level before taking photographs. The battery level is shown in the top control panel and viewfinder.

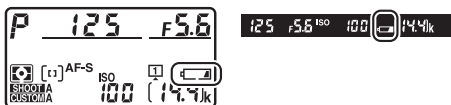

Top control panel	Viewfinder	Description
	—	Battery fully charged.
	—	Battery partially discharged.
	—	
	—	
		Low battery. Charge battery or ready spare battery.
 (flashes)	 (flashes)	Shutter release disabled. Charge or exchange battery.

## Memory Card Indicators and Number of Exposures Remaining

The top control panel and viewfinder show the number of additional photographs that can be taken at current settings (i.e, the number of exposures remaining).



- The top control panel shows the slot or slots that currently hold a memory card (the example shows the icons displayed when cards are inserted in both slots).
- At default settings, **[Overflow]** is selected for **[Role played by card in Slot 2]** in the photo shooting menu. When two memory cards are inserted, pictures will first be recorded to the card in Slot 1, switching to Slot 2 when the card in Slot 1 is full.

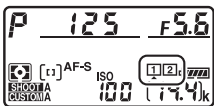

- If two memory cards are inserted, the camera will show the number of additional photographs that can be recorded to the card in Slot 1. When the card in Slot 1 is full, the display will show the number of exposures remaining on the card in Slot 2.
- Values over 1000 are rounded down to the nearest hundred. For example, values in the vicinity of 1400 are shown as 1.4 k.
- If the memory card is full or a card error has occurred, the icon for the affected slot will flash.

# Basic Photography and Playback

## Taking Photographs

Photographs can be framed in the viewfinder (viewfinder photography) or in the monitor (live view photography).

### Framing Photographs in the Viewfinder (Viewfinder Photography)

#### 1 Ready the camera.

Holding the handgrip in your right hand and cradling the camera body or lens with your left, bring your elbows in against the sides of your chest.





## 2 Frame the photograph.

- Frame a photograph in the viewfinder.
- Position the main subject in the AF-area brackets.

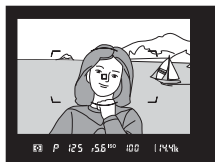

## 3 Press the shutter-release button halfway to focus.

- The in-focus indicator (●) will appear in the viewfinder when the focus operation is complete.

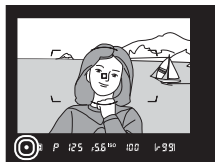

Viewfinder display	Description
● (steady)	The subject is in focus.
▶ (steady)	The focus point is in front of the subject.
◀ (steady)	The focus point is behind the subject.
▶ ◀ (flashes)	The camera is unable to focus using autofocus.

- You can also focus by pressing the **AF-ON** button.

---

**4 Smoothly press the shutter-release button the rest of the way down to take the photograph.**

The memory card access lamp will light while the photograph is being recorded. *Do not eject the memory card or remove or disconnect the power source until the lamp has gone out and recording is complete.*

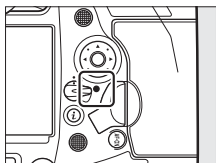

## The Standby Timer (Viewfinder Photography)

The camera uses a standby timer to help reduce the drain on the battery. The timer starts when the shutter-release button is pressed halfway and expires if no operations are performed for about 6 seconds. The viewfinder display and the shutter speed and aperture indicators in the top control panel turn off when the timer expires. To restart the timer and restore the displays, press the shutter-release button halfway a second time. The length of time before the standby timer expires can be adjusted using Custom Setting c2 [Standby timer].

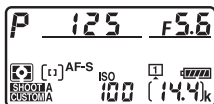

Standby timer on

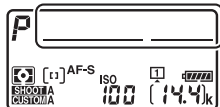

Standby timer off

## ☑ Framing Photos in Portrait (“Tall”) Orientation

The camera is equipped with controls for use in portrait (“tall”) orientation, including vertical shutter-release, **Fn**, and **AF-ON** buttons, main and sub-command dials, and a multi selector.



- Rotate the vertical shooting shutter-release button lock to **L** to avoid accidentally operating these controls when the camera is in landscape (“wide”) orientation.

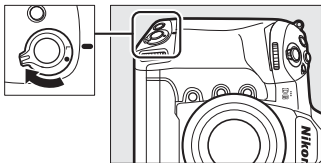

## Framing Photographs in the Monitor (Live View)

- 1 Rotate the live view selector to  (live view photography).**

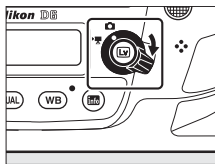

- 2 Press the  button.**

- The mirror will be raised and live view will start. The viewfinder will go dark and the view through the lens will be displayed in the monitor.
- During live view, exposure for movies and photographs can be previewed in the monitor.

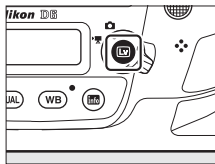

---

### 3 Ready the camera.

Hold the handgrip securely in your right hand and cradle the camera body or lens with your left.



---

### 4 Frame the photograph.

Position the subject near the center of the frame.

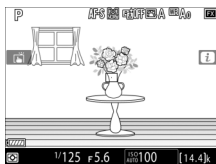

## 5 Press the shutter-release button halfway to focus.



- Focus locks while the shutter-release button is pressed halfway.
- If the camera is able to focus, the focus point will be displayed in green. If the camera is unable to focus, for example because the subject is too close to the camera, the focus point will flash red.

- To preview exposure in the monitor as shown in the illustration (exposure preview), press the **OK** button. You can preview how the settings selected for shutter speed, aperture, and ISO sensitivity affect exposure during shooting. Exposure compensation can be adjusted by  $\pm 5$  EV, although only values between  $-3$  and  $+3$  EV are reflected in the preview display.

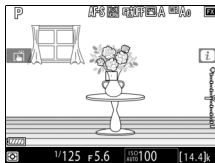

---

**6 Press the shutter-release button the rest of the way down to take the photograph.**

The monitor turns off during shooting.



---

**7 Press the  button to exit live view.**

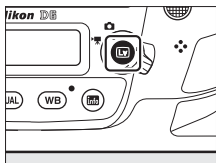



---

## ✔ Shooting in Live View

- Although these effects are not visible in the final pictures, during live view you may notice the following in the monitor:
  - Moving objects in the display appear distorted (individual subjects such as trains or cars moving at high speed through the frame may be distorted, or the entire frame may appear distorted when the camera is panned horizontally)
  - Jagged edges, color fringing, *moiré*, and bright spots may appear in the display
  - Bright regions or bands may appear in scenes lit by flashing signs and other intermittent light sources or when the subject is briefly illuminated by a strobe or other bright, momentary light source
- Flicker and banding visible in the monitor under fluorescent, mercury vapor, or sodium lamps can be reduced using the **[Flicker reduction]** item in the movie shooting menu, although they may still be visible in photographs taken at some shutter speeds.
- To prevent light entering via the viewfinder interfering with photographs or exposure, raise the viewfinder eyepiece shutter lever to close the viewfinder eyepiece shutter.
- When shooting in live view, avoid pointing the camera at the sun or other bright light sources. Failure to observe this precaution could result in damage to the camera's internal circuitry.
- Regardless of the option selected for Custom Setting c2 [**Standby timer**], the standby timer will not expire during live view.

## ☑ The Count-Down Display

A count down will appear in the top left corner of the display approximately 30 s before live view ends automatically.

- If the timer has been triggered by Custom Setting c4 [**Monitor off delay**], the count down will be displayed in black starting 30 s before the timer expires, switching to red when there are only 5 s to go. If [**No limit**] is selected for [**Monitor off delay**] > [**Live view**], the camera may nevertheless terminate live view as necessary to protect its internal circuits from high temperatures and the like.
- A count down will be displayed in red starting 30 s before the camera shuts down to protect its internal circuits. Depending on shooting conditions, the timer may appear immediately when live view is selected.

## ☑ Exposure Preview



- Exposure preview is not available when **b u l b** (Bulb) or **- -** (Time) is selected for shutter speed. The preview may not accurately reflect the final results when:
    - Flash lighting is used
    - [**Active D-Lighting**] or [**HDR (high dynamic range)**] is in effect
    - [**A**] (auto) is selected for the Picture Control [**Contrast**] parameter (☐ 128)
    - **x 25 a** is selected for shutter speed
    - Bracketing is in effect
  - If the subject is very bright or very dark, the exposure indicators will flash to warn that the preview may not accurately reflect exposure.
-

## Touch Controls

Touch controls can be used in place of the shutter-release button to focus and take pictures during live view photography (📖 19).

## Live View Zoom Preview

Press the  button to magnify the view in the monitor up to a maximum of about 11×.

- Press  to zoom in,  to zoom out.
- A navigation window will appear in a gray frame at the bottom right corner of the display.
- Use the multi selector to scroll to areas of the frame not visible in the monitor.

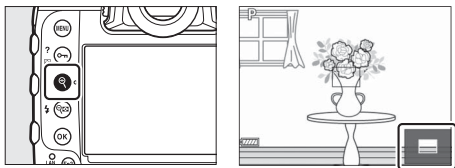

## **Previewing Focus During Live View**

To temporarily select maximum aperture for an improved focus preview during live view, press the **Pv** button. To return aperture to its original value, press the **Pv** button again or focus using autofocus. If the shutter-release button is pressed all the way down to take a picture during focus preview, aperture will return to the original value before the photo is taken. The maximum aperture icon (⊙) is displayed while maximum aperture is selected.

---

# Recording Movies

Live view can be used to record movies.

## 🔪 “Filming” Versus “Recording”

Throughout this manual, the terms “filming” and “recording” are used as follows: “filming” is used if the live view selector is rotated to , while “recording” refers to the act of shooting footage using the movie-record button.

### 1 Rotate the live view selector to (movie live view).

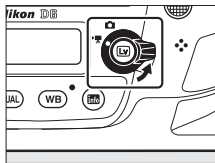

### 2 Press the button.

- The mirror will be raised and live view will start. The viewfinder will go dark and the view through the lens will be displayed in the monitor.
- During live view, exposure for movies and photographs can be previewed in the monitor.

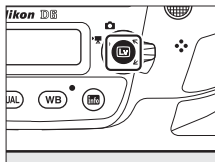

---

### **3 Press the AF-ON button to focus.**

- Focus before beginning recording.
- Focus can be adjusted by tapping your subject in the monitor.

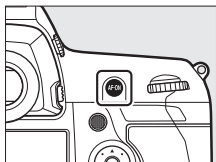

---

### **4 Press the movie-record button to start recording.**

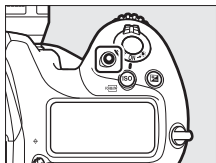

- A recording indicator will be displayed in the monitor. The monitor also shows the time remaining, or in other words the approximate amount of new footage that can be recorded to the memory card.

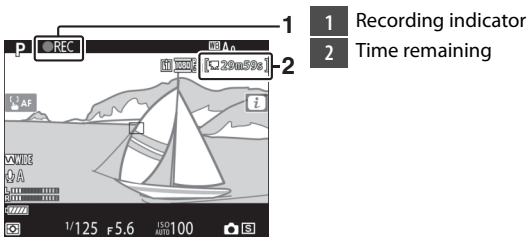

- The camera can be refocused during recording by pressing the **AF-ON** button or by tapping your subject in the monitor.
- Sound is recorded via the built-in microphone for movie recording. Do not cover the microphone during recording.
- Exposure can be altered by up to  $\pm 3$  EV using exposure compensation.

**5 Press the movie-record button again to end recording.**

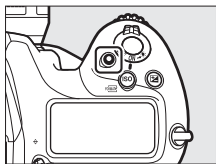

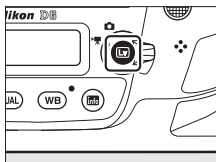

**6 Press the  button to exit live view.**



**☑ Recording Movies**

- When filming movies, you may notice the following in the display. These phenomena will also be visible in any footage recorded with the camera.
  - Flicker or banding in scenes lit by such sources as fluorescent, mercury vapor, or sodium lamps
  - Distortion associated with motion (individual subjects such as trains or cars moving at high speed through the frame may be distorted, or the entire frame may appear distorted when the camera is panned horizontally)





- Jagged edges, color fringing, *moiré*, and bright spots in the display
- Bright regions or bands in scenes lit by flashing signs and other intermittent light sources or when the subject is briefly illuminated by a strobe or other bright, momentary light source
- Flicker occurring while power aperture is in use
- Note that noise (randomly-spaced bright pixels, fog, or lines) and unexpected colors may appear if you use the  button to zoom in on the view through the lens ( 69) during filming.
- Movie recording will end automatically if:
  - The maximum length is reached
  - The live view selector is rotated to another setting
  - The lens is removed
- When recording movies, avoid pointing the camera at the sun or other strong light sources. Failure to observe this precaution could result in damage to the camera's internal circuitry.
- Sounds made by the camera may be audible in footage recorded:
  - During autofocus
  - When power aperture is used
  - During aperture adjustment
  - With vibration reduction enabled on vibration reduction (VR) lenses
- If the sound level is displayed in red, the volume is too high. Adjust microphone sensitivity.

## ✔ The Count-Down Display

A count down will appear in the top left corner of the display approximately 30 s before live view ends automatically.

- If the timer has been triggered by Custom Setting c4 [**Monitor off delay**], the count down will be displayed in black starting 30 s before the timer expires, switching to red when there are only 5 s to go. If [**No limit**] is selected for [**Monitor off delay**] > [**Live view**], the camera may nevertheless terminate live view as necessary to protect its internal circuits from high temperatures and the like.
- A count down will be displayed in red starting 30 s before the camera shuts down to protect its internal circuits. Depending on shooting conditions, the timer may appear immediately when live view is selected.
- Note that regardless of the time available (displayed in the top right corner of the monitor), live view and movie recording will end automatically when the count-down timer expires.

## ✔ Adjusting Settings During Movie Recording





- Headphone volume cannot be adjusted during recording.
  - If an option other than  (microphone off) is currently selected, microphone sensitivity can be changed while recording is in progress.  cannot be selected.
-

---

### **Focusing During Movie Recording**

Focus can also be adjusted by pressing the shutter-release button halfway.

### **Live View Zoom Preview**

Press the  button to zoom in on the view in the monitor ( 61). For a 100% zoom ratio during recording, press the  button. Press   to restore the previous zoom ratio.

---

## Taking Photos During Filming

Photos can be taken during filming by pressing the shutter-release button all the way down. The resulting photo will have an aspect ratio of 16:9.



- A  icon will flash in the display when a photo is taken.
- Photos can be taken while recording is in progress. Taking photos does not interrupt movie recording.

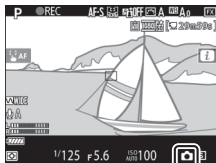

---

### Taking Photos During Filming

- Note that photos can be taken even when the subject is not in focus.
  - Photos are recorded at the dimensions currently selected for movie frame size.
  - Photos are recorded in [**JPEG fine★**] format, regardless of the option selected for image quality.
  - Photos are recorded to the card in the slot selected for [**Destination**] in the movie shooting menu.
  - The frame advance rate for continuous release modes varies with the option selected for [**Frame size/frame rate**]. While recording is in progress, only one photo will be taken each time the shutter-release button is pressed.
  - Up to 50 photographs can be taken with each movie.
  - Photographs taken during filming will not be displayed automatically after shooting even if [**On**] is selected for [**Image review**] in the playback menu.
-

# Playback

Press the  button to view photos and movies recorded with the camera.

## 1 Press the button.

- A picture will be displayed in the monitor.
- The memory card containing the picture currently displayed is shown by an icon.

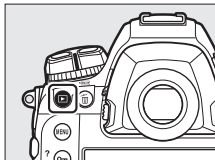

## 2 Press or to view additional pictures.

- Additional pictures can also be viewed by flicking a finger left or right over the display ( 21).
- To end playback and return to shooting mode, press the shutter-release button halfway.

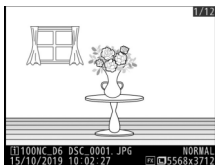



---

## **Image Review**



When **[On]** is selected for **[Image review]** in the playback menu, pictures are automatically displayed in the monitor after shooting without the user pressing the  button.

---



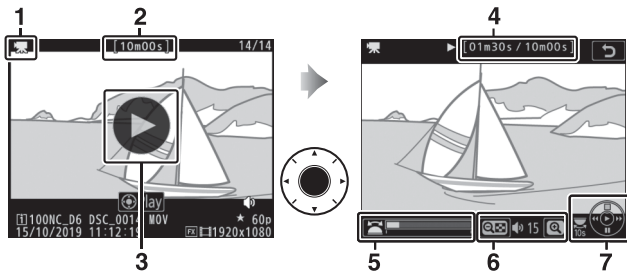









## Viewing Movies

Movies are indicated by a  icon. Tap the  icon in the display or press the center of the multi selector to start playback (a progress bar shows your approximate position in the movie).

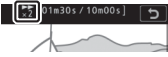
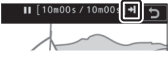

- 1  icon
- 2 Length
- 3  icon
- 4 Current position/total length
- 5 Progress bar
- 6 Volume
- 7 Guide

## Movie Playback Operations

To	Description
<b>Pause</b>	Press  to pause playback.
<b>Resume</b>	Press the center of the multi selector to resume playback when playback is paused or during rewind/advance.
<b>Rewind/advance</b>	<ul style="list-style-type: none"> <li>Press  to rewind,  to advance. Speed increases with each press, from 2x to 4x to 8x to 16x.</li> <li>Keep  or  pressed to skip respectively to the first frame or last frame.</li> <li>The first frame is indicated by a  in the top right corner of the display, the last frame by a .</li> </ul>  
<b>Start slow-motion playback</b>	Press  while the movie is paused to start slow-motion playback.
<b>Jog rewind/advance</b>	<ul style="list-style-type: none"> <li>Press  or  while the movie is paused to rewind or advance one frame at a time.</li> <li>Keep  or  pressed for continuous rewind or advance.</li> </ul>
<b>Skip 10 s</b>	Rotate the main command dial one stop to skip ahead or back 10 s.
<b>Skip to last or first frame</b>	If the movie contains no indices, you can skip to the first or last frame by rotating the sub-command dial.



To	Description
<b>Skip to index</b>	If the movie contains indices, rotating the sub-command dial takes you to the next or previous index. <ul style="list-style-type: none"> <li>Indices can be added or removed from the <b>[EDIT MOVIE]</b> menu, which can be displayed by pausing playback and pressing the <b>i</b> button.</li> </ul>
<b>Adjust volume</b>	Press <b>Q</b> to increase volume, <b>Q</b> <b>⚡</b> to decrease.
<b>Trim movie</b>	To display the <b>[EDIT MOVIE]</b> menu, pause playback and press the <b>i</b> button.
<b>Exit</b>	Press <b>⏪</b> or <b>▶</b> to exit to full-frame playback.
<b>Exit to shooting mode</b>	Press the shutter-release button halfway to exit playback and return to shooting mode.

## Indices



Indices can be added when playback is paused by pressing the **i** button and selecting **[Add index]**. You can quickly jump to indexed locations during playback and editing. The presence of indices is indicated by a **i** icon in the full-frame playback display.



## Deleting Unwanted Pictures



Pictures can be deleted as described below. *Note that once deleted, pictures cannot be recovered.*

### 1 Display the picture.

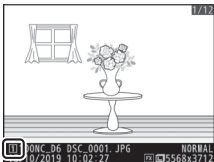
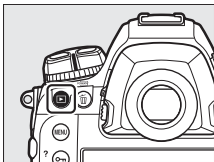
- Press the  button to start playback and press  or  until the desired picture is displayed.
- The location of the current image is shown by an icon at the bottom left corner of the display.



### 2 Delete the picture.

- Press the  (FORMAT) button; a confirmation dialog will be displayed. Press the  (FORMAT) button again to delete the image and return to playback.
- To exit without deleting the picture, press .

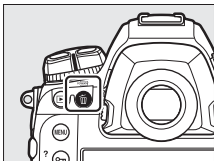

## Uploading Pictures

You can upload your pictures to smartphones or tablets (smart devices) or computers. Options for doing so are listed below. For more information, see the following in the Reference Manual: “Connecting to Computers and TVs”, “Built-in Wireless”, and “Ethernet/WT-6”.

### Uploading Pictures to Smart Devices

Use the SnapBridge app to upload pictures using the camera’s built-in Wi-Fi or Bluetooth.



### Uploading Pictures to a Computer or FTP Server

Several options are available for uploading pictures to computers.

#### ■ ■ Built-in Wi-Fi

Use the camera’s built-in Wi-Fi to upload pictures to a computer via a wireless connection.



## ■ The WT-6 Wireless Transmitter

Use the optional WT-6 wireless transmitter to connect to wireless networks and upload pictures to computers or ftp servers. The WT-6 offers more reliable wireless connections than the camera's built-in Wi-Fi.



## ■ Ethernet

Connect to networks using an Ethernet cable attached to the camera's Ethernet connector and upload pictures to computers or ftp servers.



## ■ USB

Connect the camera to a computer using a USB cable and transfer pictures using the NX Studio computer application.

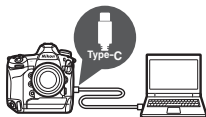

---

### **✔ The Wireless Transmitter Utility**

You will need Wireless Transmitter Utility computer software when uploading pictures to a computer via the camera's built-in Wi-Fi, the WT-6, or an Ethernet connection.

### **✔ The SnapBridge App and Computer Applications**

- The SnapBridge app is available from the Apple App Store® and on Google Play™.
- Nikon computer software is available from the Nikon Download Center. Check the version and system requirements and be sure to download the latest version.

<https://downloadcenter.nikonimglib.com/>

---

# Camera Controls

## The MENU Button

Press the **MENU** button to view the menus.

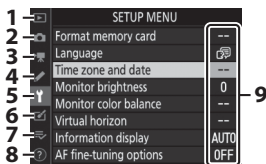
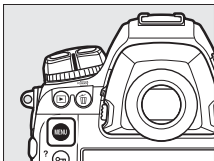

- 1 [PLAYBACK MENU]
- 2 [PHOTO SHOOTING MENU]
- 3 [MOVIE SHOOTING MENU]
- 4 [CUSTOM SETTING MENU]
- 5 [SETUP MENU]
- 6 [RETOUCH MENU]
- 7 [MY MENU] / [RECENT SETTINGS] \*
- 8 Help icon
- 9 Current settings

\* You can choose the menu displayed. The default is [MY MENU].

## Using the Menu

You can navigate the menu using the multi selector and **OK** button.

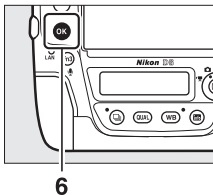
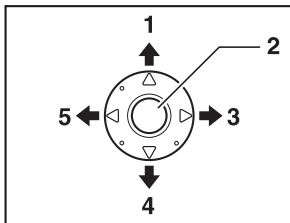

**1** Move cursor up

**2** Center of multi selector: select highlighted item

**3** Display sub-menu, select highlighted item, or move cursor right

**4** Move cursor down

**5** Cancel and return to previous menu, or move cursor left

**6** **OK** button: select highlighted item

### 1 Highlight the icon for the current menu.

Press **OK** to highlight the icon for the current menu.

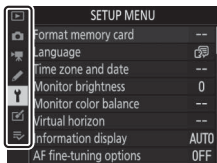

---

## 2 Select a menu.

Press  or  to select the desired menu.

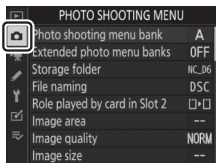

---

## 3 Position the cursor in the selected menu.

Press  to position the cursor in the selected menu.

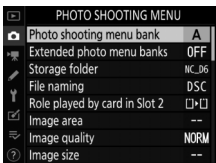



---

## 4 Highlight a menu item.

Press  or  to highlight a menu item.

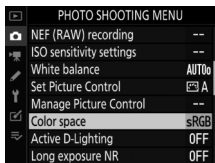

---

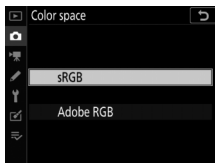

## 5 Display options.

Press  to display options for the selected menu item.



---

## 6 Highlight an option.

Press  or  to highlight an option.

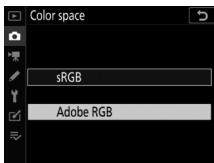

---

## 7 Select the highlighted option.

- Press .
- To exit without making a selection, press the **MENU** button.
- To exit the menus and return to shooting mode, press the shutter-release button halfway.

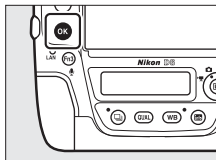

## ✔ The **OK** Button

While pressing **OK** or the center of the multi selector generally has the same effect as pressing **OK**, there are some items for which selection can only be made by pressing **OK**.

## ✔ Grayed-Out Items

- Some items and menu options may be unavailable depending on camera status. Unavailable items are displayed in gray.
- In some cases, pressing **OK** when a grayed-out item is highlighted will display a message explaining why the item is unavailable.

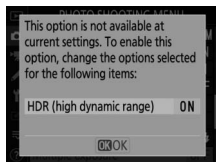

## ☑ Text Entry

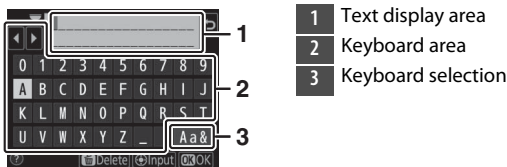

A keyboard is displayed when text entry is required. Enter text as described below.







- Enter characters at the current cursor position by highlighting them with the multi selector arrow keys and then pressing the center of the multi selector.
  - To move the cursor left or right in the text display area, rotate the main command dial.
  - To cycle through the upper- and lower-case and symbol keyboards, highlight the keyboard selection icon and press the center of the multi selector. The keyboard selection icon may not be available in some cases.
  - If a character is entered when the text display area is full, the rightmost character will be deleted.
  - To delete the character under the cursor, press the (FORMAT) button.
  - To complete entry, press **OK**.
  - To exit without completing text entry, press **MENU**.
-

---

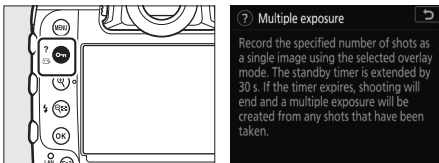
## The (Help) Icon

- Where available, a description of the currently-selected item can be viewed by pressing the  (/?)



- Press  or  to scroll.
- Press  (/?)

## Touch Controls

You can also navigate the menus using touch controls (□ 25).

---

## The *i* Button (the *i* Menu)

For quick access to frequently-used settings, press the *i* button or tap the *i* icon in the live-view display to view the *i* menu.

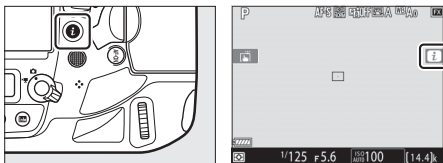

- Highlight items using the multi selector and press the center of the multi selector to view options. Highlight the desired option and press the center of the multi selector to select and return to the *i* menu.

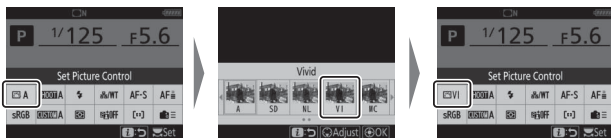

- To cancel and return to the previous display, press the *i* button.
- Different menus are displayed during viewfinder photography, live view, and movie recording.

---

## ✔ Grayed-Out Items

Some items and menu options may be unavailable depending on camera status. Unavailable items are displayed in gray and cannot be selected.



---

## ✎ The Command Dials

- The main command dial can be used to choose the setting for the item currently highlighted in the **i** menu. Options for the selected setting, if any, can be selected by rotating the sub-command dial.
- Some items can be adjusted by rotating either dial.
- Press **OK** to save changes. You can also save changes by pressing the shutter-release button halfway or highlighting another item.

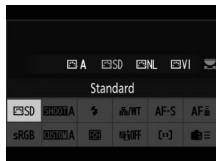

## The Still Photography *i* Menu

Pressing the *i* button during still photography displays the items listed below. Highlight the desired item using the multi-selector and press  $\odot$  to view options.

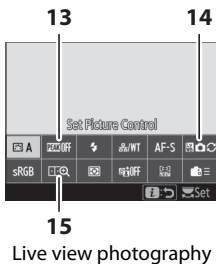
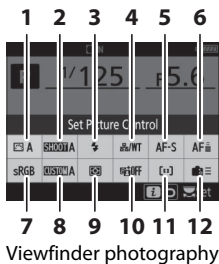

- |   |  |
|---|--|
| 1 | Set Picture Control                      |
| 2 | Photo shooting menu bank <sup>1</sup>    |
| 3 | Flash mode                               |
| 4 | Wired LAN/WT                             |
| 5 | Autofocus mode                           |
| 6 | Focus tracking with lock-on <sup>1</sup> |
| 7 | Color space                              |
| 8 | Select custom settings bank <sup>1</sup> |



- |    |   |
|----|---|
| 9  | Metering                                |
| 10 | Active D-Lighting                       |
| 11 | AF-area mode                            |
| 12 | Custom controls                         |
| 13 | Peaking highlights <sup>2</sup>         |
| 14 | Photo live view display WB <sup>2</sup> |
| 15 | Split-screen display zoom <sup>2</sup>  |

- 1 Displayed during viewfinder photography only.
- 2 Displayed during live view photography only.



---

## Customizing the *i* Menu

Choose the items displayed in the *i* menus. Use Custom Settings f1 [**Customize  menu**] and f2 [**Customize  menu (Lv)**] to choose the items displayed in viewfinder and live photography, respectively.

---

## The Movie *i* Menu

Pressing the *i* button during movie recording displays the items listed below. Highlight the desired item using the multi-selector and press  $\odot$  to view options.

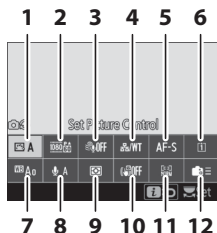

- |   |                                   |    |                        |
|---|-----------------------------------|----|------------------------|
| 1 | Set Picture Control               | 7  | White balance          |
| 2 | Frame size and rate/image quality | 8  | Microphone sensitivity |
| 3 | Wind noise reduction              | 9  | Metering               |
| 4 | Wired LAN/WT                      | 10 | Electronic VR          |
| 5 | Autofocus mode                    | 11 | AF-area mode           |
| 6 | Destination                       | 12 | Custom controls        |

---

### Customize the *i* Menu

Use Custom Setting g1 [**Customize *i* menu**] to choose the items displayed in the movie *i* menu.

---

## The Playback *i* Menu

Pressing the *i* button during playback displays a context-sensitive *i* menu of frequently-used playback options.

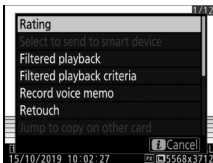
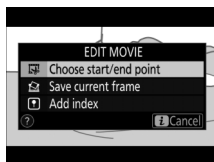

Photo playback



Movie playback



Movie playback paused

## The **Info** Button

Use the **Info** button to view shooting information or choose the indicators displayed.

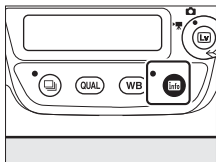

### Viewfinder Photography

During viewfinder photography, you can press the **Info** button to view an information display in the monitor. The display lists such data as shutter speed, aperture, number of exposures remaining, and AF-area mode.

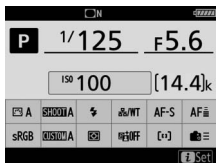

## Live View Photography

Use the **info** button to cycle through the following displays:

### ■ Live View Selector Rotated to

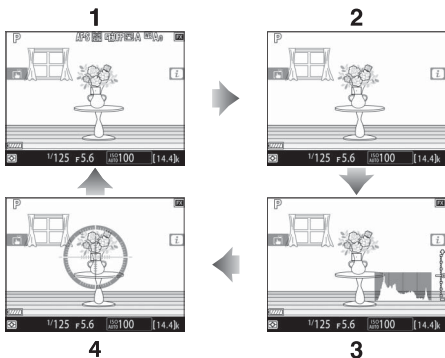

- 1 Indicators on
- 2 Simplified display
- 3 Histogram \*
- 4 Virtual horizon

\* Displayed during exposure preview only.

## Live View Selector Rotated to 90°

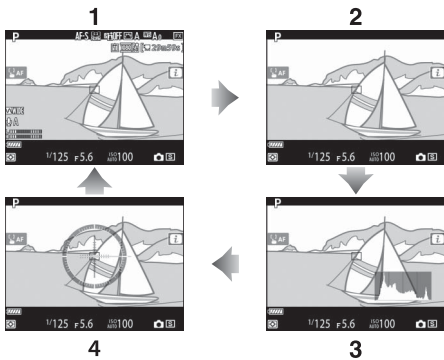

- 1 Indicators on
- 2 Simplified display
- 3 Histogram
- 4 Virtual horizon

## The Focus-Mode Selector

Choose **AF** for autofocus, **M** for manual focus.

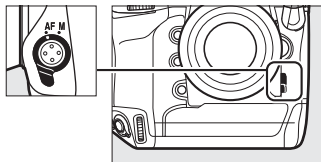

## The AF-Mode Button

Choose the AF and AF-area modes. The AF mode determines how the camera focuses in autofocus mode, the AF-area mode how the camera selects the focus point for autofocus.

### Choosing an AF Mode

Hold the AF-mode button and rotate the main command dial. The options available vary with camera settings.

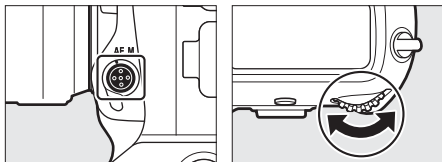



## ■ Viewfinder Photography

During viewfinder photography, the selected AF mode is displayed in the top control panel and viewfinder.



Option		Description
<b>AF-S</b>	[Single AF]	Use with stationary subjects. Focus locks while the shutter-release button is pressed halfway.
<b>AF-C</b>	[Continuous AF]	For moving subjects. The camera adjusts focus continuously in response to changes in the distance to the subject while the shutter-release button is pressed halfway.

## ■ Live View Photography and Filming

During live view photography and filming, the selected AF mode is displayed in the monitor.

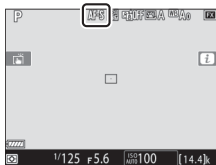

Option		Description
<b>AF-S</b>	<b>[Single AF]</b>	Use with stationary subjects. Focus locks while the shutter-release button is pressed halfway.
<b>AF-F</b>	<b>[Full-time AF]</b>	For moving subjects. The camera adjusts focus continuously in response to changes in the distance to the subject until the shutter-release button is pressed halfway. Focus locks while the shutter-release button is pressed halfway.

## **Choosing an AF-Area Mode**

Hold the AF-mode button and rotate the sub-command dial.  
The options available vary with the AF mode.

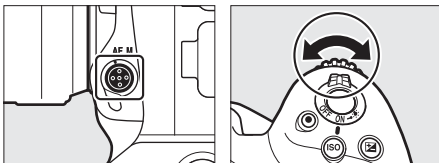

## ■ Viewfinder Photography

The selected AF-area mode is displayed in the top control panel and viewfinder during viewfinder photography.

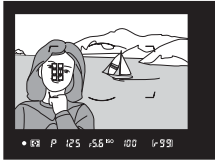

Option	Description
[Single-point AF]	The camera focuses on a point selected by the user. <ul style="list-style-type: none"><li>• Use with stationary subjects.</li></ul>
[Dynamic-area AF (9 points)]/ [Dynamic-area AF (25 points)]/ [Dynamic-area AF (49 points)]/ [Dynamic-area AF (105 points)]	The camera focuses on a point selected by the user; if the subject briefly leaves the selected point, the camera will focus based on information from surrounding focus points. Dynamic-area AF is available when <b>AF-C</b> is selected for autofocus mode. <ul style="list-style-type: none"><li>• Choose for subjects that move unpredictably. The greater the number of focus points, the wider the area used for focus.</li></ul>
[3D-tracking]	The user selects the focus point; while the shutter-release button is pressed halfway, the camera will track subjects that leave the selected focus point and select new focus points as required. 3D-tracking is available when <b>AF-C</b> is selected for autofocus mode. <ul style="list-style-type: none"><li>• Use for subjects that are moving erratically from side to side.</li></ul>

Option	Description
<p>[Group-area AF]/ [Group-area AF (C1)]/[Group-area AF (C2)]</p>	<p>The camera focuses using a group of focus points selected by the user.</p> <ul style="list-style-type: none"> <li>• Choose for snapshots, subjects that are in motion, and other subjects that are difficult to photograph using [Single-point AF].</li> <li>• Use [Group-area AF (C1)] and [Group-area AF (C2)] to create custom groups in which the number of focus points in each dimension can be chosen using the multi selector. This can be used, for example, if the size and shape of the area used for focus can be determined in advance with a fair degree of accuracy.</li> </ul>
<p>[Auto-area AF]</p>	<p>The camera automatically detects the subject and selects the focus point. If a face is detected, the camera will give priority to the portrait subject.</p> 

---

## Custom Focus Groups: [Group-Area AF (C1)]/[Group-Area AF (C2)]

- When [Group-area AF (C1)] or [Group-area AF (C2)] is highlighted, you can adjust the width of the custom focus group by holding the AF-mode button and pressing or . Press or to choose the height. The height and width are shown in the top control panel.

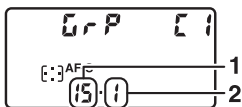

- |   |                                 |
|---|---------------------------------|
| 1 | Width (number of focus points)  |
| 2 | Height (number of focus points) |

- If you keep your eye to the viewfinder while choosing the number of focus points, you can preview the shape of the selected custom focus group.

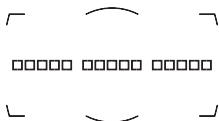





- The number of focus points can also be selected using Custom Setting a10 [Custom groupings (C1/C2)].
-

## ■ Live View Photography/Movie Recording

The selected AF-area mode is displayed in the monitor during live view photography and filming.



Option	Description
 <b>[Face-priority AF]</b>	The camera automatically detects and focuses on portrait subjects; the selected subject is indicated by a yellow border. If multiple faces (up to a maximum of 16) are detected, you can choose a subject using the multi selector. <ul style="list-style-type: none"><li>• Use for portraits.</li></ul>
 <b>[Wide-area AF]</b>	As for <b>[Normal-area AF]</b> except that the camera focuses on a wider area.
 <b>[Normal-area AF]</b>	The camera focuses on a point selected by the user.
 <b>[Subject-tracking AF]</b>	Position the focus point over your subject and press the center of the multi selector; the focus point will track the selected subject as it moves through the frame. To end tracking, press the center of the multi selector again. <ul style="list-style-type: none"><li>• Use to track focus on a chosen subject.</li></ul>

## Manual Focus-Point Selection

When an option other than [Auto-area AF], [Face-priority AF], or [Subject-tracking AF] is selected for AF-area mode, you can select the focus point manually. Press the multi selector up, down, left, or right (⬆️⬇️⬅️➡️) or diagonally to select the focus point.

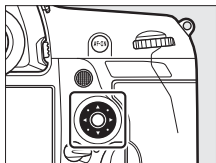

## Locking Focus-Point Selection

Focus-point selection can be locked by rotating the focus selector lock to the "L" position. Focus-point selection can be re-enabled by rotating the lock to ●.

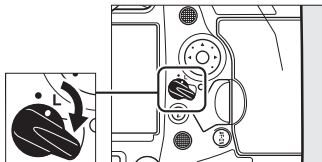



## The AF-ON Button

The **AF-ON** button can be used for focus in autofocus mode.

- You can choose the role assigned to the **AF-ON** button. Use Custom Settings f3 [**Custom controls**] and g2 [**Custom controls**] in the Custom Settings menu to choose the roles played by the button during photography and movie recording, respectively.

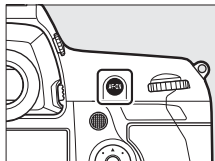

---

### ▣ The AF-ON Button for Vertical Shooting

The **AF-ON** button performs the same function, but can only be used when the vertical shooting shutter-release button lock is unlocked.

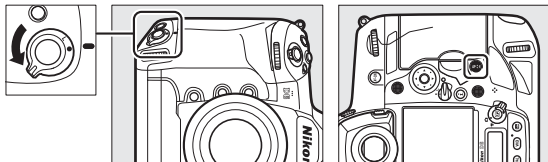

# The MODE Button

Choose an exposure mode.

## Choosing an Exposure Mode

Hold the **MODE** button and rotate the main command dial.

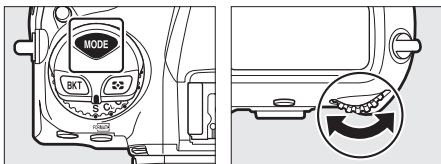

Mode		Description
<b>P</b>	<b>Programmed auto</b>	The camera sets shutter speed and aperture for optimal exposure.
<b>S</b>	<b>Shutter-priority auto</b>	You choose the shutter speed; the camera selects the aperture for best results.
<b>A</b>	<b>Aperture-priority auto</b>	You choose the aperture; the camera selects the shutter speed for best results.
<b>M</b>	<b>Manual</b>	You control both shutter speed and aperture. Set shutter speed to "bulb" or "time" for long time-exposures.

## The Release Mode Dial and Button



Rotate the release mode dial to choose the operation performed when the shutter is released.

### Choosing a Release Mode

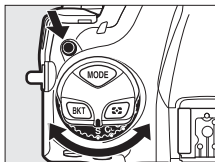
Press the release mode dial lock release on top of the camera and rotate the release mode dial.



Mode		Description
<b>S</b>	<b>Single frame</b>	The camera takes one photograph each time the shutter-release button is pressed.
<b>CL</b>	<b>Continuous low speed</b>	The camera takes photos at a selected rate while the shutter-release button is pressed. The frame rate can be selected from values between 1 and 10 fps.
<b>CH</b>	<b>Continuous high speed</b>	The camera takes photos at a selected rate while the shutter-release button is pressed. The frame rate can be selected from values between 10 and 14 fps.

Mode		Description
Q	<b>Quiet shutter release</b>	Take pictures more quietly than in single-frame mode. Burst shooting at rates of 1 to 5 fps is also supported.
	<b>Self-timer</b>	Take pictures with the self-timer.
MUP	<b>Mirror up</b>	The mirror is raised before shooting to minimize blur caused by camera shake.
	<b>Quick release-mode selection</b>	The release mode can be selected by holding the  button and rotating the main command dial.



## The Button

Use the  button to choose how the camera meters light when setting exposure.

### Choosing a Metering Option

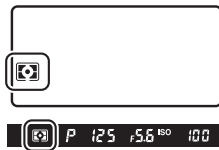
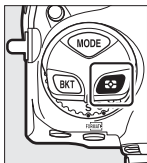
Hold the  button and rotate the main command dial.



Option	Description
 <b>[Matrix metering]</b>	Matrix metering is adapted to a wide range of subjects. It produces natural-looking results.
 <b>[Center-weighted metering]</b>	The camera assigns the greatest weight to the center of the frame. It can be used with subjects that dominate the composition, for example.

Option	Description
□	<b>[Spot metering]</b> The camera meters a circle 4 mm (0.16 in.) in diameter (approximately 1.5% of frame). Use for example to meter a specific area of the frame when your subject is backlit or features sharply contrasting areas.
□*	<b>[Highlight-weighted metering]</b> The camera assigns the greatest weight to highlights. Use this option to reduce loss of detail in highlights, for example when photographing spotlit performers on stage.

## The BKT Button

Use the **BKT** button to choose the bracketing increment and number of shots in the bracketing program. Bracketing is used to vary exposure, flash level, white balance, or Active D-Lighting (ADL) over a series of shots.

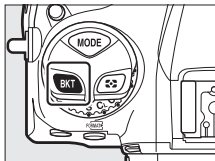

- The role performed by the **BKT** button can be chosen using Custom Setting f3 [**Custom controls**].

## The ISO (FORMAT) Button

Use the ISO (FORMAT) button to adjust the camera's sensitivity to light (ISO sensitivity). The higher the ISO sensitivity, the less light needed to make an exposure, allowing faster shutter speeds or smaller apertures. You also have the option of enabling auto ISO sensitivity control, which automatically adjusts sensitivity if optimal exposure cannot be achieved at the setting selected by the user.

### **Adjusting ISO Sensitivity**

Hold the ISO (FORMAT) button and rotate the main command dial.

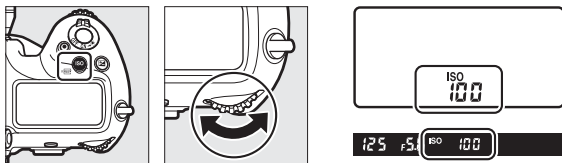

Choose from values of from ISO 100 to 102400. Settings of from about 0.3 to 1 EV below ISO 100 and 0.3 to 5 EV above ISO 102400 are also available.



---

## ✔ High ISO Sensitivities

The higher the ISO sensitivity, the less light needed to make an exposure, allowing pictures to be taken when lighting is poor and helping prevent blur when the subject is in motion. Note, however, that the higher the sensitivity, the more likely the image is to be affected by “noise” in the form of randomly-spaced bright pixels, fog, or lines.

---



## Enabling Auto ISO Sensitivity Control

Hold the **ISO** (FORMAT) button and rotate the sub-command dial to choose whether the camera will automatically adjust ISO sensitivity if the desired exposure cannot be achieved at the value selected by the user.

- When auto ISO sensitivity control is enabled, **ISO AUTO** indicators will appear in the top control panel and viewfinder. When these indicators are lit (not flashing), pictures will be taken at the sensitivity selected for **[ISO sensitivity]**. When sensitivity is altered from the value selected by the user, the **ISO AUTO** indicators will flash and the altered value will be shown in the displays.

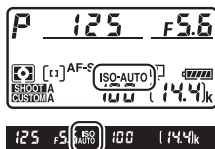
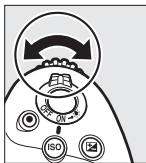
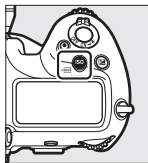

---

### **Maximum Sensitivity**

You can select an upper limit for auto ISO sensitivity control to prevent ISO sensitivity being raised too high. The maximum ISO sensitivity can be selected using the **[ISO sensitivity settings] > [Auto ISO sensitivity control] > [Maximum sensitivity]** item in the photo shooting menu.

---

## The Button

Use the  (exposure compensation) button to alter exposure from the value suggested by the camera. Exposure compensation can be used to make pictures brighter or darker.



-1 EV

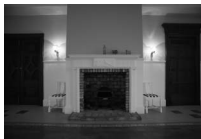

No exposure  
compensation



+1 EV

## Adjusting Exposure Compensation

Hold the  button and rotate the main command dial.

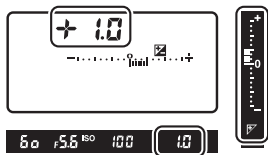
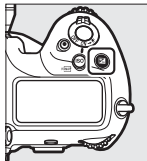

- Higher values make the subject brighter, lower values darker.
- Normal exposure can be restored by setting exposure compensation to  $\pm 0.0$ . Exposure compensation is not reset when the camera is turned off.

## The QUAL Button

The **QUAL** button is used to adjust image quality and choose the size of JPEG images.

### Adjusting Image Quality

Hold the **QUAL** button and rotate the main command dial.

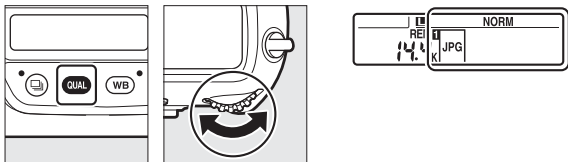

Option	Description
[NEF (RAW) + JPEG fine★]	Record two copies of each photo: an NEF (RAW) image and a JPEG copy. For the JPEG copy, you can choose from options prioritizing image quality or file size. Options with a star ("★") prioritize image quality, those without a star ("★") file size.
[NEF (RAW) + JPEG fine]	
[NEF (RAW) + JPEG normal★]	
[NEF (RAW) + JPEG normal]	
[NEF (RAW) + JPEG basic★]	
[NEF (RAW) + JPEG basic]	
[NEF (RAW)]	Record photos in NEF (RAW) format.

Option	Description
[JPEG fine★]	Record photos in JPEG format. Image quality increases as quality progress from basic through normal to fine. Options with a star ("★") prioritize image quality, those without a star ("★") file size.
[JPEG fine]	
[JPEG normal★]	
[JPEG normal]	
[JPEG basic★]	
[JPEG basic]	

### Dual-Format Recording

- If you select [RAW Slot 1 - JPEG Slot 2] for [Role played by card in Slot 2] in the photo shooting menu when taking pictures with a NEF (RAW) + JPEG option selected for image quality, the NEF (RAW) copies will be recorded to the card in Slot 1 and the JPEG copies to the card in Slot 2.
- If a JPEG option is selected for image quality and [JPEG Slot 1 - JPEG Slot 2] is selected for [Role played by card in Slot 2], the camera will record two copies of each picture, one to each memory card and each at different sizes.

## Choosing an Image Size

Hold the **QUAL** button and rotate the sub-command dial.

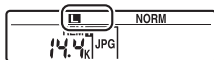
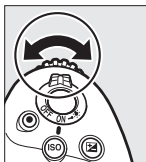
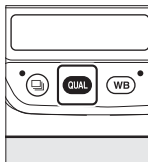

- Choose from [**Large**], [**Medium**], and [**Small**]; the selected option applies to JPEG photos. The physical dimensions of the photos in pixels varies with image area.

Image area	Image size		
	[Large]	[Medium]	[Small]
[FX (36×24)]	5568×3712	4176×2784	2784×1856
[1.2× (30×20)]	4640×3088	3472×2312	2320×1544
[DX (24×16)]	3648×2432	2736×1824	1824×1216
[5:4 (30×24)]	4640×3712	3472×2784	2320×1856
[1:1 (24×24)]	3712×3712	2784×2784	1856×1856
[16:9 (36×20)]	5568×3128	4176×2344	2784×1560

- The size of NEF (RAW) images can be selected using the [**Image size**] > [**NEF (RAW)**] item in the photo shooting menu.

## The WB Button

The **WB** button can be used to adjust white balance. White balance delivers natural colors with light sources of different hues.

### Adjusting White Balance

Hold the **WB** button and rotate the main command dial.

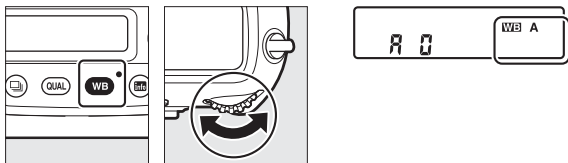

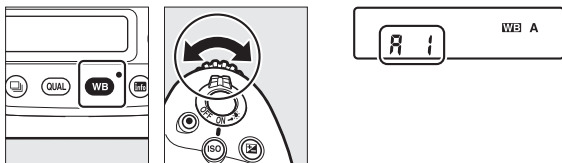

Options for the selected setting, if any, can be selected by holding the **WB** button and rotating the sub-command dial.



Option	Description
AUTO [Auto]	White balance is adjusted automatically for optimal results with most light sources.
AUTO0 [Keep white (reduce warm colors)]	Eliminate the warm color cast produced by incandescent lighting.
AUTO1 [Keep overall atmosphere]	Partially preserve the warm color cast produced by incandescent lighting.
AUTO2 [Keep warm lighting colors]	Preserve the warm color cast produced by incandescent lighting.
☀️ A [Natural light auto]	When used under natural light in place of [Auto], this option produces colors closer to those seen by the naked eye.
☀️ [Direct sunlight]	Use with subjects lit by direct sunlight.
☁️ [Cloudy]	Use in daylight under overcast skies.
🏠 [Shade]	Use in daylight with subjects in shade.
💡 [Incandescent]	Use under incandescent lighting.



Option	Description
 <b>[Fluorescent]</b> <b>[Sodium-vapor lamps]</b> <b>[Warm-white fluorescent]</b> <b>[White fluorescent]</b> <b>[Cool-white fluorescent]</b> <b>[Day white fluorescent]</b> <b>[Daylight fluorescent]</b> <b>[High temp. mercury-vapor]</b>	Use under fluorescent lighting; choose the bulb type according to the light source.
 <b>[Flash]</b>	Use for flash photography.
 <b>[Choose color temperature]</b>	Choose the color temperature directly.
<b>PRE [Preset manual]</b>	Measure white balance for the subject or light source or copy white balance from an existing photograph.



## ▣ Fine-Tuning White Balance

To fine-tune white balance, use the multi selector while holding the **WB** button.

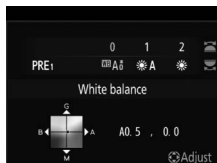
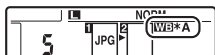



- When an option other than [**Choose color temperature**] or [**Preset manual**] is selected, you can fine-tune white balance on the amber-blue axis by pressing or and on the green-magenta axis by pressing or .
- When [**Choose color temperature**] is selected, you can press or to highlight a digit. Press or to change.
- Release the **WB** button to return to shooting mode.
- At settings other than 0, an asterisk ("**\***") appears in the rear control panel.
- To view the current value, press the **WB** button while shooting information is displayed.









## The (/?) Button

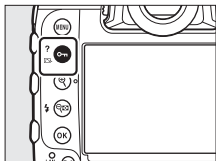



Use the  (/?) button to choose image processing (“Picture Control”) options for new photos according to the scene or your creative intent.

### Choosing a Picture Control

Pressing the  (/?) button displays Picture Control options. Highlight an option using  or  and press  to select.









Option		Description
 A	<b>[Auto]</b>	The camera automatically adjusts hues and tones based on the <b>[Standard]</b> Picture Control.
 SD	<b>[Standard]</b>	Standard processing for balanced results. Recommended for most situations.
 NL	<b>[Neutral]</b>	Minimal processing for natural results. Choose for photographs that will later be processed or retouched.
 VI	<b>[Vivid]</b>	Pictures are enhanced for a vivid, photoprint effect. Choose for photographs that emphasize primary colors.
 MC	<b>[Monochrome]</b>	Take monochrome photographs.

Option		Description
 PT	[Portrait]	Smooth complexions for natural-looking portraits.
 LS	[Landscape]	Shoot vibrant landscapes and cityscapes.
 FL	[Flat]	Details are preserved over a wide tone range, from highlights to shadows. Choose for photographs that will later be extensively processed or retouched.
 01 -  20	<b>Creative Picture Control</b>	Creative Picture Controls offer unique combinations of hue, tone, saturation, and other settings tuned for particular effects. Choose from a total of 20 options, including [Dream] and [Morning].

## ■ ■ Modifying Picture Controls

To modify Picture Control settings, highlight a Picture Control and press .

- Press  or  to highlight settings. Press  or  to choose a value in increments of 1, or rotate the sub-command dial to choose a value in increments of 0.25.
- The options available vary with the Picture Control selected.
- Default settings can be restored by pressing the  (FORMAT) button.
- Press  to save changes.
- Picture Controls that have been modified from default settings are indicated by an asterisk ("\*").

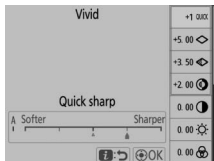

## Picture Control Settings

Option	Description
[Effect level]	Mute or heighten the effect of Creative Picture Controls.
[Quick sharp]	Quickly adjust levels for balanced [Sharpening], [Mid-range sharpening], and [Clarity]. These parameters can also be adjusted individually.
[Sharpening]	Control the sharpness of details and outlines.
[Mid-range sharpening]	Adjust the sharpness of patterns and lines in the range between [Sharpening] and [Clarity].
[Clarity]	Adjust overall sharpness and the sharpness of thicker outlines without affecting brightness or dynamic range.
[Contrast]	Adjust contrast.
[Brightness]	Raise or lower brightness without loss of detail in highlights or shadows.
[Saturation]	Control the vividness of colors.
[Hue]	Adjust hue.
[Filter effects]	Simulate the effect of color filters on monochrome pictures.
[Toning]	Choose the tint used in monochrome pictures. Pressing  when an option other than [B&W] (black-and-white) is selected displays saturation options.
[Toning] (Creative Picture Control)	Choose the shade of color used for Creative Picture Controls.

## ✓ The $\Delta$ Indicator

The  $\Delta$  indicator under the value display in the Picture Control setting menu indicates the previous value for the setting.



## ✓ [A] (Auto)

- Selecting the [A] (auto) option available for some settings lets the camera adjust the setting automatically.
- Results vary with exposure and the position of the subject in the frame.

## ✓ [Filter Effects]

Choose from the following [Filter effects]:

Option	Description
[Y] (yellow) *	These options enhance contrast and can be used to tone down the brightness of the sky in landscape photographs. Orange [O] produces more contrast than yellow [Y], red [R] more contrast than orange.
[O] (orange) *	
[R] (red) *	
[G] (green) *	Green softens skin tones. Use for portraits and the like.

\* The term in parentheses is the name of the corresponding third-party color filter for black-and-white photography.

---

## 🔍 The [Auto] Picture Control

Settings can be adjusted in the range [A-2] to [A+2].

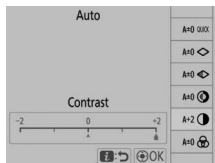

## 🔍 Protecting Pictures from Deletion

During playback, the (🔒/?/?) button can be used to protect pictures. Protecting pictures helps prevent accidental deletion.

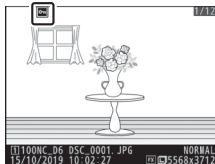



## 🔍 Viewing Help

Press the (🔒/?/?) button to view help for the current item, where available (📖 87).



---







## The () Button

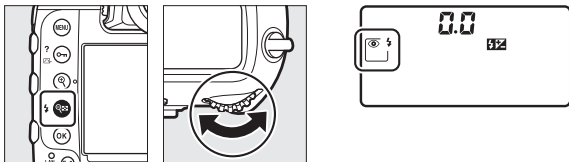

During shooting, the  () button can be used to choose the flash mode and adjust flash compensation for optional flash units. Flash mode determines the effect produced by the flash, flash compensation the flash level.

### Choosing a Flash Mode

Hold the  () button and rotate the main command dial.



	Option	Description
	<b>[Fill flash]</b> (front-curtain sync)	This mode is recommended for most situations.
	<b>[Red-eye reduction]</b> (red-eye reduction)	The flash fires before the photograph is taken, reducing "red-eye".
	<b>[Slow sync]</b> (slow sync)	As for "fill flash", except that slow shutter speeds are used to capture background lighting at night or under low light.

	Option	Description
	<b>[Slow sync + red-eye]</b> (red-eye reduction with slow sync)	As for “red-eye reduction”, except that slow shutter speeds are used to capture background lighting at night or under low light.
	<b>[Rear-curtain sync]</b> (rear-curtain sync)	The flash fires just before the shutter closes.
	<b>[Flash off]</b>	The flash does not fire.

## Adjusting Flash Compensation

Hold the  button and rotate the sub-command dial.

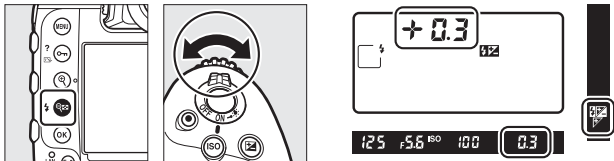

- Choose positive values for brighter lighting, negative values to ensure that the subject is not too brightly lit.
- Normal flash output can be restored by setting flash compensation to  $\pm 0.0$ . Flash compensation is not reset when the camera is turned off.

## The Pv Button

Pressing the **Pv** button during viewfinder photography stops lens aperture down to the current value, allowing depth of field to be previewed as long as the button is kept pressed.

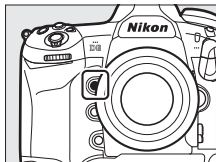

- Optional flash units compatible with the Nikon Creative Lighting System (CLS) will emit a modeling flash. The modeling flash can be disabled by selecting [**Off**] for Custom Setting e6 [**Modeling flash**].
- You can choose the role assigned to the **Pv** button. Use Custom Settings f3 [**Custom controls**] and g2 [**Custom controls**] in the Custom Settings menu to choose the roles played by the button during photography and filming, respectively.

## The Fn1, Fn2, Fn3 (☺), and Fn (Vertical) Buttons

Use the **Fn1**, **Fn2**, **Fn3** (☺), or vertical **Fn** button for quick access to selected settings.

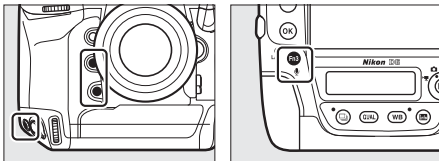

- The assigned setting can be adjusted by holding the corresponding button and rotating the command dials. In some cases, adjustments can be made using both the main and sub-command dials.
- Use Custom Settings f3 [**Custom controls**] and g2 [**Custom controls**] in the Custom Settings menu to choose the roles played by these buttons during photography and movie recording, respectively.

# Troubleshooting

## Before Contacting Customer Support

You may be able to resolve any issues with the camera by following the steps below. Check this list before consulting your retailer or Nikon-authorized service representative.

---

**STEP 1** Check the common problems listed in the following sections:

- “Problems and Solutions” (□ 138)
  - “Alerts and Error Messages” (□ 150)
- 

**STEP 2** Turn the camera off and remove the battery, then wait about a minute, re-insert the battery and turn the camera on.

- ☑ The camera may continue to write data to the memory card after shooting. Wait at least a minute before removing the battery.
- 

**STEP 3** Search Nikon websites.

- For support information and answers to frequently asked questions, visit the website for your country or region (□ xxix).
  - To download the latest firmware for your camera, visit: <https://downloadcenter.nikonimglib.com/>
- 

**STEP 4** Consult a Nikon-authorized service representative.

---

---

## ✔ Restoring Default Settings

- Depending on current settings, some menu items and other features may be unavailable. To access menu items that are grayed out or features that are otherwise unavailable, try restoring default settings using the **[Reset all settings]** item in the setup menu.
  - Note, however, that wireless network profiles, copyright information, and other user-generated entries will also be reset. Once reset, settings cannot be restored.
-

# Problems and Solutions

Solutions to some common issues are listed below.

## **Battery/Display**

---

### ● **The camera is on but does not respond:**

- Wait for recording and other operations to end.
  - If the problem persists, turn the camera off.
  - If the camera does not turn off, remove and reinsert the battery.
  - If you are using an AC adapter, disconnect and reconnect the AC adapter.
    - Any data currently being recorded will be lost.
    - Data that have already been recorded are not affected by removing or disconnecting the power source.
- 

### ● **The viewfinder is out of focus:**

- Rotate the diopter adjustment control to adjust viewfinder focus.
  - If adjusting viewfinder focus does not correct the problem, set the autofocus mode to **AF-S** and the AF-area mode to [**Single-point AF**]. Next, select the center focus point, choose a high-contrast subject, and focus using autofocus. With the camera in focus, use the diopter adjustment control to bring the subject into clear focus in the viewfinder.
  - If necessary, viewfinder focus can be further adjusted using optional corrective lenses.
-



---

● **The viewfinder is dark:**

Is the battery charged? The viewfinder may dim if the battery is exhausted or not inserted (📖 28, 47).

---

● **The display in the viewfinder, control panel, or monitor turns off without warning:**

Choose longer delays for Custom Setting c2 [**Standby timer**] or c4 [**Monitor off delay**].

---

● **The display in control panel or viewfinder is dim and unresponsive:**

The response times and brightness of these displays vary with temperature.

---

● **Patterns appear in the viewfinder:**

The viewfinder display may turn red when a focus point is highlighted, but this is normal for this type of viewfinder and does not indicate a malfunction.

---

## Shooting

---

● **The camera takes time to turn on:**

More time will be needed to find files if the memory card contains large numbers of files or folders.

---

● **The shutter cannot be released:**

- Is a memory card inserted, and if so, does it have space available?
  - When a CPU lens of a type other than G or E is attached, the shutter cannot be released unless the aperture ring is locked at minimum aperture (the highest f-number). If **fE E** is displayed in the top control panel, select [**Aperture ring**] for Custom Setting f6 [**Customize command dials**] > [**Aperture setting**] and adjust aperture using the lens aperture ring.
  - If you selected mode **S** after selecting a shutter speed of **b** **w** **L** **b** (Bulb) or - - (Time) in mode **M**, choose a different shutter speed.
  - Is [**Release locked**] selected for [**Slot empty release lock**] in the setup menu?
- 

● **The camera is slow to respond to the shutter-release button:**

Select [**Off**] for Custom Setting d5 [**Exposure delay mode**].

---

● **Burst shooting is unavailable:**

Burst shooting cannot be used in conjunction with HDR.

---

---

● **Photos are out of focus:**

- Is the camera in manual focus mode? To enable autofocus, rotate the focus-mode selector to **AF**.
- Autofocus does not perform well under the following conditions. In these cases, use manual focus or focus lock. Autofocus does not perform well if: there is little or no contrast between the subject and the background, the focus point contains objects at different distances from the camera, the subject is dominated by regular geometric patterns, the focus point contains areas of sharply contrasting brightness, background objects appear larger than the subject, or the subject contains many fine details.

---

● **The beep does not sound:**

- A beep does not sound when the camera focuses with **AF-C** selected for autofocus mode.
- Select an option other than **[Off]** for **[Beep options]** > **[Beep on/off]** in the setup menu.

---

● **The full range of shutter speeds is not available:**

Using a flash restricts the range of shutter speeds available. Flash sync speed can be set to values of  $1/250$ – $1/60$  s using Custom Setting e1 **[Flash sync speed]**. When using flash units that support auto FP high-speed sync, choose **[1/250 s (Auto FP)]** for a full range of shutter speeds.

---

---

● **Focus does not lock when the shutter-release button is pressed halfway:**

If **AF-C** is selected for autofocus mode, focus can be locked by pressing the center of the sub-selector.

---

● **Focus-point selection is not available:**

- Is the focus selector lock in the **L** (lock) position?
  - Focus-point selection is not available when [**Auto-area AF**] is selected for AF-area mode.
  - Focus point selection is not available in playback mode or when menus are in use.
  - Has the standby timer expired? To enable focus-point selection, press the shutter-release button halfway.
- 

● **AF mode selection is not available:**

Select [**No restrictions**] for Custom Setting a15 [**Autofocus mode restrictions**].

---

● **The camera is slow to record photos:**

Is [**On**] selected for [**Long exposure NR**] in the photo shooting menu?

---

---

● **“Noise” (bright spots, randomly-spaced bright pixels, fog, or lines) appears in photos:**

- To reduce noise, adjust settings such as ISO sensitivity, shutter speed, or Active D-Lighting.
  - At high ISO sensitivities, noise may become more noticeable in long exposures or in pictures recorded when the camera temperature is elevated.
-

---

● **Photographs and movies do not appear to have the same exposure as the preview shown in the monitor during live view:**

Changes to monitor brightness during live view have no effect on images recorded with the camera.

---

● **Flicker or banding appears in the display during movie recording:**

Select [**Flicker reduction**] in the movie shooting menu and choose an option that matches the frequency of the local AC power supply.

---

● **Bright regions or bands appear in live view:**

Bright regions or bands may occur if a flashing sign, flash, or other light source with brief duration is used during live view.

---

● **Smudges appear in photographs:**

- Are there smudges on the front or rear (mount-side) lens elements?
- Is there foreign matter on the low-pass filter? Perform image sensor cleaning.

---

● **Live view ends unexpectedly or does not start:**

- Live view may end automatically to prevent damage to the camera's internal circuits, for example if:
    - The ambient temperature is high
    - The camera has been used for extended periods in live view or to record movies
    - The camera has been used in continuous release modes for extended periods
  - If the camera is running hot and live view does not start, wait for the internal circuits to cool and then try again. Note that the camera may feel warm to the touch, but this does not indicate a malfunction.
-

---

● **“Noise” (bright spots, randomly-spaced bright pixels, fog, or lines) appears during live view:**

- Randomly-spaced bright pixels, fog, or bright spots may arise as a result of increases in the temperature of the camera’s internal circuits during live view. Exit live view when the camera is not in use.
- Randomly-spaced bright pixels, fog, lines or unexpected colors may appear if you press the  button to zoom in on the view through the lens during live view.
- In movies, the amount and distribution of randomly-spaced bright pixels, fog, and bright spots are affected by the option selected for **[Frame size/frame rate]** in the movie shooting menu.
- Note that the distribution of noise in the monitor may differ from that in the final picture.

---

● **Monitor hue changes sharply during live view:**

Monitor hue may change sharply at high sensitivities (Hi 0.3 to Hi 5) during burst photography or immediately after the shutter is released; this does not indicate a malfunction. The display will shortly return to normal. Pictures taken with the camera are unaffected.

---

● **The camera cannot measure a value for preset manual white balance:**

The subject is too dark or too bright.

---

● **Certain pictures cannot be selected as sources for preset white balance:**

Pictures created with cameras of other types cannot serve as sources for preset manual white balance.

---

---

● **White balance (WB) bracketing is unavailable:**

- White balance bracketing is not available when an NEF (RAW) or NEF + JPEG option is selected for image quality.
- White balance bracketing cannot be used in multiple exposure and HDR modes.

---

● **The effects of [Set Picture Control] differ from image to image:**

[Auto] is selected for [Set Picture Control] or as the basis for a custom Picture Control created using [Manage Picture Control], or [A] (auto) is selected for [Quick sharp], [Contrast], or [Saturation]. For consistent results over a series of photographs, choose a setting other than [A] (auto).

---

● **The option selected for metering cannot be changed:**

The option selected for metering cannot be changed during exposure lock.

---

● **Exposure compensation is not available:**

Changes to exposure compensation in mode **M** apply only to the exposure indicator and have no effect on shutter speed or aperture.

---

● **Uneven shading may appear in long exposures:**

Uneven shading may appear in long exposures shot at shutter speeds of **b** **u** **t** **b** (Bulb) or - - (Time). The effect can be mitigated by selecting [On] for [Long exposure NR] in the photo shooting menu.

---

● **Sound is not recorded with movies:**

Is [Microphone off] selected for [Microphone sensitivity] in the movie shooting menu?

---



## **Playback**

---

● **NEF (RAW) pictures are not visible during playback:**

The camera displays only the JPEG copies of pictures taken with [NEF (RAW) + JPEG fine★], [NEF (RAW) + JPEG fine], [NEF (RAW) + JPEG normal★], [NEF (RAW) + JPEG normal], [NEF (RAW) + JPEG basic★], or [NEF (RAW) + JPEG basic] selected for [Image quality].

---

● **Pictures taken with other cameras are not displayed:**

Pictures recorded with other types of camera may not display correctly.

---

● **Not all photos are visible during playback:**

Select [All] for [Playback folder] in the playback menu.

---

● **“Tall” (portrait) orientation photos are displayed in “wide” (landscape) orientation:**

- Is [Off] selected for [Rotate tall] in the playback menu?
  - Auto image rotation is not available during image review.
  - Camera orientation may not be correctly recorded in photos taken with the camera pointing up or down.
- 

● **Pictures cannot be deleted:**

Are the pictures protected?

---

● **Pictures cannot be retouched:**

- The pictures cannot be further edited with this camera.
  - There is insufficient space on the memory card to record the retouched copy.
- 

● **The camera displays the message, [Folder contains no images]:**

Select [All] for [Playback folder] in the playback menu.

---

● **Pictures are not displayed on HDMI devices:**

Confirm that an HDMI cable is correctly connected.

---

---

● **The Image Dust Off option in NX Studio does not have desired effect:**

Image sensor cleaning changes the position of dust on the low-pass filter and will not have the desired effect if:

- Dust off reference data recorded after image sensor cleaning is performed are used with photographs taken before image sensor cleaning is performed
- Dust off reference data recorded before image sensor cleaning is performed are used with photographs taken after image sensor cleaning is performed

---

● **The effects of [Set Picture Control], [Active D-Lighting], or [Vignette control] are not visible:**

In the case of NEF (RAW) pictures, the effects can only be viewed using Nikon software. View NEF (RAW) pictures using NX Studio.

---

● **Pictures cannot be copied to a computer:**

Depending on the operating system, you may be unable to upload pictures when the camera is connected to a computer. Copy pictures from the memory card to a computer using a card reader or other device.

---

## **Bluetooth and Wi-Fi (Wireless Networks)**

---

### ● **Smart devices do not display the camera SSID (network name):**

- Navigate to the setup menu and confirm both that [**Disable**] is selected for [**Airplane mode**] and that [**Enable**] is selected for [**Connect to smart device**] > [**Pairing (Bluetooth)**] > [**Bluetooth connection**].
- Confirm that the [**Connect to smart device**] > [**Wi-Fi connection**] is enabled in the setup menu.
- Try disabling and re-enabling wireless network features on the smart device.

### ● **The camera cannot connect to printers and other wireless devices:**

The camera cannot establish wireless connections with devices other than smartphones, tablets, and computers.

## **Miscellaneous**

---

### ● **The date of recording is not correct:**

Is the camera clock set correctly? The clock is less accurate than most watches and household clocks; check it regularly against more accurate timepieces and reset as necessary.

### ● **Menu items cannot be selected:**



- Some items are not available at certain combinations of settings.
- The [**Battery info**] item in the setup menu is not available when camera is powered by an optional power connector and AC adapter.





## Alerts and Error Messages

This section lists the alerts and error messages that appear in the viewfinder, top control panel, and monitor.

### Alerts

The following alerts appear in the top control panel and viewfinder:

Alert		Problem/solution
Top control panel	Viewfinder	
$fE E$ (flashes)	$fE E$ (flashes)	<b>Lens aperture ring is not set to minimum aperture.</b> Set lens aperture ring to minimum aperture (highest f-number).
		<b>Low battery.</b> Ready spare battery.

Alert		Problem/solution
Top control panel	Viewfinder	
 (flashes)	 (flashes)	<p><b>Battery exhausted.</b></p> <ul style="list-style-type: none"> <li>• Replace with spare battery.</li> <li>• Charge battery.</li> </ul> <hr/> <p><b>Battery info not available.</b></p> <ul style="list-style-type: none"> <li>• Battery cannot be used. Contact Nikon-authorized service representative.</li> <li>• Battery level is extremely low; charge battery.</li> </ul> <hr/> <p><b>Battery cannot supply data to camera.</b>            Replace third-party batteries with genuine Nikon batteries.</p> <hr/> <p><b>High battery temperature.</b>            Remove battery and wait for it to cool.</p>
 (flashes)	—	<p><b>Camera clock is not set.</b>            Set camera clock.</p>
		<p><b>Aperture shown in stops from maximum aperture. No lens attached, or non-CPU lens attached without specifying maximum aperture.</b>            Aperture value will be displayed if maximum aperture is specified.</p>

Alert		Problem/solution
Top control panel	Viewfinder	
—	▶◀ (flashes)	<b>Camera unable to focus using autofocus.</b> Change composition or focus manually.
b u l b (flashes)	b u l b (flashes)	<b>b u l b (Bulb) selected in mode S.</b> <ul style="list-style-type: none"> <li>• Change shutter speed.</li> <li>• Select mode <b>M</b>.</li> </ul>
- - (flashes)	- - (flashes)	<b>- - (Time) selected in mode S.</b> <ul style="list-style-type: none"> <li>• Change shutter speed.</li> <li>• Select mode <b>M</b>.</li> </ul>
b u s y (flashes)	b s y (flashes)	<b>Processing in progress.</b> Wait for processing to complete.
—	⚡ (flashes)	<b>Flash has fired at full power.</b> Photo may be underexposed. Check distance to subject and settings such as aperture, flash range, and ISO sensitivity.

Alert		Problem/solution
Top control panel	Viewfinder	
(Exposure indicators and shutter speed or aperture display flash)		<p><b>Subject too bright; limits of camera exposure metering system exceeded.</b></p> <ul style="list-style-type: none"> <li>• Lower ISO sensitivity.</li> <li>• Mode <b>P</b>: Use third-party ND (neutral density) filter (filter can also be used if alert is still displayed after following settings are adjusted in mode <b>S</b> or <b>A</b>).</li> <li>• Mode <b>S</b>: Choose faster shutter speed.</li> <li>• Mode <b>A</b>: Choose smaller aperture (higher f-number).</li> </ul>
		<p><b>Subject too dark; limits of camera exposure metering system exceeded.</b></p> <ul style="list-style-type: none"> <li>• Increase ISO sensitivity.</li> <li>• Mode <b>P</b>: Use optional flash unit (flash can also be used if alert is still displayed after following settings are adjusted in mode <b>S</b> or <b>A</b>).</li> <li>• Mode <b>S</b>: Choose slower shutter speed.</li> <li>• Mode <b>A</b>: Choose wider aperture (lower f-number).</li> </ul>

Alert		Problem/solution
Top control panel	Viewfinder	
 (flashes)	—	<p><b>Flash unit that does not support red-eye reduction attached and flash mode set to red-eye reduction or red-eye reduction with slow sync.</b></p> <ul style="list-style-type: none"> <li>• Use flash unit that supports red-eye reduction.</li> <li>• Change flash mode.</li> </ul>
<b>F u l l l</b> (flashes)	<b>F u l</b> (flashes)	<p><b>Memory insufficient to record further photos.</b></p> <ul style="list-style-type: none"> <li>• Delete pictures from memory card until there is room for additional pictures to be recorded. Copy pictures you wish to keep to computer or other device before proceeding.</li> <li>• Insert new memory card.</li> </ul> <hr/> <p><b>Camera has run out of file numbers.</b></p> <ul style="list-style-type: none"> <li>• Delete pictures from memory card until there is room for additional pictures to be recorded. Copy pictures you wish to keep to computer or other device before proceeding.</li> <li>• Insert new memory card.</li> </ul>
<b>E r r</b> (flashes)	<b>E r r</b> (flashes)	<p><b>Camera malfunction.</b></p> <p>Press shutter-release button again. If error persists or appears frequently, consult Nikon-authorized service representative.</p>



## Error Messages

The following alerts appear in the monitor and top control panel:

Alert		Problem/solution
Monitor	Top control panel	
No memory card.	[ - E - ]	<b>Memory card not inserted or inserted incorrectly.</b> Check that card is inserted correctly.
Cannot access this memory card. Insert another card.	[ Err ], [ Err ] (flashes)	<b>Error accessing memory card.</b> <ul style="list-style-type: none"><li>• Check that camera supports memory card.</li><li>• If error persists after card has been repeatedly ejected and reinserted, card may be damaged. Contact retailer or Nikon-authorized service representative.</li></ul> <b>Unable to create new folder.</b> <ul style="list-style-type: none"><li>• Delete pictures from memory card until there is room for additional pictures to be recorded. Copy pictures you wish to keep to computer or other device before proceeding.</li><li>• Insert new memory card.</li></ul>

Alert		Problem/solution
Monitor	Top control panel	
This card is not formatted. Format the card.	{ <b>For</b> } (flashes)	<b>Memory card is not correctly formatted.</b> <ul style="list-style-type: none"> <li>• Format memory card.</li> <li>• Replace with correctly-formatted memory card.</li> </ul>
Unable to start live view. Please wait.	—	<b>Camera's internal temperature is elevated.</b> Suspend shooting until camera has cooled.
Folder contains no images.	—	<b>Folder contains no pictures.</b> Insert memory card that contains pictures. <b>No pictures in folder selected for playback.</b> Use [ <b>Playback folder</b> ] item in playback menu to select folder that contains pictures.
All images are hidden.	—	<b>All pictures in current folder are hidden.</b> Use [ <b>Hide image</b> ] item in playback menu to reveal pictures.

Alert		Problem/solution
Monitor	Top control panel	
Cannot display this file.	—	<b>File has been modified using computer application or does not conform to DCF file standard.</b> Do not overwrite images using computer applications.
		<b>File is corrupt.</b> Do not overwrite images using computer applications.
Cannot select this file.	—	<b>Selected picture cannot be retouched.</b> Retouch options are available only with pictures taken with or previously retouched on camera.
This movie cannot be edited.	—	<b>Selected movie cannot be edited.</b> <ul style="list-style-type: none"> <li>• Movies created with other devices cannot be edited.</li> <li>• Movies under two seconds long cannot be edited.</li> </ul>

Alert		Problem/solution
Monitor	Top control panel	
<p>This file cannot be saved to the destination memory card. See the camera's user's manual for details.</p>	—	<p><b>Files 4 GB or larger can only be saved to memory cards formatted for exFAT. They cannot be saved to cards formatted for other file systems, such as FAT32.</b></p> <p>Use a memory card with a capacity over 32 GB formatted in the camera or keep file size to under 4 GB.</p>

# Technical Notes

## Camera Displays

For illustrative purposes, the displays are shown with all indicators lit.

### The Viewfinder

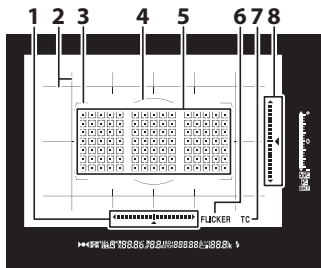

**1** Roll indicator <sup>1, 2</sup>

**2** Framing grid <sup>3</sup>

**3** AF-area brackets

**4** 12-mm reference circle for center-weighted metering

**5** Focus points

Spot metering targets

AF-area mode indicator

**6** Flicker detection

**7** Teleconverter indicator <sup>4</sup>

**8** Pitch indicator <sup>1, 5</sup>

- 1 Displayed by pressing button to which **[Viewfinder virtual horizon]** has been assigned using Custom Setting f3 (**[Custom controls]**).
- 2 Functions as a pitch indicator when the camera is rotated to take pictures in “tall” (portrait) orientation.
- 3 Displayed when **[On]** is selected for Custom Setting d11 **[Framing grid display]**.
- 4 Displayed only when a lens with a built-in teleconverter is attached and the teleconverter is in use.
- 5 Functions as a roll indicator when the camera is rotated to take pictures in “tall” (portrait) orientation.

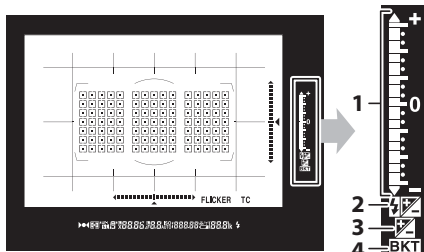

- 1 Exposure indicator  
Exposure  
Exposure compensation  
Exposure and flash  
bracketing progress  
indicator
- 2 Flash compensation indicator
- 3 Exposure compensation  
indicator

- 4 Bracketing indicator  
Exposure and flash  
bracketing  
WB bracketing  
ADL bracketing

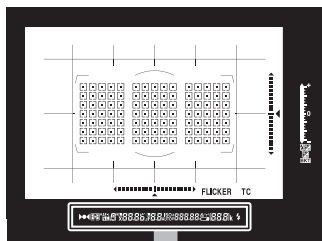

- |   |   |
|---|---|
| 1 | Focus indicator                                   |
| 2 | Metering  |
| 3 | Autoexposure (AE) lock                            |
| 4 | Exposure mode                                     |
| 5 | Shutter speed lock icon                           |
| 6 | Shutter speed<br>Autofocus mode                   |
| 7 | Aperture lock icon                                |
| 8 | Aperture (f-number)<br>Aperture (number of stops) |

- |    |   |
|----|---|
| 9  | ISO sensitivity indicator<br>Auto ISO sensitivity indicator |
| 10 | ISO sensitivity<br>Active D-Lighting amount                 |
| 11 | AF-area mode  |
| 12 | Network display   |



12	Number of exposures remaining Number of shots remaining before memory buffer fills Preset white balance recording indicator Exposure compensation value Flash compensation value PC mode indicator	13	"k" (appears when memory remains for over 1000 exposures)
		14	Flash-ready indicator *
		15	Low battery warning
		16	Aperture stop indicator
		17	Flash sync indicator
		18	FV lock indicator

\* Displayed when an optional flash unit is attached. The flash-ready indicator lights when the flash is charged.

---

### **✓ The Viewfinder**

When the battery is exhausted or no battery is inserted, the display in the viewfinder will dim. The display will return to normal when a charged battery is inserted.

### **✓ Temperature Extremes**

The brightness of the control panel and viewfinder displays varies with temperature, and response times may drop when the temperature is low; the displays will return to normal at room temperature.

---

## The Information Display

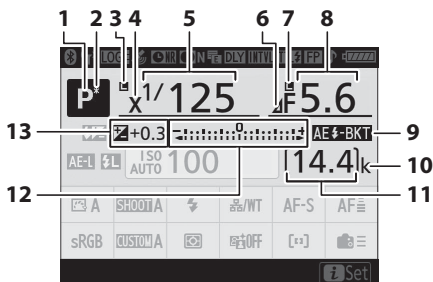

- |   |   |    |   |
|---|---|----|---|
| 1 | Exposure mode                           | 10 | "k" (appears when memory remains for over 1000 exposures) |
| 2 | Flexible program indicator              | 11 | Number of exposures remaining                             |
| 3 | Shutter speed lock icon                 | 12 | Exposure indicator  |
| 4 | Flash sync indicator                    |    | Exposure compensation                                     |
| 5 | Shutter speed                           |    | Exposure and flash bracketing                             |
| 6 | Aperture stop indicator                 |    | WB bracketing   |
| 7 | Aperture lock icon                      |    | ADL bracketing  |
| 8 | Aperture (f-number)                     | 13 | Exposure compensation indicator                           |
| 9 | Exposure and flash bracketing indicator |    | Exposure compensation value                               |
|   | WB bracketing indicator                 |    |   |
|   | ADL bracketing indicator                |    |   |
|   | HDR indicator                           |    |   |
|   | Multiple exposure indicator             |    |   |

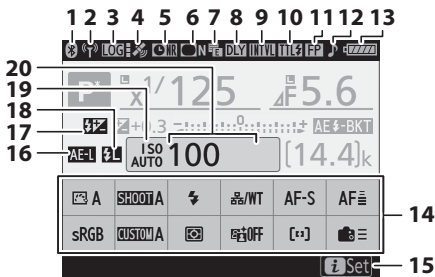

- 1 Bluetooth connection indicator
- 2 Wi-Fi connection indicator
- 3 Track log indicator
- 4 Satellite signal indicator
- 5 Long exposure noise reduction indicator
- 6 Vignette control indicator
- 7 Electronic front-curtain shutter
- 8 Exposure delay mode
- 9 Interval timer indicator
- ☺ (“clock not set”) indicator

- 10 Flash control mode
- 11 FP indicator
- 12 “Beep” indicator
- 13 Battery indicator
- 14 *i* menu display area
- 15 Guide
- 16 Autoexposure (AE) lock
- 17 Flash compensation indicator
- 18 FV lock indicator
- 19 ISO sensitivity indicator
- Auto ISO sensitivity indicator
- 20 ISO sensitivity

---

## ✔ The ⌚ Icon

A flashing ⌚ icon indicates that the camera clock has been reset. The date and time recorded with new photographs will not be correct; use the [Time zone and date] > [Date and time] option in the setup menu to set the clock to the correct time and date.

---

## 🔍 Using the *i* Menu

To access the *i* menu, press the *i* button or tap the guide in the information display. Press the *i* button again or press the info button to return to the information display when settings are complete.



# Live View (Still Photography/Movies)

## ■ Still Photography

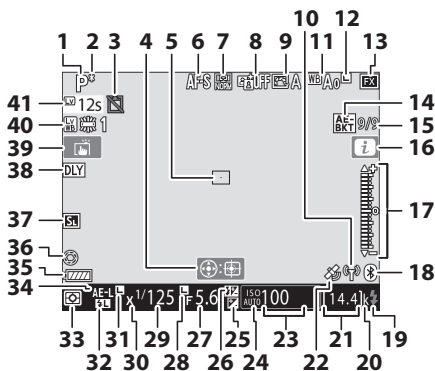

1 Exposure mode

2 Flexible program indicator

3 "No memory card" indicator

4 Subject tracking AF

5 Focus point

6 Autofocus mode

7 AF-area mode

8 Active D-Lighting

9 Picture Control

10 Wi-Fi connection indicator

11 White balance

12 "Auto white balance locked"  
indicator

13	Image area	21	Number of exposures remaining
14	Exposure and flash bracketing indicator	22	Satellite signal indicator
	WB bracketing indicator	23	ISO sensitivity
	ADL bracketing indicator	24	ISO sensitivity indicator
	HDR indicator		Auto ISO sensitivity indicator
	Multiple exposure indicator	25	Exposure compensation indicator
15	Position of current frame in exposure/flash bracketing sequence	26	Flash compensation indicator
	Position of current frame in white balance bracketing sequence	27	Aperture
	ADL bracketing amount	28	Aperture lock icon
	HDR exposure differential	29	Shutter speed
	Number of exposures (multiple exposure)	30	Flash sync indicator
		31	Shutter speed lock icon
16	$\dot{z}$ icon	32	FV lock indicator
17	Exposure indicator	33	Metering
18	Bluetooth connection indicator	34	Autoexposure (AE) lock
	Airplane mode	35	Battery indicator
19	Flash-ready indicator	36	Maximum aperture indicator
20	"k" (appears when memory remains for over 1000 exposures)	37	Silent photography
			Electronic front-curtain shutter
		38	Exposure delay mode

- 39 Touch shooting
  - 40 Photo live view display WB
  - 41 Time remaining  
Temperature warning
- 

### **☑ Temperature Warnings**

- If the camera temperature becomes elevated, a temperature warning and count-down timer will be displayed. When the timer reaches zero, the monitor will turn off.
  - The timer turns red when the thirty second mark is reached. In some cases, the timer may be displayed immediately after the camera is turned on.
-

## ■ Filming

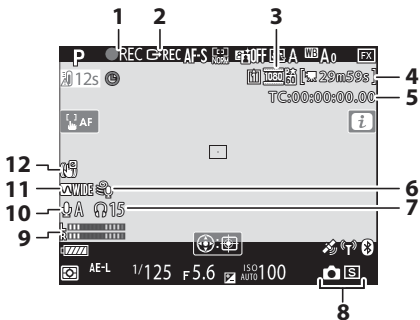

1 Recording indicator  
"No movie" indicator

2 External recording control

3 Frame size and rate/image  
quality

4 Time remaining

5 Time code

6 Wind noise reduction

7 Headphone volume

8 Release mode (still  
photography)

9 Sound level

10 Microphone sensitivity

11 Frequency response

12 Electronic VR indicator



## The Top Control Panel

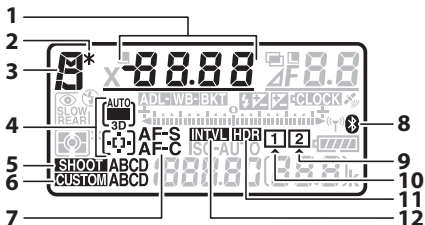

- |          |  |           |   |
|----------|--|-----------|---|
| <b>1</b> | Shutter speed<br>AF-area mode<br>Exposure compensation value<br>Flash compensation value<br>Number of shots in exposure<br>and flash bracketing sequence<br>Number of shots in WB<br>bracketing sequence<br>Overlay mode<br>Number of intervals for<br>interval-timer photography<br>Focal length (non-CPU lenses) | <b>3</b>  | Exposure mode                                       |
| <b>2</b> | Flexible program indicator   | <b>4</b>  | AF-area mode indicator                              |
|          |  | <b>5</b>  | Photo shooting menu bank                            |
|          |  | <b>6</b>  | Custom settings bank                                |
|          |  | <b>7</b>  | Autofocus mode                                      |
|          |  | <b>8</b>  | Bluetooth connection<br>indicator                   |
|          |  | <b>9</b>  | Memory card icon (Slot 2)                           |
|          |  | <b>10</b> | Memory card icon (Slot 1)                           |
|          |  | <b>11</b> | HDR indicator                                       |
|          |  | <b>12</b> | Interval timer indicator<br>Time-lapse on indicator |

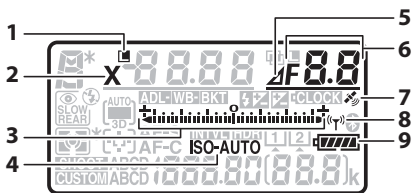

1 Shutter-speed lock icon

2 Flash sync indicator

3 Exposure indicator  
 Exposure  
 Exposure compensation  
 Exposure and flash bracketing  
 WB bracketing  
 ADL bracketing

4 ISO sensitivity indicator  
 Auto ISO sensitivity indicator

5 Aperture stop indicator

6 Aperture (f-number)  
 Aperture (number of stops)

Bracketing increment  
 (exposure and flash bracketing)  
 Bracketing increment (WB bracketing)  
 Number of shots in ADL bracketing sequence

Number of shots per interval  
 HDR exposure differential

Number of exposures  
 (multiple exposure)  
 Maximum aperture (non-CPU lenses)

PC mode indicator

7 Satellite signal indicator

8 Wi-Fi connection indicator

9 Battery indicator

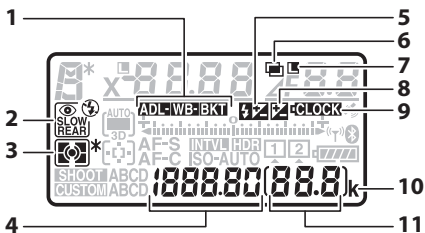

1	Bracketing indicator Exposure and flash bracketing WB bracketing ADL bracketing	10	"k" (appears when memory remains for over 1000 exposures)
2	Flash mode	11	Number of exposures remaining
3	Metering		Number of shots remaining before memory buffer fills
4	Frame count ISO sensitivity White balance preset number		Preset white balance recording indicator
5	Flash compensation indicator		Active D-Lighting amount
6	Multiple exposure indicator		HDR mode
7	Aperture lock icon		Multiple exposure mode
8	Exposure compensation indicator		Manual lens number
9	Clock battery indicator		Time-lapse recording indicator
			Camera control mode

## The Rear Control Panel

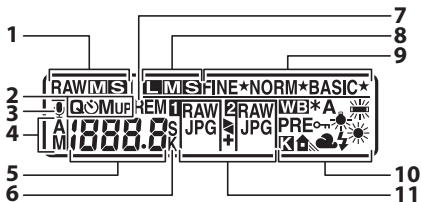

- |   |   |
|---|---|
| 1 | Image size (NEF/RAW)<br>Size for JPEG images recorded to card in Slot 2   |
| 2 | Release mode  |
| 3 | Voice memo status indicator   |
| 4 | Voice memo recording mode   |
| 5 | Release mode<br>Continuous shooting speed<br>Self-timer shot count/self-timer delay<br>Number of exposures remaining<br>Frame count<br>Length of voice memo<br>Sub-option selected for <b>[Auto]</b> or <b>[Fluorescent]</b> white balance<br>White balance preset number<br>Color temperature<br>PC mode indicator |

- |    |  |
|----|--|
| 6  | "k" (appears when memory remains for over 1000 exposures)  |
| 7  | "Remaining" indicator  |
| 8  | Image size (JPEG)  |
| 9  | Image quality  |
| 10 | White balance<br>White balance fine-tuning indicator<br>"Auto white balance locked" indicator<br>White balance preset protection indicator |
| 11 | Role played by memory card in Slot 2<br>Image quality  |

## Compatible F Mount Lenses

CPU lenses are recommended (but note that IX-NIKKOR lenses cannot be used). Types G, E, and D, which grant access to a full range of camera features, are particularly recommended.

### CPU lenses

Lens <sup>1</sup> /accessory	Autofocus <sup>2</sup>	Exposure mode		Metering			
		P S	A M	☒		☒ ☐	☐ <sup>*</sup>
				3D- RGB	RGB		
Type G, E, or D <sup>3</sup> ; AF-S, AF-P, AF-I	✓	✓	✓	✓	—	✓ <sup>4</sup>	✓
PC NIKKOR 19mm f/4E ED <sup>5</sup>	—	✓ <sup>6</sup>	✓ <sup>6</sup>	✓ <sup>6</sup>	—	✓ <sup>4,6</sup>	✓ <sup>6</sup>
PC-E NIKKOR series <sup>5</sup>	—	✓ <sup>6</sup>	✓ <sup>6</sup>	✓ <sup>6</sup>	—	✓ <sup>4,6</sup>	✓ <sup>6</sup>
PC Micro 85mm f/2.8D <sup>5,7</sup>	—	—	✓ <sup>8</sup>	✓ <sup>6</sup>	—	✓ <sup>4,6</sup>	✓ <sup>6</sup>
AF-S/AF-I Teleconverter <sup>9</sup>	✓	✓	✓	✓	—	✓ <sup>4</sup>	✓
Other AF NIKKOR (except lenses for F3AF)	✓ <sup>10</sup>	✓	✓	—	✓	✓ <sup>4</sup>	—
AI-P NIKKOR	—	✓	✓	—	✓	✓ <sup>4</sup>	—

- 1 IX-NIKKOR lenses cannot be used.
  - 2 **M** (manual focus) is available with all lenses.
  - 3 Vibration reduction (VR) is supported with VR lenses.
  - 4 [**Spot metering**] meters the selected focus point.
  - 5 Fog, lines, and other image artifacts (“noise”) may appear in photos taken with the electronic front-curtain shutter. This can be prevented by selecting [**Disable**] for Custom Setting d6 [**Electronic front-curtain shutter**].
  - 6 Cannot be used with shifting or tilting.
  - 7 The camera’s exposure metering and flash control systems will not function as expected when the lens is shifted and/or tilted, or when an aperture other than the maximum aperture is used.
  - 8 Mode **M** (manual) only.
  - 9 For information on the focus points available for autofocus and electronic rangefinding, see “AF-S/AF-I Teleconverters and Available Focus Points” (📖 180).
  - 10 When an AF 80–200mm f/2.8, AF 35–70mm f/2.8, AF 28–85mm f/3.5–4.5 <New>, or AF 28–85mm f/3.5–4.5 lens is focused at the minimum distance at maximum zoom, the in-focus indicator may be displayed when the image on the matte screen in the viewfinder is not in focus. Adjust focus manually until the image in the viewfinder is in focus.
- “Noise” in the form of lines may appear during autofocus at high ISO sensitivities. Use manual focus or focus lock. Lines may also appear at high ISO sensitivities when aperture is adjusted during movie recording or live view photography.

---

## ✔ Lens f-Number

The f-number is a measure of lens “speed”, its maximum (widest) aperture. It appears at the end of the lens name, for example as “f/2.8” or “f/3.5–5.6”.

## ✔ VR Lenses

The lenses listed below are not recommended for long exposures or photographs taken at high ISO sensitivities, as due to the design of the vibration reduction (VR) control system the resulting photos may be marred by fog.

- AF-S VR Zoom-Nikkor 24–120mm f/3.5–5.6G IF-ED
- AF-S VR Zoom-Nikkor 70–200mm f/2.8G IF-ED
- AF-S VR Zoom-Nikkor 70–300mm f/4.5–5.6G IF-ED
- AF-S VR Nikkor 200mm f/2G IF-ED
- AF-S VR Nikkor 300mm f/2.8G IF-ED
- AF-S NIKKOR 16–35mm f/4G ED VR
- AF-S NIKKOR 24–120mm f/4G ED VR
- AF-S NIKKOR 28–300mm f/3.5–5.6G ED VR
- AF-S NIKKOR 400mm f/2.8G ED VR
- AF-S NIKKOR 500mm f/4G ED VR
- AF-S DX VR Zoom-Nikkor 18–200mm f/3.5–5.6G IF-ED
- AF-S DX NIKKOR 16–85mm f/3.5–5.6G ED VR
- AF-S DX NIKKOR 18–200mm f/3.5–5.6G ED VR II
- AF-S DX Micro NIKKOR 85mm f/3.5G ED VR
- AF-S DX NIKKOR 55–300mm f/4.5–5.6G ED VR

We recommend turning vibration reduction off when using other VR lenses.

## ✔ Calculating Angle of View

The camera can be used with Nikon lenses for 35 mm format cameras. If a 35 mm format lens or a lens that supports the FX format is attached, the angle of view will be the same as a frame of 35 mm film.

- You can also take pictures at angles of view that differ from that of the current lens by selecting different options for **[Image area] > [Choose image area]** in the photo shooting menu. For example, if a 35 mm format lens or a lens that supports the FX format is attached, you can reduce the angle of view by selecting **[DX (24×16)]**.

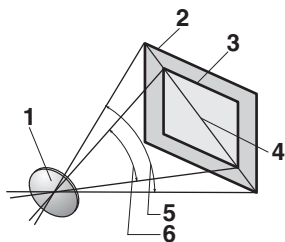

1	Lens
2	<b>[FX (36×24)]</b> picture size (35.9 × 23.9 mm, equivalent to 35 mm format camera)
3	<b>[DX (24×16)]</b> picture size (23.5 × 15.7 mm)
4	Picture diagonal
5	<b>[FX (36×24)]</b> angle of view (35 mm format)
6	<b>[DX (24×16)]</b> angle of view

- The picture diagonal for 35 mm format is about 1.5 times that of the **[DX (24×16)]** crop. Selecting **[DX (24×16)]** therefore multiplies the apparent focal length of 35 mm format lenses attached to the camera by about 1.5×. For example, selecting **[DX (24×16)]** when a lens with a focal length of 50 mm is attached increases the apparent focal length to about 75 mm.



## ✔ Cross Sensors

The availability of cross-sensor focus points varies with the lens used.

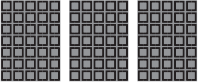
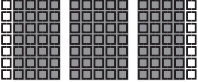
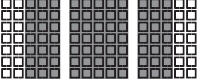
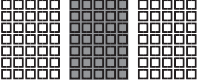
Lens	Cross sensors (cross-sensor focus points highlighted in gray <sup>2)</sup> )
AF-S and AF-P lenses other than those listed below with maximum apertures of f/4 or faster <sup>1</sup>	 <p>105 cross sensors</p>
<ul style="list-style-type: none"><li>• AF-S DX Zoom-Nikkor 12–24mm f/4G IF-ED</li><li>• AF-S NIKKOR 500mm f/4E FL ED VR</li><li>• AF-S NIKKOR 600mm f/4G ED VR</li><li>• AF-S NIKKOR 600mm f/4E FL ED VR</li><li>• AF-S Nikkor 600mm f/4D IF-ED II</li><li>• AF-S Nikkor 600mm f/4D IF-ED</li></ul>	 <p>91 cross sensors</p>
<ul style="list-style-type: none"><li>• AF-S NIKKOR 500mm f/4G ED VR</li><li>• AF-S Nikkor 500mm f/4D IF-ED II</li><li>• AF-S Nikkor 500mm f/4D IF-ED</li></ul>	 <p>77 cross sensors</p>
<ul style="list-style-type: none"><li>• AF-S NIKKOR 200–400mm f/4G ED VR II</li><li>• AF-S VR Zoom-Nikkor 200–400mm f/4G IF-ED</li><li>• AF-S and AF-P lenses with maximum apertures slower than f/4<sup>1</sup></li><li>• Non-AF-S, non-AF-P lenses</li></ul>	 <p>35 cross sensors</p>

1 At maximum zoom, in the case of zoom lenses.

2 Other focus points use line sensors, which detect horizontal lines.

## ☑ AF-S/AF-I Teleconverters and Available Focus Points

When an AF-S or AF-I teleconverter is attached, the focus points shown in the illustrations can be used during viewfinder photography for autofocus and electronic rangefinding (note that at maximum combined apertures slower than  $f/5.6$ , the camera may not be able to focus on dark or low-contrast subjects).

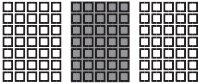
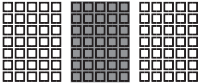
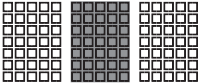
Teleconverter	Max. lens aperture <sup>1</sup>	Available focus points (cross-sensor focus points highlighted in gray <sup>2</sup> )
TC-14E, TC-14E II, TC-14E III TC-17E II TC-20E, TC-20E II, TC-20E III	$f/2$	 <ul style="list-style-type: none"><li>• 105 focus points</li><li>• 105 cross sensors</li></ul>
TC-14E, TC-14E II, TC-14E III	$f/2.8$	 <ul style="list-style-type: none"><li>• 105 focus points</li><li>• 35 cross sensors</li></ul>
TC-17E II TC-20E, TC-20E II, TC-20E III	$f/2.8$	 <ul style="list-style-type: none"><li>• 105 focus points</li><li>• 35 cross sensors</li></ul>
TC-14E, TC-14E II, TC-14E III	$f/4$	 <ul style="list-style-type: none"><li>• 105 focus points</li><li>• 35 cross sensors</li></ul>

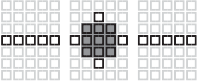
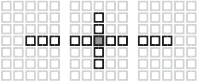
Teleconverter	Max. lens aperture <sup>1</sup>	Available focus points (cross-sensor focus points highlighted in gray <sup>2</sup> )
TC-17E II	f/4	 <ul style="list-style-type: none"> <li>• 23 focus points</li> <li>• 9 cross sensors</li> </ul>
TC-800-1.25E ED	f/5.6	
TC-20E, TC-20E II, TC-20E III	f/4	 <ul style="list-style-type: none"> <li>• 15 focus points</li> <li>• 1 cross sensor</li> </ul>
TC-14E, TC-14E II, TC-14E III	f/5.6	

1 At maximum zoom, in the case of zoom lenses.

2 Other focus points use line sensors, which detect horizontal lines.

Autofocus is not available when teleconverters are used with AF-S VR Micro-Nikkor 105mm f/2.8G IF-ED lenses.

---

## ☑ Recognizing CPU and Type G, E, and D Lenses

CPU lenses can be identified by the presence of CPU contacts (①). Type G lenses are marked with a “G”, type E lenses with an “E”, and type D lenses with a “D”. Type G and E lenses are not equipped with a lens aperture ring (②).

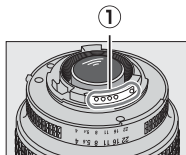

CPU lens

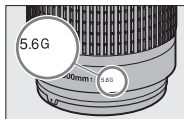

Type G or E lens

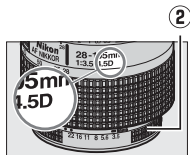

Type D lens

## Non-CPU lenses and Other Accessories

Lens <sup>1</sup> /accessory	Exposure mode		Metering			
	P S	A M	☒		☒	☒ <sup>*</sup>
			3D- RGB	RGB	☒	☒
AI-, AI-modified NIKKOR or Nikon Series E lenses <sup>2</sup>	—	✓ <sup>3</sup>	—	✓ <sup>4</sup>	✓ <sup>5</sup>	—
Medical-NIKKOR 120mm f/4	—	✓ <sup>6</sup>	—	—	—	—
Reflex-NIKKOR	—	✓ <sup>3</sup>	—	—	✓ <sup>5</sup>	—
PC-NIKKOR	—	✓ <sup>7</sup>	—	—	✓	—
AI-type Teleconverter <sup>8</sup>	—	✓ <sup>3</sup>	—	✓ <sup>4</sup>	✓ <sup>5</sup>	—
PB-6 Bellows Focusing Attachment <sup>9</sup>	—	✓ <sup>10</sup>	—	—	✓	—
Auto extension rings (PK-series 11A, 12, or 13; PN-11)	—	✓ <sup>3</sup>	—	—	✓	—

- 1 Some lenses cannot be used (☒ 185).
- 2 The range of rotation for the AI 80–200mm f/2.8 ED tripod mount is limited by the camera body. Filters cannot be exchanged while an AI 200–400mm f/4 ED is mounted on camera.
- 3 If the maximum aperture is specified using the **[Non-CPU lens data]** item in the setup menu, the aperture value will be displayed in the viewfinder and control panel.

- 4 Can be used only if the lens focal length and maximum aperture are specified using the [**Non-CPU lens data**] item in the setup menu. Some lenses may, however, fail to produce the desired results even if the focal length and maximum aperture are supplied. Use [**Spot metering**] or [**Center-weighted metering**] if the desired results are not achieved.
  - 5 For improved precision, specify the lens focal length and maximum aperture using the [**Non-CPU lens data**] item in the setup menu.
  - 6 Can be used in mode **M** at shutter speeds one step or more slower than the flash sync speed.
  - 7 Use stop-down metering. In mode **A**, stop aperture down using the controls on the lens and lock exposure before shifting the lens. In mode **M**, stop aperture down using the controls on the lens and meter exposure before shifting the lens.
  - 8 Exposure compensation required with AI 28–85mm f/3.5–4.5, AI 35–105mm f/3.5–4.5, AI 35–135mm f/3.5–4.5, or AF-S 80–200mm f/2.8D lenses.
  - 9 Requires a PK-12 or PK-13 auto extension ring. A PB-6D may be required depending on camera orientation.
  - 10 Can be used with stop-down metering; in mode **A**, stop aperture down using the controls on the bellows attachment and meter exposure before taking photographs.
- Lines may appear at high ISO sensitivities when aperture is adjusted during movie recording or live view photography.

---

## ❑ Incompatible Lenses and Accessories

The following non-CPU lenses and accessories cannot be used. Attempting to mount them on the camera could damage the camera or lens.

- TC-16A AF teleconverters
  - Non-AI lenses (lenses with pre-AI exposure couplings)
  - Lenses that require the AU-1 focusing unit (400mm f/4.5, 600mm f/5.6, 800mm f/8, 1200mm f/11)
  - Fisheye (6mm f/5.6, 7.5mm f/5.6, 8mm f/8, OP 10mm f/5.6)
  - 2.1cm f/4
  - K2 extension rings
  - 180–600mm f/8 ED lenses (serial numbers 174041–174180)
  - 360–1200mm f/11 ED lenses (serial numbers 174031–174127)
  - 200–600mm f/9.5 lenses (serial numbers 280001–300490)
  - AF lenses for the F3AF (AF 80mm f/2.8, AF 200mm f/3.5 ED, TC-16 AF teleconverters)
  - PC 28mm f/4 lenses (serial numbers 180900 or earlier)
  - PC 35mm f/2.8 lenses (serial numbers 851001–906200)
  - PC 35mm f/3.5 lenses (old type)
  - Reflex 1000mm f/6.3 lenses (old type)
  - Reflex 1000mm f/11 lenses (serial numbers 142361–143000)
  - Reflex 2000mm f/11 lenses (serial numbers 200111–200310)
-

---

## ☑ **Compatible Non-CPU Lenses**

- Specifying the lens focal length and maximum aperture using the [**Non-CPU lens data**] item in the setup menu allows many of the features available with CPU lenses, including aperture value display and color matrix metering, to be used with non-CPU lenses. If the focal length and maximum aperture are not provided and [**Matrix metering**] is selected for metering, [**Center-weighted metering**] will be used instead.
  - Aperture must be set using the lens aperture ring. If the maximum aperture is not provided using [**Non-CPU lens data**], the aperture displays in the camera top control panel and viewfinder will show the number of stops from maximum aperture and the actual aperture value must be read off the lens aperture ring.
-



# The Electronic Rangefinder

The conditions under which the electronic rangefinder can be used vary with the lens.

## ■ CPU lenses

Lens/accessory	Viewfinder photography	Live view
Type G, E, or D; AF-S, AF-P, AF-I	✓	—
PC NIKKOR 19mm f/4E ED	✓ <sup>1</sup>	—
PC-E NIKKOR series	✓ <sup>1</sup>	—
PC Micro 85mm f/2.8D	✓ <sup>1</sup>	—
AF-S/AF-I Teleconverter	✓	—
Other AF NIKKOR (except lenses for F3AF)	✓ <sup>2</sup>	—
AI-P NIKKOR	✓ <sup>3</sup>	—

- 1 Cannot be used with shifting or tilting.
- 2 When an AF 80–200mm f/2.8, AF 35–70mm f/2.8, AF 28–85mm f/3.5–4.5 <New>, or AF 28–85mm f/3.5–4.5 lens is focused at the minimum distance at maximum zoom, the in-focus indicator may be displayed when the image on the matte screen in the viewfinder is not in focus. Adjust focus manually until the image in the viewfinder is in focus.
- 3 With a maximum aperture of f/5.6 or faster.

## ■ Non-CPU Lenses and Other Accessories

Lens/accessory	Viewfinder photography	Live view
AI-, AI-modified NIKKOR or Nikon Series E lenses	✓ <sup>1</sup>	—
Medical-NIKKOR 120mm f/4	✓	—
Reflex-NIKKOR	—	—
PC-NIKKOR	✓ <sup>2</sup>	—
AI-type Teleconverter	✓ <sup>3</sup>	—
PB-6 Bellows Focusing Attachment	✓ <sup>3</sup>	—
Auto extension rings (PK-series 11A, 12, or 13; PN-11)	✓ <sup>3</sup>	—

- 1 With a maximum aperture of f/5.6 or faster.
- 2 Cannot be used with shifting or tilting.
- 3 With a maximum effective aperture of f/5.6 or faster.



## Compatible Flash Units

### The Nikon Creative Lighting System (CLS)





Nikon's advanced Creative Lighting System (CLS) supports a variety of features thanks to improved communication between the camera and compatible flash units.

### ■ Features Available with CLS-Compatible Flash Units

Supported features			Flash unit								
			SB-5000	SB-800	SB-910/ SB-900/ SB-800	SB-700	SB-600	SB-500	SU-800	SB-R200	SB-400
Single flash	i-TTL	i-TTL balanced fill-flash for digital SLR <sup>1</sup>	✓	✓	✓	✓	✓	—	—	✓	✓
		Standard i-TTL fill-flash for digital SLR	✓ <sup>2</sup>	✓ <sup>2</sup>	✓	✓ <sup>2</sup>	✓	—	—	✓	✓
	 <b>A</b>	Auto aperture	✓	✓ <sup>3</sup>	—	—	—	—	—	—	—
	<b>A</b>	Non-TTL auto	—	✓ <sup>3</sup>	—	—	—	—	—	—	—
	<b>GN</b>	Distance-priority manual	✓	✓	✓	—	—	—	—	—	—
	<b>M</b>	Manual	✓	✓	✓	✓	✓ <sup>4</sup>	—	—	✓ <sup>4</sup>	✓ <sup>4</sup>
	<b>RPT</b>	Repeating flash	✓	✓	—	—	—	—	—	—	—

Supported features		Flash unit								
		SB-5000	SB-800	SB-910/ SB-900/ SB-800	SB-700	SB-600	SB-500	SU-800	SB-R200	SB-400
Master	Remote flash control	✓	✓	✓	—	✓ <sup>4</sup>	✓	—	—	—
	<b>i-TTL</b> i-TTL	✓	✓	✓	—	✓ <sup>4</sup>	—	—	—	—
	<b>[A : B]</b> Quick wireless flash control	✓	—	✓	—	—	—	✓ <sup>5</sup>	—	—
	 <b>A</b> Auto aperture	✓	✓	—	—	—	—	—	—	—
	<b>A</b> Non-TTL auto	—	—	—	—	—	—	—	—	—
	<b>M</b> Manual	✓	✓	✓	—	✓ <sup>4</sup>	—	—	—	—
	<b>RPT</b> Repeating flash	✓	✓	—	—	—	—	—	—	—
	<b>i-TTL</b> i-TTL	✓	✓	✓	✓	✓	—	✓	—	—
	<b>[A : B]</b> Quick wireless flash control	✓	✓	✓	✓	✓	—	✓	—	—
	 <b>A/A</b> Auto aperture/non-TTL auto	✓ <sup>6</sup>	✓ <sup>6</sup>	—	—	—	—	—	—	—
Remote	<b>M</b> Manual	✓	✓	✓	✓	✓	—	✓	—	—
	<b>RPT</b> Repeating flash	✓	✓	✓	✓	✓	—	—	—	—

Supported features	Flash unit									
	SB-5000	SB-900/ SB-800	SB-910/ SB-900/ SB-800	SB-700	SB-600	SB-500	SU-800	SB-R200	SB-400	SB-300
Radio-controlled Advanced Wireless Lighting	✓ <sup>7</sup>	—	—	—	—	—	—	—	—	—
Color Information Communication (flash)	✓	✓	✓	✓	✓	✓	—	—	✓	✓
Color Information Communication (LED light)	—	—	—	—	—	✓	—	—	—	—
Auto FP high-speed sync <sup>8</sup>	✓	✓	✓	✓	✓	✓	✓	✓	—	—
FV lock <sup>9</sup>	✓	✓	✓	✓	✓	✓	✓	✓	✓	✓
Red-eye reduction	✓	✓	✓	✓	✓	✓	—	—	✓	—
Camera modeling illumination	✓	✓	✓	✓	✓	✓	✓	✓	—	—
Unified flash control	✓	—	—	—	—	✓	—	—	✓	✓
Camera flash unit firmware update	✓	✓ <sup>10</sup>	✓	—	—	✓	—	—	—	✓

- 1 Not available with spot metering.
- 2 Can also be selected via the flash unit.
- 3 A/A mode selection is performed on the flash unit using custom settings.
- 4 Can be selected using the [**Flash control**] item in the camera menus.
- 5 Available during close-up photography only.
- 6 Choice of A and A depends on the option selected with the master flash.
- 7 Supports the same features as remote flash units with optical AWL.
- 8 Available only in i-TTL, A, A, GN, and M flash-control modes.
- 9 Available only in i-TTL flash control mode or when the flash is configured to emit monitor preflashes in A or A flash control mode.
- 10 Firmware updates for the SB-910 and SB-900 can be performed from the camera.

## ■ The SU-800 Wireless Speedlight Commander

When mounted on a CLS-compatible camera, the SU-800 can be used as a commander for SB-5000, SB-910, SB-900, SB-800, SB-700, SB-600, SB-500, or SB-R200 flash units. Group flash control is supported for up to three groups. The SU-800 itself is not equipped with a flash.

### ✓ Other Flash Units

The following flash units can be used in non-TTL auto (**A**) and manual modes. The options available do not vary with the lens used.

Supported features		Flash unit					
		SB-80DX SB-28DX	SB-50DX	SB-28 SB-26 SB-25 SB-24	SB-30 SB-27 <sup>1</sup> SB-22S SB-22 SB-20 SB-16B SB-15	SB-23 SB-29 SB-21B SB-29S	
Flash mode	<b>A</b>	Non-TTL auto	✓	—	✓	✓	—
	<b>M</b>	Manual	✓	✓	✓	✓	✓
		Repeating flash	✓	—	✓	—	—
	<b>REAR</b> <sup>2</sup>	Rear-curtain sync	✓	✓	✓	✓	✓

- 1 Mounting an SB-27 on the camera automatically sets the flash mode to **TTL**, but setting the flash mode to **TTL** disables the shutter release. Set the SB-27 to **A**.
- 2 Available when the camera is used to select the flash mode.

## ✔ Metering Areas for FV Lock

The areas metered when FV lock is used with optional flash units are as follows:

Picture taken with	Flash control mode	Metered area
Stand-alone flash unit	i-TTL	6-mm circle in center of frame
	Auto aperture (⊗A)	Area metered by flash exposure meter
Remote flash units controlled via Advanced Wireless Lighting	i-TTL	Entire frame
	Auto aperture (⊗A)	Area metered by flash exposure meter
	Non-TTL auto (A)	

## ✔ Notes on Optional Flash Units

- Refer to the flash unit manual for detailed instructions.
- If the unit supports CLS, refer to the section on CLS-compatible digital SLR cameras. This camera is not included in the “digital SLR” category in the SB-80DX, SB-28DX, and SB-50DX manuals.
- If the flash-ready indicator (⚡) flashes for about three seconds after a photograph is taken in i-TTL or non-TTL auto mode, the flash has fired at full power and the photograph may be underexposed (CLS-compatible flash units only).
- i-TTL flash control can be used at ISO sensitivities between 100 and 12800.



- At ISO sensitivities over 12800, the desired results may not be achieved at some ranges or aperture settings.
- In mode **P**, the maximum aperture (minimum f-number) is limited according to ISO sensitivity, as shown below:

<b>Maximum aperture (f-number) at ISO equivalent of:</b>							
<b>100</b>	<b>200</b>	<b>400</b>	<b>800</b>	<b>1600</b>	<b>3200</b>	<b>6400</b>	<b>12800</b>
4	5	5.6	7.1	8	10	11	13

- \* If the maximum aperture of the lens is smaller than given above, the maximum value for aperture will be the maximum aperture of the lens.
- The SB-5000, SB-910, SB-900, SB-800, SB-700, SB-600, SB-500, and SB-400 provide red-eye reduction in red-eye reduction and slow-sync with red-eye reduction flash modes.
- "Noise" in the form of lines may appear in flash photographs taken with an SD-9 or SD-8A high-performance battery pack attached directly to the camera. Reduce ISO sensitivity or increase the distance between the camera and the battery pack.
- The SB-5000, SB-910, SB-900, SB-800, SB-700, SB-600, and SU-800 provide AF-assist illumination as required.

- During viewfinder photography, the focus points for which AF illumination is available vary with focal length.

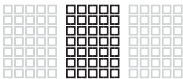
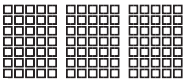
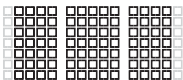
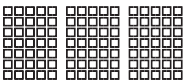
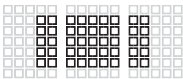
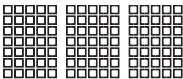
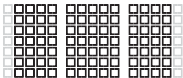
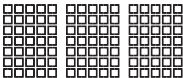
<b>Flash unit</b>	<b>Examples of focus points for which AF-assist illumination is available</b>	
<b>SB-5000</b>	<b>Focal length 24 mm</b>	<b>Focal length 135 mm</b>
		
<b>SB-910/ SB-900</b>	<b>Focal length 17 mm</b>	<b>Focal length 135 mm</b>
		
<b>SB-800/ SB-600/ SU-800 wireless speedlight commander</b>	<b>Focal length 24 mm</b>	<b>Focal length 105 mm</b>
		
<b>SB-700</b>	<b>Focal length 24 mm</b>	<b>Focal length 135 mm</b>
		

- Depending on the lens used and scene recorded, the in-focus indicator (●) may be displayed when the subject is not in focus, or the camera may be unable to focus and the shutter release will be disabled.

- When an SC-series 17, 28, or 29 sync cable is used for off-camera flash photography, correct exposure may not be achieved in i-TTL mode. We recommend that you select standard i-TTL fill-flash. Take a test shot and view the results in the monitor.
- In i-TTL, do not use any form of flash panel (diffusion panel) other than the flash unit's built-in flash panel or bounce adapters provided with the flash unit. Using other panels may produce incorrect exposure.

### ✔ **Flash Compensation for Optional Flash Units**

In i-TTL and auto aperture (A) flash control modes, the flash compensation selected with the optional flash unit or the **[Flash control]** item in the photo shooting menu is added to the flash compensation selected with the (Fn) (⚡) button.

---

### 🔍 **Modeling Illumination**

- Optional CLS-compatible flash units emit a modeling flash when the camera **Pv** button is pressed.
  - This feature can be used with Advanced Wireless Lighting to preview the total lighting effect achieved with multiple flash units.
  - Modeling illumination can be turned off by selecting **[Off]** for Custom Setting e6 **[Modeling flash]**.
-

## Other Compatible Accessories

A variety of accessories are available for your Nikon camera.

### ● Power Sources

- **EN-EL18c Rechargeable Li-ion Battery:** EN-EL18c batteries can be used with Nikon D6 digital cameras. EN-EL18c batteries can be charged and calibrated using MH-26a battery chargers.
  - EN-EL18b/EN-EL18a/EN-EL18 batteries can also be used. Note, however, that fewer pictures can be taken on a single charge with an EN-EL18 than with an EN-EL18c/EN-EL18b/EN-EL18a (☐ 263).
- **MH-26a Battery Charger:** The MH-26a can be used to recharge EN-EL18c/EN-EL18b/EN-EL18a/EN-EL18 batteries. The MH-26a can also be used to calibrate batteries.
  - MH-26 battery chargers can be used in place of the MH-26a.
- **EP-6 Power Connector, EH-6c AC Adapter:** Use AC adapters to power the camera for extended periods.
  - The EP-6 is needed to connect the EH-6c to the camera. See “Attaching a Power Connector and AC Adapter” (☐ 207) for details.
  - EH-6b, EH-6a, and EH-6 AC adapters can be used in place of the EH-6c.

## ● Accessory Shoe Covers

**BS-3/BS-1 Accessory Shoe Covers:** Accessory shoe covers protect the accessory shoe when no flash unit is attached (□ 204).

## ● Body Caps

**BF-1B Body Cap/BF-1A Body Cap:** Body caps prevent dust entering the camera when no lens is in place.

## ● Viewfinder Eyepiece Accessories

- **DK-19 Rubber Eyecup:** A rubber eyecup that can be fitted to the camera viewfinder. The DK-19 makes the image in the viewfinder easier to see, preventing eye fatigue.
- **DK-17C Diopter-Adjustment Viewfinder Lenses:** These lenses can be dropped into the viewfinder eyepiece to accommodate the needs of far- and near-sighted photographers. Choose from lenses with diopters of  $-3$ ,  $-2$ ,  $0$ ,  $+1$ , and  $+2 \text{ m}^{-1}$ . Be sure to try the lenses in the store before purchase, as results can vary widely from person to person. Diopter adjustment lenses (□ 205) can be used for diopters beyond the range of the camera's diopter adjustment control ( $-3$  to  $+1 \text{ m}^{-1}$ ).
- **DK-17M Magnifying Eyepiece:** When fitted to the camera viewfinder, the DK-17M increases magnification by approximately  $1.2\times$ .
- **DG-2 Eyepiece Magnifier:** The DG-2 magnifies the scene at the center of the viewfinder. Use it in situations requiring especially precise focus.
- **DK-18 Eyepiece Adapter:** An adapter used when attaching DG-2 magnifiers or DR-3 right-angle viewing attachments (□ 205).
- **DK-27 Eyepiece Adapter:** A DK-27 is supplied with the camera.
- **DK-14/DK-17A Antifog Finder Eyepieces:** These viewfinder eyepieces prevent fogging in humid or cold conditions.

- **DK-17F Fluorine-Coated Finder Eyepiece:** A DK-17F is supplied with the camera. The protective glass features Nikon's unique, easy-to-clean fluorine coating on both surfaces.
- **DR-5 Right-Angle Viewing Attachment:** The DR-5 attaches to the viewfinder eyepiece at a right angle, allowing the image in the viewfinder to be viewed from above when the camera is used to take pictures in "wide" (landscape) orientation. Choose from magnifications of 1× and 2× \*, the former to view the entire frame and the latter for greater precision when focusing. Diopter adjustment is also supported.
  - \* The edges of the frame are not visible when the view is magnified.
- **DR-4 Right-Angle Viewing Attachment:** The DR-4 attaches to the viewfinder eyepiece at a right angle, allowing the image in the viewfinder to be viewed from above when the camera is used to take pictures in "wide" (landscape) orientation.

### ● Filters

- Neutral Color (NC) filters can be used to protect the lens.
- The camera cannot be used with linear polarizing filters. Use the C-PL or C-PLII circular polarizing filter instead.
- Filters may cause ghosting when the subject is framed against a bright light, or when a bright light source is in the frame. Filters can be removed if ghosting occurs.
- RGB and 3D-RGB matrix metering may not produce the desired results with filters with exposure factors (filter factors) over 1× (Y44, Y48, Y52, O56, R60, X0, X1, C-PL, ND2S, ND4, ND4S, ND8, ND8S, ND400, A2, A12, B2, B8, B12); we suggest that [**Center-weighted metering**] be selected instead. See the filter manual for details.
- Filters intended for special-effects photography may interfere with autofocus or the electronic rangefinder.

## ● **Wireless Transmitters** <sup>1,2</sup>

**WT-6 Wireless Transmitters:** Use a wireless transmitter to upload pictures over a wireless network or control the camera from a computer running Camera Control Pro 2 (available separately). You can also take and browse pictures remotely from a computer or smart device.

- 1 Requires a wireless network and some basic network knowledge. Be sure to update the wireless transmitter software to the latest version.
- 2 WT-5 wireless transmitters cannot be used.

## ● **Wireless Remote Controllers**

• **WR-R10/WR-T10 Wireless Remote Controllers:** When a WR-R10 is connected to the ten-pin remote terminal using a WR-A10 adapter, the camera can be controlled remotely using a WR-T10 wireless remote controller.

- The WR-R10 can also be used to control radio-controlled flash units.
- For synchronized release involving more than one camera, ready multiple cameras with paired WR-R10 units attached.

• **WR-1 Wireless Remote Controller:** WR-1 units are used with WR-R10 or WR-T10 wireless remote controllers or with other WR-1 remote controllers, with the WR-1 units functioning as either transmitters or receivers. When a WR-R10 or a WR-1 configured as a receiver is connected to the ten-pin remote terminal, a WR-T10 or a second WR-1 configured as a transmitter can be used to take pictures remotely. Camera settings can also be adjusted using a WR-1 configured as a transmitter.

\* Be sure the firmware for the WR-R10 and WR-1 has been updated to the latest versions (WR-R10 firmware version 3.0 or later and WR-1 firmware version 1.0.1 or later). For information on firmware updates, see the Nikon website for your area. Consult a Nikon-authorized service representative when updating the firmware for the WR-R10 from versions prior to version 2.0 to version 3.0 or later.

## ● Remote Terminal Accessories

The camera is equipped with a ten-pin remote terminal for remote control and automatic photography.

Be sure to replace the terminal cap when the terminal is not in use. Dust or other foreign matter accumulating in the terminal contacts could cause the camera to malfunction.

- **MC-22/MC-22A Remote Cords (length approximately 1 m/3.3 ft):** Remote shutter releases with blue, yellow, and black terminals for connection to remote shutter-triggering devices, allowing control via sound or electronic signals.
- **MC-30/MC-30A Remote Cords (length approximately 80 cm/2.7 ft):** Remote shutter releases; can be used to reduce camera shake.
- **MC-36/MC-36A Remote Cords (length approximately 85 cm/2.8 ft):** Remote shutter releases with timers for interval-timer photography.
- **MC-21/MC-21A Extension Cords (length approximately 3 m/9.9 ft):** Can be connected to ML-3 or MC-series 20, 22, 22A, 23, 23A, 25, 25A, 30, 30A, 36, or 36A, but note that two or more extensions cords cannot be connected together.
- **MC-23/MC-23A Connecting Cords (length approximately 40 cm/1.4 ft):** Use an MC-23 or 23A to connect two cameras via their ten-pin terminals for simultaneous operation.
- **MC-25/MC-25A Adapter Cords (length approximately 20 cm/7.9 in.):** Ten-pin to two-pin adapter cords for connection to devices with two-pin terminals, including the MW-2 radio control set, MT-2 intervalometer, and ML-2 modulite control set.
- **WR-A10 WR Adapter:** An adapter used to connect WR-R10 wireless remote controllers to cameras with ten-pin remote terminals.
- **ML-3 Modulite Remote Control Set:** Allows infrared remote control at ranges of up to 8 m (26.2 ft).



## ● USB Cables

- **UC-E24 USB Cable:** A USB cable with a type C connector for connection to the camera and a type A connector for connection to the USB device.
- **UC-E25 USB Cable:** A USB cable with two type C connectors.

## ● HDMI Cables

**HC-E1 HDMI Cable:** An HDMI cable with a type C connector for connection to the camera and a type A connector for connection to HDMI devices.

## ● Microphones

- **ME-1 Stereo Microphone:** Connect the ME-1 to the camera microphone jack to record stereo sound. Using an external microphone also reduces the chance of picking up equipment noise, such as the sounds produced by the lens during autofocus.
- **ME-W1 Wireless Microphone:** A wireless Bluetooth microphone. Use the ME-W1 for off-camera recording.

## ● Connector Covers

**UF-6 Connector Cover for Stereo Mini-Plug Cables:** Prevents accidental disconnection of mini-plug cables for optional ME-1 stereo microphones.

---

### ✔ **Compatible Accessories**

- Availability may vary with country or region.
- See our website or brochures for the latest information.

### ✔ **The BS-3 Accessory Shoe Cover**

The supplied accessory shoe cover can be used to protect the accessory shoe or to prevent light reflected from the metal parts of the shoe appearing in photographs. The cover slides into the shoe as shown. To remove the cover, hold the camera firmly, press the cover down with a thumb and slide it in the direction shown.

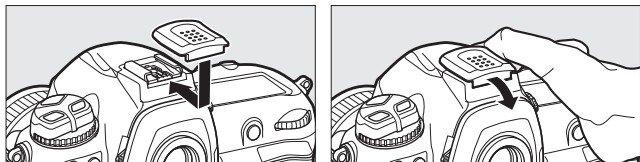

### ✔ Attaching Diopter-Adjustment Viewfinder Lenses

Remove the DK-17F viewfinder eyepiece before attaching a diopter-adjustment viewfinder lens. Press the latches on both sides of the eyepiece adapter simultaneously to release the eyepiece lock (①) and then unscrew the eyepiece as shown (②).

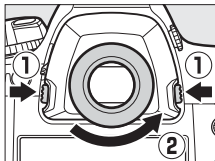

### ✔ Removing the Eyepiece Adapter

Press and lift the latches on both sides simultaneously (①) and remove the adapter as shown (②).

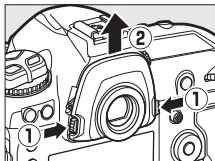

## ✔ The HDMI/USB Cable Clip

To prevent accidental disconnection, attach the supplied clip to HDMI cables or to the supplied USB cable as shown (note that the clip may not fit all third-party HDMI cables). The illustrations show the USB cable.

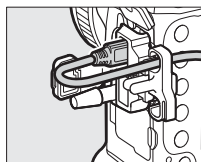
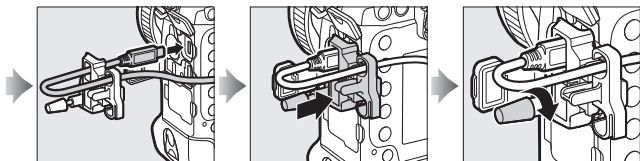
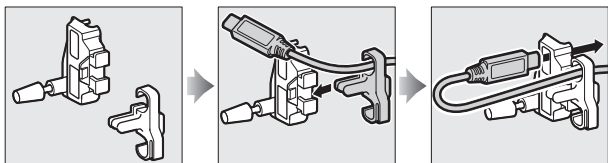

USB cable

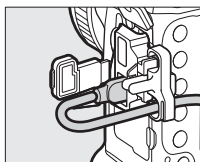

HDMI cable

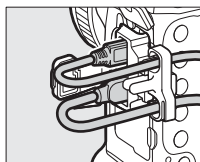

HDMI cable and USB  
cable used  
simultaneously

## **Attaching a Power Connector and AC Adapter**

Turn the camera off before attaching an optional power connector and AC adapter.

### **1 Remove the BL-6 battery-chamber cover.**

Lift the battery-chamber cover latch, turn it to the open (⊞) position (①), and remove the BL-6 battery-chamber cover (②).

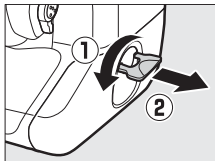

### **2 Connect the EH-6c AC adapter to the EP-6 power connector.**

- Pass the DC cable over the power connector cable guide (①) and slide it down until it is at the bottom of the slot.
- Insert the DC plug into the DC IN connector (②).

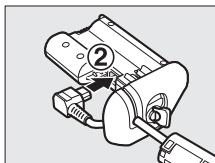
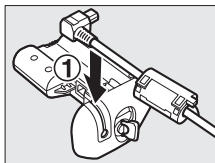

### 3 Insert the power connector.

Fully insert the power connector into the battery chamber as shown.

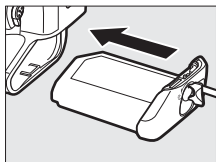

### 4 Latch the power connector.

- Rotate the latch to the closed position (①) and fold it down as shown (②).

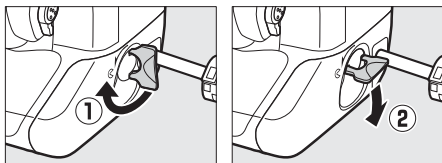

- To prevent the power connector being dislodged during operation, be sure that it is securely latched.
- The battery level is not displayed in the top control panel while the camera is powered by the AC adapter and power connector.

# Software

The following Nikon software can be used with the camera:

## ● Computer Software

Nikon computer software is available from the Nikon Download Center. Check the version and system requirements and be sure to download the latest version.

<https://downloadcenter.nikonimglib.com/>

- **Camera Control Pro 2** (available for purchase): Control the camera remotely from a computer and save photographs directly to the computer hard disk. A PC connection indicator (P ) will be displayed in the camera top control panel if Camera Control Pro 2 is launched while the camera is connected to the computer.
- **NX Tether**: Use for tethered photography when the camera is connected to a computer. Exposure, white balance, and other camera settings can be adjusted remotely using controls in the computer display.
- **NX Studio** \*: View and edit photos and videos shot with Nikon digital cameras. NX Studio can be used to fine-tune files in Nikon's unique NEF/NRW (RAW) format and convert them to JPEG or TIFF (NEF/RAW processing). It supports not only NEF/NRW (RAW) pictures but also JPEG and TIFF photos shot with Nikon digital cameras for such tasks as editing tone curves and enhancing brightness and contrast.  
\* Existing users should be sure to download the latest version, as earlier versions may be unable to download pictures from the camera or open NEF (RAW) pictures.

- **Wireless Transmitter Utility:** The Wireless Transmitter Utility is required if the camera is to be connected to a network. Pair the camera with the computer and download pictures via Wi-Fi.

● **Smartphone (Tablet) Apps**

Smartphone apps can be downloaded from the Apple App Store® or on Google Play™. Visit the Nikon website for the latest information.

**SnapBridge:** Download photos and movies from the camera to your smart device via a wireless connection.



# Caring for the Camera

## **Storage**

When the camera will not be used for an extended period, remove the battery. Before removing the battery, confirm that the camera is off.

Do not store the camera in locations that:

- are poorly ventilated or subject to humidities of over 60%
- are next to equipment that produces strong electromagnetic fields, such as televisions or radios
- are exposed to temperatures above 50 °C (122 °F) or below –10 °C (14 °F)

## **Cleaning**

The procedure varies with the part that requires cleaning. The procedures are detailed below.

- Do not use alcohol, thinner, or other volatile chemicals.

## ■ Camera Body

Use a blower to remove dust and lint, then wipe gently with a soft, dry cloth. After using the camera at the beach or seaside, wipe off sand or salt with a cloth lightly dampened in distilled water and dry the camera thoroughly.

**Important:** *Dust or other foreign matter inside the camera may cause product malfunction. Damage due to the presence of foreign matter inside the camera is not covered under warranty.*

## ■ Lens, Mirror, and Viewfinder

These glass elements are easily damaged: remove dust and lint with a blower. If using an aerosol blower, keep the can vertical to prevent the discharge of liquid that could damage glass elements. To remove fingerprints and other stains, apply a small amount of lens cleaner to a soft cloth and clean with care.

## ■ Monitor

Remove dust and lint with a blower. When removing fingerprints and other stains, wipe the surface lightly with a soft cloth or chamois leather. Do not apply pressure, as this could result in damage or malfunction.

## The Low-Pass Filter

Dirt or dust entering the camera when lenses are exchanged or the body cap is removed may adhere to the low-pass filter and affect your photographs. The “clean image sensor” option vibrates the filter to remove dust.

The filter can be cleaned at any time from the menus, or cleaning can be performed automatically when the camera is turned on or off.

### ■ ■ Using the Menus

- For maximum effect, hold the camera in normal orientation (base down).

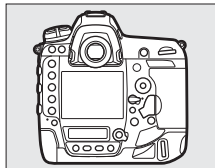

- Select [**Clean image sensor**] in the setup menu, then highlight [**Clean now**] and press **OK** to begin cleaning.

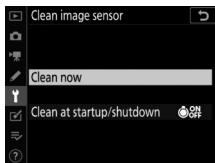

- Camera controls cannot be used while cleaning is in progress. Do not remove or disconnect the power source.
- The setup menu will be displayed when cleaning is complete.

## ■ Cleaning the Image Sensor at Startup and/or Shutdown

Option	Description
● ON [Clean at startup]	The image sensor is automatically cleaned each time the camera is turned on.
● OFF [Clean at shutdown]	The image sensor is automatically cleaned during shutdown each time the camera is turned off.
● ON OFF [Clean at startup & shutdown]	The image sensor is cleaned automatically at startup and at shutdown.
[Cleaning off]	Automatic image sensor cleaning off.

### 1 Select [Clean at startup/shutdown] for [Clean image sensor].

Pressing **▶** when [Clean at startup/shutdown] is highlighted displays [Clean at startup/shutdown] options.

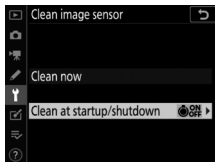

### 2 Highlight an option.

Press **OK** to select the highlighted option.

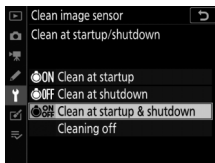

---

## ✔ Image Sensor Cleaning

- Using camera controls interrupts any image sensor cleaning begun in response to the operation of the power switch.
  - Image sensor cleaning may not fully remove all foreign matter from the filter. Clean the filter manually (📖 216) or consult a Nikon-authorized service representative.
  - If image sensor cleaning is performed several times in succession, image sensor cleaning may be temporarily disabled to protect the camera's internal circuitry. Cleaning can be performed again after a short wait.
-

## Manual Cleaning

If foreign matter cannot be removed from the low-pass filter using the “clean image sensor” option (☐ 213), the filter can be cleaned manually as described below. Note, however, that because the filter is extremely delicate and easily damaged, we recommend that manual cleaning be performed only by a Nikon-authorized service representative.

- To prevent loss of power during the operation, use a fully-charged battery or connect an optional AC adapter and power connector.
- Manual cleaning requires use of the [**Lock mirror up for cleaning**] item in the setup menu. The [**Lock mirror up for cleaning**] item is not available at battery levels of  or below or if the camera is connected to a smart device via Bluetooth or other devices via USB.

---

### 1 Turn the camera off and remove the lens.

After removing the lens, turn the camera on.

---

### 2 Highlight [**Lock mirror up for cleaning**] in the setup menu and press .

The camera will prepare to lock the mirror up.



---

### 3 Press **OK**.

- The mirror will be raised and the shutter curtain will open.
- The display in the top control panel will flash. The displays in the viewfinder and rear control panel will turn off.
- To restore normal operation without inspecting the low-pass filter, turn the camera off.

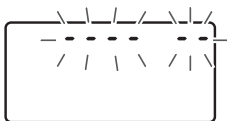

---

### 4 Holding the camera so that light can enter the camera, examine the filter for dust or lint.

If no foreign objects are present, proceed to Step 6.

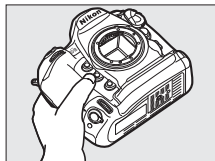

---

## 5 Remove any dust and lint from the low-pass filter with a blower.

- Do not use a blower-brush. The bristles could damage the filter.
- Dirt that cannot be removed with a blower can only be removed by Nikon-authorized service personnel. Under no circumstances should you touch or wipe the filter.

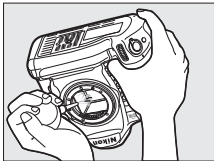

---

## 6 Turn the camera off and replace the lens.

The mirror will return to the down position and the shutter curtain will close.



---

### **✔ Use a Reliable Power Source**

The shutter curtain is delicate and easily damaged. If the camera powers off while the mirror is raised, the curtain will close automatically. To prevent damage to the curtain caused by the shutter closing inadvertently during the operation, observe the following precautions:

- Do not turn the camera off while the mirror is raised.
- Do not remove or disconnect the power source while the mirror is raised.
- If the battery runs low while the mirror is raised, a beep will sound and the self-timer lamp will flash. The shutter curtain will close and the mirror will be lowered after about two minutes; end cleaning or inspection immediately.

### **✔ Foreign Matter on the Low-Pass Filter**



Foreign matter entering the camera when lenses or body caps are removed or exchanged (or in rare circumstances lubricant or fine particles from the camera itself) may adhere to the low-pass filter, where it may appear in photographs taken under certain conditions. To prevent entry of foreign matter when attaching the body cap or exchanging lenses, avoid dusty environments and be sure to remove all dust and other foreign matter that may be adhering to the camera mount, lens mount, or body cap. To protect the camera when no lens is in place, be sure to replace the supplied body cap. Should you encounter foreign matter that cannot be removed using the image sensor cleaning option (☐ 213), clean the low-pass filter as described in “Manual Cleaning” (☐ 216), or have the filter cleaned by authorized Nikon service personnel. Photographs affected by the presence of foreign matter on the sensor can be retouched using the clean image options available in some imaging applications.

## **✔ Servicing the Camera and Accessories**

The camera is a precision device and requires regular servicing; Nikon recommends that the camera be inspected once every one to two years, and that it be serviced once every three to five years (note that fees apply to these services).

- Frequent inspection and servicing are particularly recommended if the camera is used professionally.
  - Any accessories regularly used with the camera, such as lenses or optional flash units, should be included when the camera is inspected or serviced.
-

## **Replacing the Clock Battery**

The camera clock is powered by a CR1616 lithium battery. CR1616 batteries have a life of about two years. If the  icon is displayed in the top control panel while the standby timer is on, the battery is running low and needs to be replaced. When the battery is exhausted, the  icon will flash while the standby timer is on, indicating that although photographs can still be taken, they will not be stamped with the correct time and date.

### **■ Replacing the Clock Battery**

- 1 Turn the camera off and remove the main battery.**
- 2 Slide the clock battery chamber cover, which is located on the roof of the main battery chamber, toward the front of the main battery chamber.**
- 3 Remove the clock battery.**

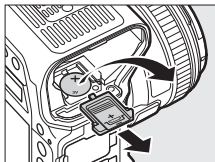

- 
- 4** Insert a new CR1616 lithium battery so that the positive side (the side marked with “+” and the battery name) is visible.

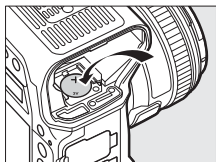

- 
- 5** Slide the clock battery chamber cover towards the back of the main battery chamber.

Stop when the cover clicks into place.

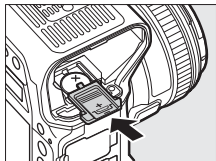

- 
- 6** Reinsert the main battery.

- 
- 7** Set the camera clock.

The **CLOCK** icon will flash in the top control panel until the clock is set.

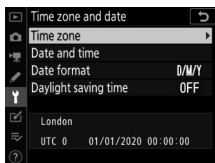

---

**✓ Inserting the Clock Battery**

Insert the clock battery in the correct orientation. Inserting the battery incorrectly could not only prevent the clock from functioning but could damage the camera.

---

# Caring for the Camera and Battery: Cautions

## Camera Care

### ● **Do Not Drop**

Do not drop the camera or lens or subject them to blows. The product may malfunction if subjected to strong shocks or vibration.

### ● **Keep Dry**

Keep the camera dry. Rusting of the internal mechanism caused by water inside the camera can not only be expensive to repair but can in fact cause irreparable damage.

### ● **Avoid Sudden Changes in Temperature**

Sudden changes in temperature, such as those that occur when entering or leaving a heated building on a cold day, can cause condensation inside the device. To prevent condensation, place the device in a carrying case or plastic bag before exposing it to sudden changes in temperature.

### ● **Keep Away from Strong Magnetic Fields**

Static charges or the magnetic fields produced by equipment such as radio transmitters could interfere with the monitor, corrupt data stored on the memory card, or affect the product's internal circuitry.

### ● **Do Not Leave the Lens Pointed at the Sun**

Do not leave the lens pointed at the sun or other strong light source for extended periods. Intense light may damage the image sensor or cause fading or “burn in”. Photographs taken with the camera may exhibit a white blur effect.

### ● **Lasers and Other Bright Light Sources**

Do not direct lasers or other extremely bright light sources toward the lens, as this could damage the camera’s image sensor.

### ● **Cleaning**

When cleaning the camera body, use a blower to gently remove dust and lint, then wipe gently with a soft, dry cloth. After using the camera at the beach or seaside, wipe off any sand or salt using a cloth lightly dampened in fresh water and then dry the camera thoroughly. In rare instances, static electricity may cause the LCD displays to light up or go dark; this does not indicate a malfunction. The display will soon return to normal.

### ● **Cleaning the Lens and Mirror**

These elements are easily damaged: remove dust and lint with a blower. If using an aerosol blower, keep the can vertical to prevent the discharge of liquid that could damage glass elements. To remove fingerprints and other stains from the lens, apply a small amount of lens cleaner to a soft cloth and wipe the lens carefully.

### ● **Cleaning the Low-Pass Filter**

For information on cleaning the low-pass filter, see “The Low-Pass Filter” (☞ 213) and “Manual Cleaning” (☞ 216).

### ● **The Lens Contacts**

Keep the lens contacts clean.

### ● **Do Not Touch the Shutter Curtain**

- The shutter curtain is extremely thin and easily damaged: under no circumstances should you exert pressure on the curtain, poke it with cleaning tools, or subject it to powerful air currents from a blower. These actions could scratch, deform, or tear the curtain.
- The shutter curtain may appear to be unevenly colored; this does not indicate a malfunction. It also has no effect on pictures.

### ● **Store in a Well-Ventilated Area**

To prevent mold or mildew, store the camera in a dry, well-ventilated area. Do not store the camera with naphtha or camphor moth balls, next to equipment that produces strong electromagnetic, or where it will be exposed to extremely high temperatures, for example near a heater or in an enclosed vehicle on a hot day. Failure to observe these precautions could result in product malfunction.

### ● **Long-Term Storage**

To prevent damage caused by, for example, leaking battery fluid, remove the battery if the product will not be used for an extended period. Store the camera in a plastic bag containing a desiccant. Do not, however, store the leather camera case in a plastic bag, as this may cause the material to deteriorate. Store the battery in a cool, dry place. Note that desiccant gradually loses its capacity to absorb moisture and should be replaced at regular intervals. To prevent mold or mildew, take the camera out of storage at least once a month, insert the battery, and release the shutter a few times.

## ● **Turn the Product Off Before Removing or Disconnecting the Power Source**

Removing or disconnecting the power source while the camera is on could damage the product. Particular care should be taken not to remove or disconnect the power source while images are being recorded or deleted.

## ● **Notes on the Monitor**

- The monitor is constructed with extremely high precision; at least 99.99% of pixels are effective, with no more than 0.01% being missing or defective. Hence while these displays may contain pixels that are always lit (white, red, blue, or green) or always off (black), this is not a malfunction. Images recorded with the device are unaffected. Your understanding is requested.
- Images in the monitor may be difficult to see in a bright light.
- Do not apply pressure to the monitor. The monitor could malfunction or suffer damage. Dust or lint on the monitor can be removed with a blower. Stains can be removed by wiping the monitor lightly with a soft cloth or chamois leather. Should the monitor break, care should be taken to avoid injury from broken glass. Be careful that liquid crystal from the monitor does not touch the skin or enter the eyes or mouth.

## ● **Dry the Accessory Shoe Cover**

If the camera is used in the rain, water may penetrate the supplied accessory shoe cover. Remove and dry the accessory shoe cover after using the camera in the rain.



## **Battery Care**

### **● Precautions for Use**

- If improperly handled, batteries may rupture or leak, causing the product to corrode. Observe the following precautions when handling batteries:
  - Turn the product off before replacing the battery.
  - Batteries may be hot after extended use.
  - Keep the battery terminals clean.
  - Use only batteries approved for use in this equipment.
  - Do not short or disassemble batteries or expose them to flame or excessive heat.
  - Replace the terminal cover when the battery is not inserted in the camera or charger.
- If the battery is hot, for example immediately after use, wait for it to cool before charging. Attempting to charge the battery while its internal temperature is elevated will impair battery performance, and the battery may not charge or charge only partially.
- If the battery will not be used for some time, insert it in the camera and run it flat before removing it from the camera for storage. The battery should be stored in a cool location with an ambient temperature of 15 °C to 25 °C (59 °F to 77 °F). Avoid hot or extremely cold locations.
- Batteries should be charged within six months of use. During long periods of disuse, charge the battery and use the camera to run it flat once every six months before returning it to a cool location for storage.
- Remove the battery from the camera or charger when not in use. The camera and charger draw minute amounts of charge even when off and could draw the battery down to the point that it will no longer function.

- Do not use the battery at ambient temperatures below 0 °C (32 °F) or above 40 °C (104 °F). Failure to observe this precaution could damage the battery or impair its performance. Charge the battery indoors at ambient temperatures of 5 °C–35 °C (41 °F–95 °F). The battery will not charge if its temperature is below 0 °C (32 °F) or above 60 °C (140 °F).
- Capacity may be reduced and charging times increase at battery temperatures from 0 °C (32 °F) to 15 °C (59 °F) and from 45 °C (113 °F) to 60 °C (140 °F).
- Batteries in general exhibit a drop in capacity at low ambient temperatures. Even fresh batteries charged at temperatures under about 5 °C (41 °F) may show a temporary increase from “0” to “1” in the setup menu [**Battery info**] age display, but the display will return to normal once the battery has been recharged at a temperature of about 20 °C (68 °F) or higher.
- Battery capacity drops at low temperatures. The change in capacity with temperature is reflected in the camera battery-level display. As a result, the battery display may show a drop in capacity as the temperature drops, even if the battery is fully charged.
- Batteries may be hot after use. Observe due caution when removing batteries from the camera.

### ● **Charge Batteries Before Use**

Charge the battery before use. The supplied battery is not fully charged at shipment.

### ● **Ready Spare Batteries**

Before taking photographs, ready a spare battery and keep it fully charged. Depending on your location, it may be difficult to purchase replacement batteries on short notice.

### ● **Have Fully-Charged Spare Batteries Ready on Cold Days**

Partially-charged batteries may not function on cold days. In cold weather, charge one battery before use and keep another in a warm place, ready to be exchanged as necessary. Once warmed, a cold battery may recover some of its charge.

### ● **Battery Level**

- Turning the camera on or off repeatedly when the battery is fully discharged will shorten battery life. Batteries that have been fully discharged must be charged before use.
- A marked drop in the time a fully charged battery retains its charge when used at room temperature indicates that it requires replacement. Purchase a new rechargeable battery.

### ● **Do Not Attempt to Charge Fully-Charged Batteries**

Continuing to charge the battery after it is fully charged can impair battery performance.

### ● **Recycling Used Batteries**

Recycle rechargeable batteries in accord with local regulations, being sure to first insulate the terminals with tape.

## **Using the Charger**

- Do not short the charger terminals. Failure to observe this precaution could result in overheating and damage to the charger.
- Unplug the charger when it is not in use.
- Use the MH-26a with compatible batteries only.
- Do not use chargers with damage that leaves the interior exposed or that produce unusual sounds when used.

# Exposure Program

The following graph shows the exposure program for mode **P** (ISO 100, maximum lens aperture f/1.4):

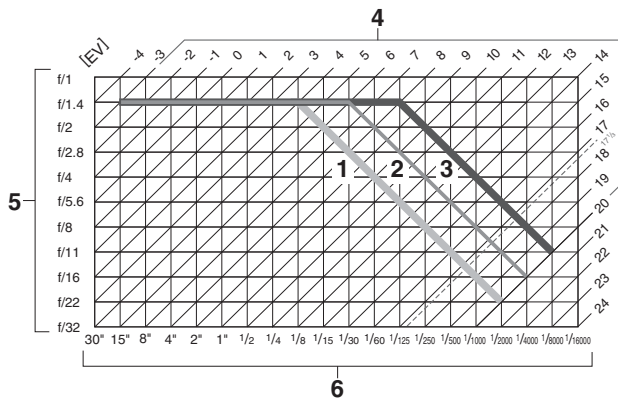

**1** F (lens focal length)  $\leq$  55 mm

**2** 55 mm  $<$  F  $\leq$  135 mm

**3** 135 mm  $<$  F

**4** Metering range: -3 to 20 EV

**5** Aperture

**6** Seconds (shutter speed)

- The maximum and minimum values for EV vary with the metering range.
- When matrix metering is used, values over  $17 \frac{1}{3}$  EV are reduced to  $17 \frac{1}{3}$  EV.

# Specifications

## Nikon D6 Digital Camera

Type	
Type	Single-lens reflex digital camera
Lens mount	Nikon F mount (with AF coupling and AF contacts)
Effective angle of view	Nikon FX format
Effective pixels	
Effective pixels	20.8 million
Image sensor	
Type	35.9 × 23.9 mm CMOS sensor
Total pixels	21.33 million
Dust-reduction system	Image sensor cleaning, Image Dust Off reference data (requires NX Studio)

Image size  
(pixels)

- **[FX (36 × 24)] selected for image area:**
  - 5568 × 3712 (Large: 20.7 M)
  - 4176 × 2784 (Medium: 11.6 M)
  - 2784 × 1856 (Small: 5.2 M)
- **[1.2 × (30 × 20)] selected for image area:**
  - 4640 × 3088 (Large: 14.3 M)
  - 3472 × 2312 (Medium: 8.0 M)
  - 2320 × 1544 (Small: 3.6 M)
- **[DX (24 × 16)] selected for image area:**
  - 3648 × 2432 (Large: 8.9 M)
  - 2736 × 1824 (Medium: 5.0 M)
  - 1824 × 1216 (Small: 2.2 M)
- **[5:4 (30 × 24)] selected for image area:**
  - 4640 × 3712 (Large: 17.2 M)
  - 3472 × 2784 (Medium: 9.7 M)
  - 2320 × 1856 (Small: 4.3 M)
- **[1:1 (24 × 24)] selected for image area:**
  - 3712 × 3712 (Large: 13.8 M)
  - 2784 × 2784 (Medium: 7.8 M)
  - 1856 × 1856 (Small: 3.4 M)
- **[16:9 (36 × 20)] selected for image area:**
  - 5568 × 3128 (Large: 17.4 M)
  - 4176 × 2344 (Medium: 9.8 M)
  - 2784 × 1560 (Small: 4.3 M)
- **Photographs taken while filming movies at a frame size of 3840 × 2160:** 3840 × 2160
- **Photographs taken while filming movies at a frame size of 1920 × 1080:** 1920 × 1080
- **Photographs taken while filming movies at a frame size of 1280 × 720:** 1280 × 720

## Storage

<b>File format (image quality)</b>	<ul style="list-style-type: none"><li>• <b>NEF (RAW):</b> 12 or 14 bit (lossless compressed, compressed, or uncompressed); large, medium, and small available (medium and small images are recorded at a bit depth of 12 bits using lossless compression)</li><li>• <b>JPEG:</b> JPEG-Baseline compliant with fine (approx. 1:4), normal (approx. 1:8), or basic (approx. 1:16) compression; size-priority and optimal-quality compression available</li><li>• <b>NEF (RAW)+JPEG:</b> Single photograph recorded in both NEF (RAW) and JPEG formats</li></ul>
<b>Picture Control System</b>	Auto, Standard, Neutral, Vivid, Monochrome, Portrait, Landscape, Flat, Creative Picture Controls (Dream, Morning, Pop, Sunday, Somber, Dramatic, Silence, Bleached, Melancholic, Pure, Denim, Toy, Sepia, Blue, Red, Pink, Charcoal, Graphite, Binary, Carbon); selected Picture Control can be modified; storage for custom Picture Controls
<b>Media</b>	CFexpress (Type B) and XQD memory cards
<b>Double card slots</b>	The card in Slot 2 can be used for overflow or backup storage, for separate storage of NEF (RAW) and JPEG copies of photos taken at image quality settings of NEF (RAW) + JPEG, or to store separate copies of JPEG photos at different sizes and compression ratios; pictures can be copied between cards
<b>File system</b>	DCF 2.0, Exif 2.31



<b>Viewfinder</b>	
<b>Viewfinder</b>	Eye-level pentaprism single-lens reflex viewfinder
<b>Frame coverage</b>	<ul style="list-style-type: none"> <li>• <b>FX</b>: Approx. 100% horizontal and 100% vertical</li> <li>• <b>1.2x</b>: Approx. 97% horizontal and 97% vertical</li> <li>• <b>DX</b>: Approx. 97% horizontal and 97% vertical</li> <li>• <b>5:4</b>: Approx. 97% horizontal and 100% vertical</li> <li>• <b>1:1</b>: Approx. 95% horizontal and 100% vertical</li> <li>• <b>16:9</b>: Approx. 100% horizontal and 96% vertical</li> </ul>
<b>Magnification</b>	Approx. 0.72× (50 mm f/1.4 lens at infinity, $-1.0\text{ m}^{-1}$ )
<b>Eyepoint</b>	17 mm ( $-1.0\text{ m}^{-1}$ ; from center surface of viewfinder eyepiece lens)
<b>Diopter adjustment</b>	$-3$ – $+1\text{ m}^{-1}$
<b>Focusing screen</b>	Type B BriteView Clear Matte Mark X screen (with AF-area brackets; framing grid can be displayed)
<b>Reflex mirror</b>	Quick return
<b>Depth-of-field preview</b>	Pressing <b>Pv</b> button stops lens aperture down to value selected by user ( <b>A</b> and <b>M</b> modes) or by camera ( <b>P</b> and <b>S</b> modes)
<b>Lens aperture</b>	Instant return, electronically controlled

Lens	
<b>Compatible lenses</b>	<ul style="list-style-type: none"> <li>• <b>Types G, E, and D</b> (some restrictions apply to PC lenses)</li> <li>• <b>Other AF NIKKOR lenses</b> (excluding IX NIKKOR lenses and lenses for the F3AF)</li> <li>• <b>AI-P NIKKOR lenses</b></li> <li>• <b>DX lenses</b> (using [DX (24 × 16)] image area)</li> <li>• <b>Non-CPU AI lenses</b> (modes <b>A</b> and <b>M</b> only)</li> <li>• During viewfinder photography, the electronic rangefinder can be used with lenses that have a maximum aperture of f/5.6 or faster. With lenses that have a maximum aperture of f/8 or faster, the electronic rangefinder supports 15 focus points.</li> </ul>

Shutter	
<b>Type</b>	Electronically-controlled vertical-travel focal-plane mechanical shutter; electronic front-curtain shutter; electronic shutter
<b>Speed</b>	1/8000–30 s (choose from step sizes of 1/3, 1/2, and 1 EV, extendable to 900 s in mode <b>M</b> ), Bulb; Time; X250
<b>Flash sync speed</b>	X=1/250 s; synchronizes with shutter at 1/250 s or slower <ul style="list-style-type: none"> <li>• Auto FP high-speed sync supported</li> </ul>

Release	
<b>Release mode</b>	<b>S</b> (single frame), <b>CL</b> (continuous low speed), <b>CH</b> (continuous high speed), <b>Q</b> (quiet shutter-release),  (self-timer), <b>MUP</b> (mirror up)
<b>Approximate frame advance rate</b>	<ul style="list-style-type: none"> <li>• <b>CL</b>: 1–10 fps</li> <li>• <b>CH</b>: 10–14 fps</li> <li>• <b>Q</b>: 1–5 fps</li> </ul>
<b>Self-timer</b>	2 s, 5 s, 10 s, 20 s; 1–9 exposures at intervals of 0.5, 1, 2, or 3 s
Exposure	
<b>Metering system</b>	<ul style="list-style-type: none"> <li>• <b>Viewfinder photography</b>: TTL exposure metering using RGB sensor with approximately 180K (180,000) pixels</li> <li>• <b>Live view</b>: TTL exposure metering performed by image sensor</li> </ul>

Exposure	
<b>Metering mode</b>	<ul style="list-style-type: none"> <li>• <b>Matrix:</b> 3D color matrix metering III (type G, E, and D lenses); color matrix metering III (other CPU lenses); color matrix metering available with non-CPU lenses if user provides lens data</li> <li>• <b>Center-weighted:</b> Weight of 75% given to 12 mm circle in center of frame; diameter of circle can be changed to 8, 15, or 20 mm, or weighting can be based on average of entire frame (non-CPU and AF-S Fisheye NIKKOR 8–15mm f/3.5–4.5E ED lenses use 12-mm circle)</li> <li>• <b>Spot:</b> Meters circle approximately 4 mm in diameter (about 1.5% of frame) centered on selected focus point (on center focus point when non-CPU or AF-S Fisheye NIKKOR 8–15mm f/3.5–4.5E ED lens is used)</li> <li>• <b>Highlight-weighted:</b> Available with type G, E, and D lenses</li> </ul>
<b>Range *</b>	<ul style="list-style-type: none"> <li>• <b>Matrix or center-weighted metering:</b> –3–+20 EV</li> <li>• <b>Spot metering:</b> 2–20 EV</li> <li>• <b>Highlight-weighted metering:</b> 0–20 EV</li> </ul> <p>* Figures are for ISO 100 and f/1.4 lens at 20 °C/68 °F</p>
<b>Exposure meter coupling</b>	Combined CPU and AI



Exposure	
<b>Mode</b>	<b>P</b> (programmed auto with flexible program); <b>S</b> (shutter-priority auto); <b>A</b> (aperture-priority auto); <b>M</b> (manual)
<b>Exposure compensation</b>	-5 – +5 EV; -3 – +3 EV when filming movies (choose from step sizes of 1/3, 1/2, and 1 EV)
<b>Exposure lock</b>	Luminosity locked at detected value
<b>ISO sensitivity (Recommended Exposure Index)</b>	ISO 100–102400 (choose from step sizes of 1/3, 1/2, and 1 EV); can also be set to approx. 0.3, 0.5, 0.7, or 1 EV (ISO 50 equivalent) below ISO 100 or to approx. 0.3, 0.5, 0.7, 1, 2, 3, 4, or 5 EV (ISO 3280000 equivalent) above ISO 102400; auto ISO sensitivity control available
<b>Active D-Lighting</b>	Can be selected from Auto, Extra high +2, Extra high +1, High, Normal, Low, and Off

Autofocus	
<b>Type</b>	<ul style="list-style-type: none"> <li>• <b>Viewfinder photography:</b> TTL phase-detection; 105 focus points, all of which are cross-type sensors and 15 of which support f/8; detection performed by Multi-CAM 37K autofocus sensor module; autofocus fine-tuning supported</li> <li>• <b>Live view:</b> Contrast-detect AF available at all points in frame; focus point selected by camera when face detection or subject-tracking is used</li> </ul>

<b>Autofocus</b>	
<b>Detection range</b>	-4.5 – +20 EV (ISO 100, 20 °C/68 °F)
<b>Lens servo</b>	<ul style="list-style-type: none"> <li>• <b>Autofocus (AF):</b> Single-servo AF (<b>AF-S</b>); continuous-servo AF (<b>AF-C</b>, viewfinder photography only; predictive focus tracking activated automatically according to subject status); full-time AF (<b>AF-F</b>; available only during live view and movie recording)</li> <li>• <b>Manual focus (M):</b> Electronic rangefinder can be used</li> </ul>
<b>Focus points</b>	105 focus points (number available for selection in viewfinder photography can be chosen from 105, 27, and 15)
<b>AF-area mode</b>	<ul style="list-style-type: none"> <li>• <b>Viewfinder photography:</b> Single-point AF; 9-, 25-, 49-, or 105- point dynamic-area AF; 3D-tracking; group-area AF; group-area AF (C1); group-area AF (C2); auto-area AF</li> <li>• <b>Live view:</b> Face-detection AF, wide-area AF, normal-area AF, subject-tracking AF</li> </ul>
<b>Focus lock</b>	Focus can be locked by pressing shutter-release button halfway (single-servo AF/ <b>AF-S</b> ) or by pressing the center of the sub-selector

**Flash**

<b>Flash control</b>	<b>TTL flash control using RGB sensor with approximately 180K (180,000) pixels:</b> i-TTL flash control; i-TTL balanced fill-flash for digital SLR is used with matrix, center-weighted, and highlight-weighted metering, standard i-TTL fill-flash for digital SLR with spot metering
<b>Flash mode</b>	Front-curtain sync, red-eye reduction, slow sync, red-eye reduction with slow sync, rear-curtain sync, off
<b>Flash compensation</b>	-3 – +1 EV (choose from step sizes of $\frac{1}{3}$ , $\frac{1}{2}$ and 1 EV)
<b>Flash-ready indicator</b>	Lights when optional flash unit is fully charged; flashes after flash is fired at full output
<b>Accessory shoe</b>	ISO 518 hot-shoe with sync and data contacts and safety lock
<b>Nikon Creative Lighting System (CLS)</b>	i-TTL flash control, radio-controlled Advanced Wireless Lighting, optical Advanced Wireless Lighting, modeling illumination, FV lock, Color Information Communication, auto FP high-speed sync, AF-assist for multi-area AF (viewfinder photography), unified flash control
<b>Sync terminal</b>	ISO 519 sync terminal with locking thread

<b>White balance</b>	
<b>White balance</b>	Auto (3 types), natural light auto, direct sunlight, cloudy, shade, incandescent, fluorescent (7 types), flash, choose color temperature (2500 K–10,000 K), preset manual (up to 6 values can be stored, spot white balance measurement available during live view), all with fine-tuning
<b>Bracketing</b>	
<b>Bracketing</b>	Exposure and/or flash, white balance, and ADL
<b>Live view</b>	
<b>Mode</b>	 (photo live view),  (movie live view)
<b>Movie</b>	
<b>Metering system</b>	TTL metering using camera image sensor
<b>Metering mode</b>	Matrix, center-weighted, or highlight-weighted



Movie	
<b>Frame size (pixels) and frame rate</b>	<ul style="list-style-type: none"> <li>• 3840 × 2160 (4K UHD): 30p (progressive), 25p, 24p</li> <li>• 1920 × 1080: 60p, 50p, 30p, 25p, 24p</li> <li>• 1280 × 720: 60p, 50p</li> <li>• 1920 × 1080 crop: 60p, 50p, 30p, 25p, 24p</li> <li>* Actual frame rates for 60p, 50p, 30p, 25p, and 24p are 59.94, 50, 29.97, 25, and 23.976 fps respectively</li> <li>* Quality selection available at all sizes except 3840 × 2160, when quality is fixed at ★ (high)</li> </ul>
<b>File format</b>	MOV, MP4
<b>Video compression</b>	H.264/MPEG-4 Advanced Video Coding
<b>Audio recording format</b>	Linear PCM (for movies recorded in MOV format) or AAC (for movies recorded in MP4 format)
<b>Audio recording device</b>	Built-in stereo or external microphone with attenuator option; sensitivity adjustable
<b>ISO sensitivity (Recommended Exposure Index)</b>	<ul style="list-style-type: none"> <li>• <b>Mode M:</b> Manual selection (ISO 100 to 102400; choose from step sizes of <math>\frac{1}{3}</math>, <math>\frac{1}{2}</math>, and 1 EV) with additional options available equivalent to approximately 0.3, 0.5, 0.7, 1, 2, 3, 4, or 5 EV (ISO 3280000 equivalent) above ISO 102400; auto ISO sensitivity control (ISO 100 to Hi 5) available with selectable upper limit</li> <li>• <b>Modes P, S, and A:</b> Auto ISO sensitivity control (ISO 100 to Hi 5) with selectable upper limit</li> </ul>

<b>Movie</b>	
<b>Active D-Lighting</b>	Can be selected from Extra high, High, Normal, Low, and Off
<b>Other options</b>	Time-lapse movie recording, electronic vibration reduction, time codes
<b>Monitor</b>	
<b>Monitor</b>	8-cm/3.2-in., approx. 2359k-dot (XGA) TFT touch-sensitive LCD with 170 ° viewing angle, approximately 100% frame coverage, 11-level manual brightness adjustment, and color balance control
<b>Playback</b>	
<b>Playback</b>	Full-frame and thumbnail (4, 9, or 72 images) playback with playback zoom, playback zoom cropping, movie playback, photo and/or movie slide shows, histogram display, highlights, photo information, location data display, picture rating, auto image rotation, index marking, voice memo input and playback, and IPTC information embedding and display

Interface	
<b>USB</b>	Type C USB connector (SuperSpeed USB); connection to built-in USB port is recommended
<b>HDMI output</b>	Type C HDMI connector
<b>Audio input</b>	Stereo mini-pin jack (3.5 mm diameter; plug-in power supported)
<b>Audio output</b>	Stereo mini-pin jack (3.5 mm diameter)
<b>Ten-pin remote terminal</b>	Built-in (can be used with MC-30A/MC-36A remote cords and other optional accessories)
<b>Ethernet</b>	<p>RJ-45 connector</p> <ul style="list-style-type: none"> <li>• <b>Standards:</b> IEEE 802.3ab (1000BASE-T)/IEEE 802.3u (100BASE-TX)/IEEE 802.3 (10BASE-T)</li> <li>• <b>Data rates</b> *: 10/100/1000 Mbps with auto detect</li> <li>• <b>Port:</b> 1000BASE-T/100BASE-TX/10BASE-T (AUTO-MDIX)</li> </ul> <p>* Maximum logical data rates according to IEEE standard; actual rates may differ.</p>
<b>Peripheral connector</b>	For WT-6

**Wi-Fi**

- **Standards:**
  - IEEE 802.11b/g/n (Africa, Asia, and Oceania)
  - IEEE 802.11b/g/n/a/ac (Europe, U.S.A., Canada, Mexico)
  - IEEE 802.11b/g/n/a (other countries in the Americas)
- **Operating frequency:**
  - 2412–2462 MHz (channel 11; Africa, Asia, and Oceania)
  - 2412–2462 MHz (channel 11) and 5180–5825 MHz (U.S.A., Canada, Mexico)
  - 2412–2462 MHz (channel 11) and 5180–5805 MHz (other countries in the Americas)
  - 2412–2462 MHz (channel 11) and 5745–5805 MHz (Georgia)
  - 2412–2462 MHz (channel 11) and 5180–5320 MHz (other European countries)
- **Maximum output power (EIRP):**
  - 2.4 GHz band: 6.8 dBm
  - 5 GHz band: 6.3 dBm (Georgia)
  - 5 GHz band: 9.3 dBm (other countries)
- **Authentication:** Open system, WPA2-PSK

## Wi-Fi/Bluetooth

<b>Bluetooth</b>	<ul style="list-style-type: none"><li>• <b>Communication protocols:</b> Bluetooth Specification Version 4.2</li><li>• <b>Operating frequency:</b><ul style="list-style-type: none"><li>- Bluetooth: 2402–2480 MHz</li><li>- Bluetooth Low Energy: 2402–2480 MHz</li></ul></li><li>• <b>Maximum output power (EIRP):</b><ul style="list-style-type: none"><li>- Bluetooth: 1.3 dBm</li><li>- Bluetooth Low Energy: –0.2 dBm</li></ul></li></ul>
<b>Range (line of sight)</b>	Approximately 10 m (32 ft) * * Without interference. Range may vary with signal strength and presence or absence of obstacles.

## Location data

<b>Supported GNS systems</b>	GPS (USA), GLONASS (Russia), QZSS (Japan)
<b>Data acquired</b>	Latitude, longitude, altitude, UTC (Universal Coordinated Time)
<b>Clock synchronization</b>	Camera clock can be set to time acquired via GNSS
<b>Track logs</b>	NMEA-compliant
<b>Log interval</b>	15 s, 30 s, 1 min., 2 min., 5 min.

<b>Location data</b>	
<b>Maximum log recording time</b>	6, 12, or 24 hours
<b>Log deletion</b>	Supported
<b>Power source</b>	
<b>Battery</b>	One EN-EL18c rechargeable Li-ion battery * * EN-EL18b/EN-EL18a/EN-EL18 batteries can also be used. Note, however, that fewer pictures can be taken on a single charge with an EN-EL18 than with an EN-EL18c/EN-EL18b/EN-EL18a.
<b>AC adapter</b>	EH-6c AC adapter; requires EP-6 power connector (available separately)
<b>Tripod socket</b>	
<b>Tripod socket</b>	1/4 in. (ISO 1222)
<b>Dimensions/weight</b>	
<b>Dimensions (W×H×D)</b>	Approx. 160 × 163 × 92 mm (6.3 × 6.5 × 3.7 in.)
<b>Weight</b>	Approx. 1450 g (3 lb. 3.2 oz.) with battery and two CFexpress memory cards but without body cap and accessory shoe cover; approx. 1270 g/2 lb. 12.8 oz. (camera body only)

## Operating environment

<b>Temperature</b>	0 °C–40 °C (+32 °F–104 °F)
<b>Humidity</b>	85% or less (no condensation)

- Unless otherwise stated, all measurements are performed in conformity with Camera and Imaging Products Association (CIPA) standards or guidelines.
- All figures are for a camera with a fully-charged battery.
- The sample images displayed on the camera and the images and illustrations in the manuals are for expository purposes only.
- Nikon reserves the right to change the appearance and specifications of the hardware and software described in this manual at any time and without prior notice. Nikon will not be held liable for damages that may result from any mistakes that this manual may contain.

## ■ MH-26a Battery Charger

<b>Rated input</b>	AC 100 to 240 V, 50/60 Hz
<b>Rated output</b>	DC 12.6 V/1.2 A
<b>Supported batteries</b>	Nikon EN-EL18c/EN-EL18b/EN-EL18a/EN-EL18 rechargeable Li-ion batteries
<b>Charging time per battery</b>	Approx. 2 hours and 35 minutes * Time required to charge battery at an ambient temperature of 25 °C (77 °F) when no charge remains
<b>Operating temperature</b>	0 °C–40 °C (+32 °F–104 °F)
<b>Dimensions (W × H × D)</b>	Approx. 160 × 85 × 50.5 mm (6.3 × 3.3 × 2 in.)
<b>Length of power cable</b>	Approx. 1.8 m/6 ft (U.S.A. and Canada) or 1.5 m/4.9 ft (other countries)
<b>Weight</b>	Approx. 285 g (10.1 oz), including two contact protectors but excluding power cable; approx. 265 g (9.3 oz), excluding both contact protectors and power cable

The symbols on this product represent the following:

~ AC, ≡ DC, □ Class II equipment (the construction of the product is double-insulated)



## ■ EN-EL18c Rechargeable Li-ion Battery

<b>Type</b>	Rechargeable lithium-ion battery
<b>Rated capacity</b>	10.8 V/2500 mAh
<b>Operating temperature</b>	0 °C–40 °C (+32 °F–104 °F)
<b>Dimensions (W× H × D)</b>	Approx. 56.5 × 27 × 82.5 mm (2.2 × 1.1 × 3.2 in.)
<b>Weight</b>	Approx. 160 g (5.6 oz), excluding terminal cover

## Calibrating Batteries

The MH-26a battery charger can detect whether batteries require calibration and calibrate them as necessary to ensure the accuracy of the battery level display. Calibration status and progress are shown by lamps on the battery charger:

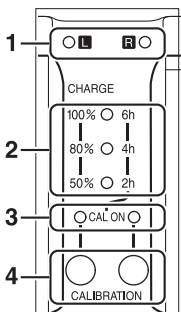

- 1 Chamber lamps (green)
- 2 Charge lamps (green)
- 3 Calibration lamps (yellow)
- 4 Calibration buttons

If the calibration lamp for the current battery chamber flashes when a battery is inserted, the battery needs to be calibrated.

To begin calibration, press the calibration button for the current chamber for about a second. The chamber lamp for the current battery chamber flashes while calibration is in progress.

The display can be read as follows:

		Approximate time needed to recalibrate battery			
		Under 2 hours	2–4 hours	4–6 hours	Over 6 hours
Charge lamps (green)	2h	● (off)	○ (on)	○ (on)	○ (on)
	4h	● (off)	● (off)	○ (on)	○ (on)
	6h	● (off)	● (off)	● (off)	○ (on)
Calibration (CAL ON) lamp (yellow): L/R		○ (on)	○ (on)	○ (on)	○ (on)

Although calibration is recommended for accurate measurement of battery charge state, calibration need not be performed when the calibration lamp flashes. Once begun, calibration can be interrupted as desired.

- If the calibration button is not pressed while the calibration lamp is flashing, normal charging will begin after about ten seconds.
- To interrupt calibration, press the calibration button again. Calibration will end and charging will begin.

When calibration is complete, the calibration and charge lamps will turn off and charging will begin immediately.

---

### ☑ Warning Indicators

- **If the “L” and “R” chamber and calibration lamps flash on and off in sequence when no battery is inserted...**

...there is a problem with the charger. Unplug the charger and consult a Nikon-authorized service representative.

- **If the “L” and “R” chamber and calibration lamps flash on and off in sequence when a battery is inserted...**

...a problem has occurred with the battery or charger during charging. Remove the battery, unplug the charger, and consult a Nikon-authorized service representative.

---

### ☑ Charging and Calibrating Two Batteries

If batteries are inserted in both chambers, they will be charged in the order inserted. If a calibration button is pressed when either calibration lamp is flashing, the charger will calibrate and then charge whichever of the batteries was the first to be inserted. The second battery cannot be calibrated or charged until the process is complete.

---

---

## ✔ Disposing of Data Storage Devices

Please note that deleting images or formatting memory cards or other data storage devices does not completely erase the original image data. Deleted files can sometimes be recovered from discarded storage devices using commercially available software, potentially resulting in the malicious use of personal image data. Ensuring the privacy of such data is the user's responsibility.

Before discarding a data storage device or transferring ownership to another person, erase all data using commercial deletion software, or format the device and then completely refill it with images containing no private information (for example, pictures of empty sky). Care should be taken to avoid injury when physically destroying data storage devices. Before discarding the camera or transferring ownership to another person, you should also use the **[Reset all settings]** item in the camera setup menu to delete network settings and other personal information.

## ☑ Supported Standards

- **DCF Version 2.0:** The Design Rule for Camera File System (DCF) is a standard widely used in the digital camera industry to ensure compatibility among different makes of camera.
  - **Exif version 2.31:** The camera supports Exif (Exchangeable Image File Format for Digital Still Cameras) version 2.31, a standard introduced with the goal of improving the interoperability of printers and digital cameras, making it easier to produce high-quality prints. Information stored with photographs is used for optimal color reproduction when the images are output on Exif-compliant printers. See the printer manual for details.
  - **HDMI:** High-Definition Multimedia Interface is a standard for multimedia interfaces used in consumer electronics and AV devices. This standard ensures that audiovisual data and control signals can be transmitted to HDMI-compliant devices via a single cable connection.
-

## Approved Memory Cards

- The camera can be used with CFexpress (Type B) and XQD memory cards.
- Cards with write speeds of 45 MB/s (300×) or better are recommended for movie recording and playback. Slower speeds may result in recording being interrupted. Playback may also be interrupted or jerky when movies are viewed on the camera.
- Contact the manufacturer for information on features, operation, and limitations on use.

## Memory Card Capacity

The following table shows the approximate number of pictures that can be stored on a 128 GB <sup>1</sup> card at different image area, image quality, and image size settings. Actual capacity varies with shooting conditions and the type of card.

### **[FX (36 × 24)] Selected for Image Area**

This category also includes images taken with non-DX lenses when [On] is selected for [Image area] > [Auto DX crop].

Image quality	Image size	File size	Number of exposures remaining <sup>2</sup>	Buffer capacity <sup>2, 3</sup>
<b>NEF (RAW), Lossless compressed, 12-bit</b>	Large	Approx. 20.2 MB	3500 frames	184 frames
	Medium	Approx. 14.6 MB	4700 frames	79 frames
	Small	Approx. 11.1 MB	6200 frames	84 frames
<b>NEF (RAW), Lossless compressed, 14-bit</b>	Large	Approx. 25.1 MB	3000 frames	146 frames
<b>NEF (RAW), Compressed, 12-bit</b>	Large	Approx. 18.4 MB	4700 frames	186 frames
<b>NEF (RAW), Compressed, 14-bit</b>	Large	Approx. 22.6 MB	3900 frames	152 frames



<b>Image quality</b>	<b>Image size</b>	<b>File size</b>	<b>Number of exposures remaining <sup>2</sup></b>	<b>Buffer capacity <sup>2, 3</sup></b>
<b>NEF (RAW), Uncompressed, 12-bit</b>	Large	Approx. 33.1 MB	3500 frames	133 frames
<b>NEF (RAW), Uncompressed, 14-bit</b>	Large	Approx. 38.0 MB	3000 frames	105 frames
<b>JPEG fine <sup>4</sup></b>	Large	Approx. 10.8 MB	8400 frames	200 frames
	Medium	Approx. 6.9 MB	13,900 frames	200 frames
	Small	Approx. 3.8 MB	25,600 frames	200 frames
<b>JPEG normal <sup>4</sup></b>	Large	Approx. 5.7 MB	16,500 frames	200 frames
	Medium	Approx. 3.5 MB	27,000 frames	200 frames
	Small	Approx. 2.0 MB	48,700 frames	200 frames
<b>JPEG basic <sup>4</sup></b>	Large	Approx. 2.6 MB	31,400 frames	200 frames
	Medium	Approx. 1.8 MB	51,300 frames	200 frames
	Small	Approx. 1.1 MB	88,600 frames	200 frames

## **[DX (24 × 16)] Selected for Image Area**

This category also includes images taken with DX lenses when **[On]** is selected for **[Image area] > [Auto DX crop]**.

<b>Image quality</b>	<b>Image size</b>	<b>File size</b>	<b>Number of exposures remaining <sup>2</sup></b>	<b>Buffer capacity <sup>2, 3</sup></b>
<b>NEF (RAW), Lossless compressed, 12-bit</b>	Large	Approx. 9.8 MB	7600 frames	200 frames
	Medium	Approx. 7.2 MB	10,100 frames	129 frames
	Small	Approx. 5.6 MB	13,000 frames	142 frames
<b>NEF (RAW), Lossless compressed, 14-bit</b>	Large	Approx. 11.9 MB	6700 frames	200 frames
<b>NEF (RAW), Compressed, 12-bit</b>	Large	Approx. 9.0 MB	10,000 frames	200 frames
<b>NEF (RAW), Compressed, 14-bit</b>	Large	Approx. 10.8 MB	8500 frames	200 frames
<b>NEF (RAW), Uncompressed, 12-bit</b>	Large	Approx. 15.1 MB	7600 frames	200 frames
<b>NEF (RAW), Uncompressed, 14-bit</b>	Large	Approx. 17.2 MB	6700 frames	200 frames

<b>Image quality</b>	<b>Image size</b>	<b>File size</b>	<b>Number of exposures remaining <sup>2</sup></b>	<b>Buffer capacity <sup>2, 3</sup></b>
<b>JPEG fine <sup>4</sup></b>	Large	Approx. 5.6 MB	17,400 frames	200 frames
	Medium	Approx. 3.7 MB	26,300 frames	200 frames
	Small	Approx. 2.3 MB	42,400 frames	200 frames
<b>JPEG normal <sup>4</sup></b>	Large	Approx. 2.9 MB	33,600 frames	200 frames
	Medium	Approx. 2.0 MB	48,700 frames	200 frames
	Small	Approx. 1.3 MB	75,000 frames	200 frames
<b>JPEG basic <sup>4</sup></b>	Large	Approx. 1.6 MB	60,900 frames	200 frames
	Medium	Approx. 1.1 MB	88,600 frames	200 frames
	Small	Approx. 0.8 MB	121,000 frames	200 frames

- 1 Figures are for a Sony CEB-G128 128 GB CFexpress memory card (as of December 2019).
- 2 Number of pictures that can be saved to memory card or stored in memory buffer varies with scene recorded.
- 3 Maximum number of exposures that can be stored in memory buffer at ISO 100. May drop in some situations, including when:
  - An optimal-compression (★) JPEG option is selected for **[Image quality]**
  - **[On]** is selected for **[Auto distortion control]**
- 4 Figures assume a size-priority option (an option not marked with ★) is selected for **[Image quality]**. Selecting an optimal-compression (★) option increases file size; the number of images and buffer capacity drop accordingly.

---

### **☑ Maximum Number of Photo per Burst**

The maximum number of photographs that can be taken in a single burst can be set to any amount between 1 and 200 using Custom Setting d2 **[Max. continuous release]**.

---

## Battery Endurance

The movie footage or number of shots that can be recorded with a fully-charged EN-EL18c (2500 mAh) rechargeable Li-ion battery <sup>1</sup> is given below. Actual endurance varies with such factors as the condition of the battery, the interval between shots, and the options selected in the camera menus.

- Photographs, single-frame release mode: Approximately 3580 (CIPA standard <sup>2</sup>)
- Photographs, continuous release modes: Approximately 8670 (Nikon standard <sup>3</sup>)
- Movies: Approximately 105 minutes <sup>4</sup>

Actions such as the following can reduce battery endurance:

- Using the monitor, for example for live view photography
- Keeping the shutter-release button pressed halfway
- Repeated autofocus operations
- Taking NEF (RAW) photographs
- Slow shutter speeds

- Using camera Ethernet, Wi-Fi (wireless LAN), and Bluetooth features
- Using the built-in GNSS receiver
- Using the camera with optional accessories connected
- Using VR (vibration reduction) with VR lenses
- Repeatedly zooming in and out with AF-P lenses

To ensure that you get the most from rechargeable Nikon EN-EL18c batteries:

- Keep the battery contacts clean. Soiled contacts can reduce battery performance.
- Use batteries immediately after charging. Batteries will lose their charge if left unused.
- Check the condition of the battery regularly using the **[Battery info]** option in the setup menu. If a  CAL icon appears in the **[Calibration]** field, calibrate the battery in the MH-26a battery charger (📖 252). If the battery has not been used for more than six months, recharge the battery when calibration is complete.

- 1 EN-EL18b/EN-EL18a/EN-EL18 batteries can also be used. Note, however, that the EN-EL18 can take fewer pictures on a single charge than the EN-EL18c/EN-EL18b/EN-EL18a.
- 2 Lens cycled from infinity to minimum range and one photograph taken at default settings once every 30 s. Live view not used. Measured at 23 °C/73.4 °F ( $\pm 2$  °C/3.6 °F) with an AF-S NIKKOR 24–70mm f/2.8E ED VR lens.
- 3 Image quality set to JPEG normal, image size set to large, shutter speed  $\frac{1}{250}$  s, focus cycled from infinity to minimum range three times after shutter-release button has been pressed halfway for 3 s; six shots are then taken in succession and monitor turned on for 5 s and then turned off; no operations performed until stand-by timer has expired. The cycle is then repeated. Measured at 23 °C/73.4 °F ( $\pm 2$  °C/3.6 °F) with an AF-S NIKKOR 70–200mm f/2.8E FL ED VR lens (VR off).
- 4 Actual battery endurance as measured under conditions specified by the Camera and Imaging Products Association (CIPA). Measured at 23 °C/73.4 °F ( $\pm 2$  °C/3.6 °F) with an AF-S NIKKOR 24–70mm f/2.8E ED VR lens. Measurement performed at default settings.
  - Each shot can be up to 29 minutes 59 seconds in length.
  - If camera temperature rises, recording may end before maximum length or size is reached.

## Location Data (GPS/GLONASS)

### ● Location Data and Track Logs

- If **[On]** is selected for **[Location data (built-in)]** > **[Record location data]** in the setup menu or log tracking is progress, the camera will continue to acquire log and/or location even while off.
- Personal information may be inferred from the location data stored in track logs or embedded in photos and movies. Exercise caution when sharing photos, movies, or track logs or when posting them to the Internet or other locations where they can be viewed by third parties. Be sure to also read “Disposing of Data Storage Devices” (📖 255).

### ● Navigation

This product is a camera. It is not intended for use as a navigation or surveying device.

- The location reported by the camera is an approximation only. It is not to be used for surveying or for navigation when travelling by air or car, on foot, or by other means.

### ● Overseas Use

- Before travelling, check with your travel agent or the embassy or tourism board of the countries you will be visiting for information on restrictions that may apply to the use of cameras that support the recording of location data. China, for example, prohibits unauthorized recording of location data. Select **[Off]** for **[Record location data]**.
- As of December, 2019, the location data function may not perform as expected in China and in the vicinity of the Chinese border.



## Trademarks and Licenses

- CFexpress is a trademark of the CompactFlash Association in the United States and other countries.
- NVM Express is a trademark of NVM Express Inc. in the United States and other countries.
- XQD is a trademark of Sony Corporation.
- Windows is either a registered trademark or a trademark of Microsoft Corporation in the United States and/or other countries.
- Apple®, App Store®, the Apple logos, iPhone®, iPad®, iPod touch®, Mac, and macOS are trademarks of Apple Inc. registered in the U.S. and/or other countries.
- Android, Google Play and the Google Play logo are trademarks of Google LLC. The Android robot is reproduced or modified from work created and shared by Google and used according to terms described in the Creative Commons 3.0 Attribution License.
- IOS is a trademark or registered trademark of Cisco Systems, Inc., in the United States and/or other countries and is used under license.

- HDMI, the HDMI logo and High-Definition Multimedia Interface are trademarks or registered trademarks of HDMI Licensing, LLC.

## **HDMI**

- The Bluetooth® word mark and logo are registered trademarks owned by Bluetooth SIG, Inc., and any use of such marks by Nikon is under license.
- Wi-Fi and the Wi-Fi logo are trademarks or registered trademarks of the Wi-Fi Alliance.
- All other trade names mentioned in this manual or the other documentation provided with your Nikon product are trademarks or registered trademarks of their respective holders.

---

Use of the Made for Apple badge means that an accessory has been designed to connect specifically to the Apple products identified in the badge, and has been certified by the developer to meet Apple performance standards. Apple is not responsible for the operation of this device or its compliance with safety and regulatory standards. Please note that the use of this accessory with an Apple product may affect wireless performance.

---

---

### ✔ **FreeType License (FreeType2)**

Portions of this software are copyright © 2012 The FreeType Project (<https://www.freetype.org>). All rights reserved.

### ✔ **MIT License (HarfBuzz)**

Portions of this software are copyright © 2018 The HarfBuzz Project (<https://www.freedesktop.org/wiki/Software/HarfBuzz>). All rights reserved.

### ✔ **Unicode® Character Database License (Unicode® Character Database)**

The software for this product uses the Unicode® Character Database License open-source software. The terms of the software license are as follows:

#### COPYRIGHT AND PERMISSION NOTICE

Copyright © 1991-2019 Unicode, Inc. All rights reserved.

Distributed under the Terms of Use in

<https://www.unicode.org/copyright.html>.

Permission is hereby granted, free of charge, to any person obtaining a copy of the Unicode data files and any associated documentation (the "Data Files") or Unicode software and any associated documentation (the "Software") to deal in the Data Files or Software without restriction, including without limitation the rights to use, copy, modify, merge, publish, distribute, and/or sell copies of the Data Files or Software, and to permit persons to whom the Data Files or Software are furnished to do so, provided that either

- (i) this copyright and permission notice appear with all copies of the Data Files or Software, or
- (ii) this copyright and permission notice appear in associated Documentation.

THE DATA FILES AND SOFTWARE ARE PROVIDED "AS IS", WITHOUT WARRANTY OF ANY KIND, EXPRESS OR IMPLIED, INCLUDING BUT NOT LIMITED TO THE WARRANTIES OF MERCHANTABILITY, FITNESS FOR A PARTICULAR PURPOSE AND NON-INFRINGEMENT OF THIRD PARTY RIGHTS.

IN NO EVENT SHALL THE COPYRIGHT HOLDER OR HOLDERS INCLUDED IN THIS NOTICE BE LIABLE FOR ANY CLAIM, OR ANY SPECIAL INDIRECT OR CONSEQUENTIAL DAMAGES, OR ANY DAMAGES WHATSOEVER RESULTING FROM LOSS OF USE, DATA OR PROFITS, WHETHER IN AN ACTION OF CONTRACT, NEGLIGENCE OR OTHER TORTIOUS ACTION, ARISING OUT OF OR IN CONNECTION WITH THE USE OR PERFORMANCE OF THE DATA FILES OR SOFTWARE.

Except as contained in this notice, the name of a copyright holder shall not be used in advertising or otherwise to promote the sale, use or other dealings in these Data Files or Software without prior written authorization of the copyright holder.

#### **☑ AVC Patent Portfolio License**

THIS PRODUCT IS LICENSED UNDER THE AVC PATENT PORTFOLIO LICENSE FOR THE PERSONAL AND NON-COMMERCIAL USE OF A CONSUMER TO ( i ) ENCODE VIDEO IN COMPLIANCE WITH THE AVC STANDARD ("AVC VIDEO") AND/OR (ii) DECODE AVC VIDEO THAT WAS ENCODED BY A CONSUMER ENGAGED IN A PERSONAL AND NONCOMMERCIAL ACTIVITY AND/OR WAS OBTAINED FROM A VIDEO PROVIDER LICENSED TO PROVIDE AVC VIDEO. NO LICENSE IS GRANTED OR SHALL BE IMPLIED FOR ANY OTHER USE. ADDITIONAL INFORMATION MAY BE OBTAINED FROM MPEG LA, L.L.C. SEE <https://www.mpegla.com>

#### **☑ BSD License (NVM Express Driver)**

The license for the open-source software included in the camera's NVM Express driver is as follows:

<https://imaging.nikon.com/support/pdf/LicenseNVMe.pdf>

---

# Notices

## Notices for Customers in the U.S.A.

### The Battery Charger

## IMPORTANT SAFETY INSTRUCTIONS—SAVE THESE INSTRUCTIONS

## DANGER—TO REDUCE THE RISK OF FIRE OR ELECTRIC SHOCK, CAREFULLY FOLLOW THESE INSTRUCTIONS

For connection to a supply not in the U.S.A., use an attachment plug adapter of the proper configuration for the power outlet if needed. This power unit is intended to be correctly oriented in a vertical or floor mount position.

### Federal Communications Commission (FCC) Radio Frequency Interference Statement

This equipment has been tested and found to comply with the limits for a Class B digital device, pursuant to Part 15 of the FCC rules. These limits are designed to provide reasonable protection against harmful interference in a residential installation. This equipment generates, uses, and can radiate radio frequency energy and, if not installed and used in accordance with the instructions, may cause harmful interference to radio communications. However, there is no guarantee that interference will not occur in a particular installation. If this equipment does cause harmful interference to radio or television reception, which can be determined by turning the equipment off and on, the user is encouraged to try to correct the interference by one or more of the following measures:

- Reorient or relocate the receiving antenna.
- Increase the separation between the equipment and receiver.
- Connect the equipment into an outlet on a circuit different from that to which the receiver is connected.
- Consult the dealer or an experienced radio/television technician for help.



**Nikon**  
D6

### CAUTIONS

#### *Modifications*

The FCC requires the user to be notified that any changes or modifications made to this device that are not expressly approved by Nikon Corporation may void the user's authority to operate the equipment.

#### *Interface Cables*

Use the interface cables sold or provided by Nikon for your equipment. Using other interface cables may exceed the limits of Class B Part 15 of the FCC rules.

Nikon Inc., 1300 Walt Whitman Road, Melville, New York 11747-3064, U.S.A. Tel.: 631-547-4200

## Power Cable

**At voltages over AC 125 V (U.S.A. only):** The power cable must be rated for the voltage in use, be at least AWG no. 18 gauge, and have SVG insulation or better with a NEMA 6P-15 plug rated for AC 250 V 15 A.

## Notice for Customers in Canada

CAN ICES-3 B / NMB-3 B

## Notices for Customers in Europe

**CAUTION:** RISK OF EXPLOSION IF BATTERY IS REPLACED BY AN INCORRECT TYPE. DISPOSE OF USED BATTERIES ACCORDING TO THE INSTRUCTIONS.

This symbol indicates that electrical and electronic equipment is to be collected separately.



The following apply only to users in European countries:

- This product is designated for separate collection at an appropriate collection point. Do not dispose of as household waste.
- Separate collection and recycling helps conserve natural resources and prevent negative consequences for human health and the environment that might result from incorrect disposal.
- For more information, contact the retailer or the local authorities in charge of waste management.

This symbol on the battery indicates that the battery is to be collected separately.



The following apply only to users in European countries:

- All batteries, whether marked with this symbol or not, are designated for separate collection at an appropriate collection point. Do not dispose of as household waste.
- For more information, contact the retailer or the local authorities in charge of waste management.

## Bluetooth and Wi-Fi (Wireless LAN)

This product is controlled by the United States Export Administration Regulations (EAR). The permission of the United States government is not required for export to countries other than the following, which as of this writing are subject to embargo or special controls: Cuba, Iran, North Korea, Sudan, and Syria (list subject to change).

The use of wireless devices may be prohibited in some countries or regions. Contact a Nikon-authorized service representative before using the wireless features of this product outside the country of purchase.

The Bluetooth transmitter in this device operates in the 2.4 GHz band.

### ***Notice for Customers in the U.S.A. and Canada***

This device complies with part 15 of FCC Rules and Innovation, Science and Economic Development Canada's licence-exempt RSSs. Operation is subject to the following two conditions: (1) this device may not cause harmful interference, and (2) this device must accept any interference received, including interference that may cause undesired operation.

### **FCC WARNING**

The FCC requires the user to be notified that any changes or modifications made to this device that are not expressly approved by Nikon Corporation may void the user's authority to operate the equipment.

### **Compliance with FCC requirement 15.407(c)**

Data transmission is always initiated by software, which is then passed down through the MAC, through the digital and analog baseband, and finally to the RF chip. Several special packets are initiated by the MAC. These are the only ways the digital baseband portion will turn on the RF transmitter, which it then turns off at the end of the packet. Therefore, the transmitter will be on only while one of the aforementioned packets is being transmitted. In other words, this device automatically discontinues transmission in case of either absence of information to transmit or operational failure.

Frequency Tolerance:  $\pm 20$  ppm

### **FCC Radio Frequency Interference Statement**

Note: This equipment has been tested and found to comply with the limits for a Class B digital device, pursuant to part 15 of the FCC Rules. These limits are designed to provide reasonable protection against harmful interference in a residential installation. This equipment generates, uses and can radiate radio frequency energy and, if not installed and used in accordance with the instructions, may cause harmful interference to radio communications. However, there is no guarantee that interference will not occur in a particular installation. If this equipment does cause harmful interference to radio or television reception, which can be determined by turning the equipment off and on, the user is encouraged to try to correct the interference by one or more of the following measures:

- Reorient or relocate the receiving antenna.
- Increase the separation between the equipment and receiver.
- Connect the equipment into an outlet on a circuit different from that to which the receiver is connected.
- Consult the dealer or an experienced radio/TV technician for help.

### **Co-location**

This transmitter must not be co-located or operated in conjunction with any other antenna or transmitter.

Nikon Inc., 1300 Walt Whitman Road, Melville, New York 11747-3064, U.S.A.  
Tel.: 631-547-4200



### **FCC/ISED RF Exposure Statement**

The available scientific evidence does not show that any health problems are associated with using low power wireless devices. There is no proof, however, that these low power wireless devices are absolutely safe. Low power Wireless devices emit low levels of radio frequency energy (RF) in the microwave range while being used. Whereas high levels of RF can produce health effects (by heating tissue), exposure of low-level RF that does not produce heating effects causes no known adverse health effects. Many studies of low-level RF exposures have not found any biological effects. Some studies have suggested that some biological effects might occur, but such findings have not been confirmed by additional research. This product has been tested and found to comply with FCC/ISED radiation exposure limits set forth for an uncontrolled environment and meets the FCC radio frequency (RF) Exposure Guidelines and RSS-102 of the ISED radio frequency (RF) Exposure rules. Please refer to the SAR test report that was uploaded to FCC website.

### **Compliance with RSS-247 Issue 2 §6.4**

Data transmission is always initiated by software, which is then passed down through the MAC, through the digital and analog baseband, and finally to the RF chip. Several special packets are initiated by the MAC. These are the only ways the digital baseband portion will turn on the RF transmitter, which it then turns off at the end of the packet. Therefore, the transmitter will be on only while one of the aforementioned packets is being transmitted. In other words, this device automatically discontinues transmission in case of either absence of information to transmit or operational failure.

### **Notice for Customers in Canada**

For indoor use only (5150-5350MHz).

### **Notice for Customers in Europe and in Countries Complying with the Radio Equipment Directive**

Hereby, Nikon Corporation declares that the radio equipment type D6 is in compliance with Directive 2014/53/EU.



The full texts of the EU declarations of conformity are available at the following internet addresses:

[https://imaging.nikon.com/support/pdf/DoC\\_N1823.pdf](https://imaging.nikon.com/support/pdf/DoC_N1823.pdf)

## Notice for Customers in the UK

Hereby, Nikon Corporation declares that the radio equipment type D6 is in compliance with Radio Equipment Regulations 2017.



The full text of the UKCA declaration of conformity is available at the following internet address:

[https://imaging.nikon.com/support/pdf/UKCA\\_DoC\\_N1823.pdf](https://imaging.nikon.com/support/pdf/UKCA_DoC_N1823.pdf)

### Wi-Fi

- Operating frequency:
  - 2412–2462 MHz (channel 11) and 5180–5320 MHz
- Maximum output power (EIRP):
  - 2.4 GHz band: 6.8 dBm
  - 5 GHz band: 9.3 dBm

### Bluetooth

- Operating frequency:
  - Bluetooth: 2402–2480 MHz
  - Bluetooth Low Energy: 2402–2480 MHz
- Maximum output power (EIRP):
  - Bluetooth: 1.3 dBm
  - Bluetooth Low Energy: –0.2 dBm

## Notice for Customers in Singapore

Trade Name: **Nikon**  
Model: D6

This device complies with radio-frequency regulations. The content of certification labels not affixed to the device is given below.

Complies with  
IMDA Standards  
DA103423

## Notice for Customers in Nigeria

Connection and use of this communications  
equipment is permitted by the Nigerian  
Communications Commission

## Security

Although one of the benefits of this product is that it allows others to freely connect for the wireless exchange of data anywhere within its range, the following may occur if security is not enabled:

- Data theft: Malicious third-parties may intercept wireless transmissions to steal user IDs, passwords, and other personal information.
- Unauthorized access: Unauthorized users may gain access to the network and alter data or perform other malicious actions. Note that due to the design of wireless networks, specialized attacks may allow unauthorized access even when security is enabled.
- Unsecured networks: Connecting to open networks may result in unauthorized access. Use secure networks only.

## ☑ Conformance Marking

The standards with which the camera complies can be viewed using the **Conformance marking** option in the setup menu.

## ☑ Certificates

### • Maroc/

المغرب

AGREE PAR L'ANRT MAROC

Numéro d'agrément : MR 21504 ANRT 2019

### • عُمان

Oman-TRA

D090024

TRA/TA-R/8569/19



### • México

La operación de este equipo está sujeta a las siguientes dos condiciones:

- (1) es posible que este equipo o dispositivo no cause interferencia perjudicial y
- (2) este equipo o dispositivo debe aceptar cualquier interferencia, incluyendo la que pueda causar su operación no deseada.

### • Paraguay



**CONATEL**

#### **Emap S.A. (Casa Nissei)**





















Avda Adrian Jara, Esq. Regimiento Piribebuy, Ciudad del Este, Paraguay.



Tel: 595 61 500 115

Fax: 595 61 500 115

# Index

## Symbols

<b>P</b> (Programmed auto) .....	108
<b>S</b> (Shutter-priority auto) .....	108
<b>A</b> (Aperture-priority auto) .....	108
<b>M</b> (Manual) .....	108
<b>S</b> (Single frame) .....	109
<b>CL</b> (Continuous low speed) .....	109
<b>CH</b> (Continuous high speed) .....	109
<b>Q</b> (Quiet shutter release) .....	110
 (Self-timer) .....	110
<b>MUP</b> (Mirror up) .....	110
 (Quick release-mode selection) 110	
 (Single-point AF) .....	102
 (Dynamic-area AF) .....	102
 (3D-tracking) .....	102
 (Group-area AF) .....	103
 (Auto-area AF) .....	103
 (Face-priority AF) .....	105
 (Wide-area AF) .....	105
 (Normal-area AF) .....	105
 (Subject-tracking AF) .....	105
 (Matrix metering) .....	111
 (Center-weighted metering) .....	111
 (Spot metering) .....	112
 * (Highlight-weighted metering) .....	112
 (Live view) button .....	55, 63
<b>i</b> button .....	88
 button .....	94
 (Exposure compensation) button .....	117
 button .....	111
 button .....	125

 button .....	131
 (Help) .....	87
<b>i</b> menu .....	88

## Numerics

3D-tracking .....	102
-------------------	-----

## A

AC adapter .....	198, 207
AF-area mode .....	101
AF-C .....	99
AF-F .....	100
AF-mode button .....	98
AF-ON button .....	107
AF-S .....	99, 100
Angle of view .....	178
Aperture-priority auto .....	108
Attaching a lens .....	35
Auto (Set Picture Control) .....	125
Auto (White balance) .....	122
Auto bracketing .....	113
Auto ISO sensitivity control .....	116
Auto-area AF .....	103
Autofocus mode .....	98

## B

Battery .....	28, 32, 47
Battery charger .....	28
BKT button .....	113
Bluetooth .....	77
Body cap .....	199
Brightness .....	128
Built-in Wi-Fi .....	77

## C

---

Calibration.....	252
Center-weighted metering .....	111
CFexpress card.....	38, 257
Choose color temperature (White balance).....	123
Clarity.....	128
Clean image sensor.....	213
Clock battery.....	46, 221
Cloudy (White balance).....	122
Compatible F mount lenses.....	175
Continuous AF.....	99
Continuous high speed.....	109
Continuous low speed.....	109
Contrast.....	128
CPU contacts.....	182
CPU lens.....	175, 182
Creative Picture Control.....	126

## D

---

Delete.....	76
Depth of field.....	134
Detaching lenses.....	37
Diopter adjustment control.....	14
Direct sunlight (White balance).....	122
Dynamic-area AF.....	102

## E

---

Effect level.....	128
Electronic rangefinder.....	187
Exposure compensation.....	117
Exposure mode.....	108
Exposure preview.....	57, 60
Exposure program.....	231
External microphone.....	68, 203

Eyepiece shutter lever.....	13
-----------------------------	----

## F

---

Face-priority AF.....	105
Fill flash.....	131
Filter effects.....	128
Flash (White balance).....	123
Flash compensation.....	133
Flash mode.....	131
Flash off.....	132
Flash sync speed.....	141
Flash unit.....	189
Flat (Set Picture Control).....	126
Fluorescent (White balance).....	123
<td>135</td>	135
Focus point.....	98
Focus selector lock.....	106
Focus-mode selector.....	97
Full-time AF.....	100

## G

---

Group-area AF.....	103
--------------------	-----

## H

---

H.264.....	243
Highlight-weighted metering.....	112
Histogram.....	95, 96
Hue.....	128

## I

---

Image Dust Off ref photo.....	148
Image quality.....	118
Image size.....	120
Incandescent (White balance).....	122
ISO <small>(FORMAT)</small> button.....	114
ISO sensitivity.....	114

## L

---

L (large).....	120
Landscape (Set Picture Control) .....	126
LCD illuminator.....	8
Live view photography.....	55
Live view selector .....	55, 63
Location data .....	7
Lock mirror up for cleaning.....	216
Low-pass filter.....	213

## M

---

M (medium).....	120
Manual (Exposure mode).....	108
Matrix metering .....	111
Maximum aperture .....	177
Memory card .....	38, 48, 257
Memory card capacity .....	258
<b>MENU</b> button.....	80
Metering .....	111
Microphone.....	65, 203
Mid-range sharpening.....	128
Mirror up mode .....	110
<b>MODE</b> button.....	108
Modeling flash.....	134
Monochrome (Set Picture Control).....	125
Movies.....	63, 73

## N

---

Natural light auto (White balance) .....	122
Neutral (Set Picture Control) .....	125
Non-CPU lens.....	183, 186
Normal-area AF.....	105
NX Studio.....	78

## P

---

Peripheral connector.....	245
Picture Controls .....	125
Playback.....	71, 73
Portrait (Set Picture Control).....	126
Power connector .....	198, 207
Preset manual (White balance).....	123
Press the shutter-release button all the way down.....	52
Programmed auto .....	108
Pv button.....	134

## Q

---

<b>QUAL</b> button.....	118
Quick release-mode selection.....	110
Quick sharp.....	128
Quiet shutter release.....	110

## R

---

Rear-curtain sync.....	132
Rechargeable Li-ion battery .....	28
Red-eye reduction.....	131
Release mode.....	109
Release mode dial.....	109

## S

---

S (small).....	120
Saturation .....	128
Security slot.....	7
Self-timer .....	110
Shade (White balance) .....	122
Sharpening.....	128
Shutter-priority auto .....	108
Shutter-release button.....	51

Single AF .....	99, 100
Single frame .....	109
Single-point AF .....	102
Slow sync .....	131
SnapBridge .....	77
Spot metering .....	112
Standard (Set Picture Control) .....	125
Standby timer .....	53
Stereo microphone (for movies) .....	65
Subject tracking AF .....	105

Wireless Transmitter Utility .....	79
WT-6 .....	78, 201

## X

---

XQD card .....	38, 257
----------------	---------

## T

---

Time zone and date .....	43
Toning .....	128
Touch screen .....	18
Type D lens .....	182
Type E lens .....	182
Type G lens .....	182

## U

---

USB .....	ii, 78
-----------	--------

## V

---

Viewfinder photography .....	50
Virtual horizon .....	95, 96
Vivid (Set Picture Control) .....	125

## W

---

<b>WB</b> button .....	121
White balance .....	121
Wide-area AF .....	105
Wi-Fi .....	77
Wired LAN .....	78
Wireless LAN .....	77, 201
Wireless remote controller .....	201





## Warranty Terms - Nikon Europe Service Warranty

Dear Nikon Customer,

We thank you for your purchasing this Nikon product. Should your Nikon product require warranty service, please contact the dealer from whom it was purchased or a member of our authorized service network within the sales territory of Nikon Europe B.V. (e.g. Europe/Russia/others). See details under:

*<https://www.europe-nikon.com/support>*

In order to avoid any unnecessary inconvenience, we advise you to read the user manuals carefully before contacting the dealer or our authorized service network.

Your Nikon equipment is guaranteed against any manufacturing defects for one full year from the date of original purchase. If during this period of guarantee the product proves defective due to improper material or workmanship, our authorized service network within the sales territory of Nikon Europe B.V. will, without charge for labor and parts, repair the product in the terms and conditions set as below. Nikon reserves the right (at its sole discretion) to replace or repair the product.

1. This warranty is only provided upon presentation of the completed warranty card and original invoice or purchase receipt indicating the date of purchase, product type and dealer's name, together with the product. Nikon reserves the right to refuse free-of-charge warranty service if the above documents cannot be presented or if the information contained in it is incomplete or illegible.

**2. This warranty will not cover:**

- necessary maintenance and repair or replacement of parts due to normal wear and tear.
- modifications to upgrade the product from its normal purpose as described in user manuals, without the prior written consent of Nikon.
- transport costs and all risks of transport relating directly or indirectly to the warranty of the products.
- any damage resulting from modifications or adjustments which may be made to the product, without the prior written consent of Nikon, in order to comply with local or national technical standards in force in any other country than the ones for which the product was originally designed and/or manufactured.

**3. The warranty will not be applicable in the case of:**

- damage caused by misuse including but not limited to failure to use the product for its normal purpose or according to the user instructions on the proper use and maintenance, and to installation or use of the product inconsistent with the safety standards in force in the country where it is used.
- damage caused by accidents including but not limited to lightning, water, fire, misuse or neglect.
- defacing, illegibility or removal of the model or serial number on the product.
- damage resulting from repairs or adjustments which have been conducted by unauthorized service organizations or persons.
- defects in any system into which the product is incorporated or with which it is used.

4. This service warranty does not affect the consumer's statutory rights under applicable national laws in force, nor the consumer's right against the dealer arising from their sales/ purchase contract.

**Notice:** An overview of all authorized Nikon Service Stations can be found online by following this Link  
(URL = <https://www.europe-nikon.com/service/>).

# Nikon Europe Service Warranty Card

Model name

Nikon D6

Serial No.

Purchase date

■ Name and address of customer

■ Dealer

■ Distributor

Nikon Europe B.V.  
The Garden, Stroombaan 14,  
1181 VX Amstelveen, The Netherlands

■ Manufacturer

NIKON CORPORATION  
Shinagawa Intercity Tower C, 2-15-3, Konan,  
Minato-ku, Tokyo 108-6290 Japan

No reproduction in any form of this manual, in whole or in part (except for brief quotation in critical articles or reviews), may be made without written authorization from NIKON CORPORATION.

**NIKON CORPORATION**

© 2020 Nikon Corporation



AMA17090  
Printed in Europe

SB2H03(11)  
6MB46911-03