

RICOH



Digital Camera

RICOH WG-80

Operating Manual

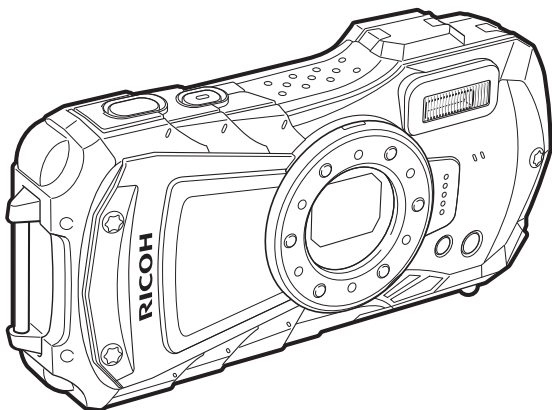

To ensure the best performance from your camera, please read the Operating Manual before using the camera.

Model:R06020

Thank you for purchasing this RICOH WG-80 Digital Camera. Please read this manual before using the camera in order to get the most out of all the features and functions. Keep this manual safe, as it can be a valuable tool in helping you to understand all the camera's capabilities.

Regarding copyrights

Images taken with this digital camera that are for anything other than personal enjoyment cannot be used without permission according to the rights as specified in the Copyright Act. Please take care, as there are cases where limitations are placed on taking pictures even for personal enjoyment during demonstrations, performances or of items on display. Images taken with the purpose of obtaining copyrights also cannot be used outside the scope of use of the copyright as laid out in the Copyright Act, and care should be taken here also.

Regarding trademarks

- SDXC logo is a trademark of SD-3C, LLC.
- Microsoft and Windows are registered trademarks of Microsoft Corporation in the United States of America and other countries.
- Mac, macOS and OS X are trademarks of Apple Inc., registered in the U.S. and other countries.
- HDMI, the HDMI logo, and High-Definition Multimedia Interface are trademarks or registered trademarks of HDMI Licensing, LLC in the United States and/or other countries.
- This product supports PRINT Image Matching III. PRINT Image Matching enabled digital still cameras, printers and software help photographers to produce images more faithful to their intentions. Some functions are not available on printers that are not PRINT Image Matching III compliant. Copyright 2001 Seiko Epson Corporation. All Rights Reserved. PRINT Image Matching is a trademark of Seiko Epson Corporation. The PRINT Image Matching logo is a trademark of Seiko Epson Corporation.
- This product is licensed under the AVC Patent Portfolio License for the personal use of a consumer or other uses in which it does not receive remuneration to (i) encode video in compliance with the AVC standard ("AVC video") and/or (ii) decode AVC video that was encoded by a consumer engaged in a personal activity and/or was obtained from a video provider licensed to provide AVC video. No license is granted or shall be implied for any other use. Additional information may be obtained from MPEG LA, LLC. See <http://www.mpegla.com>.

- All other trademarks are the property of their respective owners.

To users of this camera

- Do not use or store this camera in the vicinity of equipment that generates strong electromagnetic radiation or magnetic fields. Strong static charges or the magnetic fields produced by equipment such as radio transmitters could interfere with the display, damage the stored data, or affect the camera's internal circuitry and cause camera misoperation.
- The liquid crystal panel used for the display is manufactured using extremely high precision technology. Although the level of functioning pixels is 99.99% or better, you should be aware that 0.01% or fewer of the pixels may not illuminate or may illuminate when they should not. However, this has no effect on the recorded image.
- There is a possibility that the illustrations and the screen display in this manual are different from the actual ones.
- In this manual, SD Memory Cards, SDHC Memory Cards and SDXC Memory Cards are referred to as SD Memory Cards.
- In this manual, the generic term "computer(s)" refers to either a Windows PC or a Macintosh.
- In this manual, the term "battery(ies)" refers to any type of batteries used for this camera and its accessories.

Using Your Camera Safely

We have paid close attention to the safety of this camera. When using this camera, we request your special attention regarding items marked with the following symbols.



Warning

This symbol indicates that ignoring this item could cause serious personal injuries.



Caution

This symbol indicates that ignoring this item could cause minor or medium personal injuries, or loss of property.

About the Camera

Warning

- Do not attempt to take the camera apart or modify the camera. High voltages are present within the camera, and there is a danger of electric shock if the camera is taken apart.
- If the inside of the camera should become exposed as a result of, for example, the camera being dropped, please do not under any circumstances touch such exposed portions, as there is a danger of receiving an electric shock.
- Wrapping the strap around a neck is dangerous. Take care that small children do not hang the strap around their necks.
- If any irregularities occur during use, such as smoke or a strange odor, stop use immediately, remove the battery, and contact your nearest service center. Continued use can cause a fire or electric shock.

Caution

- Do not place your finger on the flash when it is discharging as there is a risk of burns.
- Do not discharge the flash while it is touching your clothing as there is a risk of discoloring.
- Some portions of the camera heat up during use, so please take care, as there is a risk of low temperature burns if such portions are held for long periods of time.
- Should the display be damaged, be careful of glass fragments. Also, be careful not to allow the liquid crystal to get on your skin, in your eyes, or in your mouth.
- Depending on your individual factors or physical condition, the use of the camera may cause itching, rashes or blisters. In case of any abnormality, stop using the camera and get medical attention immediately.

About the USB Power Adapter

Warning

- Always use the USB power adapter exclusively developed for this camera, with the specified power and voltage. Using a USB power adapter not exclusive to this camera, or using the exclusive USB power adapter with an unspecified power or voltage can cause a fire, electric shock, or camera breakdown. The specified voltage is 100-240V AC.
- Do not disassemble or modify the product. This can cause a fire or electric shock.
- If the generation of smoke or strange odor from the product or other abnormality occurs, immediately discontinue its use and consult your nearest service center. Continued use can cause a fire or electric shock.
- If water should happen to get inside the product, consult your nearest service center. Continued use can cause a fire or electric shock.
- If you see a lightning flash or hear thunder during use of the USB power adapter, unplug the AC plug and discontinue use. Continued use can cause damage to the product, fire, or electric shock.
- Wipe off the AC plug if it becomes covered with dust. Accumulated dust may cause a fire.

Caution

- Do not place or drop heavy objects on or forcefully bend the USB cable. Doing so may damage the cable. Should the cable be damaged, consult your nearest service center.
- Do not touch or short-circuit the terminal area of the USB cable while the cable is plugged in.
- Do not handle the AC plug with wet hands. This can cause an electric shock.
- Do not subject the product to strong impacts or allow it to drop onto a hard surface. This can cause a malfunction.
- Do not use the USB power adapter to charge a battery other than a rechargeable lithium-ion battery D-LI92. This can cause overheating, explosion, or connected device failure.
- To reduce the risk of hazards, use only a CSA/UL certified power supply cord set, cord is Type SPT-2 or heavier, minimum NO.18 AWG copper, one end with a molded-on male attachment plug cap (with a specified NEMA configuration), and the other is provided with a molded-on female connector body (with a specified IEC nonindustrial type configuration) or the equivalent.

About the Battery

Warning

- Be sure to store the battery out of the reach of small children. Placing it in their mouths may cause an electric shock.
- If any leakage from the battery should come in contact with your eyes, it may cause a loss of sight. Flush your eyes with clean water and get medical attention immediately. Do not rub them.

Caution

- Only use the specified battery with this camera. Use of other batteries may cause an explosion or fire.
- Do not disassemble the battery. Disassembling the battery may cause an explosion or leakage.
- Remove the battery from the camera immediately if it becomes hot or begins to smoke. Be careful not to burn yourself during removal.
- Keep wires, hairpins, and other metal objects away from the + and - contacts of the battery.
- Do not short the battery or dispose of the battery in fire. This can cause an explosion or fire.
- If any leakage from the battery should come in contact with skin or clothes, it may cause irritation to the skin. Wash the affected areas thoroughly with water.
- Precautions for D-LI92 Battery Usage:
 - BATTERY MAY EXPLODE OR FIRE IF MISTREATED.
 - DO NOT DISASSEMBLE OR DISPOSE OF IN FIRE.
 - DO NOT CHARGE EXCEPT SPECIFIED CHARGING CONDITION.
 - DO NOT HEAT ABOVE 140°F / 60°C, OR SHORT CIRCUIT.
 - DO NOT CRUSH OR MODIFY.

Keep the Camera and its Accessories out of the Reach of Small Children

Warning

- Be sure to keep the camera and its accessories out of the reach of small children.
 1. Injuries may result from the product falling or from unexpected movement.
 2. Suffocation may result from wrapping the strap around the neck.
 3. Small accessories such as battery or an SD Memory Card may be swallowed. Seek medical attention immediately if an accessory is accidentally swallowed.

Care to be Taken During Handling

Before Using Your Camera

- When the camera has not been used for a long time, confirm that it is still working properly, particularly prior to taking important pictures (such as at a wedding or when traveling). Contents of the recording cannot be guaranteed if recording, playback or transferring your data to a computer, etc. is not possible due to a malfunction of your camera or recording media (SD Memory Card), etc.
- The lens on this camera is not interchangeable. The lens is not removable.

About the Battery and USB Power Adapter

- To keep the battery in optimum condition, avoid storing it in a fully charged state or in high temperatures.
- If the battery is left inserted and the camera is not used for a long time, the battery will over-discharge and shorten the battery's life.
- Charging the battery a day before use or on the day of use is recommended.
-  Class II equipment: The provided USB power adapter is a Class II (double-insulated) product.

Precautions on Carrying and Using Your Camera

- Hot and humid places should be avoided. Particular care should be taken regarding vehicles, which can become very hot inside.
- Ensure that the camera is not subjected to substantial vibrations, shocks, or pressure as this may cause damage, malfunction, or a loss in waterproof performance. Place the camera on a cushion for protection when the camera is subjected to the vibrations of a motorbike, car, ship, etc. If the camera is subjected to substantial vibrations, shocks, or pressure, take your camera to your nearest service center and have it checked.
- The temperature range in which the camera can be used is -10°C to 40°C (14°F to 104°F).
- The display will become black at high temperatures but will return to normal at normal temperatures.
- The response speed of the display becomes slow at low temperatures. This is due to the properties of the liquid crystal and is not a malfunction.
- If the camera is subjected to rapid temperature changes, condensation may form on the inside and outside of the camera. Therefore put the camera in a bag or plastic bag and take it out when the difference in temperature has subsided.

- Avoid contact with garbage, mud, sand, dust, water, toxic gases, or salt. These could cause the camera to breakdown. Wipe the camera to dry off any rain or water drops.
- Do not press the display with excessive force. This could cause it to break or malfunction.
- Be careful not to sit down with the camera in your back pocket as this may damage the exterior of the camera or the display.
- When using a tripod with the camera, be careful not to overtighten the screw in the tripod socket on the camera.

Cleaning Your Camera

- Do not clean the camera with organic solvents such as thinner, alcohol or benzene.
- Use a lens brush to remove dust accumulated on the lens. Never use a spray blower for cleaning as it may damage the lens.

Storing Your Camera

- Avoid storing the camera where pesticides and chemicals are handled. Remove the camera from its case and store it in a well-ventilated place to prevent the camera from becoming moldy during storage.
- Avoid using or storing the camera where it may be exposed to static electricity or electrical interference.
- Avoid using or storing the camera in direct sunlight or in locations where it may be exposed to rapid changes in temperature or to condensation.
- Periodic inspections are recommended every one to two years to maintain high performance.

Other Precautions

- The SD Memory Card is equipped with a write-protect switch. Setting the switch to LOCK prevents new data from being recorded on the card, the stored data from being deleted, and the card from being formatted by the camera or computer.

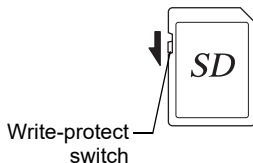

-  appears on the display when the card is write-protected.
- Care should be taken when removing the SD Memory Card immediately after using the camera, as the card may be hot.
- Keep the battery/card cover closed and do not remove the SD Memory Card or turn the camera off while the data is being played back or saved to the card, or the camera is connected to a computer with the USB cable, as this may cause the data to be lost or the card to be damaged.
- Do not bend the SD Memory Card or subject it to violent impact. Keep it away from water and store away from high temperature.
- Do not remove the SD Memory Card during formatting as this may damage the card and render it unusable.
- The data on the SD Memory Card may be lost in the following circumstances. We do not accept any liability for data that is deleted
 - (1) when the SD Memory Card is mishandled by the user.
 - (2) when the SD Memory Card is exposed to static electricity or electrical interference.
 - (3) when the SD Memory Card has not been used for a long time.
 - (4) when the SD Memory Card is ejected or the batteries are removed while the card is being accessed.
- If it is not used for a long time, the data on the card may become unreadable. Be sure to regularly make a backup of important data on a computer.
- Be sure to format SD Memory Cards that are unused or have been used on another camera. Refer to "Formatting the Memory" (p.148).
- When using an SD Memory Card with a slow recording speed, recording may stop while recording a movie even if there is adequate space in the memory, or image capture or playback may take a long time.
- Please note that deleting data, or formatting the SD Memory Cards or the built-in memory does not completely erase the original data. Deleted files can sometimes be recovered using commercially available software. It is user's responsibility to ensure the privacy of such data.

Regarding Waterproof, Dustproof, and Shockproof Design

- This camera is provided with a waterproof/dustproof design complying with JIS waterproof grade 8 and JIS dustproof grade 6 (equivalent to IP68).
- The camera satisfies our drop test (1.6 m height onto a 5 cm thick plywood surface) complying with MIL-Standard 810F Method 516.5-Shock testing.
- The camera satisfies our test for the waterproof, dustproof, and shockproof performance, but this does not guarantee it will remain free of trouble or damages.
- Waterproof performance is not guaranteed if the camera is exposed to impact such as being dropped or hit.

Precautions Before Using the Camera in the Water

Check the Following Before Going Near the Water

- Make sure that there are no cracks or scratches on the rubber seal of the battery/card and terminal covers.

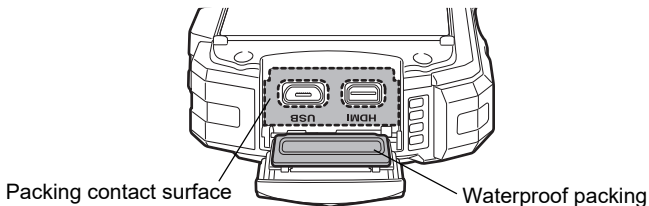
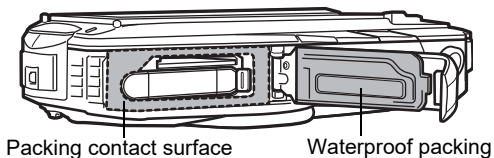

- Make sure that there are no foreign objects (dust, sand, hair, lint or liquid) on the rubber seals or the surface they contact before closing the battery/card and terminal covers. Wipe off any foreign objects with a clean lint-free cloth.
- Close the battery/card and terminal covers properly until they click. Otherwise water may get in and damage the camera.

Be Careful Near the Water

- Avoid opening the battery/card and terminal covers when near the waterside or with wet hands. When changing the battery or the SD Memory Card, avoid places where the camera is likely to get wet or dirty, and make sure that the camera and your hands are completely dry.
- The camera will sink if dropped in water, so be sure to attach the strap to the camera and wrap it around your wrist when using the camera in or near water.
- To enhance the waterproof performance of the camera, the front of the lens is protected by glass. The glass should be kept clean at all times, as any dirt or water on the glass will affect the quality of pictures taken.

Precautions When Using the Camera in the Water

- Do not use the camera deeper than 14 meters underwater. Do not use the camera underwater for more than 120 minutes consecutively.
- Do not open the battery/card and terminal covers underwater.
- Do not use the camera in hot water or in a hot spring.
- Do not apply excessive force to the camera, for example diving into water with it. Doing so may compromise the waterproof performance of the camera or cause the cover to open.
- Do not leave the camera on the sand at the beach, as this may cause the camera to exceed the upper limit of its operational temperature range, or cause the speaker or microphone to become blocked with sand.
- Avoid subjecting the camera to substantial vibrations, shocks, or pressure as this may cause a loss in waterproof performance. If the camera is subjected to substantial vibrations, shocks or pressure, take your camera to your nearest service center and have it checked.
- Avoid getting sunscreen or sun oil on the camera as it may cause discoloration of the surface. If any oil gets on the camera, wash it off immediately with warm water.
- Sudden and extreme changes in temperature may cause condensation to form in and on the camera. Keep the camera in a bag or case to reduce the difference in temperature.





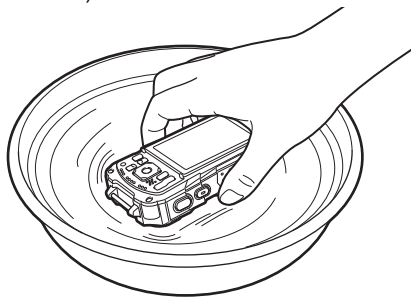

Precautions After Using the Camera in the Water

- Do not open the battery/card and terminal covers if the camera is wet. Wipe off any water with a clean lint-free cloth.
- The inside surface of the covers may get wet when they are opened. Wipe off any water that is on the cover.
- Wiping off the camera while there is sand or dust on it may scratch the surface of the camera. Make sure that the battery/card and terminal covers are firmly closed before washing the camera in tap water. After washing the camera, dry it with a soft cloth.
- Wipe off any dirt or sand on the waterproof seal or the contact surface. The camera's waterproof performance may be compromised by a loose seal, or cracks or dents on the seal or the contact surface. If there is any such damage, contact your nearest service center.
- If the camera becomes very dirty or after it has been used in the sea, make sure that it is turned off and the battery/card and terminal covers are firmly closed before rinsing it under running tap water or leaving it in a bowl of clean water for a short time (2 or 3 minutes).



- Avoid cleaning with agents such as soapy water, mild detergents, or alcohol as this may compromise the waterproof performance of the camera.
- To maintain the waterproof performance of the camera, you are recommended to change the waterproof seal once a year. Contact your nearest service center regarding changing the seal. (A charge will be made.)
- The camera's accessories are not waterproof.

Contents

Using Your Camera Safely	1
Care to be Taken During Handling	5
Regarding Waterproof, Dustproof, and Shockproof Design.....	8
Precautions Before Using the Camera in the Water.....	8
Precautions When Using the Camera in the Water.....	9
Precautions After Using the Camera in the Water.....	10
Contents	11
Composition of the Operating Manual	17
Getting Started	18
<hr/>	
Checking the Contents of the Package.....	18
Names of Parts	19
Names of Operating Parts	20
Display Indications	21
Display in  Mode.....	21
Display in  Mode.....	24
Guide Display	26
Histogram	27
Attaching the Strap	28
Attaching the Strap	28
Powering the Camera	29
Installing the Battery	29
Charging the Battery	31
Installing an SD Memory Card	34
Turning the Camera On and Off.....	36
Starting-up in Playback Mode	37
Initial Settings.....	38
Setting the Display Language	38
Setting the Date and Time.....	41
Common Operations	43
<hr/>	
Understanding the Button Functions.....	43
 Mode	43
 Mode	45
Switching Between  Mode and  Mode.....	47
Setting the Camera Functions	48
Operating the Menus.....	48
Menu List.....	50

Taking Still Pictures	54
Taking Pictures	54
Using the Zoom	57
Setting the Shooting Mode	60
Using the Face Detection Function	63
Taking Pictures in Basic Mode (Green Mode).....	64
Taking Pictures of Your Pet (Pet Mode).....	65
Taking Pictures in Digital Microscope Mode.....	65
Taking Pictures at a Set Interval (Interval Shot).....	66
Using the Self-timer	67
Taking a Series of Pictures (Continuous Shooting/Burst Shooting)	69
Taking Pictures Using a Remote Control Unit (Optional)	70
Taking Pictures with Automatic Exposure Adjustment (Auto Bracketing).....	71
Setting the Shooting Functions	72
Using the Rec. Mode Menu Items	72
Selecting the Flash Mode	73
Selecting the Focus Mode	75
Setting the Image Tone	78
Selecting the Number of Recorded Pixels	79
Selecting the Quality Level of Still Pictures	80
Adjusting the White Balance	82
Setting the AE Metering	84
Setting the Sensitivity	85
Setting AUTO ISO Range	86
Setting the Exposure (EV Compensation).....	86
Correcting the Brightness (D-Range Setting).....	87
Setting Pixel Track SR	88
Switching the Face Detection Function	89
Setting the Blink Detection Function	91
Setting the Instant Review.....	91
Setting the Green Button Function	92
Setting the Image Sharpness (Sharpness)	95
Setting the Saturation/Tone Adjustment.....	95
Setting the Image Contrast (Contrast).....	95
Setting the Date Imprint Function	96
Setting the IQ Enhancer Processing	96
Setting the Macro Light	97
Underwater Shooting	98
Underwater Shooting (Underwater Mode/Underwater Movie Mode).....	98

Recording Movies	100
Recording Movies	100
Recording a Movie Quickly Using the Movie Button	101
Selecting the Number of Recorded Pixels and Frame Rate for Movies	102
Setting the Movie SR (Movie Shake Reduction) Function	103
Suppressing Wind Noises during Movie Recording (Wind Suppression)	104
Combining Pictures Taken at a Set Interval into a Movie (Interval Movie)	104
Using the High Speed Movie Function	107
Saving the Settings (Memory)	108
Playing Back and Deleting Images	110
<hr/>	
Playing Back Images	110
Playing Back Still Pictures	110
Playing Back a Movie	111
Multi-Image Display	112
Using the Playback Functions	114
Slideshow	117
Rotating the Image	119
Zoom Playback	120
Deleting Images	121
Deleting a Single Image	121
Deleting Selected Images	122
Deleting All Images	123
Protecting Images from Deletion (Protect)	124
Connecting the Camera to an AV Device	126
Connecting the Camera to an HDMI Terminal	126

Editing Images	128
Changing the Image Size (Resize).....	128
Cropping Images	129
Processing Images to Make Faces Look Smaller	130
Using the Digital Filters	131
Using the HDR Filter	133
Using the Ink Rubbing Filter	133
Creating a Collage Image.....	134
Red-eye Edit.....	137
Overlaying Your Original Frame on Still Pictures	138
Editing Movies	142
Copying Images	145

Settings

Camera Settings	147
Using the Setting Menu Items	147
Formatting the Memory	148
Changing the Sound Settings.....	149
Changing the Date and Time	150
Setting the Alarm	151
Setting the World Time.....	153
Setting the Text Size on the Menu	155
Changing the Display Language	155
Changing the Naming System of the Folder.....	156
Changing the Naming System of the File	158
Selecting the HDMI Output Format	160
Adjusting the Brightness of the Display.....	160
Adjusting the Brightness of the Display for Outdoor Shooting.....	160
Using the Power Saving Function	161
Using the Auto Power Off Function	162
Setting the Quick Zoom Function	162
Setting the Guide Display	163
Perform Pixel Mapping	163
Changing the Start-up Screen.....	164
Resetting to Default Settings (Reset).....	165
Setting the Startup Shortcut	165
Displaying the Clock Display	166
Light up the LED Macro Lights	167

Connecting to a Computer **168**

Connecting to a Computer	168
Setting the USB Connection Mode	168
Connecting the Camera and a Computer	169
Disconnecting the Camera from the Computer	170
System Requirements	170



Appendix **172**

Functions Available for Each Shooting Mode	172
Messages	176
Troubleshooting	178
Default Settings	180
List of World Time Cities	185
Main Specifications	186
Warranty Policy	191
Index	196

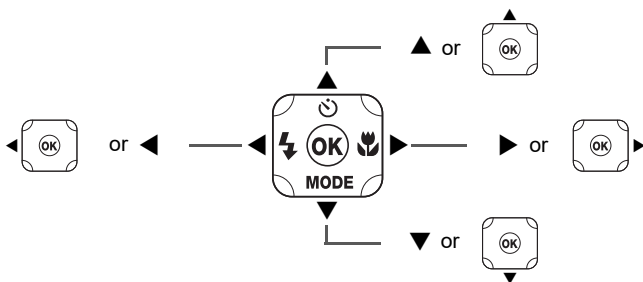
In this manual, the method for operating the four-way controller is shown in illustrations, such as in the ones below.



The meanings of the symbols used in this Operating Manual are explained below.

	Indicates the reference page number for an explanation of the related operation.
	Indicates information that is useful to know.
	Indicates precautions to be taken when operating the camera.

Composition of the Operating Manual

This Operating Manual contains the following chapters.

1 Getting Started

This chapter explains what you need to do after purchasing the camera before you start taking pictures. Be sure to read it and follow the instructions.

2 Common Operations

This chapter explains common operations such as the functions of the buttons and how to use the menus. For more details, refer to the respective chapters below.

3 Taking Pictures

This chapter explains the various ways of capturing images and how to set the relevant functions.

4 Playing Back and Deleting Images

This chapter explains how to view still pictures and movies on the camera or on a TV and how to delete them from the camera.

5 Editing and Printing

This chapter explains the various ways of printing still pictures and how to edit them with the camera.

6 Settings

This chapter explains how to set camera-related functions.

7 Connecting to a Computer

This chapter explains how to connect the camera to a computer.

8 Appendix

This chapter provides some basic troubleshooting tips and other useful information.

1

2

3

4

5

6

7

8

Checking the Contents of the Package

1

Getting Started

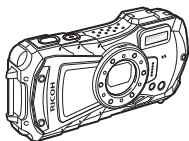

Camera
RICOH WG-80

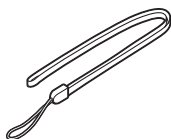

Strap
O-ST104 (*)

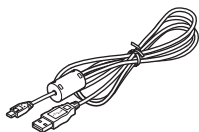

USB cable
I-USB157 (*)
or I-USB170(*)



Rechargeable lithium-ion
battery D-LI92 (*)



USB power
adapter



Power
plug



Macro stand
O-MS1

Start Guide
Regarding Waterproof,
Dustproof, and Shockproof
Design

* Available as optional accessories.

Names of Parts

1

Getting Started

Front

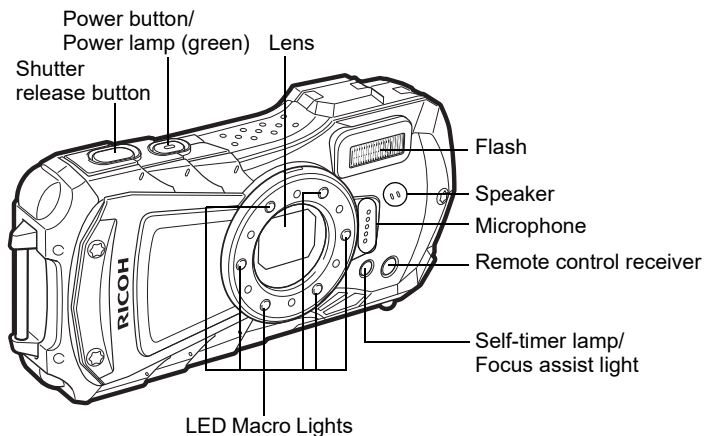

Back

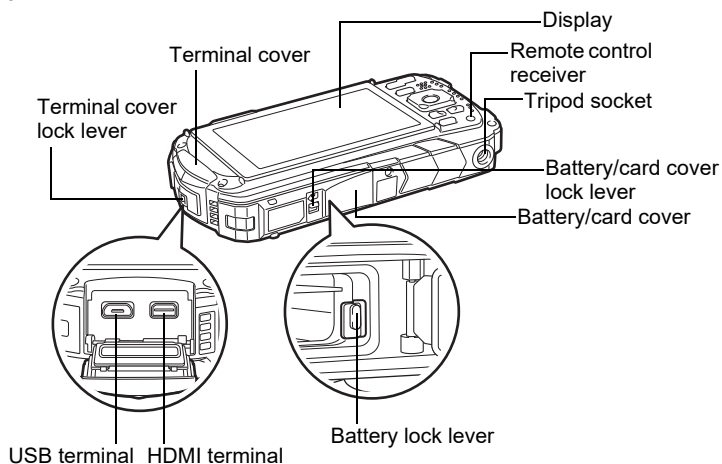

Names of Operating Parts

1

Getting Started

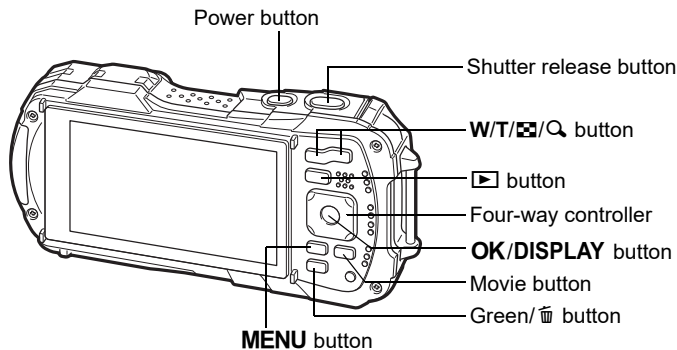

Refer to "Understanding the Button Functions" (p.43 - 46) for an explanation of the function of each button.

Macro stand

Attaching the supplied macro stand (O-MS1) reduces camera shake during shooting in (Digital Microscope) mode (p.65). Insert two clips into the slits in upper and lower sides of the LED Macro Lights part. When attaching and detaching the macro stand, do not hold the clip part.

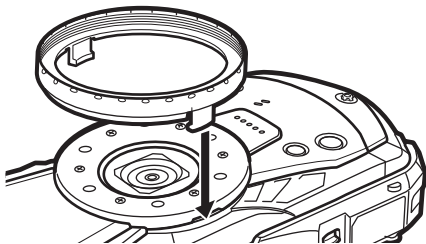

* When using the macro stand, the camera may not be able to focus if the objects have uneven surfaces.

Display Indications

Display in Mode

The display changes in the following sequence each time you press the **OK** button: “Normal Display”, “Histogram + Info”, “Grid Display”, “No Info”, “LCD Off”.





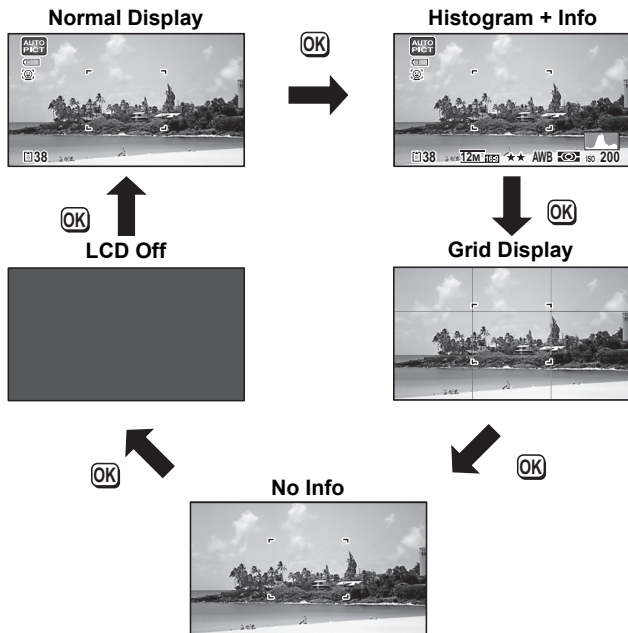

- All the camera buttons function as normal even when the LCD is off. Press the shutter release button to take pictures as normal.
- The display cannot be changed in some shooting modes.

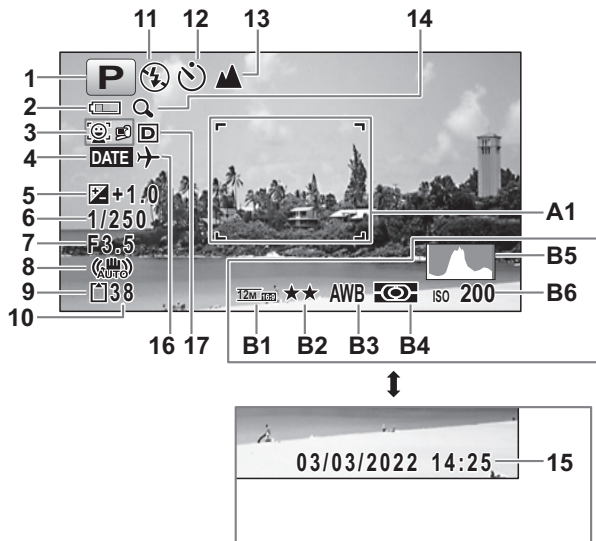

Normal Display/ Histogram + Info/ Grid Display in Still Picture Capture Mode
1 to 17 and A1 appear when “Normal Display” is selected. B1 to B6 appear at the position of 15 when “Histogram + Info” is selected. Only A1 appears when “Grid Display” or “No Info” is selected.



- | | |
|-------------------------------------|--|
| 1 Shooting mode (p.60) | 14 Digital zoom/Intelligent Zoom icon (p.57) |
| 2 Battery level indicator (p.33) | 15 Date and time (p.41) |
| 3 Face Detection icon (p.89) | 16 World Time setting (p.153) |
| 4 Date Imprint setting (p.96) | 17 D-Range Setting (p.87) |
| 5 EV Compensation (p.86) | A1 Focus frame (p.54) |
| 6 Shutter speed | B1 Recorded Pixels (p.79) |
| 7 Aperture | B2 Quality Level (p.80) |
| 8 Pixel Track SR icon (p.88) | B3 White Balance (p.82) |
| 9 Memory status (p.36) | B4 AE Metering (p.84) |
| 10 Remaining image storage capacity | B5 Histogram (p.27) |
| 11 Flash Mode (p.73) | B6 Sensitivity (p.85) |
| 12 Drive Mode (p.67 - p.71) | |
| 13 Focus Mode (p.75) | |

- * 6 and 7 are only displayed when the shutter release button is pressed halfway.
- * For 8,  is displayed when Pixel Track SR is set to (On) on the [Rec. Mode] menu.  is displayed when the shutter release button is pressed halfway if Pixel Track SR is set to (Off) and there is a danger of camera shake.
- * For 13, when the focus mode is set to **AF** and the Auto Macro function is activated,  appears on the display (p.75).
- * 15 appears for two seconds after the camera is turned on.
- * 17 changes depending on [D-Range Setting] settings in the [Rec. Mode] menu. No icon is displayed on the screen when [Highlight Correction] and [Shadow Correction] are both set to [Off].
- * When the shooting mode is  (Auto Picture) and if you press the shutter release button halfway, the automatically selected shooting mode appears in A1 even when “No Info” is selected.
- * If there are overexposed highlight areas in the image, they will blink red on the display, and if there are underexposed shadow areas, they will blink yellow.
- * Some indications may not appear depending on the shooting mode.

Display in Mode

The display shows the shooting information of the image in playback mode. The display changes in the following sequence each time you press the **OK** button:



The display cannot be changed by pressing the **OK** button while playing back or pausing a movie.

Normal Display



OK



Histogram + Info



OK



OK

No Info

Normal Display/ Histogram + Info in Playback Mode

(All of the display items are displayed here for explanatory purposes.)

The display shows information such as the shooting conditions. In "Normal Display", A1 to A9 are displayed. In "Histogram + Info", B1 to B8 are displayed as well.



- | | |
|---|----------------------------------|
| A1 Face Detection icon (p.89) | A9 Volume icon |
| A2 Playback mode
▶ : Still picture (p.110)
▶ : Movie (p.111) | B1 Shutter speed |
| A3 Battery level indicator (p.33) | B2 Aperture |
| A4 Protect icon (p.124) | B3 Histogram (p.27) |
| A5 Four-way controller guide | B4 Sensitivity (p.85) |
| A6 File number | B5 Recorded Pixels (p.79) |
| A7 Folder number (p.156) | B6 Quality Level (p.80) |
| A8 Memory status (p.36) | B7 White Balance (p.82) |
| | B8 AE Metering (p.84) |







- * A1 appears only if the Face Detection function worked when the image was shot.
- * In "Normal Display", A3 disappears if no operation is performed for two seconds.
- * A5 appears even when "No Info" is selected, but disappears if no operation is performed for two seconds. When no operation is performed for two seconds in "Normal Display" or "Histogram + Info", only "Edit" disappears.
- * A9 appears only when the volume is being adjusted during playback of movies (p.111).
- * When "Normal Display" is selected, the shooting date and time appears for two seconds in the B4 to B8 positions.
- * If there are overexposed highlight areas in the image, they will blink red on the display, and if there are underexposed shadow areas, they will blink yellow.

Guide Display

A guide indicator for each available button or key operation appears as follows on the display during operation.

1

▲	Four-way controller (▲)
▼	Four-way controller (▼)
◀	Four-way controller (◀)
▶	Four-way controller (▶)
	MENU button

	Zoom button
	OK button
	Shutter release button
 (green), 	Green/  button
 (red)	Movie button

Histogram

A histogram shows the brightness distribution of an image. The horizontal axis represents brightness (dark at the left and bright at the right) and the vertical axis represents the number of pixels.

The shape of the histogram before and after shooting tells you whether the brightness and contrast are correct or not, and

lets you decide if you need to use EV compensation and take the picture again.

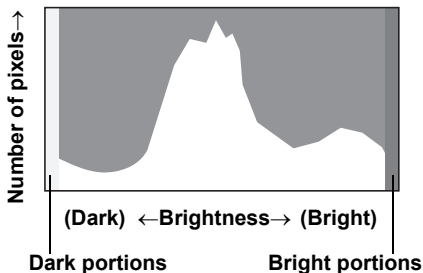

Setting the Exposure (EV Compensation)  p.86

Understanding Brightness

If the brightness is correct, the graph peaks in the middle. If the image is underexposed, the peak is on the left side, and if it is overexposed, the peak is on the right side.

Dark image



Correct image

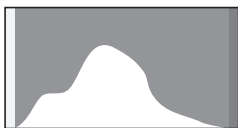

Bright image

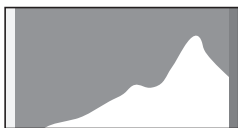

When the image is underexposed, the part to the left is cut off (dark portions) and when the image is overexposed, the part to the right is cut off (bright portions). This camera has a function where overexposed areas are indicated as blinking red and underexposed areas as blinking yellow.

Understanding Contrast

The graph peaks gradually for images in which contrast is balanced. The graph peaks on both sides but sinks in the middle for images with a large difference in contrast and low amounts of mid-level brightness.

Attaching the Strap

1

Getting Started

Attaching the Strap

Attach the strap (O-ST104) supplied with the camera.

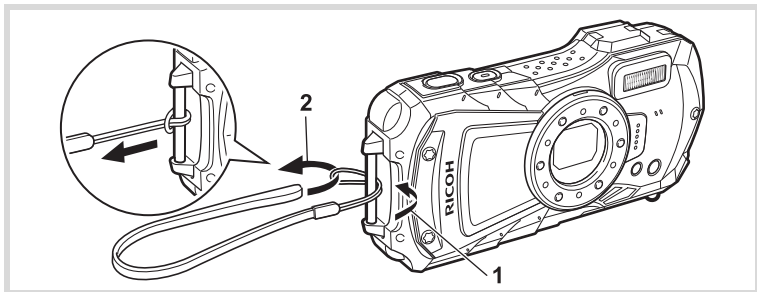

- 1** Pass the narrow end of the strap through the strap lug.
- 2** Pass the other end of the strap through the loop and pull tight.

Installing the Battery

Use the rechargeable lithium-ion battery D-LI92 that is provided with the camera.

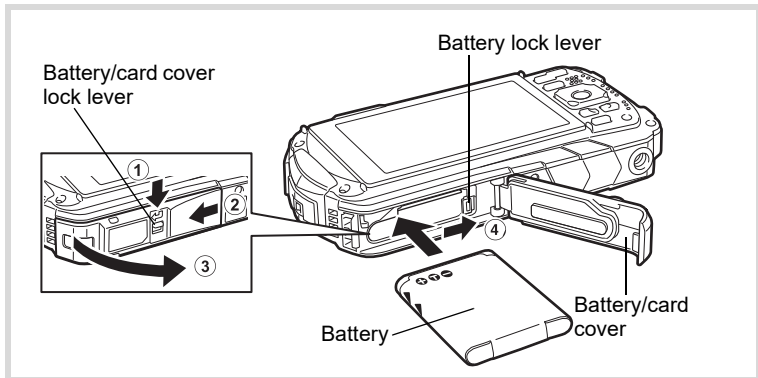

1 Open the battery/card cover.

Press the battery/card cover lock lever in the direction shown ①, slide the cover towards ② and open it towards ③.

2 Using the side of the battery to press the battery lock lever in the direction of ④, insert the battery with the PENTAX logo pointing toward the lens.

Push the battery in until it is locked in place.



If the battery is incorrectly oriented, malfunction may result.

3 Close the battery/card cover.

Push down and slide the battery/card cover with steady but gentle force in the opposite direction indicated by ②.

The battery/card cover may be difficult to close because the waterproof packing is very thick to prevent water from entering the camera. To close the battery/card cover, push down on it toward the camera with your thumb where it says [PUSH]. Then slide it until the battery/card cover lock lever slides into place covering the yellow mark on the lock lever.

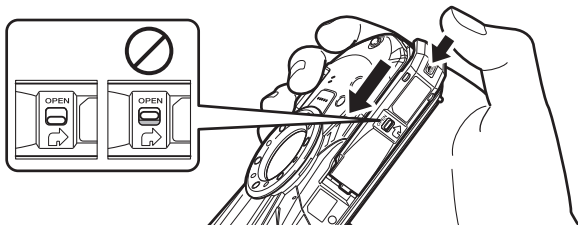

Removing the Battery

- 1 **Open the battery/card cover.**
- 2 **Push the battery lock lever towards ④.**

The battery will be ejected. Take care not to drop the battery when removing it.



- Do not use excessive force when opening and closing the battery/card cover because the waterproof seal may peel off. If the seal is not in the correct position, the camera will not be waterproof.
- If the battery/card cover is not locked securely, water, sand, or dirt may get into the camera.
- This camera uses a rechargeable lithium-ion battery D-LI92. Use of any other type of battery may damage the camera and cause malfunction.
- Insert the battery correctly. If the battery is incorrectly oriented, malfunction may result.
- Do not remove the battery while the camera is turned on.
- When storing the battery for more than 6 months, charge the battery for 30 minutes using the USB power adapter and store the battery separately. Be sure to recharge the battery every 6 to 12 months. Storing the battery below room temperature is ideal. Avoid storing it in high temperatures.
- The date and time may be returned to the default settings if the camera is left without the battery for a long time.
- Be careful as the camera or the battery may become hot when the camera is used continuously for a long period of time.
- Allow the camera to dry completely before changing the battery. Avoid changing the battery where the camera is likely to get wet or dirty, and make sure that your hands are dry.

For Customers in USA and Canada Lithium-Ion batteries are recyclable.

You can help preserve our environment by returning your used rechargeable batteries to the collection and recycling location nearest you.

For more information regarding recycling of rechargeable batteries, call toll free 1-800-822-8837, or visit <http://www.call2recycle.org/>

Charging the Battery

Connect the supplied USB power adapter to the camera and charge the battery before using it for the first time or after a long period of non-use, or when the [Battery depleted] message appears.

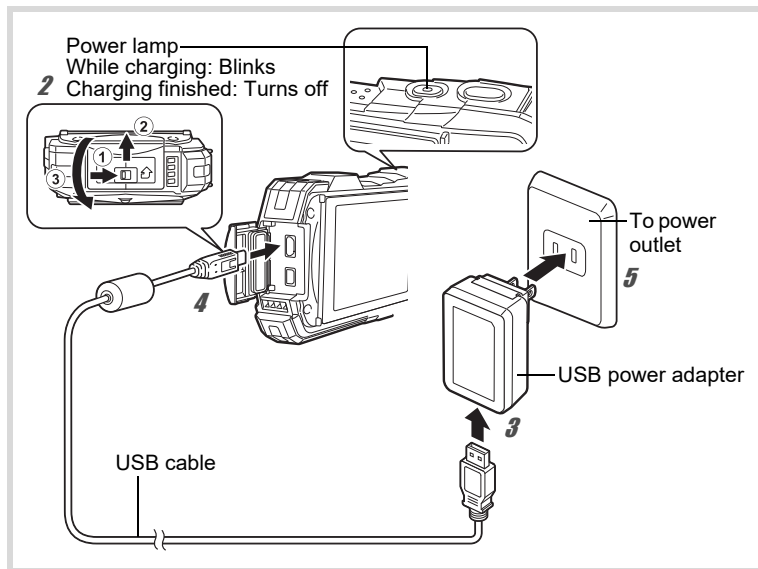

- 1 Insert the power plug to the USB power adapter.**

Insert it until it clicks into place.

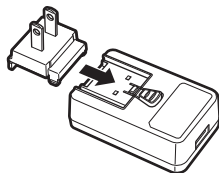

- 2 Make sure that the camera is turned off and open the terminal cover.**

Move the terminal cover lock lever in the direction shown by ①, slide the cover in the direction shown by ② and open the cover in the direction shown by ③.

- 3 Connect the USB cable to the USB power adapter.**

- 4 Connect the USB cable to the camera.**

5 Plug the USB power adapter into the power outlet.

The power lamp blinks while charging.

When charging is finished, the power lamp turns off.

The terminal cover will not close while charging. Leave the cover open when charging and do not attempt to close it.

6 Unplug the USB power adapter from the power outlet when charging is finished.

7 Remove the USB cable from the camera.

8 Close the terminal cover.

Close the terminal cover in the opposite direction indicated by ③. While lightly pressing on the cover, slide it away from ② until it clicks.



- Do not use the supplied USB power adapter for any other purpose than that of connecting to this camera and charging the designated battery. Doing otherwise may cause a connected device to be damaged or overheated.
- The battery has reached the end of its service life when it starts to run down soon after being charged. Replace it with a new battery.
- If the camera is connected to the power outlet but the charging indicator fails to light, the battery may be faulty. Replace it with a new battery.



- The time required to fully charge the battery is about 120 minutes (max.). (The charging time may vary depending on the ambient temperature and charging conditions.) The appropriate ambient temperature for charging the battery is 0°C to 40°C (32°F to 104°F).
- You cannot turn on the camera while it is charging.

- **Image Storage Capacity, Movie Recording Time, and Playback Time (at 23°C (73.4°F) with the display on and the battery fully charged)**

Image Storage Capacity* ¹ (flash used for 50% of shots)	Movie Recording Time* ²	Playback Time* ²
Approx. 300 pictures	Approx. 90 min.	Approx. 260 min.

*1 The image storage capacity shows the approximate number of shots recorded during CIPA-compliant testing (at 23°C (73.4°F) with display on and flash used for 50% of the shots). Actual performance may vary according to operating conditions.

*2 According to the results of in-house testing.



- Battery performance may deteriorate as temperature decreases. When using the camera in cold regions, we recommend carrying a spare battery in your pocket to keep it warm. Battery performance will recover when the temperature returns to normal.
- Be sure to take a spare battery with you when traveling abroad or to a cold region, or if you intend to take a lot of pictures.

• **Battery Level Indicator**

You can check the battery level by the indicator on the display.

Screen Display	Battery Status
(green)	Adequate power remains.
(green)	Battery is running low.
(yellow)	Battery is running very low.
(red)	Battery is exhausted.
[Battery depleted]	The camera will turn off after this message appears.

Installing an SD Memory Card

1

Getting Started

This camera uses SD Memory Cards, SDHC Memory Cards or SDXC Memory Cards. Captured images are saved on the SD Memory Card if a card is inserted in the camera. They are saved in the built-in memory if a card is not inserted (p.36).

Caution

- Be sure to use this camera to format (initialize) an SD Memory Card that is unused or has been previously used on other cameras or digital devices. Refer to “Formatting the Memory” (p.148) for instructions on formatting cards.
- Make sure that the camera is turned off before inserting or removing the SD Memory Card.
- Allow the camera to dry completely before changing the SD Memory Card. Avoid changing the card where the camera is likely to get wet or dirty, and make sure that your hands are dry.
- Do not use excessive force when sliding the battery/card cover open and closed because the waterproof seal may peel off. If the seal is not in the correct position, the camera will not be waterproof.

memo

- The number of still pictures that can be stored varies depending on the capacity of the SD Memory Card and the selected number of recorded pixels and quality level (p.187).
- The power lamp blinks while the SD Memory Card is being accessed (data is being recorded or read).

Backing Up Data

The camera may not be able to access data in the built-in memory in the case of a malfunction. Use a computer or other device to back up important data in another location.

Displaying data stored in the built-in memory

When an SD Memory Card is inserted in the camera, still pictures and movies on the SD Memory Card are displayed. If you want to display still pictures and movies stored in the built-in memory, turn the camera off and remove the SD Memory Card.

Caution

Make sure that the camera is turned off before inserting or removing the SD Memory Card.

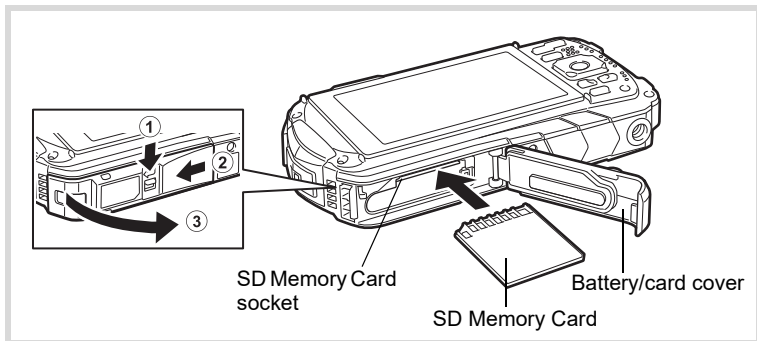

1 Open the battery/card cover.

Press the battery/card cover lock lever in the direction shown ①, slide the cover towards ② and open it towards ③.

2 Insert the SD Memory Card into the SD Memory Card socket so that the label is facing toward the front of the camera (the side with the lens).

Push the card in all the way. Images may not be recorded correctly if the card is not inserted all the way.

To remove the SD Memory Card, push it in once and then pull it out.

3 Close the battery/card cover.

Push down and slide the battery/card cover with steady but gentle force in the opposite direction indicated by ②.



If the battery/card cover is not locked securely when you close it, water, sand, or dirt may get into the camera.



- The image file size varies depending on the number of recorded pixels and the number of images that can be saved on an SD Memory Card also varies.
- Set the number of recorded pixels for still pictures from the [📷 Rec. Mode] menu and for movies from the [🎬 Movie] menu.
- For an approximate number of still pictures and amount of time of movies that can be saved on an SD Memory Card, see "Main Specifications" (p.186).

Turning the Camera On and Off

1

Getting Started

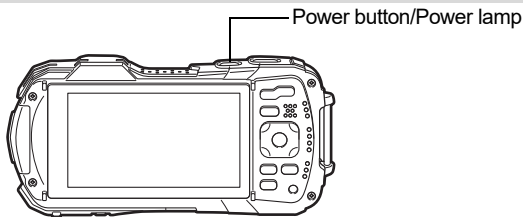

1 Press the power button.

The camera turns on and both the power lamp and display turn on. If the [Language/言語] screen or [Date Adjustment] screen appears when you turn the camera on, follow the procedure on p.38 to set the display language and/or current date and time.

2 Press the power button again.

The camera turns off and both the power lamp and display turn off.

Taking Still Pictures p.54

Checking the SD Memory Card

The SD Memory Card is checked when the camera turns on and the memory status is displayed.

	The SD Memory Card is inserted. Images will be saved on the SD Memory Card.
	The SD Memory Card is not inserted. Images will be saved in the built-in memory.
	The write-protect switch on the SD Memory Card is in the LOCK position (p.7). Images cannot be recorded.



Memory status

Starting-up in Playback Mode

Use this function when you want to play back images straightaway without taking any picture.

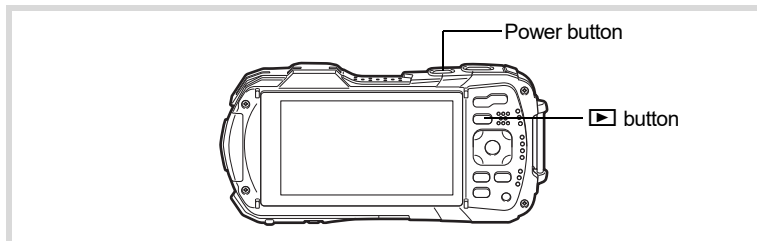

1

Press and hold down the ▶ button.

The display turns on and the camera starts up in playback mode.



- To switch from playback mode to capture mode, press the ▶ button or press the shutter release button halfway.
- In order to set the camera not to start up in playback mode, set [Playback Mode] to □ (Off) from [Startup Shortcut] in the [Setting] menu. (p.165)

Playing Back Still Pictures p.110

1

Initial Settings

The [Language/言語] screen appears when the camera is turned on for the first time. Perform the operations in “Setting the Display Language” below to set the language, and in “Setting the Date and Time” (p.41) to set the current date and time.

The language, date, and time can be changed later. Refer to the pages below for instructions.

- To change the language, follow the steps in “Changing the Display Language” (p.155).
- To change the date and time, follow the steps in “Changing the Date and Time” (p.150).

Setting the Display Language

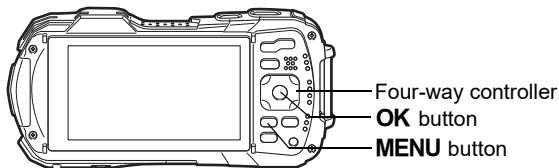

1 Use the four-way controller (▲▼◀▶) to choose the display language.

2 Press the OK button.

The [Initial Setting] screen appears in the selected language. If the desired settings for [🏠 Hometown] and [DST] (Daylight Saving Time) appear, proceed to step 9.

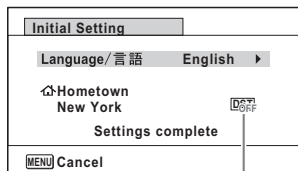

Daylight saving time

3 Press the four-way controller (▼).

The frame moves to [↖ Hometown].

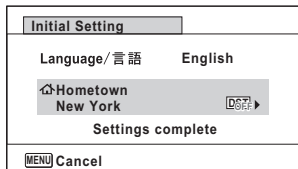
**4 Press the four-way controller (▶).**

The [↖ Hometown] screen appears.

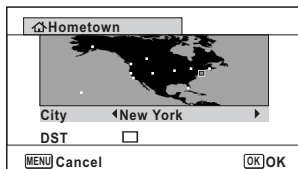
5 Use the four-way controller (◀▶) to choose a city.**6 Press the four-way controller (▼).**

The frame moves to [DST] (Daylight Saving Time).

7 Use the four-way controller (◀▶) to select (On) or (Off).**8 Press the OK button.**

The [Initial Setting] screen reappears.

9 Press the four-way controller (▼) to select [Settings complete].**10 Press the OK button.**

The [Date Adjustment] screen appears. Next, set the date and time.

If you accidentally select the wrong language and go to the next procedure, perform the following operation to set the language back.

● **When the Wrong Language Has Been Inadvertently Selected**

- 1 Press the four-way controller (▶).**
- 2 Use the four-way controller (▲▼◀▶) to select the desired language and press the OK button.**
The [Initial Setting] screen appears in the selected language.

● **When the Screen After Step 2 Appears in the Wrong Language**

- 1 Press the MENU button.**
This exits the setting screen and returns the camera to capture mode.
- 2 Press the MENU button.**
The [📷 Rec. Mode] menu appears.
- 3 Press the four-way controller (▶) twice.**
- 4 Use the four-way controller (▼▲) to select [Language/言語].**
- 5 Press the four-way controller (▶).**
The [Language/言語] screen appears.
- 6 Use the four-way controller (▲▼◀▶) to select the desired language.**
- 7 Press the OK button.**
The [🔍 Setting] menu appears in the selected language.

The language is now switched to your desired language. To reset [Hometown], [Date] and [Time], refer to the pages below for instructions.

- To change the Hometown city, follow the steps in “Setting the World Time” (p.153).
- To change the date and time, follow the steps in “Changing the Date and Time” (p.150).

Setting the Date and Time

Set the current date and time and the display format.

1 Press the four-way controller (▶).

The frame moves to [mm/dd/yy].

2 Use the four-way controller (▲▼) to choose the date and time display format.

Choose from [mm/dd/yy], [dd/mm/yy] or [yy/mm/dd].

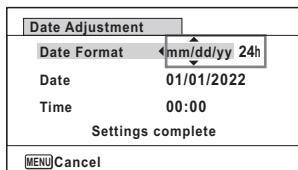

3 Press the four-way controller (▶).

The frame moves to [24h].

4 Use the four-way controller (▲▼) to select [24h] (24-hour display) or [12h] (12-hour display).

5 Press the four-way controller (▶).

The frame returns to [Date Format].

6 Press the four-way controller (▼).

The frame moves to [Date].

7 Press the four-way controller (▶).

The frame moves to the month.

8 Use the four-way controller (▲▼) to change the month.

Change the day and year in the same manner.

Next, change the time.

If you selected [12h] in step 4, the camera switches between am and pm corresponding to the time.

9 Press the four-way controller (▼) to select [Settings complete].

10 Press the OK button.

This confirms the date and time.



If you press the **OK** button in step 10, the camera clock is reset to 0 seconds. To set the exact time, press the **OK** button when the time signal (on the TV, radio, etc.) reaches 0 seconds.



When the [Initial Setting] or [Date Adjustment] screen is displayed, you can cancel the setting operation and switch to capture mode by pressing the **MENU** button. In this case, the [Initial Setting] screen will appear next time you turn the camera on.

1

[Language/言語], [Date], [Time], [Hometown] and [DST] can be changed. Refer to the pages below for instructions.

- To change the language, follow the steps in “Changing the Display Language” (p.155).
- To change the date and time, follow the steps in “Changing the Date and Time” (p.150).
- To change the Hometown city or turn the DST setting on and off, follow the steps in “Setting the World Time” (p.153).

Mode

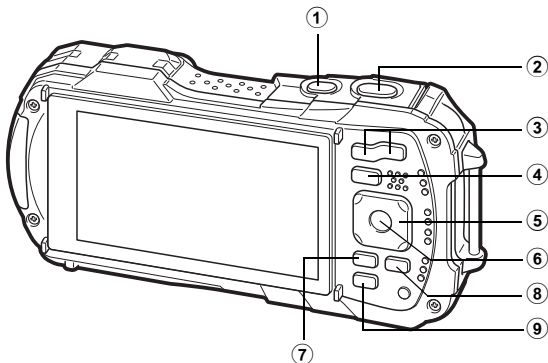

- ① **Power button**
Turns the camera on and off (p.36).
- ② **Shutter release button**
Focuses the camera on the subject when pressed halfway in Still Picture Capture Mode (except when the focus mode is set to **PF**, **▲**, and **MF**) (p.55). Takes a still picture when pressed down fully (p.55). Pressing down fully starts and stops movie recording in **MOVIE** (Movie), **UNDERWATER** (Underwater Movie), and **H.S.** (High Speed Movie) modes (p.98, p.100, and p.107).
- ③ **W/T button**
Changes the captured area (p.57).
- ④ **▶ button**
Switches to **▶** mode (p.47).
- ⑤ **Four-way controller**
 - (▲) : Changes the drive mode (p.67 - p.71).
 - (▼) : Displays the Capture Mode Palette (p.61).
 - (◀) : Changes the flash mode (p.73).
 - (▶) : Changes the focus mode (p.75).
 - (▲▼) : Adjusts the focus when the focus mode is set to **MF** (p.76).

- ⑥ **OK button**
Changes the information on the display (p.21).
- ⑦ **MENU button**
In Still Picture Capture Mode, [📷 Rec. Mode] menu appears. In Movie Mode, [🎬 Movie] menu appears (p.48).
- ⑧ **Movie button**
Starts movie recording in Still Picture Capture Mode (p.101).
- ⑨ **Green button**
Calls up the assigned function (p.92).
Switches to 🟢 (Green) mode (p.64).

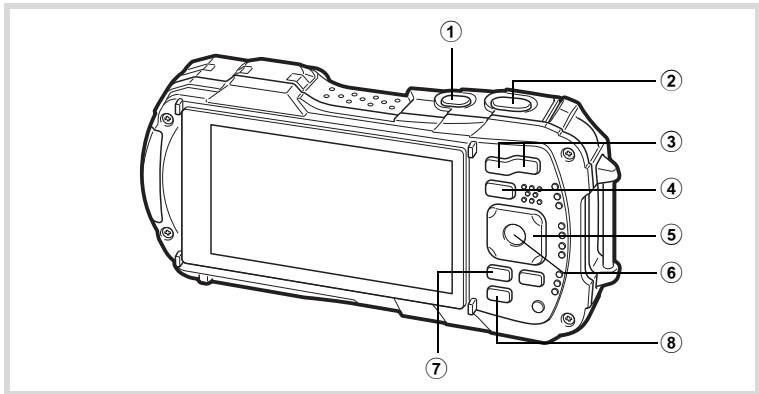



① **Power button**



Turns the camera on and off (p.36).

② **Shutter release button**

Switches to  mode (p.47).

③ **/Q button**

In single-image display, pressing  switches to 6-image display. Pressing  again switches to 12-image display (p.112). Press  to return to the previous display.

In single-image display, pressing  magnifies the image. Press  to return to the previous display (p.120).



In 12-image display, press  to change to folder or calendar display (p.113).

In folder/calendar display, press  to change to 12-image display (p.113).





Adjusts the volume during playback of movies (p.111).

④ ** button**



Switches to  mode (p.47).

- ⑤ **Four-way controller**
- (▲) : Plays back and pauses a movie (p.111).
 - (▼) : Displays the Playback Mode Palette (p.116).
Stops a movie during playback (p.111).
 - (◀▶) : Displays the previous or next image during single-image display (p.110).
Fast-forwards, fast-reverses, frame forwards, and frame reverses during movie playback (p.111).
 - (▲▼◀▶) : Changes the position of the area to be magnified during zoom display (p.120).
Selects an image in 6- or 12-image display, a folder in folder display, and a date in calendar display (p.112, p.113).
Adjusts the position of a frame or an image when you are using the Original Frame function (p.140).
- ⑥ **OK button**
- Changes the information on the display (p.24).
 - Returns zoom, 6- or 12-image display to single-image display (p.113, p.120).
 - Changes to 12-image display of the selected folder during folder display (p.113).
 - Changes to single-image display of the selected date during calendar display (p.114).
- ⑦ **MENU button**
- Displays the [ Setting] menu during single-image display (p.48).
 - Returns to single-image display during Playback Mode Palette display (p.114).
 - Returns zoom, 6- or 12-image display to single-image display.
 - Switches from folder/calendar display to 12-image display with the cursor placed on the most recent image (p.113).
- ⑧ **Green/ button**
- Switches from single-image display to the Delete screen (p.121).
 - Switches from 6- or 12-image display to the Select & Delete screen (p.122).
 - Switches from folder display to the calendar display screen (p.113).
 - Switches from calendar display to the folder display screen (p.113).



Switching Between Mode and Mode

In this manual, the capture mode, such as for taking still pictures and recording movies, is referred to as “ mode” (capture mode) (“Still Picture Capture Mode” refers to the mode for taking still pictures and “Movie Mode” refers to the mode for recording movies). The playback mode, such as for viewing captured images on the display, is referred to as “ mode” (playback mode). In  mode, you can perform simple editing operations on the images that are played back. Follow the procedure below to switch between  mode and  mode.

To Switch from Mode to Mode

- 1 Press the  button.**
The camera switches to  mode.

To Switch from Mode to Mode

- 1 Press the  button or the shutter release button halfway.**
The camera switches to  mode.

Displaying data stored in the built-in memory

When an SD Memory Card is inserted in the camera, still pictures and movies on the SD Memory Card are displayed. If you want to display still pictures and movies stored in the built-in memory, turn the camera off and remove the SD Memory Card.



Make sure that the camera is turned off before inserting or removing the SD Memory Card.

Setting the Camera Functions

To change the camera settings, press the **MENU** button to display the [📷 Rec. Mode] menu or [⚙️ Setting] menu. Functions for playing back and editing images can be accessed from the Playback Mode Palette.

2



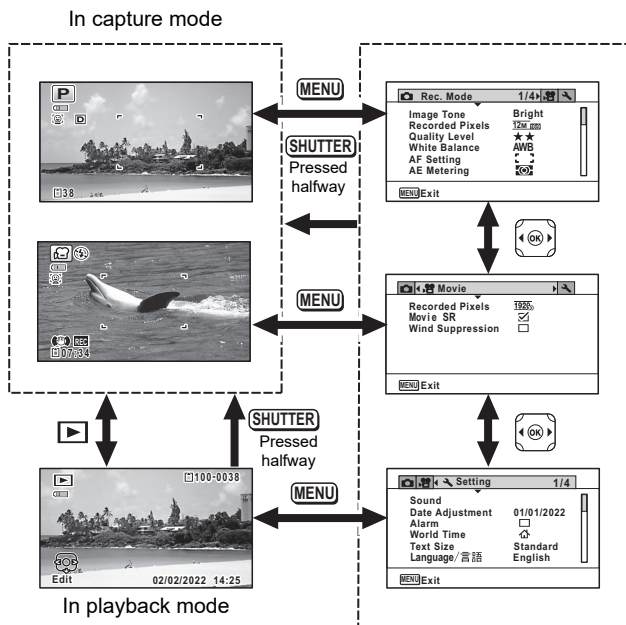

Operating the Menus

There are three types of menus: [📷 Rec. Mode], [🎥 Movie] and [⚙️ Setting]. Press the **MENU** button in Still Picture Capture Mode to display the [📷 Rec. Mode] menu. Press the **MENU** button in Movie Mode to display the [🎥 Movie] menu. Press the **MENU** button in [▶️] mode to display the [⚙️ Setting] menu. Use the four-way controller (◀️▶️) to move between menus.





- Available button and key operations appear on the display during menu operation.
- The **MENU** button function varies depending on the screen. Refer to the guide indications.

	Exit	Exits the menu and returns to the original screen.
		Returns to the previous screen with the current settings.
	Cancel	Cancels the current selection, exits the menu and returns to the previous screen.



Menu List

The following list shows the items that can be set with the menus and provides descriptions of each item. See the list of default settings in the Appendix "Default Settings" (p.180) to check whether the settings are saved when the camera is turned off, and whether the settings return to the default values when the camera is reset.

2

Rec. Mode] Menu

This menu provides the functions related to taking still pictures and recording movies.

Item		Description	Page
Image Tone		For setting the tone of images	p.78
Recorded Pixels		For choosing the number of recorded pixels of still pictures	p.79
Quality Level		For setting the quality level of still pictures	p.80
White Balance		For adjusting the color balance according to the lighting conditions	p.82
AF Setting	Focusing Area	When AF (Standard),  (Macro), or  (1cm Macro) is selected as the focus mode, you can change the autofocus area (Focusing Area)	p.76
	Auto Macro	For choosing whether or not to use the auto macro function	p.77
	Focus Assist	For setting whether or not to use the focus assist light	p.78
AE Metering		For choosing the area of the screen that is metered to determine the exposure	p.84
Sensitivity		For setting the sensitivity	p.85
AUTO ISO Range		For setting the adjustment range when the sensitivity is set to AUTO	p.86
EV Compensation		For adjusting the overall brightness of an image	p.86
D-Range Setting	Highlight Correction	For setting the bright portion correction function	p.87
	Shadow Correction	For setting the dark portion correction function	p.87
Pixel Track SR		For choosing whether to compensate for camera shake while taking still pictures	p.88
Face Detection		For automatically setting the focus and exposure according to faces that are detected and for setting the Self-portrait Assist function	p.89
Blink Detection		For choosing whether to use the Blink Detection function with the Face Detection function	p.91
Digital Zoom		For choosing whether or not to use the digital zoom	p.59
Instant Review		For choosing whether to display Instant Review	p.91

Item	Description	Page
Memory	For choosing whether to save the set values of the shooting functions or return to the defaults when the camera is turned off	p.108
Green Button	For assigning a function to the Green button in  mode	p.92
Sharpness	For choosing sharp or soft outlines	p.95
Saturation (Tone Adjustment)	For setting the color saturation. When [Monochrome] is selected, the item changes to [Tone Adjustment]	p.95
Contrast	For setting the image contrast level	p.95
Date Imprint	For choosing whether to imprint the date and/or time when taking still pictures	p.96
IQ Enhancer*	For setting whether to apply the IQ Enhancer process to an image	p.96
Macro Light	Set On, Off, or Brightness adjustment for the LED for macro photography.	p.97

* IQ Enhancer = Image Quality Enhancer

● [Rec. Mode] Menu 1

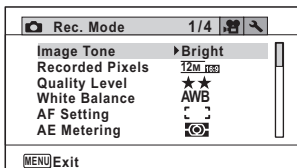

● [Rec. Mode] Menu 2

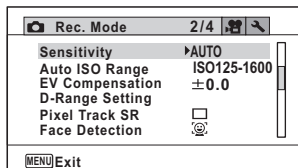

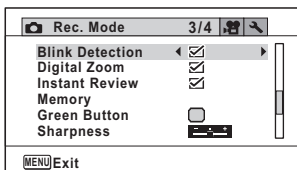

● [Rec. Mode] Menu 3

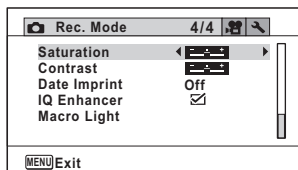

● [Rec. Mode] Menu 4



- Use the  (Green) mode to enjoy easy picture-taking with standard settings, regardless of the settings made from the [ Rec. Mode] menu (p.64).
- Assigning a frequently used function to the Green button enables you to go straight to the desired function (p.92).

[Movie] Menu

Item	Description	Page
Recorded Pixels	For choosing the number of recorded pixels and the frame rate for movies	p.102
Movie SR	For choosing whether or not to use the Movie Shake Reduction function	p.103
Wind Suppression	For suppressing wind noises while recording movies	p.104

● [Movie] Menu

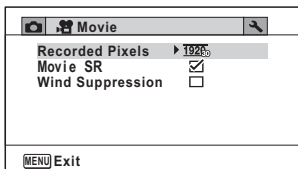

[Setting] Menu

Item	Description	Page
Sound	For adjusting the operation volume and playback volume, and setting the start-up sound, shutter sound, key operation sound, and self-timer sound	p.149
Date Adjustment	For adjusting the date and time	p.150
Alarm	For setting the alarm	p.151
World Time	For setting the Hometown and Destination cities	p.153
Text Size	For setting the text size of the menu	p.155
Language/言語	For setting the language in which menus and messages appear	p.155
Folder Name	For choosing how names are assigned to folders for storing images	p.156
File Name	For choosing how names are assigned to images	p.158
USB Connection	For setting the method for connecting the camera to a PC by the USB cable (MSC or PTP)	p.168
HDMI Out	For setting the HDMI output format when connecting to an AV device with an HDMI terminal	p.160
Brightness Level	For adjusting the brightness of the display	p.160
Outdoor View Stg.	For adjusting the brightness of the display for outdoor shooting	p.160
Power Saving	For setting the time until the camera enters power-saving mode	p.161

Item	Description	Page	
Auto Power Off	For setting the time until the camera turns off automatically	p.162	
Quick Zoom	For choosing whether to use the Quick Zoom function (p.120) when playing back images	p.162	
Guide Display	For setting whether to display explanations for selected items in Capture Mode Palette and Playback Mode Palette	p.163	
Reset	For returning settings other than the date and time, language and world time to their defaults	p.165	
Delete All	For deleting all the images at once	p.123	
Pixel Mapping	For correcting defective pixels on the image sensor	p.163	
Startup Shortcut	Playback Mode	For setting whether to start-up the camera in playback mode	p.165
	LED Lighting	For setting whether to turn the LED Macro Lights on with the camera turned off	p.165
	Clock Display	For setting whether to display the clock with the camera turned off	p.165
Format	For formatting the SD Memory Card/built-in memory	p.148	

● [Setting] Menu 1

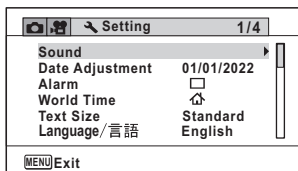

● [Setting] Menu 2

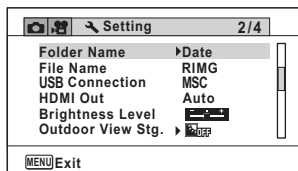

● [Setting] Menu 3

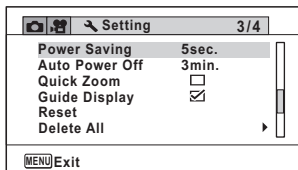

● [Setting] Menu 4

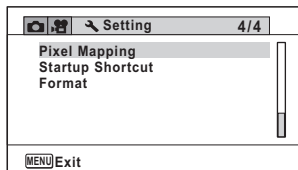

Taking Still Pictures

Taking Pictures

This camera has various functions and shooting modes that support a wide array of scenes and subjects. This section explains shooting with the default settings when shipped.

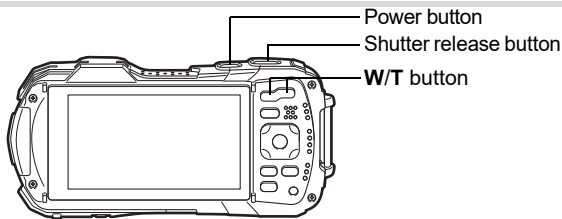

1 Press the power button.

The camera turns on and is ready to take still pictures. In this manual, this is called Still Picture Capture Mode.

2 Check the subject and shooting information on the display.

The focus frame in the middle of the display indicates the automatic focusing area.



Focus frame

When the camera detects a person's face, the Face Detection function is activated and the face detection frame appears (p.63).

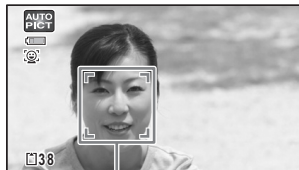

Face detection frame

You can change the captured area by pressing the zoom button (p.57).

Right (**T**) Enlarges the subject.

Left (**W**) Widens the area that is captured by the camera.

3

Press the shutter release button halfway.

The camera emits focus assist light in dark shooting situations.

The focus frame (or face detection frame) on the display turns green when the camera focuses on the subject.



4

Press the shutter release button fully.

The picture is taken.

The flash discharges automatically depending on the light conditions.

The image appears on the display temporarily (Instant Review: p.57) and is saved to the SD Memory Card or the built-in memory.



 is displayed when the shutter release button is pressed halfway if there is a risk of camera shake.

3

Using the Shutter Release Button

The shutter release button works in a two-step action as follows.

Press halfway

This refers to pressing the shutter release button gently to the first position. This locks the focus setting and exposure. The green focus frame lights on the display when the shutter release button is pressed halfway and the subject is in focus. If the subject is out of focus, the frame turns white.

Press fully

This refers to pressing the shutter release button all the way down to the fully depressed position. This takes a picture.

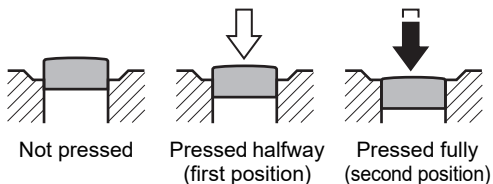

Poor focusing conditions

The camera may not be able to focus under the following conditions. In these cases, lock the focus on an object the same distance away as the subject (by pressing and holding the shutter release button halfway), then aim the camera at your subject and press the shutter release button fully.

- Objects that lack contrast such as a blue sky or white wall
- Dark places or objects, or conditions that prevent light being reflected back
- Intricate patterns
- Fast moving objects
- When both an object in the foreground and an object in the background exist in the captured area
- Strongly reflected light or strong backlighting (bright background)

Instant Review and Blink Detection

The image appears on the display temporarily (Instant Review) immediately after it is captured. If the camera detects that the subject's eyes are closed while Face Detection (p.89) is activated, the message [Closed eyes have been detected] appears for 3 seconds (Blink Detection).



- When the Face Detection function does not work, Blink Detection also does not function. Even if the subjects' faces are recognized, Blink Detection may not function depending on the condition of the recognized faces.
- You can also disable the Blink Detection function (p.91).

Using the Zoom

You can use the zoom to change the captured area.

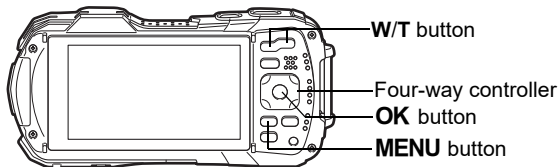

1 Press the W/T button in mode.

W Wide (left)

Widens the area that is captured by the camera.

T Tele (right)

Enlarges the subject.

If you continue to press **T**, the camera automatically switches from optical zoom to Intelligent Zoom and stops at the point where the zoom switches to digital zoom.

Once the button is released and pressed again, the camera switches to digital zoom.

If the digital zoom is set to off in the menu, the optical zoom and the Intelligent Zoom ranges are available for use. The zoom ratio of the Intelligent Zoom varies depending on the number of recorded pixels.

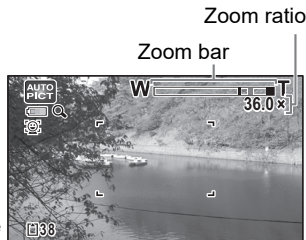

The zoom bar is displayed as follows.

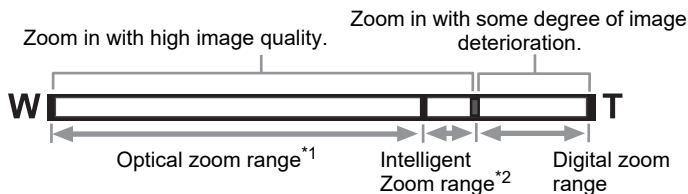

*1 You can zoom in to a maximum of 5x optically.

*2 The Intelligent Zoom range varies depending on the number of recorded pixels. See the following table.

Recorded pixels and the maximum zoom ratio

Recorded Pixels	Intelligent Zoom (The zoom ratio includes the 5x optical zoom.)	Digital zoom
16M / 12M (60) / 12M (61)	Not Available (5x optical zoom only)	Equivalent to approx. 36x
7M / 5M (60)	Approx. 7.5x	
5M / 4M (60)	Approx. 8.9x	
3M (*1)	Approx. 11.3x	
2M (60)	Approx. 12x	
2M (*2)	Not Available (5x optical zoom only)	
1280 (*2)	Not Available (5x optical zoom only)	
1024	Approx. 22.5x	Equivalent to approx. 36x
640	Approx. 36x (same as digital zoom)	

(*1) Intelligent Zoom and digital zoom are not available when (Report) mode is set. (Only 5x optical zoom is available.)

(*2) indicates values that can only be set when (Report) mode is set.



- We recommend you use a tripod to prevent camera shake when taking pictures at high zoom ratios.
- Pictures taken in the digital zoom range appear grainier than pictures taken in the optical zoom range.
- For details on the available functions, refer to "Functions Available for Each Shooting Mode" (p.172).
- The image magnified using Intelligent Zoom may appear rough on the display. This does not affect the quality of the recorded image.
- Intelligent Zoom is available regardless of whether the digital zoom is turned on or off.

To Set the Digital Zoom

The digital zoom is set to (On) in the default settings. To take pictures using only the optical zoom and Intelligent Zoom, set the digital zoom to (Off).

1 Press the **MENU** button in mode.

The [ Rec. Mode] menu appears.

2 Use the four-way controller () to select [Digital Zoom].

3 Use the four-way controller () to switch between (On) or (Off).

- (On) Uses the digital zoom
- (Off) Uses only the optical zoom and Intelligent Zoom

The setting is saved.

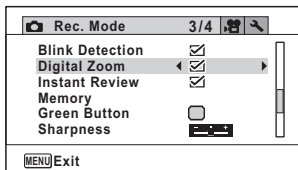

4 Press the **MENU** button.

The camera returns to capture mode.

Saving the Digital Zoom setting  p.108

Setting the Shooting Mode

This camera has a variety of shooting modes that let you take pictures or record movies in different situations simply by choosing the right mode for the particular situation from the Capture Mode Palette.

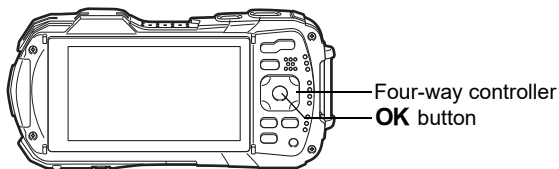

- 1 Press the four-way controller (▼) in  mode.**

The Capture Mode Palette appears.

- 2 Use the four-way controller (▲▼◀▶) to choose a shooting mode.**























































The guide of the selected shooting mode is displayed in the lower part of the display.

















- 3 Press the OK button.**

The shooting mode is selected and the camera returns to capture mode.

The following modes can be selected from the Capture Mode Palette.

Item	Description	Page															
 Auto Picture	<p>The camera automatically selects the appropriate shooting mode from the following fifteen modes</p> <table border="1" data-bbox="358 239 850 676"> <tr> <td data-bbox="358 239 522 337">  Standard </td> <td data-bbox="522 239 685 337">  Night Scene </td> <td data-bbox="685 239 850 337">  Night Scene Portrait </td> </tr> <tr> <td data-bbox="358 337 522 407">  Landscape </td> <td data-bbox="522 337 685 407">  Flower </td> <td data-bbox="685 337 850 407">  Portrait </td> </tr> <tr> <td data-bbox="358 407 522 477">  Sport </td> <td data-bbox="522 407 685 477">  Candlelight </td> <td data-bbox="685 407 850 477">  Blue Sky </td> </tr> <tr> <td data-bbox="358 477 522 575">  Portrait× Blue Sky </td> <td data-bbox="522 477 685 575">  Portrait× Backlight </td> <td data-bbox="685 477 850 575">  Sunset </td> </tr> <tr> <td data-bbox="358 575 522 676">  Portrait× Sunset </td> <td data-bbox="522 575 685 676">  Group Photograph </td> <td data-bbox="685 575 850 676">  Text </td> </tr> </table> <p>* When the camera detects the pet's face, the shutter is automatically released.</p>	 Standard	 Night Scene	 Night Scene Portrait	 Landscape	 Flower	 Portrait	 Sport	 Candlelight	 Blue Sky	 Portrait× Blue Sky	 Portrait× Backlight	 Sunset	 Portrait× Sunset	 Group Photograph	 Text	—
 Standard	 Night Scene	 Night Scene Portrait															
 Landscape	 Flower	 Portrait															
 Sport	 Candlelight	 Blue Sky															
 Portrait× Blue Sky	 Portrait× Backlight	 Sunset															
 Portrait× Sunset	 Group Photograph	 Text															
 Program	<p>Used for basic shooting. The shutter speed and aperture are set automatically by the camera during shooting. However, you can select and set other functions as desired, such as the flash mode and the number of recorded pixels</p>	—															
 HDR	<p>HDR</p> <p>Combines 3 images into a single image delivering a wider dynamic range image</p>	—															
 Handheld Night Snap	<p>Minimizes camera shake for shooting at night or other low light settings</p>	—															
 Movie	<p>For recording movies. Sound is recorded at the same time</p>	p.100															
 High Speed Movie	<p>Captures frames for slow motion playback</p>	p.107															
 Digital Microscope	<p>Captures the bigger images of the closer objects</p>	p.65															
 Landscape	<p>For capturing landscape views. Enhances colors of sky and foliage</p>	—															
 Flower	<p>For images of flowers. The outline of the flower is softened</p>	—															
 Portrait	<p>For capturing portraits. Reproduces a healthy and bright skin tone</p>	—															

Item		Description	Page
	Underwater	For capturing images underwater	p.98
	Underwater Movie	Use this mode for taking underwater movies	p.98
	Interval Shot	Shoots a series of images at a specified interval of time	p.66
	Interval Movie	Shoots a series of images at a specified interval, and saves them as a movie	p.104
	Surf & Snow	For bright images such as sand or snow. Accurately meters for bright scenes	—
	Kids	For capturing moving kids. Reproduces a healthy and bright skin tone	—
	Pet	For capturing images of moving pets	p.65
	Sport	For a fast moving subject. Tracks the subject until the picture is taken	—
	Night Scene	For night time images. Use of a tripod or other support is suggested	—
	Night Scene Portrait	For images of people at night. Use of a tripod or other support is advised	—
	Fireworks	For capturing fireworks. Use of a tripod or other support is suggested	—
	Food	For images of food and prepared dishes. Enhances saturation and contrast	—
	Digital SR	Higher sensitivity reduces blur	—
	Report	For capturing images with an image size suitable for reports	—

*  (Green) (p.64) mode is available in addition to the ones noted above.



- In shooting modes other than (Program), (Night Scene), (Movie), (Digital Microscope), (Handheld Night Snap), (Interval Shot), (Interval Movie), (High Speed Movie), and (Digital SR), Saturation, Contrast, Sharpness, White Balance, etc. are automatically set to the optimal settings for the selected mode.
- In (Digital Microscope) mode, Recorded Pixels can be selected from 12M(16:9), 5M(16:9), 4M(16:9) or 2M(16:9). The maximum magnification varies depending on the Recorded Pixels.
- Some functions may not be available or may not function fully depending on the selected shooting mode. For details, refer to “Functions Available for Each Shooting Mode” (p.172).
- You can turn off the shooting mode guide to be displayed on the Capture Mode Palette (p.163).
- The shutter speed tends to be slower when taking pictures of dark scenes. To prevent camera shake, set the Pixel Track SR to (On) (p.88), or put the camera on a tripod and use the self-timer (p.67) or a remote control unit (p.70).

Using the Face Detection Function

When the camera detects a person's face in the image, the Face Detection function displays a yellow face detection frame around the face on the display screen, sets the focus (Face Detection AF) and compensates the exposure (Face Detection AE).

If the subject in the face detection frame moves, the frame also moves and changes its size as it tracks the face.

The Face Detection function can recognize up to 32 people's faces. If it recognizes multiple faces, the camera displays a yellow frame over the main face and white frames over the other faces. Up to a total of 31 frames, including both the main and white frames can be displayed on the screen.

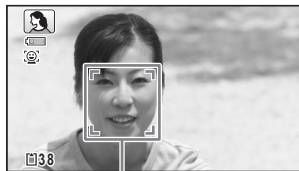

Face detection frame

When the multiple faces are detected

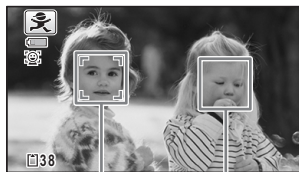

Main frame White frame

Switching the Face Detection Function p.89







Taking Pictures in Basic Mode (Green Mode)





In **●** (Green) mode, you can enjoy easy picture-taking with standard settings, regardless of the settings made from the [ Rec. Mode] menu.

The **●** mode settings are as shown below.



Assign the **●** mode to the [Green Button] in the [ Rec. Mode] menu to use the **●** mode (p.92).

Flash Mode	 (Auto)
Drive Mode	<input type="checkbox"/> (Standard)
Focus Mode	AF (Standard)
Information Display	Normal display
Pixel Track SR	<input type="checkbox"/> (Off)
Recorded Pixels	 12M  4608 x 2592
White Balance	AWB (Auto)
Focusing Area	  (Multiple)
Auto Macro	<input checked="" type="checkbox"/> (On)
Focus Assist	<input checked="" type="checkbox"/> (On)
AE Metering	 (Multi-segment metering)
Image Tone	Bright
Quality Level	★★ (Better)
Highlight Correction	Auto

Shadow Correction	Auto
Sensitivity	AUTO (125-1600)
EV Compensation	±0.0
Blink Detection	<input checked="" type="checkbox"/> (On)
Digital Zoom	<input checked="" type="checkbox"/> (On)
Instant Review	<input checked="" type="checkbox"/> (On)
Sharpness	 (Normal)
Saturation	 (Normal)
Contrast	 (Normal)
Date Imprint	Off
IQ Enhancer	<input checked="" type="checkbox"/> (On)
Macro Light	Off
Face Detection	 (Face Detection On)

1 Press the Green button in mode.

The camera switches to **●** mode.

Press the Green button again to return to the mode before **●** mode was selected.

When the camera detects a person's face, the Face Detection function is activated and the face detection frame appears (p.63).



2 Press the shutter release button halfway.

The focus frame on the display turns green when the camera focuses on the subject.

3 Press the shutter release button fully.

The picture is taken.



- When the **MENU** button is pressed in mode, the [Setting] menu appears. The [Rec. Mode] menu cannot be displayed.
- When the camera is turned off in mode, it turns on in mode next time the power button is pressed.

Taking Pictures of Your Pet (Pet Mode)

In (Pet) mode, the camera automatically releases the shutter when the pet is detected.

1 Use the four-way controller () to select (Pet) from the Capture Mode Palette.

2 Press the **OK** button.
The mode is selected and the camera returns to capture mode.
When the camera detects the pet's face, the shutter is automatically released.

Taking Pictures in Digital Microscope Mode

In (Digital Microscope) mode, you can take pictures of objects as close as 1 cm, also because the LED Macro Lights around the lens are always lighted, you can take minute pictures of text, the veins of leaves, or specimens of tiny insects etc.



The illumination of the LED Macro Lights may be uneven or insufficient depending on the shooting conditions.

1 Use the four-way controller () to select (Digital Microscope) from the Capture Mode Palette.

2 Press the **OK** button.
The mode is selected and the camera returns to capture mode.

3 Press the **W/T** button.
If you press **T**, the camera enlarges the subject.
You can enlarge the subject up to 6.6 times(*).
(*Intelligent Zoom is included. Up to 1.8 times for optical zoom.

W Wide (left)

Widens the area that is captured by the camera.

T Tele (right)

Enlarges the subject.



- Attaching the supplied macro stand (O-MS1) reduces camera shake during macro photography (p.20).
- The maximum magnification that can be set vary depending on the Recorded Pixels.

Taking Pictures at a Set Interval (Interval Shot)

In this mode, a set number of pictures can be taken automatically at a set interval from a set time.

Interval	10 sec. – 99 min.	You can set the shooting interval in increments of one second from ten seconds to 4 minutes, and in 1 minute increments from 4 to 99 minutes. You cannot set the camera to take interval shots at less than ten seconds.
Number of Shots	2 shots – number of recordable images	You can set this up to 1000 shots. However, it cannot exceed the number of recordable images.
Start Delay	0 min. – 24 hours	You can set this in 1-minute increments. If the start time is set to 0 minutes, the first picture is taken as soon as the shutter release button is pressed.

3

Taking Pictures

1 Use the four-way controller (▲▼◀▶) to select  (Interval Shot) from the Capture Mode Palette.

2 Press the OK button.

The current interval shot settings appear for approximately 1 minute. To take pictures with the current settings, go to step 10.

3 Press the OK button while the current settings are displayed. The [Interval Shot] setting screen appears. [Interval] is marked with the frame.

4 Set the interval.

1 Press the four-way controller (▶).

2 Use the four-way controller (▲▼) to set the minutes, then press the four-way controller (▶).

3 Use the four-way controller (▲▼) to set the seconds, then press the four-way controller (▶).

The frame returns to [Interval].

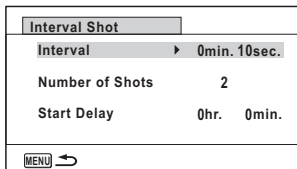

5 Press the four-way controller (▼).

The frame moves to [Number of Shots].

6 Set the number of shots.

1 Press the four-way controller (▶).

2 Use the four-way controller (▲▼) to set [Number of Shots], then press the four-way controller (▶).

The frame returns to [Number of Shots].

7 Press the four-way controller (▼).

The frame moves to [Start Delay].

8 Set the start delay.

1 Press the four-way controller (▶).

2 Use the four-way controller (▲▼) to set the hours, then press the four-way controller (▶).

3 Use the four-way controller (▲▼) to set the minutes, then press the four-way controller (▶).

The frame returns to [Start Delay].

9 Press the MENU button.

The [Interval Shot] settings are saved and the camera returns to capture mode.

10 Press the shutter release button halfway.

The focus frame on the display turns green if the subject is in focus.

11 Press the shutter release button fully.

Interval shooting starts.

The LCD turns off between shots (during standby). Press the power button during standby to display the remaining number of shots and shooting interval on the screen. The [Stop interval shooting?] message is displayed when the power button and then the **MENU** button are pressed during standby. Pressing the **OK** button cancels interval shooting.



- Even if an alarm is set, it will not ring during interval shooting.
- Interval shooting stops if the SD Memory Card is removed or inserted during standby.

Using the Self-timer

In Self-timer mode, a picture is taken ten seconds or two seconds after the shutter release button is pressed.



Stabilize the camera with a tripod or other support when taking a picture with the self-timer.

	Use this mode when you want to be included in a group picture. The picture is taken approximately ten seconds after the shutter release button is pressed.
	Use this mode to avoid camera shake. The picture is taken approximately two seconds after the shutter release button is pressed.

1 Press the four-way controller (▲) in mode.

The [Drive Mode] screen appears.

2 Use the four-way controller (◀▶) to select  and press the four-way controller (▼).

3 Use the four-way controller (◀▶) to select  or  and press the OK button.

The camera is ready to take a picture using the self-timer.

When the camera detects a person's face, the Face Detection function is activated and the face detection frame appears (p.63).



4 Press the shutter release button to take a picture.

The countdown starts and the remaining seconds are displayed on the screen.

If you select 

The self-timer lamp and all of the LED Macro Lights turn on.

From 5 seconds before shooting, the LED Macro Lights turn off in order from the top right.

From 3 seconds before shooting, the self-timer lamp blinks.

If you select 













The self-timer lamp and the LED Macro Lights blink.

The picture is taken after a countdown of either ten seconds or two seconds.





Focusing may be compromised if you move the camera while the self-timer lamp is blinking when taking still pictures.



- In  (Movie),  (Underwater Movie), and  (High Speed Movie) modes, recording will start after ten seconds or two seconds.
- Press the shutter release button halfway while the self-timer is engaged to stop the countdown and press fully to restart the countdown.
-  cannot be selected while the  (Green) mode settings remain at default. Select  in another shooting mode and then switch the shooting mode to .
- The self-timer lamp and LED Macro Lights do not turn on or blink in  (Pet) mode.
- In the following situations, the LED Macro Lights remain turned on regardless of the countdown.
 - In  (Digital Microscope) mode
 - When [Macro Light] in the [ Rec. Mode] menu is set to  (On)
- / cannot be selected in some shooting modes. Refer to “Functions Available for Each Shooting Mode” (p.172) for details.

Taking a Series of Pictures (Continuous Shooting/Burst Shooting)

Pictures are taken continuously as long as the shutter release button is pressed.

	Continuous Shooting	Each time a picture is taken, the image is saved in the memory before the next image is taken. The higher the image quality, the longer the interval between shots.
	Burst Shooting	Takes a series of pictures with intervals between shots shorter than "Continuous Shooting".

* The number of images that can be shot continuously and the interval between shots depend on shooting situations.

1 Press the four-way controller (▲) in mode.

The [Drive Mode] screen appears.



2 Use the four-way controller (◀▶) to select or and press the OK button.

The camera is ready for taking pictures continuously.







3 Press the shutter release button to take a picture.

Pictures are taken continuously as long as you keep the shutter release button pressed.





/ cannot be selected in some shooting modes. Refer to "Functions Available for Each Shooting Mode" (p.172) for details.



- With , you can continue shooting until the capacity of the SD Memory Card or built-in memory becomes full.
- The shooting interval of  varies according to the [Recorded Pixels] and [Quality Level] settings.
- The focus, exposure and white balance are locked with the first shot.
- When the Face Detection function is activated (p.89), it works only when taking the first shot.
- The Blink Detection function works only for the last shot.
- The number of recorded pixels is fixed to  or  in  mode. When the shooting mode is set to  (Report), the number of recorded pixels is fixed to .

Taking Pictures Using a Remote Control Unit (Optional)

You can use a remote control unit (optional) to take pictures while you are away from the camera.

	The shutter will be released after about three seconds when the shutter release button on the remote control unit is pressed.
	The shutter will be released immediately when the shutter release button on the remote control unit is pressed.

3

1 Press the four-way controller (▲) in mode.

The [Drive Mode] screen appears.

2 Use the four-way controller (◀▶) to select and press the four-way controller (▼).

3 Use the four-way controller (◀▶) to select or and press the OK button.

The self-timer lamp begins to blink slowly and the camera is ready to take a picture by remote control.

When the camera detects a person's face, the Face Detection function is activated and the face detection frame appears (p.63).

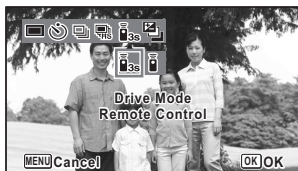

4 Point a remote control unit at the remote control receiver and press the shutter release button on the remote control unit.

The focus frame turns green when the subject is in focus and the camera takes a picture at the following timing.

When  is selected:

The self-timer lamp and the LED Macro Lights blink quickly and the camera takes a picture after about three seconds.

When  is selected:

The camera takes a picture immediately.



- A remote control signal can be received from either receivers on the front and the back of the camera.
- The operating range is approx. 4 m from the front of the camera and approx. 2 m from the back of it.
- In (Movie), (Underwater Movie), and (High Speed Movie) modes, pressing the shutter release button again stops the recording.
- The camera takes a picture even if the focus is not achieved.
- If the shutter release button on the camera is pressed halfway during the countdown, the countdown stops. If the shutter release button on the remote control unit is pressed again, the camera starts the countdown again.
- cannot be selected in some shooting modes. Refer to “Functions Available for Each Shooting Mode” (p.172) for details.
- The self-timer lamp and LED Macro Lights do not turn on or blink in (Pet) mode.

Taking Pictures with Automatic Exposure Adjustment (Auto Bracketing)

Press the shutter release button once to automatically adjust the exposure and take three pictures in succession. After taking the pictures, you can select the best shot from them.

The shooting order is as follows: the proper exposure → -1.0 EV → +1.0 EV.

1

Press the four-way controller (▲) in mode.

The [Drive Mode] screen appears.

2

Use the four-way controller (◀▶) to select (Auto Bracketing) and press the OK button.

The camera is now ready to take pictures with Auto Bracketing.



- When the Instant Review is set to (On) (p.91), the pictures taken are shown in Instant Review after shooting (p.57).
- cannot be selected in some shooting modes. Refer to “Functions Available for Each Shooting Mode” (p.172) for details.

Setting the Shooting Functions

Using the Rec. Mode Menu Items

Settings for shooting are mostly set from the [📷 Rec. Mode] menu. Refer to explanations for each function on how to make these settings.

- 1 Press the MENU button in Still Picture Capture Mode.**
The [📷 Rec. Mode] menu appears.
Pressing the MENU button in Movie Mode displays the [🎥 Movie] menu.
- 2 Use the four-way controller (▲▼◀▶) to select an item and set it up.**

To Save the Setting and Start Taking Pictures

- 3 After setting, press the MENU button.**
The camera returns to capture mode.
The setting is saved and the camera returns to the previous screen.



When the [⚙️ Setting] menu is displayed from [▶️] mode, you can switch to [📷] mode by pressing the [▶️] button.

To Save the Setting and Start Playback of Images

- 3 Press the [▶️] button.**
When the [📷 Rec. Mode], [🎥 Movie] or [⚙️ Setting] menu is displayed from [📷] mode, the setting is saved and the camera returns to playback mode.

To Cancel the Changes and Continue with Menu Operations

- 3 Press the MENU button.**
The changes are canceled and you can select a menu.



- Some functions may not be available or may not function fully depending on the selected shooting mode. For details, refer to “Functions Available for Each Shooting Mode” (p.172).
- The **MENU** button function varies depending on the screen. Refer to the guide indications.

MENU Exit	Exits the menu and returns to the original screen.
MENU	Returns to the previous screen with the current settings.
MENU Cancel	Cancels the current selection, exits the menu and returns to the previous screen.

Selecting the Flash Mode

	Auto	The flash discharges automatically depending on the light conditions.
	Flash Off	The flash does not discharge, regardless of the brightness. Use this mode to take pictures where flash photography is prohibited.
	Flash On	The flash discharges for each shot regardless of the brightness.
	Auto + Red-eye	This mode reduces the red-eye phenomenon caused by the light from the flash being reflected in the subject's eyes. The flash discharges automatically.
	Flash On + Red-eye	This mode reduces the red-eye phenomenon caused by the light from the flash being reflected in the subject's eyes. The flash discharges regardless of the light conditions.
	Macro Light	Light is emitted from the LED surrounding the lens.







- The available modes differ depending on the selected shooting mode, focus mode or drive mode. Refer to “Functions Available for Each Shooting Mode” (p.172) for details.
- If you use the Face Detection function when is selected, the flash mode is automatically set to .
- A pre-flash discharges when using the red-eye reduction function.





Using the flash when capturing images at a close distance may cause irregularities in the image due to the light distribution.

1 Press the four-way controller (◀) in mode.

The [Flash Mode] screen appears. The flash mode changes each time the button is pressed. You can also change the setting using the four-way controller (▲▼).

In  (Underwater) mode,  (Flash Off + Flash On (2 shots)) appears instead of  (Auto + Red-eye) and  (Flash On + Red-eye) as shown on the right.



When you select  (Flash Off + Flash On (2 shots)), two images are taken in succession in  (Flash Off) and  (Flash On). After taking the pictures, you can select the best shot from them.



2 Press the OK button.

The setting is saved and the camera returns to capture mode.





About the red-eye phenomenon

Taking pictures using the flash may cause the subject's eyes to appear red in the resulting picture. This phenomenon occurs when the light from the flash is reflected in the subject's eyes. It can be reduced by increasing the illumination in the area around the subject and/or decreasing the subject distance and adjusting the lens to wider angle setting. Setting the flash mode to  (Auto + Red-eye) or  (Flash On + Red-eye) is also an effective way of reducing red eyes.

If the subject's eyes appear red despite such precautions, they can be corrected by the Red-eye Edit function (p.137).

Saving the Flash Mode setting  p.108

Selecting the Focus Mode

AF	Standard	This mode is used when the distance to the subject is from 50 cm to ∞ . The camera is focused on the subject in the autofocus area when the shutter release button is pressed halfway.
	Macro	This mode is used when the distance to the subject is from 10 cm to 60 cm. The camera is focused on the subject in the autofocus area when the shutter release button is pressed halfway.
	1cm Macro	This mode is used when the distance to the subject is from 1 cm to 30 cm. The camera is focused on the subject in the autofocus area when the shutter release button is pressed halfway.
PF	Pan Focus	This mode is used when you ask someone to take pictures for you, or when taking pictures of the scenery through the window of a car or train. The entire picture, from the front to the back, is focused.
	Infinity	This mode is used for taking distant objects. The flash is set to  (Flash Off).
MF	Manual Focus	This mode lets you adjust the focus manually.

1 Press the four-way controller (▶) in mode.



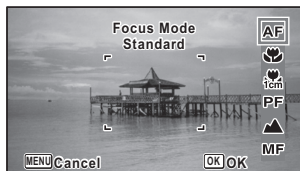

The [Focus Mode] screen appears.
The focus mode changes each time the button is pressed. You can also change the setting using the four-way controller (▲▼).



2 Press the OK button.

The setting is saved and the camera returns to capture mode.



- The available modes differ depending on the selected shooting mode. Refer to “Functions Available for Each Shooting Mode” (p.172) for details.
- The noise from focusing is recorded when a focus mode other than **PF** or  is selected in  (Movie),  (Underwater Movie), and  (High Speed Movie) modes.
- When [Auto Macro] is on and shooting with  selected, if the subject is further than 60 cm away, the camera automatically focuses to ∞ (Infinity).

Saving the Focus Mode setting  p.108

To Set the Manual Focus

The procedure for setting the focus manually (**MF**) is described here.

1 Press the four-way controller (▶) in mode.

The [Focus Mode] screen appears.

2 Use the four-way controller (▶) to select **MF**.

3 Press the **OK** button.

The central portion of the image is magnified to full screen on the display.

4 Press the four-way controller (▲▼).

The **MF** indicator appears on the display to indicate the approximate distance to the subject. Use the four-way controller (▲▼) to adjust the focus using the indicator as a guide.

- ▲ for distant focus
- ▼ for closer focus



MF indicator

5 Press the **OK** button.

The focus is locked and the camera returns to capture mode.

After the focus is locked, you can press the four-way controller (▶) again to display the **MF** indicator and readjust the focus.





The shooting mode and drive mode cannot be changed while the **MF** indicator is displayed.



To switch from **MF** to another focus mode, press the four-way controller (▶) while the **MF** indicator is displayed.

Changing the Autofocus Area

You can change the autofocus area (Focusing Area).

 Multiple	Uses the normal autofocus area.
 Spot	Makes the focusing area smaller.
 Automatic Tracking	Tracks a moving subject and keeps it in focus.

- 1** Use the four-way controller (▲▼) to select [AF Setting] in the [📷 Rec. Mode] menu.
- 2** Press the four-way controller (▶).
The [AF Setting] screen appears.
- 3** Use the four-way controller (▲▼) to select [Focusing Area].
- 4** Press the four-way controller (▶).
A pull-down menu appears.
- 5** Use the four-way controller (▲▼) to change the autofocus area.
- 6** Press the OK button.
The setting is saved.



The available modes differ depending on the selected shooting mode. Refer to “Functions Available for Each Shooting Mode” (p.172) for details.

Setting the Auto Macro

When [Auto Macro] is set to (On), the focus is adjusted to the macro range (distance to the subject is 10 cm to 60 cm) as necessary, even if the focus mode is set to **AF** (Standard).

When it is off and the focus mode is set to **AF** (Standard), the AF operates only in the standard range, and focusing is not done in the macro range.

When the focus mode is set to (Macro) or (1cm Macro), the focus is only adjusted in the respective macro ranges and is not done in the standard range.

- 1** Use the four-way controller (▲▼) to select [AF Setting] in the [📷 Rec. Mode] menu.
- 2** Press the four-way controller (▶).
The [AF Setting] screen appears.
- 3** Use the four-way controller (▲▼) to select [Auto Macro].
- 4** Use the four-way controller (◀▶) to select (On)/ (Off).
The setting is saved.

Setting the AF Assist Light (Focus Assist)

The camera automatically emits the focus assist light in dark shooting situations. You can set the light to on or off.

- 1 Use the four-way controller (▲▼) to select [AF Setting] in the [📷 Rec. Mode] menu.**
- 2 Press the four-way controller (▶).**
The [AF Setting] screen appears.
- 3 Use the four-way controller (▲▼) to select [Focus Assist].**
- 4 Use the four-way controller (◀▶) to select (On)/ (Off).**
The setting is saved.



Looking at the light directly will not create a safety hazard. However, do not look into the emitter from a very short distance since you may feel dazzled.



The camera does not emit the focus assist light depending on the selected shooting mode or focus mode. Refer to "Functions Available for Each Shooting Mode" (p.172) for details.

Setting the Image Tone

For setting the tone of images.

You can select from [Bright], [Natural], [Vibrant], [Slide Film], [Monochrome], or [Cross Processing].

The default setting is [Bright].

- 1 Use the four-way controller (▲▼) to select [Image Tone] in the [📷 Rec. Mode] menu.**
- 2 Press the four-way controller (▶).**
A pull-down menu appears.
- 3 Use the four-way controller (▲▼) to select a finishing tone.**
- 4 Press the OK button.**
The setting is saved.



- When [Monochrome] is selected, [Tone Adjustment] appears in the [📷 Rec. Mode] menu for setting the tone of monochrome images instead of [Saturation].
- The finishing tone may not be changed depending on the shooting mode. Refer to “Functions Available for Each Shooting Mode” (p.172) for details.

Selecting the Number of Recorded Pixels

You can choose the number of recorded pixels for still pictures.

The larger the number of recorded pixels, the clearer the details will appear when you print your picture. As the quality of the printed picture also depends on the image quality, exposure control, resolution of the printer, and other factors, you do not need to select more than the required number of recorded pixels. [3M] is adequate for making postcard-size prints. The more pixels there are, the larger the picture and the bigger the file size.

Refer to the following table for the appropriate setting according to expected usage.

Recorded Pixels	Expected Usage
[16M] 4608 x 3456	For printing high quality photos or A4-size pictures or larger, or editing images on a computer.
[12M] [16:9] 3456 x 3456	
[12M] [16:9] 4608 x 2592	
[7M] 3072 x 2304	
[5M] [16:9] 3072 x 1728	
[5M] 2592 x 1944	For making postcard-size prints.
[4M] [16:9] 2592 x 1464	
[3M] 2048 x 1536	
[2M] 1600 x 1200	
[2M] [16:9] 1920 x 1080	For posting on a website or attaching to e-mails.
[1280] 1280 x 960	
[1024] 1024 x 768	
[640] 640 x 480	

- The default setting is [12M] [16:9].
- [2M] and [1280] can be set only when [Report] mode is set. These icons do not appear in the [Recorded Pixels] options.



If you select [16M]/[7M]/[5M]/[3M]/[2M]/[1024]/[640], the aspect ratio of the screen is 4:3. The monitor display for image capture and playback is as shown on the right.



- 1 Use the four-way controller (▲▼) to select [Recorded Pixels] in the [Rec. Mode] menu.
- 2 Press the four-way controller (▶).
A pull-down menu appears.
- 3 Use the four-way controller (▲▼) to change the number of recorded pixels.
- 4 Press the OK button.
The setting is saved.



The selectable number of recorded pixels differs depending on the shooting mode. Refer to “Functions Available for Each Shooting Mode” (p.172) for details.

Selecting the Quality Level of Still Pictures

Select the quality level (data compression ratio) for still images according to how the images will be used.

The more stars (★), the higher the quality of the image, but the file size increases. The selected number of recorded pixels also affects the size of the image file (p.79).

Quality Level

★★★	Best	Lowest compression ratio. Suitable for photo prints.
★★	Better	Standard compression ratio. Suitable for viewing the image on a computer screen. (default setting)
★	Good	Highest compression ratio. Suitable for attaching to e-mails or creating websites.

- 1 Use the four-way controller (▲▼) to select [Quality Level] in the [Rec. Mode] menu.

2 Press the four-way controller (▶).

A pull-down menu appears.

3 Use the four-way controller (▲▼) to change the quality level.











The number of recordable still pictures is displayed at the top of the screen when you select a quality level.

4 Press the OK button.

The setting is saved.

Adjusting the White Balance

You can take pictures in natural colors by adjusting the white balance according to the light conditions at the time of shooting.

AWB	Auto	The camera adjusts the white balance automatically.
	Daylight	Use this mode when taking pictures outside in sunlight.
	Shade	Use this mode when taking pictures outside in the shade.
	Tungsten Light	Use this mode when taking pictures under tungsten lamps or electric lights other than fluorescent.
	Daylight Colors	Use this mode when taking pictures under fluorescent light.
	Fluorescent	
	Daylight White	
	Fluorescent	
	White Light	
	Fluorescent	
	Manual	Use this mode when adjusting the white balance manually.



- Set another white balance if you are not satisfied with the color balance of pictures taken with the white balance set to **AWB**.
- The white balance setting may not be changed depending on the selected shooting mode. Refer to “Functions Available for Each Shooting Mode” (p.172) for details.

1 Use the four-way controller (▲▼) to select [White Balance] in the [Rec. Mode] menu.

2 Press the four-way controller (▶).
The [White Balance] screen appears.

3 Use the four-way controller (▲▼) to change the setting.

You can check the results of available white balance settings on the preview image each time you press the four-way controller.

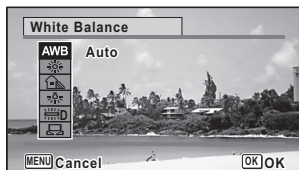

4 Press the OK button.

The setting is saved.

Refer to the following instructions if you want to set the white balance by selecting the fluorescent light type, or adjust it manually.



If you change the [White Balance] setting frequently, you can save time by assigning the Fn Setting to the Green button (p.92).

Saving the White Balance setting p.108

Selecting the Fluorescent Light Type

Select the proper fluorescent light type from D (Daylight Colors Fluorescent), N (Daylight White Fluorescent), or W (White Light Fluorescent).

- 1 In the [White Balance] screen, use the four-way controller () to select [D (Daylight Colors Fluorescent)].
- 2 Press the four-way controller ().
- 3 Press the four-way controller () to select the fluorescent light type.
- 4 Press the OK button.
The setting is saved.



The icon displayed on the [White Balance] screen changes when the fluorescent light type is changed.

Manual Setting

Have a blank sheet of white paper or similar material ready.



- 1 In the [White Balance] screen, use the four-way controller () to select (Manual).
- 2 Point the camera at the blank sheet of paper or other material so that it fills the frame displayed in the center of the screen.
- 3 Press the shutter release button fully.
The white balance is automatically adjusted.

4 Press the OK button.

The setting is saved and the screen returns to the [📷 Rec. Mode] menu.

Setting the AE Metering

You can set the area of the screen where the brightness is metered to determine the exposure.

	Multi-segment metering	The camera divides the screen into 256 areas, meters the brightness and determines the exposure.
	Center-weighted metering	The camera takes a reading of the overall brightness of the screen with the center of the screen having more influence on the exposure.
	Spot AE metering	The camera determines the exposure by metering the brightness only at the center of the screen.

1 Use the four-way controller (▲▼) to select [AE Metering] in the [📷 Rec. Mode] menu.

2 Press the four-way controller (▶).

A pull-down menu appears.

3 Use the four-way controller (▲▼) to select a metering method.

4 Press the OK button.

The setting is saved.



- When the shutter release button is pressed halfway, the brightness is metered and the exposure is determined.
- When the subject is not at the center of the screen and you want to use the Spot AE metering, center the subject on the screen and press and hold the shutter release button halfway to lock the exposure, then compose your picture again and press the shutter release button fully.
- The AE Metering setting may not be changed depending on the selected shooting mode. Refer to “Functions Available for Each Shooting Mode” (p.172) for details.

Saving the AE Metering setting  p.108

Setting the Sensitivity

You can select the sensitivity to suit the brightness of the surroundings.

AUTO	The sensitivity is automatically set by the camera. (Default value: sensitivity 125-1600)
125	 <p>The lower the sensitivity, the less noise that affects the image. The shutter speed will be slower in low light conditions.</p> <p>Higher sensitivity settings use faster shutter speeds in low light conditions to reduce camera shake, but the image may be affected by noise.</p>
200	
400	
800	
1600	
3200	
6400	

1 Use the four-way controller (▲▼) to select [Sensitivity] in the [📷 Rec. Mode] menu.

2 Press the four-way controller (▶).
A pull-down menu appears.

3 Use the four-way controller (▲▼) to change the sensitivity.

4 Press the OK button.
The setting is saved.



- The sensitivity cannot be changed in some shooting modes. Refer to "Functions Available for Each Shooting Mode" (p.172) for details.
- When the shooting mode is set to 📄 (Report), the AUTO sensitivity range is fixed at 125-6400.
- When [Pixel Track SR] is set to (On), 3200 and 6400 cannot be selected.

Saving the Sensitivity setting  p.108

Setting AUTO ISO Range

Set the sensitivity range when the sensitivity is set to AUTO.

The sensitivity can be set to 125-200, 125-400, 125-800, 125-1600, 125-3200, 125-6400.

- 1** Use the four-way controller (▲▼) to select [AUTO ISO Range] in the [📷 Rec. Mode] menu.
- 2** Press the four-way controller (▶).
A pull-down menu appears.
- 3** Use the four-way controller (▲▼) to select the sensitivity adjustment range.
- 4** Press the OK button.
The setting is saved.



- The selectable sensitivity range differs depending on the selected shooting mode. Refer to “Functions Available for Each Shooting Mode” (p.172) for details.
- When [Pixel Track SR] is set to (On), 125-3200 and 125-6400 cannot be selected.

Setting the Exposure (EV Compensation)

You can adjust the overall brightness of the picture.

Use this function to take pictures that are intentionally overexposed or underexposed.

- 1** Use the four-way controller (▲▼) to select [EV Compensation] in the [📷 Rec. Mode] menu.
- 2** Use the four-way controller (◀▶) to select the exposure compensation value.
To brighten, select a positive (+) value. To darken, select a negative (–) value. You can choose the compensation value in the range of –2.0 EV to +2.0 EV in 1/3 EV steps.



- When a histogram is displayed in Still Picture Capture Mode or playback mode, you can check whether the exposure is correct (p.27).
- EV Compensation cannot be used in some shooting modes. Refer to “Functions Available for Each Shooting Mode” (p.172) for details.

Saving the EV Compensation setting p.108

Correcting the Brightness (D-Range Setting)

Expands the dynamic range and prevents bright and dark areas from occurring. [Highlight Correction] adjusts the bright areas when the image is too bright and [Shadow Correction] adjusts the dark areas when the image is too dark.

Auto	The camera corrects the bright/dark areas automatically as necessary.
Off	The camera does not correct the bright/dark areas.

1 Use the four-way controller (▲▼) to select [D-Range Setting] in the [📷 Rec. Mode] menu.

2 Press the four-way controller (▶).
The [D-Range Setting] screen appears.

3 Use the four-way controller (▲▼) to select [Highlight Correction] or [Shadow Correction].

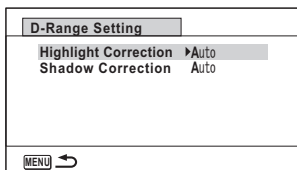

4 Press the four-way controller (▶).
A pull-down menu appears.

5 Use the four-way controller (▲▼) to change the setting.

6 Press the OK button.

The setting is saved.
The D-Range Setting icon appears on the display.



	When [Highlight Correction] is set to [Auto]
	When [Shadow Correction] is set to [Auto]
	When both [Highlight Correction] and [Shadow Correction] are set to [Auto]



If you change the [Highlight Correction] or [Shadow Correction] setting frequently, you can save time by assigning it to the Green button (p.92).



The D-Range setting cannot be set in some shooting modes. Refer to "Functions Available for Each Shooting Mode" (p.172) for details.

Setting Pixel Track SR

You can set this function to correct for camera shake when taking still shots. If Pixel Track SR is set to (On), the camera automatically corrects for camera shake in the images you shot. The default setting is (Off).



Shake reduction settings in (Movie) and (Underwater Movie) mode are configured under Movie SR (p.103).

3

1 Use the four-way controller () to select [Pixel Track SR] in the [Rec. Mode] menu.

2 Use the four-way controller () to switch between (On) or (Off).

- (On) Automatically corrects for camera shake.
- (Off) No correction for camera shake.

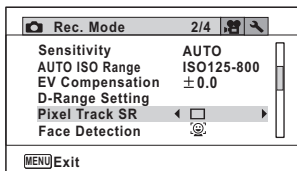

The setting is saved.

3 Press the **MENU** button.

The camera returns to capture mode.









- In (Green), (Movie), (Underwater Movie), and (Fireworks) modes, the Pixel Track SR is fixed at (Off).
- Pixel Track SR does not function when the flash discharges even if [Pixel Track SR] is set to (On).





The Pixel Track SR may not be effective when the shutter speed is slow. We recommend you turn off the [Pixel Track SR] setting (Off) and use a tripod for slow shutter speeds.

Switching the Face Detection Function

The Face Detection function locates faces in the frame and automatically adjusts the focus and exposure for those faces. You can change the setting of the function so that the camera will automatically release the shutter when one or more of the subjects smile. The default setting is  (Face Detection On).

 (Face Detection On)	The camera detects a person's face.
 (Smile Capture)	The camera automatically release the shutter when your subject smiles.
 (Self-portrait Assist)	The LED Macro Lights flash when the camera detects a person's face. The position of the blinking LED Macro Light indicates where the detected face is on the screen.
 (Self-portrait Assist + Smile Capture)	The LED Macro Lights flash when the camera detects a person's face. The camera automatically release the shutter when your subject smiles.
 (Face Detection Off)	The camera does not detect a person's face.

1 Use the four-way controller ( ) to select **[Face Detection]** in the **[Rec. Mode]** menu.

2 Press the four-way controller ().
A pull-down menu appears.

3 Use the four-way controller ( ) to change the setting.

4 Press the **OK** button.



The setting is saved.

The Face Detection icon appears on the display.



- Face Detection AF and AE may not work if the subject is wearing sunglasses, has part of their face covered or is not looking toward the camera.
- If the camera cannot detect the subject's face, the camera focuses with the setting currently selected in [Focusing Area].
- Even when Smile Capture is selected, it may not work and an image may not be captured, depending on the condition of the recognized faces, such as the faces are too small. If this happens, press the shutter release button to take a picture.
- In  (Pet) mode, the Face Detection function serves as the pet detection function (for one pet only).
- The Face Detection function cannot be selected in some shooting modes. Refer to "Functions Available for Each Shooting Mode" (p.172) for details.

To Use the Self-portrait Assist Function

The LED Macro Lights around the lens blink when the camera detects people's faces in  (Self-portrait Assist) or  (Self-portrait Assist + Smile Capture) mode. The position of the blinking LED Macro Light indicates where the detected face is on the screen.

The position (area) of the detected face corresponds to the blinking LED Macro Light as follows.

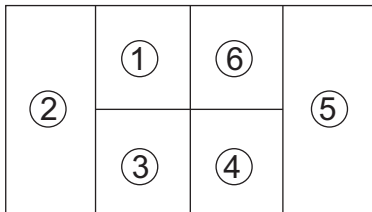
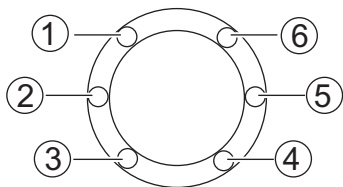

Example 1. When the camera detects a person in area ① on the display.

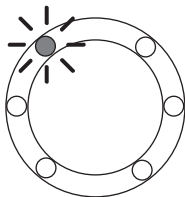

Example 2. When the camera detects two people in areas ② and ⑤ on the display.

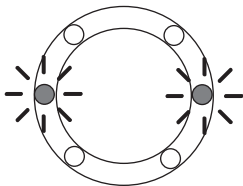



- When the camera detects two faces in the same area, the closest LED Macro Light to the blinking light also blinks.
- The camera can tell the positions of up to three detected faces by blinking the LED Macro Lights.
- When the camera detects three faces in area ②, LED ① to ③ blink.
- When the camera detects three faces in area ⑤, LED ④ to ⑥ blink.
- When the camera detects four or five faces, four or five LED Macro Lights blink depending on the number of detected faces. When the camera detects six or more faces, all the six lights blink (the lights do not tell the positions of detected faces).
- In (Auto Picture) mode, the LED Macro Lights turn off if the camera selects a mode in which the Face Detection function does not work after pressing the shutter release button halfway.
- When the Self-portrait Assist function is on, the LED Macro Lights do not turn off after the set period of Power Saving.
- The LED Macro Lights do not blink when the detected faces are too small.

Setting the Blink Detection Function

This specifies whether Blink Detection works when you use the Face Detection function. The default setting is (On).

1 Use the four-way controller (▲▼) to select [Blink Detection] in the [Rec. Mode] menu.

2 Use the four-way controller (◀▶) to switch between (On) or (Off).

(On) The Blink Detection function works.

(Off) The Blink Detection function does not work.

The setting is saved.

Blink Detection p.57



If the Blink Detection function detected closed eyes when shooting, [Closed eyes have been detected] is displayed for 3 seconds during Instant Review.

Setting the Instant Review

Use this setting to specify whether or not an Instant Review is displayed immediately after images are shot. The default setting is (On: displays the image).

1 Use the four-way controller (▲▼) to select [Instant Review] in the [Rec. Mode] menu.

2 Use the four-way controller (◀▶) to switch between (On) or (Off).

- (On) Instant Review is displayed.
 - (Off) Instant Review is not displayed.
- The setting is saved.

Instant Review p.57

Setting the Green Button Function

You can assign one of the following functions to the Green button: [Green Mode] (p.64) or [Fn Setting] (p.93). You can activate the assigned function by just pressing the Green button.



When the shooting mode is set to (Green) mode, the Green Button setting from the [Rec. Mode] menu is disabled. Switch to a mode other than to access [Green Button] in the [Rec. Mode] menu.

Assigning a Function to the Green Button

1 Use the four-way controller (▲▼) to select [Green Button] in the [Rec. Mode] menu.

2 Press the four-way controller (▶).
A pull-down menu appears.

3 Use the four-way controller (▲▼) to select a function you want to assign.

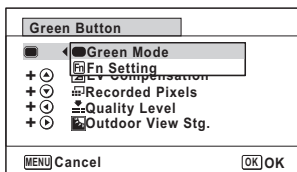

4 Press the OK button.
The setting is saved.



[Green Mode] is assigned to the Green button as the default setting.

Assigning Frequently Used Functions to the Four-way Controller (Fn Setting)

You can assign frequently used functions on the four-way controller. Using this function, you can directly set the functions by pressing the four-way controller without displaying the menu in capture mode.

In [Fn Setting], Still Picture Capture Mode and Movie Mode have different settings. To execute [Fn Setting] in Movie Mode, press the **MENU** button in Movie Mode and use the four-way controller (◀▶) to display the [📷 Rec. Mode] menu before step 1 on p.92.

3 Use the four-way controller (▲▼) to select [Fn Setting].

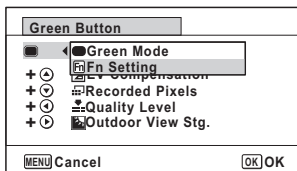

4 Press the OK button.

The [Fn Setting] screen appears.

5 Use the four-way controller (▲▼) to select a key you want to assign a function to.

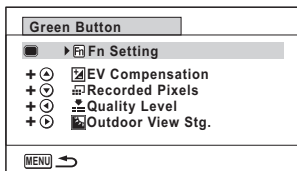

6 Press the four-way controller (▶).

A pull-down menu appears.

7 Use the four-way controller (▲▼) to select an item you want to assign.

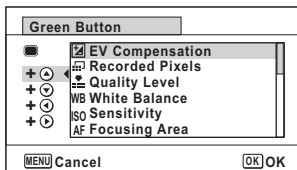

8 Press the OK button.

The setting is saved.



The functions assigned to the keys of the four-way controller can be used only when [Fn Setting] is assigned to the Green button.



You can assign only one function to each key.

The default settings for each mode

	Still Picture Capture Mode	Movie mode
Default settings	(▲) EV Compensation	(▲) Movie SR
	(▼) Recorded Pixels	(▼) EV Compensation
	(◀) Quality Level	(◀) Recorded Pixels
	(▶) Outdoor View Stg.	(▶) Outdoor View Stg.

3

Taking Pictures

Items that can be assigned to each key

	Still Picture Capture Mode	Movie mode
Selectable items	EV Compensation	Recorded Pixels
	Recorded Pixels	Movie SR
	Quality Level	White Balance
	White Balance	Focusing Area
	Sensitivity	Face Detection
	Focusing Area	EV Compensation
	Face Detection	Sharpness
	Auto Macro	Saturation (Tone Adjustment) *
	AE Metering	Contrast
	Highlight Correction	Outdoor View Stg.
	Shadow Correction	
	Sharpness	
	Saturation (Tone Adjustment) *	
	Contrast	
Outdoor View Stg.		

* The menu item to be displayed changes depending on the [Image Tone] selected in the [📷 Rec. Mode] menu. When you have selected any one of [Bright], [Natural], [Vibrant], or [Slide Film], [Saturation] is displayed, and when [Monochrome] is selected, [Tone Adjustment] is displayed.

Changing Assigned Items

Press the Green button in capture mode to display the Fn Setting screen. Select an item with the four-way controller (▲▼◀▶), and press either the (▲▼) or (◀▶) four-way controller to change the settings.

Setting the Image Sharpness (Sharpness)

You can give an image sharp or soft outlines.

- 1 Use the four-way controller (▲▼) to select [Sharpness] in the [📷 Rec. Mode] menu.
- 2 Use the four-way controller (◀▶) to change the sharpness level.
 Soft
Normal
Sharp

Setting the Saturation/Tone Adjustment

You can set either color brightness (Saturation) or the tone of monochrome images (Tone Adjustment).

The menu item to be displayed changes depending on the [Image Tone] selected in the [📷 Rec. Mode] menu.

Selected Image Tone	Displayed item
Bright, Natural, Vibrant, Slide Film*	Saturation
Monochrome	Tone Adjustment

* cannot select the level (fixed to Normal)

- 1 Use the four-way controller (▲▼) to select [Saturation (or Tone Adjustment)] in the [📷 Rec. Mode] menu.
- 2 Use the four-way controller (◀▶) to select the level of saturation (or color tone for Tone Adjustment).
 Low (Blue for Tone Adjustment)
Normal (B&W for Tone Adjustment)
High (Sepia for Tone Adjustment)

Setting the Image Contrast (Contrast)

For setting the image contrast level.

- 1 Use the four-way controller (▲▼) to select [Contrast] in the [📷 Rec. Mode] menu.
- 2 Use the four-way controller (◀▶) to change the contrast level.
 Low
Normal
High

Setting the Date Imprint Function

You can choose whether to imprint the date and/or time when taking still pictures.

- 1 Use the four-way controller (▲▼) to select [Date Imprint] on the [📷 Rec. Mode] menu.
- 2 Press the four-way controller (▶).
A pull-down menu appears.
- 3 Use the four-way controller (▲▼) to select the Date Imprint details.
Choose from [Date], [Date & Time], [Time] or [Off].
- 4 Press the OK button.
The setting is saved.



- The date and/or time imprinted with the Date Imprint function cannot be deleted.
- Note that if a printer or image editing software is set to print the date and the images to be printed already have the date and/or time imprinted, the imprinted dates and/or times may overlap.



- **DATE** appears on the display in 📷 mode when [Date Imprint] is set to any setting other than [Off].
- The date and/or time are imprinted on the picture with the display format set in the [Date Adjustment] screen (p.41).

Setting the IQ Enhancer Processing

You can take pictures with clearer details by using image processing with the IQ Enhancer technique.



- 1 Use the four-way controller (▲▼) to select [IQ Enhancer] in the [📷 Rec. Mode] menu.
- 2 Use the four-way controller (◀▶) to select (On)/ (Off).
 (On) The IQ Enhancer function works
 (Off) The IQ Enhancer function does not work
 The setting is saved.



IQ Enhancer does not function in the following situations:

- When the drive mode is set to 📷 (Burst Shooting)
- When the shooting mode is set to 📷 (Digital SR)

Setting the Macro Light

Set whether or not to turn on the LED Macro Lights around the lens. The LED Macro Lights turn on when the [Macro Light] is set to  (On), and then you can use [Brightness] to adjust the brightness. The default setting is  (On), and Brightness is 1.

1 Use the four-way controller (▲▼) to select [Macro Light] in the [Rec. Mode] menu.

The Macro Lights menu appears.

2 Press the four-way controller (▶).

A pull-down menu appears.



3 Use the four-way controller (◀▶) to select (On)/ (Off).

- (On) Turns on the LED Macro Lights
- (Off) Turns off the LED Macro Lights





4 Use the four-way controller (▼) to select Brightness, and then adjust brightness by four-way controller (◀▶).

The setting is saved.



- The LED does not light even if the LED Macro Light is turned on unless the Macro Light is set in Flash Mode.
- The shooting modes that is able to select the Macro Light in Flash Mode are Program, Movie, Report and Digital Microscope. (The macro light setting is fixed for Digital Microscope.)
- The LED Macro Lights turn off during playback and when using the USB connector.
-  (Self-portrait Assist) and  (Self-portrait Assist + Smile Capture) cannot be selected when [Macro Light] is set to  (On).







If you take a picture using the self-timer (, ) or a remote control unit (, ) while [Macro Light] is set to  (On), the LED Macro Lights remain on regardless of the countdown.

Underwater Shooting



Underwater Shooting (Underwater Mode/ Underwater Movie Mode)

This camera complies with JIS waterproof grade 8 and can be used to take pictures at a depth of 14 meters continuously for 2 hours. In addition, this camera complies with JIS dustproof grade 6 (IP68).

	Use the Underwater mode to take underwater still pictures that capture the blueness of the sea.
	Use the Underwater Movie mode to record movies underwater.

1 Use the four-way controller (▲▼◀▶) to select  (Underwater)/  (Underwater Movie) from the Capture Mode Palette.

2 Press the OK button.
The shooting mode is selected and the camera returns to capture mode.

3 Press the shutter release button fully.
If you selected , a still picture is taken.
If you selected , movie recording starts. You can continue recording until the recorded movie time reaches 25 minutes. To stop recording, press the shutter release button fully again. An underwater movie can be recorded in the same way as  (Movie) mode.



Recording Movies  p.100



- Before shooting underwater, make sure that there is no dirt or sand on the waterproof seal of the battery/card and terminal covers and check that the covers are securely locked.
- Before opening the battery/card and terminal covers after using the camera underwater, make sure that there is no water, dirt, or sand on the covers or anywhere else on the camera. Wipe the camera before opening the covers.
- When shooting in  (Underwater Movie) mode, use SD Speed Class 4 or higher cards.

Regarding Waterproof, Dustproof, and Shockproof Design  p.8



- If the focus mode is set to **MF** in  mode, you can adjust the focus before recording starts and during recording.
- The optical zoom and digital zoom can be used in  mode before recording starts. The digital zoom can also be used during recording.
- Movies recorded in  mode capture a different area than still pictures.

Although the camera is designed to be waterproof and dustproof, avoid using the camera under the following conditions. It may momentarily be subjected to water pressure beyond that covered in the guarantee and water may enter the interior of the camera.

- Jumping into the water while holding the camera
- Swimming while holding the camera in your hand
- Using the camera in environments where water is applied forcefully, such as strong river currents and waterfalls

Recording Movies

Recording Movies

This mode enables you to record movies. Sound is recorded at the same time.

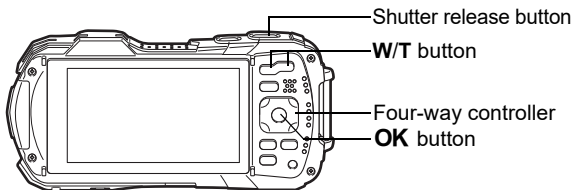

1 Use the four-way controller (▲▼◀▶) to select  (Movie) from the Capture Mode Palette.

2 Press the OK button.

The  (Movie) mode is selected and the camera returns to capture mode.

The following information appears on the display.

- 1 Movie mode icon
- 2 Movie Shake Reduction icon
- 3 Remaining recordable time
- 4 REC indicator (blinks during recording)
- 5 Focus frame (does not appear during recording)

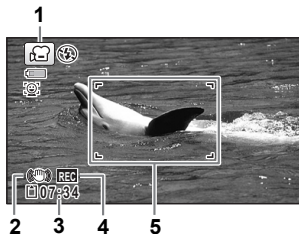

You can change the captured area by pressing the **W/T** button.

T Enlarges the subject.

W Widens the area that is captured by the camera.

3 Press the shutter release button fully.



Recording starts. You can continue recording until the recorded movie time reaches 25 minutes.

4 Press the shutter release button fully.

Recording stops.

Playing Back a Movie  p.111



- The focus mode can be changed before recording starts.
- When the focus mode is set to **MF** (Manual Focus), you can adjust the focus before recording starts and during recording.
- When the shooting mode is set to  (Movie), Face Detection is automatically set to on. You can select Smile Capture or Face Detection Off before starting recording a movie (p.89). When the Smile Capture function is activated, movie recording starts automatically when the camera recognizes the subject's smile. However, the Smile Capture function may not work depending on the condition of the recognized faces, and movie recording may not start automatically. If this happens, press the shutter release button to start movie recording.
- You can record a movie using a remote control unit (optional) (p.70).
- When you use the SD Memory Card, use SD Speed Class 4 or higher cards.
- Movies recorded in  mode capture a different area than still pictures.

Keeping the Shutter Release Button Pressed

If you keep the shutter release button pressed for more than one second, recording will continue as long as you keep the button pressed. Shooting stops when you take your finger off the shutter release button.

Recording a Movie Quickly Using the Movie Button

This camera starts/stops movie recording simply by pressing the Movie button, without selecting  (Movie) from the Capture Mode Palette. This is useful when you want to start recording quickly.

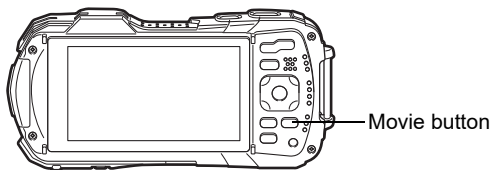

1 Press the Movie button.

Recording starts. You can continue recording until the recorded movie time reaches 25 minutes.

2

Press the Movie button again.

Recording stops.



- You cannot stop recording by pressing the shutter release button. To stop recording, press the Movie button.
- You cannot start recording a movie by pressing the Movie button when the shooting mode is set to (Movie), (Underwater Movie), (Digital Microscope), (Interval Shot), (High Speed Movie), (Interval Movie), or (Pet), or the camera is in mode.
- Movies are recorded with the default settings for the [Movie] menu when recording movies with the Movie button (p.181).

3

Selecting the Number of Recorded Pixels and Frame Rate for Movies

You can choose the number of recorded pixels and frame rate settings for movies. The more pixels there are, the clearer the details and the bigger the file size. The more frames per second, the better the quality of the movie, but the file size becomes larger.

Setting	Recorded Pixels	Frame Rate	Use
	1920 x 1080	30 fps	Records images in full HDTV format (16:9). Movement is recorded smoothly. (default setting)
	1280 x 720	60 fps	Records images in HDTV format (16:9). Quick movement is recorded smoothly.
	1280 x 720	30 fps	Records images in HDTV format (16:9). Movement is recorded smoothly.

* The frame rate (fps) indicates the number of frames per second.

1

Use the four-way controller (▲ ▼) to select [Recorded Pixels] in the [Movie] menu.

2

Press the four-way controller (▶).

A pull-down menu appears.

- 3** Use the four-way controller (▲▼) to change the number of recorded pixels and frame rate.

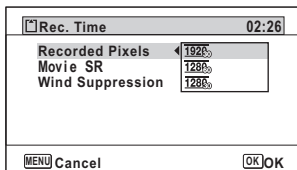

- 4** Press the OK button.

The setting is saved.



Due to the following restriction, the actual recordable time may differ from the recordable time (Rec. Time) that appears in the top-right corner of the screen.

- The maximum recordable time of a file is 25 minutes.

Setting the Movie SR (Movie Shake Reduction) Function

In (Movie) and (Underwater Movie) modes, you can correct camera shake while you are recording a movie with the Movie SR (Movie Shake Reduction) function.

The default setting is (On).

- 1** Use the four-way controller (▲▼) to select [Movie SR] in the [Movie] menu.

- 2** Use the four-way controller (◀▶) to select (On) or (Off).

- (On) Automatically corrects camera shake.
- (Off) Does not correct camera shake.

The setting is saved.

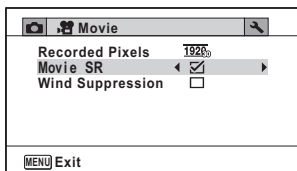

Suppressing Wind Noises during Movie Recording (Wind Suppression)

You can reduce wind noises during movie recording.
The default setting is (Off).

1 Use the four-way controller (▲▼) to select [Wind Suppression] in the [Movie] menu.

2 Use the four-way controller (◀▶) to select (On)/ (Off).

- (On) Suppresses wind noises.
- (Off) Does not suppress wind noises.

The setting is saved.

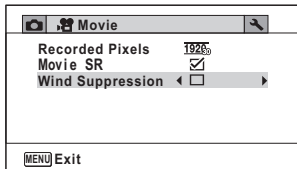

Combining Pictures Taken at a Set Interval into a Movie (Interval Movie)

In this mode, you can record multiple still pictures taken automatically at a set interval from a set time, as a movie file.

Interval	Set the shooting interval to 1 minute, 5 minutes, 10 minutes, 30 minutes, or 1 hour.
Total Time	Set the total time, from 10 minutes to 359 hours. The total time and the time unit change depending on the interval set. The total time can be set in increments of 1 minute, 5 minutes, 10 minutes, 30 minutes, or 1 hour.
Start Delay	Set the start delay, from 0 minutes to 24 hours. You can set this in 1-minute increments. If the start time is set to 0 minutes, the first picture is taken as soon as the shutter release button is pressed.

1 Use the four-way controller (▲▼◀▶) to select [Interval Movie] from the Capture Mode Palette.

2 Press the OK button.

The current Interval Movie settings appear for approximately one minute. To take pictures with the current settings, go to step 10.

3 Press the OK button while the current settings are displayed.

The Interval Movie setting screen appears. [Interval] is marked with the frame.

4 Set the interval.

1 Press the four-way controller (▶).

A pull-down menu appears.

2 Use the four-way controller (▲▼) to set the interval, then press the OK button.

The frame returns to [Interval].

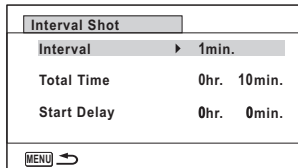

5 Press the four-way controller (▼).

The frame moves to [Total Time].

6 Set the total time.

1 Press the four-way controller (▶).

2 Use the four-way controller (▲▼) to set the hours, then press the four-way controller (▶).

3 Use the four-way controller (▲▼) to set the minutes, then press the four-way controller (▶).

The frame returns to [Total Time].

7 Press the four-way controller (▼).

The frame moves to [Start Delay].

8 Set the start delay.

1 Press the four-way controller (▶).

2 Use the four-way controller (▲▼) to set the hours, then press the four-way controller (▶).

3 Use the four-way controller (▲▼) to set the minutes, then press the four-way controller (▶).

The frame returns to [Start Delay].

9 Press the MENU button.

The Interval Movie settings are saved and the camera returns to capture mode.

10 Press the shutter release button to take a picture.

Interval movie recording starts.

The LCD turns off between shots (during standby). Press the power button during standby to display the remaining time and shooting interval on the screen.

The [Stop interval shooting?] message is displayed when the power button and then the **MENU** button are pressed during standby. Pressing the **OK** button cancels interval movie recording.



- Confirm that the battery is sufficiently charged before starting interval movie recording. If the battery is not sufficiently charged, it may become depleted during interval movie recording and cause recording of the movie to stop.
- For interval movie recording, the following settings are fixed. Recorded Pixels: 1920, Frame Rate: 30 fps, Quality Level: ★★★, Movie SR: (Off), and Flash Mode:
- Interval movie recording stops if the SD Memory Card is removed or inserted during standby.
- Sound cannot be recorded during interval movie recording.
- When you use the SD Memory Card, use SD Speed Class 4 or higher cards.

3



- If you set a start delay, a start time corresponding to the current time and the start delay you set is displayed in real time.
- The total time you can set differs according to the shooting interval you set, as indicated in the table below.

Interval	Total time that can be set
	30 fps
1 min.	10 minutes to 5 hours and 59 minutes (in increments of 1 minute)
5 min.	30 minutes to 29 hours and 55 minutes (in increments of 5 minutes)
10 min.	1 hour to 59 hours and 50 minutes (in increments of 10 minutes)
30 min.	3 hours to 179 hours and 30 minutes (in increments of 30 minutes)
1 hr.	6 hours to 359 hours (in increments of 1 hour)

- The Date Imprint function (p.96) is available for Interval Movie mode.

Using the High Speed Movie Function

The camera records a high speed movie for slow motion playback.

1 Use the four-way controller (▲▼◀▶) to select  (High Speed Movie) from the Capture Mode Palette.



2 Press the OK button.
The camera returns to capture mode.



3 Press the shutter release button fully.
Recording starts. You can continue recording until the recorded movie time reaches 15 seconds per file.

4 Press the shutter release button fully again.
Recording stops.



- In this mode, a movie is recorded at 120 fps and played back at 30 fps.
- The recorded pixels is fixed to 1280 x 720.
- The flash does not discharge in this mode.
- The Movie SR is fixed to (Off).
- When you use the SD Memory Card, use SD Speed Class 4 or higher cards.
- Zoom is not available during recording.
-  (Self-portrait Assist) and  (Self-portrait Assist + Smile Capture) are not available.

Saving the Settings (Memory)

The Memory function is for saving the current camera settings when the camera is turned off.

For some camera settings, the Memory function is always set to (On) (the settings are saved when the camera is turned off), while for others you can choose or (Off) (to choose whether the settings are saved or not when the camera is turned off). The items which can be set to or in the Memory function are shown in the table below. (Items not listed here are always saved in the selected settings when the camera is turned off.)

If you select , the settings will be saved in the status they were in immediately before the camera was turned off. If you select , the settings will be reset to the defaults when the camera is turned off. The table below also shows whether the Memory default setting for each item is or .

Item	Description	Default setting	Page
Face Detection	The [Face Detection] setting in the [📷 Rec. Mode] menu	<input type="checkbox"/>	p.89
Flash Mode	The flash mode set with the four-way controller (◀)	<input checked="" type="checkbox"/>	p.73
Drive Mode	The drive mode set with the four-way controller (▲)	<input type="checkbox"/>	p.67 - p.71
Focus Mode	The focus mode set with the four-way controller (▶)	<input type="checkbox"/>	p.75
Zoom Position	The zoom position set with the W/T button.	<input type="checkbox"/>	p.57
MF Position	The manual focus position set with the four-way controller (▲▼)	<input type="checkbox"/>	p.76
White Balance	The [White Balance] setting in the [📷 Rec. Mode] menu	<input type="checkbox"/>	p.82
Sensitivity	The [Sensitivity] setting in the [📷 Rec. Mode] menu	<input type="checkbox"/>	p.85
EV Compensation	The [EV Compensation] setting in the [📷 Rec. Mode] menu	<input type="checkbox"/>	p.86
AE Metering	The [AE Metering] setting in the [📷 Rec. Mode] menu	<input type="checkbox"/>	p.84
Digital Zoom	The [Digital Zoom] setting in the [📷 Rec. Mode] menu	<input checked="" type="checkbox"/>	p.59
DISPLAY	The information display mode set with the OK button	<input type="checkbox"/>	p.21
File No.	If a new SD Memory Card is inserted when set to <input checked="" type="checkbox"/> (On), file numbers are assigned sequentially.	<input checked="" type="checkbox"/>	—

1 Use the four-way controller (▲▼) to select [Memory] in the [📷 Rec. Mode] menu.

2 Press the four-way controller (▶).

The [Memory] screen appears.

3 Use the four-way controller (▲▼) to choose an item.

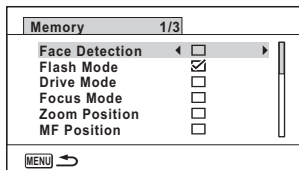

4 Use the four-way controller (◀▶) to select (On) or (Off).

Playing Back Images

Playing Back Still Pictures

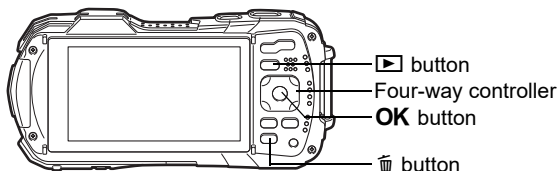

4

Playing Back and Deleting Images

1 Press the ▶ button after taking a picture.

The camera enters ▶ mode and the image appears on the display. Displaying one image in full in ▶ mode (default setting) is called single-image display.

File number



To Play Back the Previous or Next Image

2 Press the four-way controller (◀▶).

The previous or next image appears.

To Delete the Displayed Image

Press the 🗑 button while the image is displayed to display the Delete screen. Press the four-way controller (▲) to select [Delete] and press the OK button.

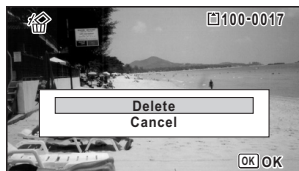

For information on other deletion procedures p.121

Playing Back a Movie

You can play back the movies you have taken. The sound is played back at the same time.

1 Enter  mode and use the four-way controller (◀▶) to choose the movie you want to play back.

2 Press the four-way controller (▲).

Playback starts.



The following operations can be performed during playback.

Four-way controller (▲)	Pauses playback
Zoom button right (Q)	Increases the volume
Zoom button left (E)	Reduces the volume
Press and hold the four-way controller (▶)	Fast-forwards playback
Press and hold the four-way controller (◀)	Fast-reverses playback

The following operations can be performed while playback is paused.

Four-way controller (◀)	Reverses frames(*)
Four-way controller (▶)	Forwards frames
Four-way controller (▲)	Resumes playback

(*) In frame-reverse mode, the first frame of every 30 frames appears on the display with each press of the four-way controller (◀). For example, when you reverse frames from the second frame to the 31st frame, the first frame appears on the display, and when you reverse frames from the 32nd to 61st, the 31st frame appears.

3 Press the four-way controller (▼).

Playback stops.



Only movies taken with this camera can be played back. Movies taken with other cameras cannot be played back.

Multi-Image Display











6-Image Display/12-Image Display

You can display 6 or 12 thumbnails of captured images at a time.

1 Press the button in mode.

The 6-image display appears showing a page consisting of 6 thumbnail images. Pressing the  button again changes it to a 12-image display.

A page consisting of 6 or 12 thumbnail images appears. The displayed images change 6 or 12 images at a time page by page.

Use the four-way controller () to move the frame. If there are too many images to display on one page, pressing the four-way controller () while the image  is selected will display the previous page. Similarly, if you choose the image  and press the four-way controller () , the next page appears.

◆ indicates that the previous or next screen is stored in a separate folder.

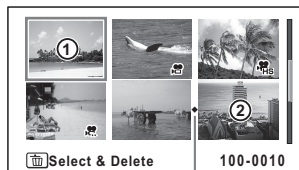



6-Image Display

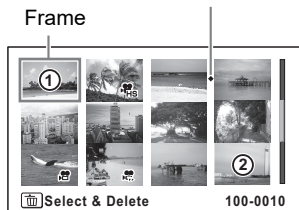

Folder divider icon



12-Image Display

The icons that appear on the images indicate the following:

(No icon)	Still picture
	Movie (the first frame appears)
	High Speed Movie (the first frame appears)

Press the **OK** button to switch to single-image display of the selected image.
Press the  button to switch to  mode.

Folder Display/Calendar Display

Press the  button in 12-image display to switch to folder or calendar display.
Press the Green button to switch between folder display and calendar display.

1 Press the button twice in mode.





The screen changes to 12-image display.

2 Press the button.

The screen changes to folder display or calendar display.

Folder display

The list of folders with recorded images appears.

Use the four-way controller () to move the frame.

If you select a folder and press the  button or the **OK** button, the images in the selected folder are displayed in 12-image display.

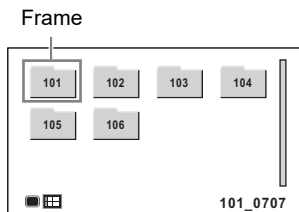

Calendar display

Stored images are displayed by date in calendar format.

The first image captured on a date is displayed for that date on the calendar. Use the four-way controller (▲▼◀▶) to move the frame.

If you select a date and press the **Q** button, the images captured on that date are displayed in 12-image display.

Select a date and press the **OK** button to switch to single-image display of the first image captured on that date.

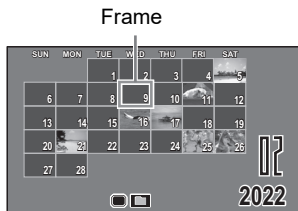

- Press the **MENU** button in folder display or calendar display to switch to 12-image display.
- Press the **▶** button or press the shutter release button halfway in folder display or calendar display to switch to **📷** mode.

4

Using the Playback Functions

- 1 In **▶** mode, press the four-way controller (▼).

The Playback Mode Palette appears.

- 2 Use the four-way controller (▲▼◀▶) to choose an icon.

The guide for the selected function appears below.

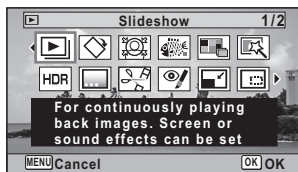

- 3 Press the **OK** button.

The playback function is recalled.

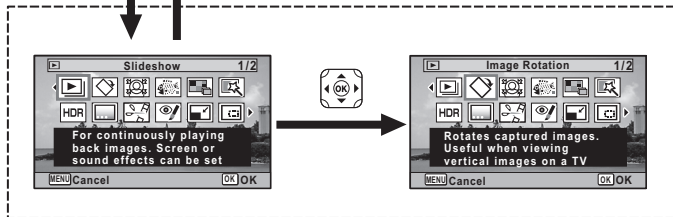
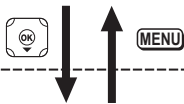

Press **(SHUTTER)** halfway
or **(▶)**

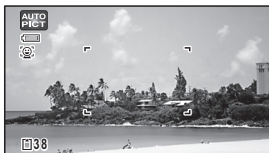

Closes the Playback Mode Palette and goes to **(CAMERA)** mode

(OK)

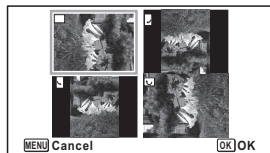















Goes to the screen for selected playback function













- When the frame is placed over an icon on the Playback Mode Palette, the guide of that function appears.
- You can set the guide of the function not to display on the Playback Mode Palette (p.163).

Playback Mode Palette

Playback Mode		Description	Page
	Slideshow	For continuously playing back images. Screen or sound effects can be set	p.117
	Image Rotation	Rotates captured images. Useful when viewing vertical images on a TV	p.119
	Small Face Filter	Reduces the size of faces in the image, for well-proportioned portraits	p.130
	Ink Rubbing Filter	Creates an image similar to ink rubbing from original pictures	p.133
	Collage	Creates a collage print page from saved image files	p.134
	Digital Filter	For modifying images with a Color filter or Soft filter	p.131
	HDR Filter	Processes single image to simulate HDR effect	p.133
	Original Frame	Available to make from the kind and color of a frame. Available to enter text	p.138
	Movie Edit	Save as Still Image	p.142
		Divide Movies	
		Adding title picture	
	Red-eye Edit	Attempts to edit out the red-eye effect in image. Success may vary	p.137
	Resize	Changes Recorded Pixels and Quality Level to make the file size smaller	p.128
	Cropping	For cropping images to the size you like. Saved as a new image	p.129
	Image Copy	To copy images between the built-in memory and an SD Memory Card	p.145
	Protect	Protects images from delete function. Format function still erases all	p.124
	Start-up Screen	For setting a captured image as the Start-up Screen	p.164

Slideshow

You can play back recorded still pictures and movies one after another.

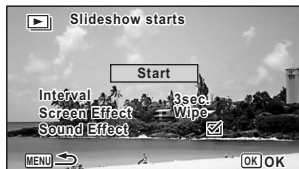

- 1** Enter  mode and use the four-way controller ( ) to choose the image to start the slideshow with.
- 2** Use the four-way controller (   ) to select  (Slideshow) from the Playback Mode Palette.
- 3** Press the OK button.
The slideshow setting screen appears.
- 4** Use the four-way controller ( ) to select [Start].





- 5** Press the OK button.
The slideshow starts.
Pressing the OK button during the slideshow pauses the slideshow. To resume the slideshow, press the OK button again.
- 6** Press any button other than the OK button.
The slideshow stops.

To Set the Slideshow Conditions

You can set the playback interval, a screen effect and sound effect for when one image changes to the next.

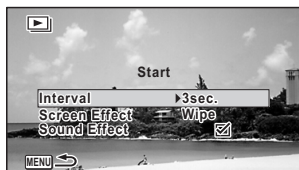
- 1** Use the four-way controller ( ) to select [Interval] in step 4 on p.117.



- 2** Press the four-way controller ().
A pull-down menu appears.

3

Use the four-way controller (▲▼) to change [Interval] and press the OK button.

Choose from [3sec.], [5sec.], [10sec.], [20sec.] or [30sec.].

4

Use the four-way controller (▲▼) to select [Screen Effect].

After selecting [Screen Effect], press the four-way controller (▶). A pull-down menu appears with the following items. Use the four-way controller (▲▼) to select an item and press the **OK** button.

Wipe	The next image slides over the previous one from left to right
Checker	The next image appears in small square mosaic blocks
Fade	The current image gradually fades out and the next image fades in
Random	Various effects are used randomly
Off	No effect

4

5

Use the four-way controller (▲▼) to select [Sound Effect].

6

Use the four-way controller (◀▶) to select (On) or (Off).

Except when the [Screen Effect] is set to [Off], you can choose (On) or (Off) for the sound that is played when one image changes to the next.

7

Use the four-way controller (▲▼) to select [Start].

8

Press the OK button.











The slideshow starts with the selected interval and effects.



- The slideshow will continue until you press any button other than the **OK** button.
- Movies will be played back through to the end before the next picture is displayed, regardless of the Interval setting. However, pressing the four-way controller (▶) while playing back a movie skips to the next image.
- When [Random] is selected for the screen effect, the interval is fixed to the setting selected in step 3 and the sound effect is set to off.

Connecting the Camera to an AV Device p.126

Rotating the Image

- 1 Press the  button after taking a picture.**
The image appears on the display.
- 2 Use the four-way controller (   ) to select  (Image Rotation) from the Playback Mode Palette.**
- 3 Press the OK button.**
The rotation selection screen (0°, Right 90°, Left 90°, or 180°) appears.
- 4 Use the four-way controller (   ) to choose the rotation direction and press the OK button.**

The rotated image is saved.

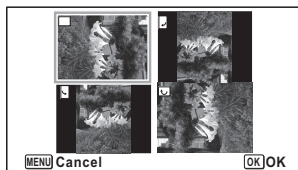



- Movies cannot be rotated.
- Protected images can be rotated, but they cannot be saved in a rotated state.

Zoom Playback

You can magnify an image up to ten times.

1 Enter  mode and use the four-way controller (◀▶) to choose the image you want to magnify.

2 Press the  button.

The image is magnified (x1.1 to x10). Holding down the  button continuously magnifies the image.



With [Quick Zoom] (p.162) set to (On), pressing  button once magnifies the image to 10x.

You can use the + mark of the guide at the bottom left of the screen to check which portion of the image is magnified.



Guide

The following operations can be performed while an image is magnified.

Four-way controller (▲▼◀▶)	Changes the position of the area to be magnified
Zoom button right ()	Makes the image bigger (max. of 10x)
Zoom button left ()	Makes the image smaller (min. of 1.1x)

3 Press the **OK** button.

The image returns to single-image display.



Movies cannot be magnified.

Deleting Images

Delete images that you do not want to keep.

Deleting a Single Image

You can delete a single image.



Protected images cannot be deleted (p.124).

1 Enter  mode and use the four-way controller (◀▶) to choose the image you want to delete.

2 Press the  button.
A confirmation screen appears.

3 Use the four-way controller (▲) to select [Delete].

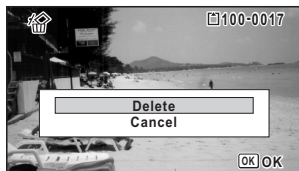

4 Press the OK button.
The image is deleted.

Deleting Selected Images

You can delete multiple images selected from the 6- or 12-image display at once.



Protected images cannot be deleted (p.124).

1 Press the button once or twice in mode.

6-image display or 12-image display appears.

2 Press the button.

appears on the images.

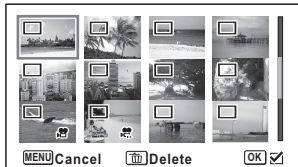

3 Use the four-way controller () to choose the images that you want to delete and press the OK button.

appears on the selected images.

Pressing and holding the button displays the selected image in single-image display and you can check whether to delete the image. Releasing the button returns to 6- or 12-image display. However, protected images cannot be displayed in single-image display.

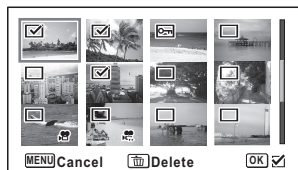

4 Press the button.

A confirmation screen appears.

5 Use the four-way controller () to select [Select & Delete].

6 Press the OK button.

The selected images are deleted.

Deleting All Images

Deletes all the images at once.



Protected images cannot be deleted (p.124).

1 Press the **MENU** button in mode.

The [Setting] menu appears.

When you press the **MENU** button in mode, press the four-way controller () once or twice.

2 Use the four-way controller () to select [Delete All].

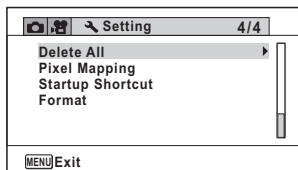

3 Press the four-way controller () to confirm.

A confirmation dialog appears.



4 Use the four-way controller () to select [Delete All].

5 Press the **OK** button.

All the images are deleted.

Protecting Images from Deletion (Protect)

You can protect stored images from being accidentally deleted.

- 1** Enter  mode and use the four-way controller (◀▶) to choose the image you want to protect.
- 2** Use the four-way controller (▲▼◀▶) to select  (Protect) from the Playback Mode Palette.

- 3** Press the OK button.

The screen for selecting [Single Image] or [All Images] appears.

- 4** Use the four-way controller (▲) to select [Single Image].



- 5** Press the OK button.

The message [Protects this image] appears.

To protect another image, use the four-way controller (◀▶) to select another image.

- 6** Use the four-way controller (▲) to select [Protect].

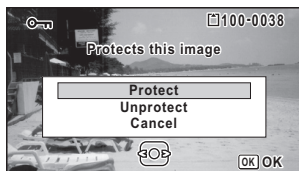

- 7** Press the OK button.

The selected image is protected.

To protect other images, repeat steps 4 to 7.

Select [Cancel] to exit the Protect setting.



- To cancel the protection of the image, select [Unprotect] in step 6.
-  appears on the protected images during playback.

To Protect All Images

- 1** Select [All Images] in step 4 on p.124.



- 2** Press the OK button.

- 3** Use the four-way controller (▲) to select [Protect].



- 4** Press the OK button.

All the images are protected and the screen shown in step 1 reappears.

- 5** Use the four-way controller (▲▼) to select [Cancel] and press the OK button.

The Playback Mode Palette reappears.



Protected images are deleted when the SD Memory Card or the built-in memory is formatted (p.148).



To cancel the protection of all your images, select [Unprotect] in step 3.

Connecting the Camera to an AV Device

You can connect the camera to a TV or other device with an HDMI terminal and playback images.



- The power lamp on the camera lights up during a connection.
- If you intend to use the camera continuously for a long period, use a battery with ample capacity remaining.
- The camera display turns off while the camera is connected to an AV device.
- You cannot adjust the volume on the camera when connected to an AV device. Adjust the volume on the AV device.
- When the camera is connected to an AV device, you can change the images displayed on the screen of the connected AV device with the remote control (optional).

4

Connecting the Camera to an HDMI Terminal

Use a commercially available HDMI cable to connect the camera to a device with an HDMI terminal.

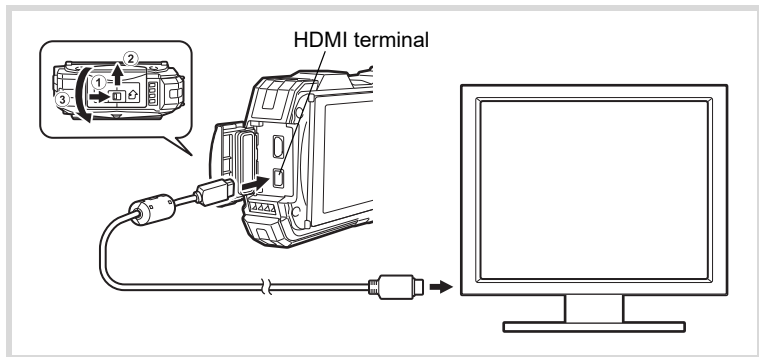

1 Turn the AV device and camera off.

2 Open the terminal cover.

Move the terminal cover lock lever in the direction shown by ①, slide the cover in the direction shown by ② and open the cover in the direction shown by ③.

3 Connect the HDMI cable to the HDMI terminal.

4 Connect the other end of the HDMI cable to the HDMI terminal on the AV device.

5 Turn the AV device and camera on.

The camera information is displayed on the screen of the connected AV device.



- The camera has a Type D (Micro) HDMI terminal. Use a commercially available HDMI cable that matches your AV device.
- If you play back movies by connecting the camera to an AV device with a commercially available HDMI cable, set the output format to "Selecting the HDMI Output Format" (p.160).



Close the terminal cover securely when not using the terminal.

<How to close the terminal cover>

Close the cover in the opposite direction indicated by ③. While lightly pressing on the terminal cover, slide it away from ② until it clicks.

Changing the Image Size (Resize)

By changing the recorded pixels and quality level of a selected image, you can make the file size smaller than the original. You can use this function to continue taking pictures when the SD Memory Card or the built-in memory is full, by making the images smaller and overwriting the original images to make more space available.



- Images taken with the recorded pixels of 12M or movies cannot be resized.
- You cannot select a larger resolution and higher quality level than that of the original image.

1 Enter mode and use the four-way controller (◀▶) to choose the image you want to resize.

2 Use the four-way controller (▲▼◀▶) to select (Resize) from the Playback Mode Palette.

3 Press the OK button.

The screen for choosing the recorded pixels and quality level appears.

4 Select [Recorded Pixels] and [Quality Level].

Use the four-way controller (◀▶) to choose the desired recorded pixels and quality level. Use the four-way controller (▲▼) to switch between [Recorded Pixels] and [Quality Level].



5 Press the OK button.

A confirmation dialog for overwriting the image appears.

If the selected image is protected, the processed image is saved as a new image and the confirmation dialog does not appear.

6 Use the four-way controller (▲▼) to select [Overwrite] or [Save as].

7 Press the OK button.

The resized image is saved.

Cropping Images

You can delete the unwanted part of a picture and save the cropped image as a separate image.



Images taken with the recorded pixels of 12M [REDACTED] or movies cannot be cropped.

- 1** Enter mode and use the four-way controller (◀▶) to choose the image you want to crop.
- 2** Use the four-way controller (▲▼◀▶) to select (Cropping) from the Playback Mode Palette.
- 3** Press the OK button.

The cropping screen appears.

The largest size of the cropped image is shown with a green frame on the screen. The cropped image cannot be larger than this cropping frame size.

- 4** Choose the cropping area.

The following operations specify the size and position of the cropping frame.

Zoom button (/Q)	Changes the size of the cropping frame
Four-way controller (▲▼◀▶)	Moves the cropping frame up, down, left and right
Green button	Rotates the cropping frame <ul style="list-style-type: none">The button is displayed only when the cropping frame can be rotated.

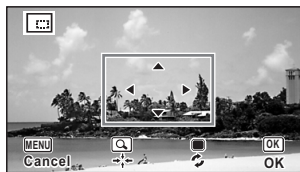









- 5** Press the OK button.

The cropped image is saved with a new file name.





The number of recorded pixels is selected automatically according to the size of the cropped image. The image is saved at the same quality level as the original.

Processing Images to Make Faces Look Smaller

Images are processed to reduce the size of people's faces detected with the Face Detection function (p.89) when taking pictures so that they look smaller.



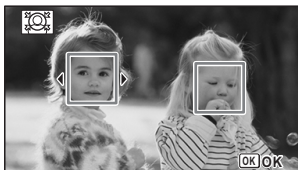

- 1** Enter  mode and use the four-way controller ( ) to choose the image you want to edit.
- 2** Use the four-way controller (   ) to select  (Small Face Filter) from the Playback Mode Palette.

- 3** Press the OK button.
The face detection frames are displayed on the faces that can be processed. Proceed to step 6 when there is only one detection frame.

- 4** Use the four-way controller (   ) to select a face to be processed.
A green frame indicates the face that is to be processed.





- 5** Press the OK button.

- 6** Use the four-way controller ( ) to change the reduction ratio.
 Approx. 5%
 Approx. 7%
 Approx. 10%



- 7** Press the OK button.
A confirmation dialog for overwriting the image appears. If the selected image is protected, the processed image is saved as a new image and the confirmation dialog does not appear.

- 8** Use the four-way controller ( ) to select [Overwrite] or [Save as].

- 9** Press the OK button.
The camera returns to  mode and the processed image is displayed.



You may not be able to process images in the following situations:

- When the size of face taken is too large or too small, in relation to the image
- When faces are located in the edges of the image

In such cases, the face detection frame in step 3 will not appear.

Using the Digital Filters

This mode lets you change the color tones and perform special processing on a selected image.

B&W/Sepia	Changes color images to black and white or processes using the sepia filter.
Toy Camera	Images seem to have been taken with a toy camera.
Retro	Images have the feel of old photos with a white border. You can choose from three filters: Original image, amber, and blue.
Color	Processes the image using the selected color filter. You can choose from six filters: red, pink, purple, blue, green, and yellow.
Extract Color	Processes the image using the selected color extraction filter. You can choose from three filters: red, green, and blue.
Color Emphasis	There are 4 filters: Sky Blue/Fresh Green/Delicate Pink/Autumn Leaves.
High Contrast	Adjusts the contrast of the captured images.
Starburst	Processes the image with a special sparkling look achieved by adding cross-like effects to a highlighted area, such as town lights at night, light reflected from water, or other light sources. You can choose from three filters: Cross, Heart, and Star.
Soft	Processes the image into a soft image that appears soft overall.
Fish-eye	Applies a fish-eye lens effect to images.
Brightness	Adjusts the brightness of the image.
Miniature	Blurs a part of the image to create a fake miniature scene.



Movies or images taken with another camera cannot be edited using the Digital Filter function. An error message appears if you choose this function from the Playback Mode Palette and press the **OK** button.

1 Enter mode and use the four-way controller (◀▶) to choose the image you want to edit.

2 Use the four-way controller (▲▼◀▶) to select (Digital Filter) from the Playback Mode Palette.

3**Press the OK button.**

The digital filter selection screen appears.

- 1 B&W/Sepia
- 2 Toy Camera
- 3 Retro
- 4 Color
- 5 Extract Color
- 6 Color Emphasis
- 7 High Contrast
- 8 Starburst
- 9 Soft
- 10 Fish-eye
- 11 Brightness
- 12 Miniature

**4****Use the four-way controller (▲▼) to choose the digital filter you want to use.**

The preview image of the result of the filter effect appears.

5**Use the four-way controller (◀▶) to adjust the effect as necessary.**

	Four-way controller (◀)	Default Setting	Four-way controller (▶)
Retro	Blue	Original image	Amber
Toy Camera	Weak	Standard	Strong
High Contrast	Weak	Standard	Strong
Fish-eye	Weak	Standard	Strong
Brightness	Dark	Standard	Bright
Miniature	Upper	Upper and lower	Lower

B&W/Sepia	B&W ↔ Sepia
Color	Red ↔ Pink ↔ Purple ↔ Blue ↔ Green ↔ Yellow
Extract Color	Red ↔ Green ↔ Blue
Color Emphasis	Sky Blue ↔ Fresh Green ↔ Delicate Pink ↔ Autumn Leaves
Starburst	Cross ↔ Heart ↔ Star

6**Press the OK button.**

A confirmation dialog for overwriting the image appears.

If the selected image is protected, the processed image is saved as a new image and the confirmation dialog does not appear.

7 Use the four-way controller (▲▼) to select [Overwrite] or [Save as].

8 Press the OK button.
The image processed with the filter is saved.

Using the HDR Filter

Adjusts parts of the image that are too bright or too dark and processes images to simulate an HDR effect.

1 Enter  mode and use the four-way controller (◀▶) to choose the image you want to edit.

2 Use the four-way controller (▲▼◀▶) to select HDR (HDR Filter) from the Playback Mode Palette.

3 Press the OK button.
The preview image of the results of the filter effect appears.

4 Press the OK button.
A confirmation dialog for overwriting the image appears.
If the selected image is protected, the processed image is saved as a new image and the confirmation dialog does not appear.

5 Use the four-way controller (▲▼) to select [Overwrite] or [Save as].

6 Press the OK button.
The image processed with the filter is saved.

Using the Ink Rubbing Filter

You can edit the image to look like an ink rubbing.



The Ink Rubbing Filter cannot be used on the following images.

- Movies or images taken in  (Report) mode
- Images taken with the recorded pixels of 12M 161, 3M, 2M 160, 1024, or 640
- Images taken with other cameras

An error message appears in step 3.

1 Enter  mode and use the four-way controller (◀▶) to choose the image you want to edit.



2 Use the four-way controller (▲▼◀▶) to select  (Ink Rubbing Filter) from the Playback Mode Palette.

3 Press the OK button.

The preview image of the result of the filter effect appears.

4 Use the four-way controller (◀▶) to choose the effect.

You can adjust the effect in five levels.

- | | |
|---|----------|
|  | Weak |
|  | Standard |
|  | Strong |

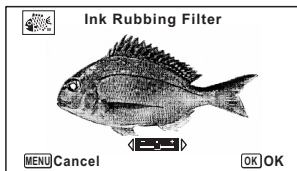

5 Press the OK button.

A confirmation dialog for overwriting the image appears.

If the selected image is protected, the processed image is saved as a new image and the confirmation dialog does not appear.

6 Use the four-way controller (▲▼) to select [Overwrite] or [Save as].

7 Press the OK button.

The image processed with the filter is saved.



- The processed image is saved with the recorded pixels of $5M / 4M$.
- When there is little contrast between the object and the background, the shape of the object may not be sharp depending on the conditions of the original image.

Creating a Collage Image

Make a collage image by placing captured images on a selected pattern.



The Collage function cannot be used on the following images.

- Movies or images taken in  (Report) mode
- Images taken with the recorded pixels of $12M$, 1024 , or 640
- Images taken with other cameras

1 Use the four-way controller (▲▼◀▶) to select  (Collage) from the Playback Mode Palette.

- 2** Press the **OK** button.
The item selection screen appears.

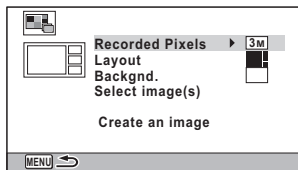

Selecting the Number of Recorded Pixels

- 3** Use the four-way controller (**▲▼**) to choose the [Recorded Pixels].

- 4** Press the four-way controller (**▶**).
A pull-down menu appears.

- 5** Use the four-way controller (**▲▼**) to choose the recorded pixels.
You can choose from **3M** or **2M**.

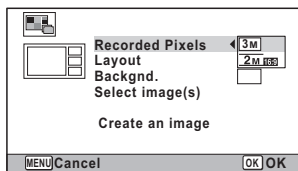

- 6** Press the **OK** button.
Returns to the item selection screen.

Selecting the Layout Pattern

- 7** Use the four-way controller (**▲▼**) to choose the [Layout].

- 8** Press the four-way controller (**▶**).
A pull-down menu appears.

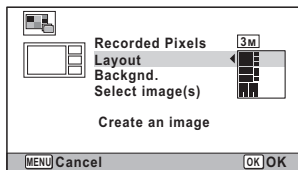

- 9** Use the four-way controller (**▲▼**) to choose the pattern of layout.
You can choose from 3 patterns of layout (■/■/■).

- 10** Press the **OK** button.
Returns to the item selection screen.

Selecting the Background

11 Use the four-way controller (▲▼) to choose [Backgnd.].

12 Press the four-way controller (▶).

A pull-down menu appears.

13 Use the four-way controller (▲▼) to choose the background.

You can choose the white background or the black background.

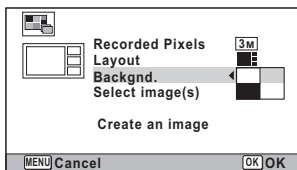

14 Press the OK button.

Returns to the item selection screen.

5

Laying Out the Images



- The following images cannot be used in a collage image, and they do not appear as available images.
 - Movies or images taken in (Report) mode
 - Images taken with the recorded pixels of 12M , 1024, or 640
 - Images taken with other cameras
- If you select an image with a 16:9 aspect ratio, the black areas appear above and below the image.

15 Use the four-way controller (▲▼) to choose [Select image(s)].

16 Press the four-way controller (▶).

The available images appear.

17 Use the four-way controller (◀▶) to choose the image to be placed and press the OK button.

The selected image is placed in the highlighted area in the guide. The guide appears on the top left of the display.

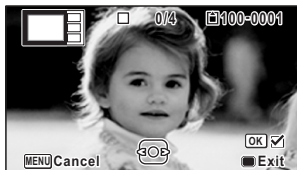

18 Repeat step 17 to lay out the rest images.

- 19** Press the **●** button.
Returns to the item selection screen.

Saving the Edited Image

- 20** Use the four-way controller (**▲▼**) to select **[Create an image]**.

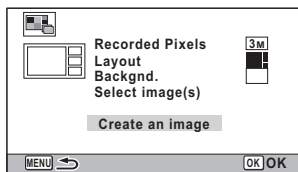

- 21** Press the **OK** button.
A confirmation dialog for saving the image appears.

- 22** Use the four-way controller (**▲**) to select **[Save]**.

- 23** Press the **OK** button.
The edited image is saved.



The quality level of the image is fixed at ★★★ (Best).

Red-eye Edit

You can correct images where the flash has caused the subject to appear with red eyes.



- The Red-eye Edit function cannot be used on movies or on images where red eyes cannot be detected on the camera. An error message appears in step 3.
- The Red-eye Edit function can only be used with still pictures taken with this camera.

- 1** Enter **▶** mode and use the four-way controller (**◀▶**) to choose the image you want to edit.

- 2** Use the four-way controller (**▲▼◀▶**) to select **👁** (Red-eye Edit) from the Playback Mode Palette.

- 3** Press the **OK** button.

A confirmation dialog for overwriting the image appears.
If the selected image is protected, the processed image is saved as a new image and the confirmation dialog does not appear.

4 Use the four-way controller (▲▼) to select [Overwrite] or [Save as].

5 Press the OK button.
The edited image is saved.

Overlaying Your Original Frame on Still Pictures

You can overlay your original frame (decorative frame) on still pictures. You can select the type and color of an original frame and its position. Text can also be entered.

Frame



Type of original frame	Blur/Edge Composite
Frame Type	<input type="checkbox"/> (All sides)/ <input type="checkbox"/> (Upper and lower sides)/ <input type="checkbox"/> (Right and left sides)/ <input type="checkbox"/> (Upper side)/ <input type="checkbox"/> (Lower side)/ <input type="checkbox"/> (Left side)/ <input type="checkbox"/> (Right side)
Color	White/Gray/Black/Pink/Pumpkin/Dark red/Dark green

Text Stamp

Available characters	A – Z, a – z, 0 – 9, Symbols, Space
Display Position	<input type="checkbox"/> (Upper-left)/ <input type="checkbox"/> (Upper-center)/ <input type="checkbox"/> (Upper-right)/ <input type="checkbox"/> (Lower-left)/ <input type="checkbox"/> (Lower-center)/ <input type="checkbox"/> (Lower-right)
Color	White/Gray/Black/Pink/Pumpkin/Dark red/Dark green



The Original Frame function cannot be used on images taken in (Report) mode, images taken with the recorded pixels of 12M / 3M / 2M / 1024 / 640 or movies. An error message appears in step 3.

- 1 Enter  mode and use the four-way controller (◀▶) to choose the image to which you want to add a frame.
- 2 Use the four-way controller (▲▼◀▶) to select  (Original Frame) from the Playback Mode Palette.
- 3 Press the OK button.
The original frame type selecting screen appears.
- 4 Use the four-way controller (▲▼) to select an original frame type, and press the OK button.
The frame setting screen appears.

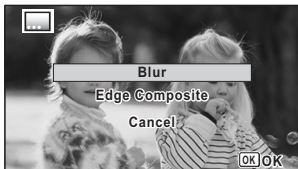

- 5 Use the four-way controller (▲▼) to select [Frame Type], and press the four-way controller (▶).



- 6 Use the four-way controller (▲▼) to select a frame type, and press the four-way controller (◀).
- 7 Set [Color] in the same way as in steps 5 and 6.
- 8 Adjust the position of the frame and image.
For details, refer to "To Adjust the Position of the Frame and Image" (p.140).
- 9 Use the four-way controller (▲▼) to select [Text Stamp], and press the four-way controller (▶).
The [Text Stamp] screen appears.
When you do not want to enter characters, proceed to step 11.

- 10 Set up the text stamp.
For details, refer to "To Set Up Text Stamp" (p.141).

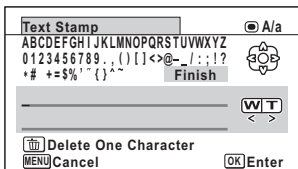

11 Press the OK button.

A confirmation dialog for overwriting the image appears.

If the selected image is protected, the processed image is saved as a new image and the confirmation dialog does not appear.

12 Use the four-way controller (▲▼) to select [Overwrite] or [Save as].**13 Press the OK button.**

The edited image is saved with the recorded pixels of **5M / 4M 16:9**.

To Adjust the Position of the Frame and Image**1 Press the Green button.**

The frame position adjustment screen appears.

Four-way controller (▲▼◀▶)	Press to adjust the position of the frame
Zoom button right (Q)	Press to make the frame larger
Zoom button left (⊞)	Press to make the frame smaller

**2 Press the Green button.**

The image position adjustment screen appears.

Four-way controller (▲▼◀▶)	Press to adjust the position of the image
Zoom button right (Q)	Press to make the image larger
Zoom button left (⊞)	Press to make the image smaller

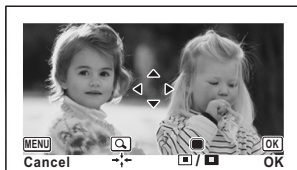
**3 Press the OK button.**

The screen returns to the original screen.

To Set Up Text Stamp

- 1 Use the four-way controller (▲▼◀▶) to select a character and press the OK button.**

The selected character is input.
Up to 52 characters can be input.

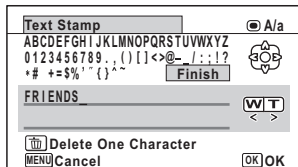

Movie button	Press to switch between upper and lower cases
Zoom button right (Q)	Press to move the cursor to the right
Zoom button left (W)	Press to move the cursor to the left
Trash button	Press to delete a character

- 2 Use the four-way controller (▲▼◀▶) to select [Finish] and press the OK button.**

- 3 Use the four-way controller (▲▼) to select [Display Position] and press the four-way controller (▶).**



- 4 Use the four-way controller (▲▼) to select the display position and press the four-way controller (◀).**
- 5 Use the four-way controller (▲▼) to select [Color] and press the four-way controller (▶).**
- 6 Use the four-way controller (▲▼) to select the color and press the four-way controller (◀).**

To View the Preview Screen

- 1 Press the Green button.**
The preview screen appears.





- 2 Press the MENU button.**
The screen returns to the original screen.
- 3 Press the OK button.**
Proceed to step 11 on p.140.

Editing Movies

5

You can extract a frame from a movie to save as a still picture, divide a movie into two, or add a title picture to a movie.

- 1 Enter  mode and use the four-way controller (◀▶) to choose the movie you want to edit.**
- 2 Use the four-way controller (▲▼◀▶) to select  (Movie Edit) from the Playback Mode Palette.**
- 3 Press the OK button.**
The edit option selection screen appears.

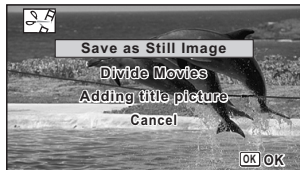

To Save a Frame from a Movie as a Still Picture

- 4 Select [Save as Still Image] on the edit option selection screen.**
- 5 Press the OK button.**
The screen for selecting a frame to be saved as a still picture appears.

6 Use the four-way controller (▲▼◀▶) to choose the frame you want to save.

- ▲ Plays back or pauses the movie
- ▼ Stops the movie and returns to the first frame
- ◀ Reverses the movie frame by frame
- ▶ Advances the movie frame by frame



7 Press the OK button.

The selected frame is saved as a still picture.

To Divide a Movie

4 Select [Divide Movies] on the edit option selection screen.

5 Press the OK button.

The screen for choosing a dividing position appears.

6 Use the four-way controller (▲▼◀▶) to specify the dividing position.

- ▲ Plays back or pauses the movie
- ▼ Stops the movie and returns to the first frame
- ◀ Reverses the movie frame by frame
- ▶ Advances the movie frame by frame



7 Press the OK button.

A confirmation dialog appears.

8 Use the four-way controller (▲) to select [Divide].

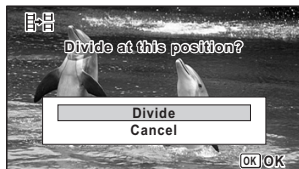

9 Press the OK button.

The movie is divided at the specified position, each segment is saved as a new file, and the original movie is deleted.



The protected movies cannot be divided.



- Only a movie for more than 2 seconds (31 frames) can be divided.
- For dividing, every 30 frames (31st, 61st, 91st.. frames) can be selected.

To Add a Title Picture to a Movie

4 Select [Adding title picture] on the edit option selection screen.

5 Press the OK button.

The screen for selecting a title picture appears.



6 Use the four-way controller (◀▶) to choose the desired title picture.

Only images available for the title picture are displayed.

7 Press the OK button.

The screen for confirming the position of the title picture appears.

8 Use the four-way controller (▲▼) to select the position.

-  Adds the title picture to the beginning of the movie
-  Adds the title picture to the end of the movie

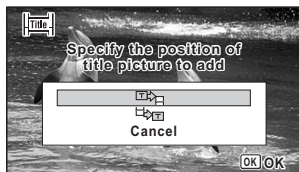

9 Press the OK button.

The selected picture is saved as the title picture.



- A title picture cannot be added to protected movies.
- If a movie is more than 26 minutes long after adding title pictures, you cannot add any more title pictures to it.



- When a title picture is added to the beginning of a movie: When the movie is played back, the added still picture is played back for three seconds, and then the movie is played back. The added still picture is used as the thumbnail of the movie.
When a title picture is added to the end of a movie: When the movie is played back, the movie is played back, and then the added still picture is played back for three seconds. The thumbnail of the movie is not changed by adding a title picture to the end of the movie.
- Only a still picture with the same aspect ratio as the movie can be set as a title picture.

Copying Images

You can copy images from the built-in memory to the SD Memory Card and vice versa. This function can only be selected when an SD Memory Card is inserted in the camera.



Make sure that the camera is turned off before inserting or removing the SD Memory Card.



1 Use the four-way controller (▲▼◀▶) to select  (Image Copy) from the Playback Mode Palette.

2 Press the OK button.

The copying method selection screen appears.

To Copy Files from the Built-in Memory to the SD Memory Card

All the images in the built-in memory are copied to the SD Memory Card at once. Before copying the images, make sure that there is enough space on the SD Memory Card.

3 Use the four-way controller (▲) to select [ → ].



4 Press the OK button.

All the images are copied to the SD Memory Card.

To Copy Files from the SD Memory Card to the Built-in Memory

The image selected from the SD Memory Card is copied to the built-in memory.

3 Use the four-way controller (▲▼) to select [SD ➔ ●].

4 Press the OK button.

5 Use the four-way controller (◀▶) to select the image you want to copy.



6 Press the OK button.

The selected image is copied to the built-in memory.

To copy other images, repeat steps 3 to 6. Select [Cancel] to exit the copy operation.

5



When an image is copied from the SD Memory Card to the built-in memory, a new file name is assigned to the copied image.

Camera Settings

Using the Setting Menu Items

Settings for the camera are set from the [Setting] menu. Refer to explanations for each function on how to make these settings.

- 1 Press the MENU button in [mode] mode.**

The [Setting] menu appears.
When you press the MENU button in [mode] mode, press the four-way controller (D) once or twice.
- 2 Use the four-way controller (▲▼◀▶) to select an item and set it up.**
- 3 After finishing the settings, press the MENU button.**

The setting is saved and the camera returns to the previous screen.

To Save the Setting and Start Taking Pictures

- 3 Press the shutter release button halfway.**

The setting is saved and the camera returns to capture mode.



When the [Setting] menu is displayed from [mode] mode, you can switch to [mode] mode by pressing the [mode] button.

To Cancel the Changes and Continue with Menu Operations

- 3 Press the MENU button before you finish the settings.**

The changes are canceled and you can select a menu.



The MENU button function varies depending on the screen. Refer to the guide indications.

	Exit	Exits the menu and returns to the original screen.
		Returns to the previous screen with the current settings.
	Cancel	Cancels the current selection, exits the menu and returns to the previous screen.

Formatting the Memory

Formatting deletes all the data on the SD Memory Card or in the built-in memory. Be sure to use this camera to format (initialize) an SD Memory Card that is unused or has been previously used on other cameras or digital devices.

Caution

- Do not remove the SD Memory Card while it is being formatted. This may damage the card and make it unusable.
- Formatting deletes protected images and any data recorded on the card with a computer or any camera.
- SD Memory Cards formatted on a computer or device other than this camera cannot be used. Be sure to format the card with the camera.
- To format the built-in memory, be sure to eject the SD Memory Card beforehand. Otherwise, the SD Memory Card will be formatted.

1 Use the four-way controller (▲▼) to select [Format] in the [↶ Setting] menu.

2 Press the four-way controller (▶).
The [Format] screen appears.

3 Use the four-way controller (▲) to select [Format].

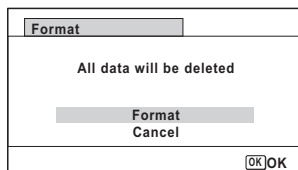

4 Press the OK button.
Formatting starts.

When formatting is completed, the camera returns to mode or mode.

Changing the Sound Settings

You can adjust the volume of operation sounds and change the type of sound.

1 Use the four-way controller (▲▼) to select [Sound] in the [↖ Setting] menu.

2 Press the four-way controller (▶).

The [Sound] screen appears.

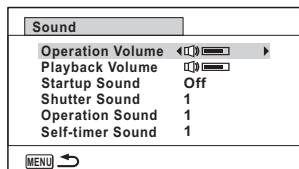

To Change the Operation Volume/Playback Volume

3 Use the four-way controller (▲▼) to select [Operation Volume].

4 Use the four-way controller (◀▶) to adjust the volume.

Set the volume to to mute the start-up sound, shutter sound, operation sound, and self-timer sound.

5 Change [Playback Volume] in the same way as in steps 3 and 4.

To Change the Sound Type

3 Use the four-way controller (▲▼) to select [Startup Sound].

4 Press the four-way controller (▶).

A pull-down menu appears.

5 Use the four-way controller (▲▼) to select the sound type.

Choose from [1], [2], [3], [4], or [Off].

6 Press the OK button.

7 Set [Shutter Sound], [Operation Sound] and [Self-timer Sound] in the same way as in steps 3 to 6.

Changing the Date and Time

You can change the initial date and time settings (p.41), and the style in which the date appears on the display.

1 Use the four-way controller (▲▼) to select [Date Adjustment] in the [↵ Setting] menu.

2 Press the four-way controller (▶).

The [Date Adjustment] screen appears.

Date Adjustment	
Date Format	▶ mm/dd/yy 24h
Date	01/01/2022
Time	00:00
Settings complete	
[MENU] Cancel	

3 Press the four-way controller (▶).

The frame moves to [mm/dd/yy].

Depending on the initial setting or previous setting, [dd/mm/yy] or [yy/mm/dd] may be displayed.

4 Use the four-way controller (▲▼) to choose the date and time display style.

Choose from [mm/dd/yy], [dd/mm/yy] or [yy/mm/dd].

5 Press the four-way controller (▶).

The frame moves to [24h].

6 Use the four-way controller (▲▼) to select [24h] (24-hour display) or [12h] (12-hour display).

7 Press the four-way controller (▶).

The frame returns to [Date Format].

8 Press the four-way controller (▼).

The frame moves to [Date].

9 Press the four-way controller (▶).

The frame moves to one of the following items depending on the date style set in step 4.

Month for [mm/dd/yy]

Day for [dd/mm/yy]

Year for [yy/mm/dd]

The following operations use [mm/dd/yy] as an example. The operations are the same even if another date style has been selected.

10 Use the four-way controller (▲▼) to change the month.

11 Press the four-way controller (▶).

The frame moves to the day field. Use the four-way controller (▲▼) to change the day. After changing the day, change the year in the same manner.

12 Change the time in the same way as in steps 7 to 11.

If you selected [12h] in step 6, the camera switches between am and pm corresponding to the time.

13 Press the four-way controller (▼) to select [Settings complete].

14 Press the OK button.

The date and time settings are saved and the screen returns to the [↶ Setting] menu.



When you press the **OK** button in step 14, the camera clock is reset to 0 seconds. To set the exact time, press the **OK** button when the time signal (on the TV, radio, etc.) reaches 0 seconds.

Setting the Alarm

You can set the alarm to ring at a specified time.

You can choose whether the alarm will ring at the same time every day or only once at the set time.

Setting the Alarm

1 Use the four-way controller (▲▼) to select [Alarm] in the [↶ Setting] menu.

2 Press the four-way controller (▶).

The [Alarm] screen appears.

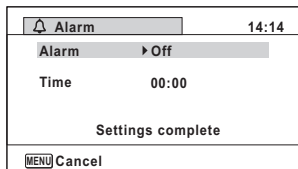

3 Press the four-way controller (▶).

A pull-down menu appears.

4 Use the four-way controller (▲▼) to select the alarm.

Choose from [Off], [Once], or [Everyday].

5 Press the OK button.**6 Press the four-way controller (▼).**

The frame moves to the [Time] field.

7 Press the four-way controller (▶).

The frame moves to the hour field.

8 Use the four-way controller (▲▼) to change the hours, then press (▶).

The frame moves to the minute field.

Change the minutes in the same manner.

9 Press the OK button.**10 Press the four-way controller (▼).**

The frame moves to [Settings complete].

11 Press the OK button.

When the alarm is set to [Off], the settings are saved and the screen returns to the [↶ Setting] menu.

When the alarm is set to [Once] or [Everyday], [Alarm is set] is displayed and the power turns off.

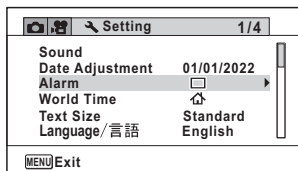
**Checking the Alarm****1 Use the four-way controller (▲▼) to select [Alarm] in the [↶ Setting] menu.**

Check that [Alarm] is set to (On).

2 Press the four-way controller (▶).

The [Alarm] screen appears.

Check the alarm frequency and time.

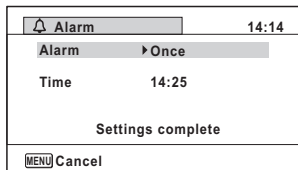

Turning the Alarm Off



The Clock Display appears and the alarm rings for one minute when the set time is reached while the camera is turned off.

You can stop the alarm by pressing any button on the camera while the alarm is ringing.







- The alarm will not ring if the camera is on when the set time is reached.
- Even if an alarm is set, it will not ring when Interval Shot or Interval Movie is set.

Setting the World Time

The date and time selected in “Setting the Date and Time” (p.41) and “Changing the Date and Time” (p.150) serve as the  (Hometown) date and time. By using the world time function, you can display the time in the city that you select as  (Destination). This is useful when taking pictures in a different time zone.



To Set the Destination

1 Use the four-way controller ( ) to select [World Time] in the [ Setting] menu.

2 Press the four-way controller () .

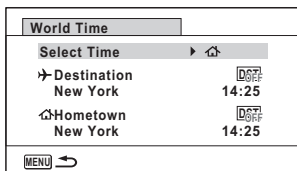
The [World Time] screen appears.



3 Use the four-way controller ( ) to select  (Destination).

4 Press the four-way controller () .

The [Destination] screen appears. The city that is currently selected blinks on the map.

5 Use the four-way controller (◀▶) to change the Destination city.

The current time, location and time difference of the selected city appear.

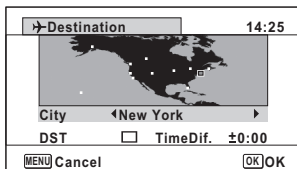

6 Use the four-way controller (▲▼) to select [DST].

7 Use the four-way controller (◀▶) to select (On) or (Off).

Select if the Destination city uses daylight saving time.

8 Press the OK button.

The [World Time] setting is saved.



Select  (Hometown) in step 3 to set the city and DST setting for the Hometown city.

To Display the Time of the Destination (Select Time)

1 Use the four-way controller (▲▼) to select [World Time] in the [Setting] menu.

2 Press the four-way controller (▶).

The [World Time] screen appears.

3 Use the four-way controller (▲▼) to select [Select Time].

4 Press the four-way controller (▶).

A pull-down menu appears.



5 Use the four-way controller (▲▼) to select (Destination) or (Hometown).

 Displays the time of the Destination city

 Displays the time of the Hometown city

6 Press the OK button.

The setting is saved.

When  (Destination) is selected the  icon appears on the display to indicate that the date and time of the Destination city are displayed in  mode.



Setting the Text Size on the Menu

You can set the text size of the item with the selection frame on the menu to [Standard] (normal display) or [Large] (magnified display).

1 Use the four-way controller (▲▼) to select [Text Size] in the [↖ Setting] menu.

2 Press the four-way controller (▶).

A pull-down menu appears.

3 Use the four-way controller (▲▼) to select the text size.

Select from [Standard] or [Large].

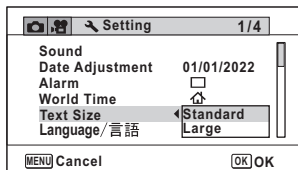

4 Press the OK button.

The setting is saved.

Changing the Display Language

You can change the language in which the menus, error messages, etc. are displayed.

1 Use the four-way controller (▲▼) to select [Language/言語] in the [↖ Setting] menu.

2 Press the four-way controller (▶).

The [Language/言語] screen appears.

3 Use the four-way controller (▲▼◀▶) to select the desired language.

4 Press the OK button.

The menus and messages are displayed in the selected language.

Changing the Naming System of the Folder

You can change the naming system of the folder for storing images. When the naming system is set to the [Date], images are saved in separate folders by the date they were taken.

Choice	The name of the folder
Date (Default)	xxx_mmdd (3-digit folder number_month day) * xxx_ddmm (3-digit folder number_day month) when the date format is set to [dd/mm/yy] A folder is made by day, and the images of the day are saved in the folder.
RICOH	xxxRICOH (xxx is the 3-digit folder number) Up to 9999 images are saved in the same folder.
_USER	xxxxxAAAA (xxx is the automatically given 3-digit folder number, and AAAAA is the 5-digit characters that you entered) Up to 9999 images are saved in the same folder.

Image taken on December 1 with the folder name setting set to [Date] created.

A folder with the name "100_1201" is created.

The images are saved in the "100_1201" folder.

Image taken on December 8 with the folder name setting set to [Date] created.

A folder with the name "101_1208" is created.

The images are saved in the "101_1208" folder.

Image taken on December 10 with the folder name setting set to [RICOH] created.

A folder with the name "102RICOH" is created.

The images are saved in the "102RICOH" folder.

Image taken on December 15 with the folder name setting set to [RICOH] created.

A new folder is not created.

The images are saved in the "102RICOH" folder.

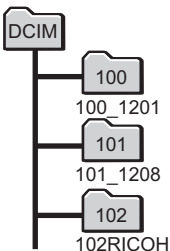
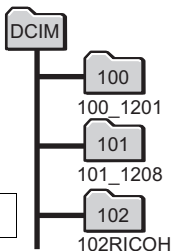
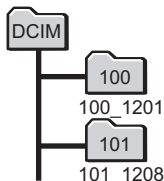
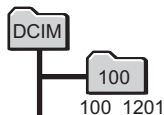

- Up to 900 folders can be created.
- Up to 9999 images can be saved in a folder.

Selecting a Rule for Naming Folders

- 1** Use the four-way controller (▲▼) to select [Folder Name] in the [↖ Setting] menu.
- 2** Press the four-way controller (▶).
A pull-down menu appears.
- 3** Use the four-way controller (▲▼) to select the rule for naming folders.
- 4** Press the OK button.
The setting is saved.

Naming the Folder Yourself

You can name the folder in which to save images.
You can enter up to five single-byte alphanumeric characters.
The 5-digit name is displayed after the 3-digit folder number.

- 1** Select [USER] in step 3 in “Selecting the Rule for Naming Folders”.
- 2** Press the four-way controller (▶).
The [Folder Name] screen appears.
“_USER” has already been entered.
- 3** Use the four-way controller (▲▼◀▶) to select a character to enter, and press the OK button.
The first character is fixed and the cursor moves to the second character.
- 4** Repeat step 3 and enter the remaining characters.

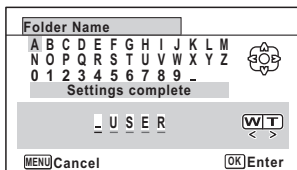

- 5** Press the four-way controller (◀) while “A” is selected, or press (▼▶) while “_” is selected.

The frame moves to [Settings complete].

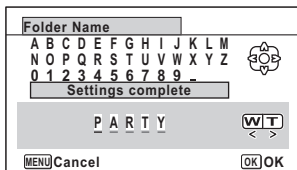

- 6** Press the OK button twice.

The folder name is fixed, and returns to the [↖ Setting] menu.



- You can move the cursor by pressing the zoom button.
- The folder name you have set is displayed in the [↖ Setting] menu.

Changing the Naming System of the File

You can change the naming system of the file.

Choice	The name of the file
RIMG (Default)	RIMGxxxx (xxxx is the automatically assigned 4-digit file number) The file number follows the setting character which is specified to the camera.
USER	AAAAxxxx (xxxx is the automatically assigned 4-digit file number) The file number follows the name you have entered.

Selecting a Rule for Naming Files

- 1** Use the four-way controller (▲▼) to select [File Name] in the [↖ Setting] menu.
- 2** Press the four-way controller (▶).
A pull-down menu appears.
- 3** Use the four-way controller (▲▼) to select the rule for naming files.
- 4** Press the OK button.
The setting is saved.

Naming the File Yourself

You can name the file of images that are captured.

You can enter up to four single-byte alphanumeric characters. The 4-digit name is displayed before the 4-digit file number.

1 Select [USER] in step 3 in “Selecting a Rule for Naming Files”.

2 Press the four-way controller (▶).

The [File Name] screen appears.

“USER” has already been entered.

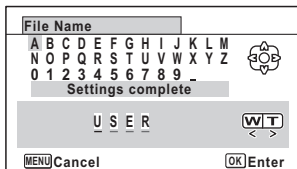

3 Use the four-way controller (▲▼◀▶) to select a character to enter, and press the OK button.

The first character is fixed and the cursor moves to the second character.

4 Repeat step 3 and enter the remaining characters.

5 Press the four-way controller (◀) while “A” is selected, or press (▼▶) while “_” is selected.

The frame moves to [Settings complete].

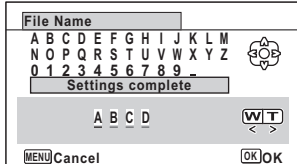

6 Press the OK button twice.

The file name is fixed, and returns to the [↖ Setting] menu.



- You can move the cursor by pressing the zoom button.
- The file name you have set is not changed even if you reset the camera.

Selecting the HDMI Output Format

When you connect the camera to an AV device with an HDMI cable, select an output resolution for playing back images. The default setting is [Auto].

- 1 Use the four-way controller (▲▼) to select [HDMI Out] in the [↖ Setting] menu.**
- 2 Press the four-way controller (▶).**
A pull-down menu appears.
- 3 Use the four-way controller (▲▼) to select an output format.**
Select an HDMI output format to match the output format of an AV device.
- 4 Press the OK button.**
The setting is saved.

Adjusting the Brightness of the Display

You can adjust the brightness of the display to 7 levels.

- 1 Use the four-way controller (▲▼) to select [Brightness Level] in the [↖ Setting] menu.**
- 2 Use the four-way controller (◀▶) to adjust the brightness.**

 - Dark
 - Normal
 - Bright



When [Outdoor View Stg.] is set to the brightness other than  (Off), [Brightness Level] is disabled.

Adjusting the Brightness of the Display for Outdoor Shooting

If the monitor display is difficult to see when you take pictures outdoors or in other situations, adjust the brightness of the display in [Outdoor View Stg.].

- 1 Use the four-way controller (▲▼) to select [Outdoor View Stg.] in the [↖ Setting] menu.**
- 2 Press the four-way controller (▶).**

A pull-down menu appears.

3 Use the four-way controller (▲▼) to adjust the brightness.

Choose from , , ,  or .

4 Press the OK button.

The setting is saved.

Using the Power Saving Function

You can save the battery power by setting the display to dim automatically when no operation is performed for a fixed time. After the Power Saving function has been activated, the display returns to the ordinary brightness if any button is pressed.

1 Use the four-way controller (▲▼) to select [Power Saving] in the [Setting] menu.

2 Press the four-way controller (▶).

A pull-down menu appears.





3 Use the four-way controller (▲▼) to select the time until the camera enters Power Saving mode.

Choose from [2min.], [1min.], [30sec.], [15sec.], [5sec.] or [Off].

4 Press the OK button.

The setting is saved.



- Power Saving does not function in the following situations:
 - While taking pictures in  (Continuous Shooting) and  (Burst Shooting) modes
 - In playback mode
 - During movie recording
 - While the camera is connected to a computer
 - While a menu is being displayed
 - In  (Digital Microscope) mode
 - When [Outdoor View Stg.] is set to the brightness other than  (Off).
- When no operation is performed after the camera is turned on, Power Saving is activated only after 15 seconds elapse even if [5sec.] is set.

Using the Auto Power Off Function

You can set the camera to turn off automatically when no operation is performed for a fixed time.

- 1 Use the four-way controller (▲▼) to select [Auto Power Off] in the [Setting] menu.**
- 2 Press the four-way controller (▶).**
A pull-down menu appears.
- 3 Use the four-way controller (▲▼) to select the time until the camera turns off automatically.**
Choose from [5min.], [3min.] or [Off].
- 4 Press the OK button.**
The setting is saved.



Auto Power Off does not function in the following situations:

- While taking pictures in (Continuous Shooting) and (Burst Shooting) modes
- While recording a movie
- During a slideshow or movie playback
- While the camera is connected to a computer

6

Settings

Setting the Quick Zoom Function

While playing back images in mode, you can set whether to use [Quick Zoom] to magnify the playback image up to 10x when pressing the button once.

- 1 Use the four-way controller (▲▼) to select [Quick Zoom] in the [Setting] menu.**
- 2 Use the four-way controller (◀▶) to switch between (On) or (Off).**
 - (On) The Quick Zoom is available.
 - (Off) The Quick Zoom is not available.

Setting the Guide Display

Set whether to display mode guides for the Capture Mode Palette and Playback Mode Palette.

- 1 Use the four-way controller (▲▼) to select [Guide Display] in the [⌘ Setting] menu.**
- 2 Use the four-way controller (◀▶) to switch between (On) or (Off).**
 - (On) The mode guides are displayed.
 - (Off) The mode guides are not displayed.

Perform Pixel Mapping

Pixel Mapping is the function for mapping out and correcting defective pixels in the image sensor. Run the Pixel Mapping function if image dots always seem to be defective in the same place.



- Pixel Mapping is only accessible from mode. Pixel Mapping cannot be selected even if the [⌘ Setting] menu is displayed by pressing the **MENU** button in mode.
- When executing Pixel Mapping from mode, press the button once to enter mode. Then press the **MENU** button and the four-way controller (▶) to display the [⌘ Setting] menu and select Pixel Mapping.

- 1 Use the four-way controller (▲▼) to select [Pixel Mapping] in the [⌘ Setting] menu.**
- 2 Press the four-way controller (▶).**

The [Pixel Mapping] screen appears.
- 3 Use the four-way controller (▲) to select [Pixel Mapping].**

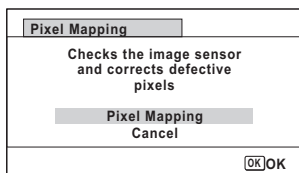

- 4 Press the OK button.**

Defective pixels are mapped out and corrected.

When the battery level is low, [Not enough battery power remaining to activate Pixel Mapping] appears on the display. Use a battery with ample capacity remaining.

Changing the Start-up Screen

You can choose the start-up screen displayed when the camera is turned on.

You can choose any of the following images as the start-up screen:

- Guide display start-up screen showing a guide for the shooting modes and buttons
- Pre-installed screen
- One of the captured images (compatible images only)

1 Use the four-way controller (▲▼◀▶) to select (Start-up Screen) from the Playback Mode Palette.

2 Press the OK button.

The image selection screen appears.

3 Use the four-way controller (◀▶) to choose the image for the start-up screen.

Only images available for the start-up screen are displayed. You can also choose the pre-installed screen or guide display start-up screen already stored in the camera.



4 Press the OK button.

The setting is saved.



- Once the start-up screen has been set, it will not be deleted even if the original image is deleted or the SD Memory Card or built-in memory is formatted. However the image is deleted if you change the start-up screen after deleting the recorded image or formatting the memory.
- The start-up screen is not displayed when set to [Off].
- The start-up screen is not displayed when you turn the camera on in playback mode.
- Movies cannot be used for the start-up screen.

Resetting to Default Settings (Reset)

You can reset the camera settings to their defaults. Refer to “Default Settings” (p.180) for the reset settings.

1 Use the four-way controller (▲▼) to select [Reset] in the [↶ Setting] menu.

2 Press the four-way controller (▶).

The [Reset] screen appears.

3 Use the four-way controller (▲) to select [Reset].

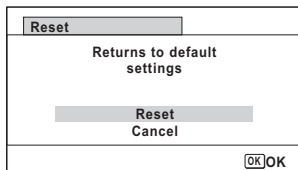

4 Press the OK button.

The settings return to the defaults.

Setting the Startup Shortcut

You can start-up a function by pressing a button other than the power button even when the camera is off.

Playback Mode	When [Playback Mode] is on, you can turn on the camera in playback mode by pressing and holding down the [▶] button.
LED Lighting	When [LED Lighting] is on, you can turn on the LED Macro Lights by pressing and holding down the Green button.
Clock Display	When [Clock Display] is on, you can display the clock on the display by pressing and holding down the OK button.

1 Use the four-way controller (▲▼) to select [Startup Shortcut] in the [↶ Setting] menu.

2 Press the four-way controller (▶).

The [Startup Shortcut] screen appears.

3 Use the four-way controller (▲▼) to select an item.

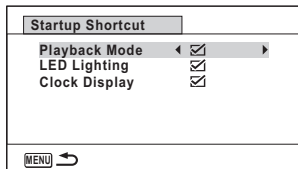

4 Use the four-way controller (◀▶) to switch between (On)/ (Off).

- (On) The startup shortcut is available.
- (Off) The startup shortcut is not available.



The default settings are all (On).

Displaying the Clock Display

You can use the camera as a clock. With the camera turned off, press and hold down the **OK** button to display the clock on the display.

1 Press and hold down the **OK** button.

The camera turns on and the clock appears on the screen.

The camera turns off automatically after approximately 10 seconds.

Pressing the power button turns the camera off immediately.



Not to function the Clock Display by pressing **OK** button, set [Clock Display] to (Off) in [Startup Shortcut] from the [Setting] menu. (p.165)

Light up the LED Macro Lights

You can use the camera as a light. Pressing and holding down the Green button lights up the LED Macro Lights when the camera is turned off.

1

Press and hold down the Green button.

The LED Macro Lights turn on. The lights turn off automatically after the lapse of the time set in [Auto Power Off].

Pressing the power button turns the camera off immediately.



- Not to light up the LED Macro Lights by pressing and holding the Green button, set [LED Lighting] to (Off) in [Startup Shortcut] of the [Setting] menu (p.165).
- When [Auto Power Off] is set to [Off], the LED Macro Lights do not turn off automatically.
- Press the power button to turn off the LED Macro Lights.

Connecting to a Computer

Setting the USB Connection Mode

Set the device to which the camera is connected with the USB cable.



Always set the USB Connection mode before connecting the camera to a computer. You cannot perform the following setting after the camera is connected to a computer with the USB cable.

- 1 Turn your camera on.**
- 2 Use the four-way controller (▲▼) to select [USB Connection] in the [↖ Setting] menu.**
- 3 Press the four-way controller (▶).**
A pull-down menu appears.
- 4 Use the four-way controller (▲▼) to select [MSC].**
- 5 Press the OK button.**
The setting is saved.

MSC and PTP

7

MSC (Mass Storage Class)

A general-purpose driver program that handles devices connected to the computer via USB as a memory device. Also indicates a standard for controlling USB devices with this driver.

By simply connecting a device that supports USB Mass Storage Class, you can copy, read, and write files from a computer without installing a dedicated driver.

PTP (Picture Transfer Protocol)

A protocol that allows transfer of digital images and control of digital cameras via USB, standardized as ISO 15740.

You can transfer image data between devices that support PTP without installing a device driver.

Unless otherwise specified, select MSC when connecting the camera to a computer.

Connecting the Camera and a Computer

Connect the camera to a computer using the provided USB cable.

- 1 Turn the computer on.**
- 2 Turn the camera off.**
- 3 Connect the camera to the computer using the USB cable.**
The power lamp blinks when the camera is connected to the computer correctly.

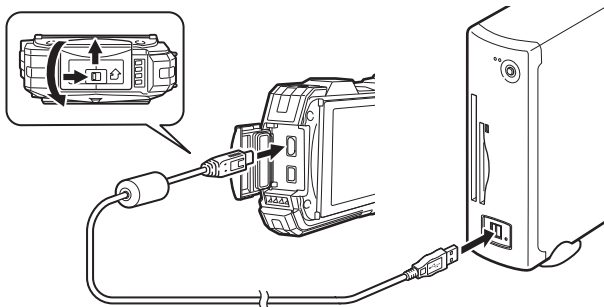

- 4 Turn your camera on.**
The power lamp stops blinking and remains lit when the camera is recognized as a removable disk by the computer.
If the "WG-80" dialog appears when the camera is turned on, select [Open folder to view files] and click the **OK** button.
- 5 Save the captured images to the computer.**



If the battery runs out of power while images are being transferred to a computer, the image data may be lost or damaged. When connecting the camera to a computer, use a battery with ample capacity remaining.



For information on system requirements, refer to p.170.

Disconnecting the Camera from the Computer

When the camera is being used by an application, it cannot be disconnected until the application is closed.

Windows

- 1 Click the  (Safely Remove Hardware) icon in the task bar located at the bottom-right corner of the desktop.
- 2 Click [Eject (the device connected)].
The message appears.

- 3 Disconnect the USB cable from the Windows PC and your camera.

Mac

- 1 Drag [NO NAME] on the desktop to the trash.
If the SD Memory Card has a volume label, drag the icon of that name to the trash.
- 2 Disconnect the USB cable from the Mac and your camera.



The camera will automatically switch to playback mode when the USB cable is disconnected from the camera or the computer.

System Requirements

The following system requirements must be met for you to fully enjoy the images captured with the camera on a computer.



- Supported OS should be pre-installed in a computer and updated to the latest version.
- The computer should meet the system requirements for the supported OS and be equipped with a USB port.
- Working status is not guaranteed for all computers.

Supported OS

Windows®	Windows® 8.1, Windows® 10, Windows® 11
Mac	macOS 10.15, macOS 11, macOS 12

Functions Available for Each Shooting Mode

√: Can be set.

×: Cannot be set.

—: Settings and changes are not applied.

Function		Shooting Mode							
		AUTO PICT	P	HDR					
Zoom button	Zoom operation	√*2	√	√	√	√	√*3	√	√*3
Flash Mode	Auto	√	√	×	×	×	×	√	×
	Flash Off	√	√	√	√	√	√	√	√
	Flash On	√	√	×	√	×	×	√	×
	Auto + Red-eye	√	√	×	×	×	×	√	×
	Flash On + Red-eye	√	√	×	√	×	×	√	×
	Flash Off + Flash On (2 shots)	×	×	×	×	×	×	√	×
Drive Mode	Macro Lights	×	√	×	×	×	√	×	×
	Standard	√	√	√	√	×	√	√*38	√
	Self-timer	√	√	√	√	×	√	√*38	√
	Continuous Shooting/ Burst Shooting	×	√	×	×	×	×	√*38	×
	Remote Control	√	√	√	√	×	√	√*38	√
Focus Mode	Auto Bracketing	×	√	×	√	×	×	√*38	×
	AF Standard	√	√	√	√	√	√	√	√
	Macro	√	√	√	√	√	√	√	√
	1cm Macro	√	√	√	√	√	√	√	√
	PF Pan Focus	√	√	√	√	√	√	√	√
	Infinity	√	√	√	√	√	√	√	√
MF Manual Focus	√	√	√	√	√	√	√	√	

(To be continued to p.174)

√	√	√	√ ^{*36}	√ ^{*36}	√ ^{*4}	√	√	√	√	√	√ ^{*5}	√ ^{*6}
√	√	√	x	x	x	√	√	√	x	√	√	√
√	√	√	√	√	√	√	√	√	√	√	√	√
√	√	√	x	x	x	√	√	√	x	√	x	x
√	√	√	x	x	x	√	√	√	x	√	x	x
√	√	√	x	x	x	√	√	√	x	√	x	x
x	x	x	x	x	x	x	x	x	x	x	x	x
x	x	x	x	x	x ^{*21}	x	x	x	x	x	√	x ^{*7}
√	√	x	x	√	√	√	√	√	√	√	√	√
√	√	x	x	√	√	√	√	√	√	√	√	√
√	√	x	x	x	x	√	√	√	x	√	x	x
√	√	√	√	√	x	√	√	√	x	√	√	√
√	√	√	√	√	√	√	√	√	x	√	x	x
√	√	√	√	√	√	√	√	√	x	√	√	√
√	√	√	√	√	x	√	√	√	√	√	√	√
√	√	√	√	√	x	√	√	√	√	√	√	x
√	√	√	x	√	x	√	√	√	x	√	√	x

√: Can be set.

×: Cannot be set.

—: Settings and changes are not applied.

Function		Shooting Mode									
		AUTO PICT	P	HDR	📷	📷	📷	📷	📷	📷	
[📷 Rec. Mode] menu	Image Tone	x*8	√	x*8	√	√	√	√	x*8	x*8	
	Recorded Pixels	√	√	√	√	√	√	√ ¹⁰	√	√ ¹⁰	
	Quality Level	√	√	√	√	√	√	x*16	√	x*16	
	White Balance	x*18	√	√	√	√	√	√	x*18	x*18	
	AF Setting	Focusing Area	x*19	√	√	√	√	√	√ ²⁰	√	√ ²⁰
		Auto Macro	√	√	√	√	√	√	√	√	√
		Focus Assist	√	√	√	√	√	√	x*7	√	x*7
	AE Metering	x*22	√	√	√	√	√	x*22	x*22	x*22	
	Sensitivity	√	√	x*23	√	√ ¹³	x*23	√	x*23	x*23	
	AUTO ISO Range	√	√	√ ¹³	√	√ ¹³	x*25	√	x*25	x*25	
	EV Compensation	x*27	√	√	√	√	√	√	√	√	
	D-Range Setting	x*7	√	x*7	√	√ ⁹	√	√	√	√	
	Pixel Track SR ¹	√	√	√ ³²	√	x*33	√	√	√	√	
	Face Detection	Face Detection On	√	√	√	√	√	√	√	√	√
		Smile Capture	√	√	√	√	√	√	√	√	√
		Self-portrait Assist / Self-portrait Assist + Smile Capture	√ ²⁹	√ ²⁹	√ ²⁹	√ ²⁹	√ ²⁹	x	√ ²⁹	x	x
		Face Detection Off	x	√	√	√	√	√	√	√	√
		Blink Detection	√	√	x*7	√	√	x*7	√	x*7	x*7
	Digital Zoom	√ ³⁵	√ ³⁵	√	√ ³⁵	√ ³⁵	√	√ ³⁵	√	√	
	Instant Review	√	√	√	√	√	—	√	—	—	
Memory	√	√	√	√	√	√	√	√	√		
Green Button	√	√	√	√	√	√	√	√	√		
Sharpness/Saturation (Tone Adjustment)/Contrast	x*28	√	√	√	√	√	x*28	x*28	x*28		
Date Imprint	√	√	√	√	√	x*12	√	x*12	x*12		
IQ Enhancer	√	√	√	√	√	x*7	√	√	√		
Macro Light	x	√	x	x	x	√	x	x	x		

*1 Movie SR is used for movies, while Pixel Track SR is used for still pictures.

*2 🌸 (Flower) cannot be detected when using digital zoom or Intelligent Zoom.

*3 Digital zoom is available. Optical zoom is available before shooting. Intelligent Zoom is not available.

*4 Only optical zoom and Intelligent Zoom are available, digital zoom is not available.

*5 Only optical zoom is available, digital zoom and Intelligent Zoom are not available.

*6 Only optical zoom and digital zoom are available, Intelligent Zoom is not available.

*7 Fixed to (Off)

*8 Fixed at [Bright]

*9 Only Shadow Correction is available.

*10 Set in [📷 Movie] menu

*11 Select from 12M(16:9)/5M(16:9)/4M(16:9)/2M(16:9).

*12 Fixed to [Off]

*13 The maximum sensitivity is 1600.

*14 Select from [3M]/[2M]/[1280]

*15 Fixed to 12M fps

x*8	x*8	√	√	√	√	√	x*8	x*8	x*8	x*8	x*8
√	√	√	x	x*31	√*11	√	√	√	√	√*14	x*15
√	√	√	x*16	x*16	√	√	√	√	√	√	x*17
x*18	x*18	√	√	√	√	√	x*18	x*18	x*18	x*18	x*18
√	√	√	√*20	√*20	√	√	√	√	x*19	√	x*19
√	√	√	√	√	x	√	√	√	x	√	x*21
√	√	√	x*7	x*7	√	√	√	√	x	√	x*21
x*22	x*22	√	x*22	x*22	√	√	x*22	x*22	x*22	x*22	x*22
√	√	√	x*23	x*23	√*13	x*23	√	√	x*24	√	x*23
√	√	√	x*25	x*25	√*13	x*26	√	√	-	x*26	x*25
√	√	√	√	√	√	√	√	√	√	√	x*27
√	√	√	√	√	√	√	√	√	√	√	x*37
√	√	x*7	x*7	x*7	√	√*32	√	√	√*32	√*32	x*34
√	√	√	√	√	x	√	√	√	√	√	√
√	√	x	x	√	x	√	√	x	√	√	x
√*29	√*29	√*30	√*30	x	x	√*29	√*29	x	√*29	x	x
√	x	√	√	√	√	√	√	x	√	√	x
√	√	√	x*7	x*7	x*7	√	√	√	√	√	x*21
√*35	√*35	√*35	√	√	x*39	√	√*35	√*35	√*35	x*7	x*21
√	√	√	-	-	√	√	√	√	√	√	x*21
√	√	√	√	√	√	√	√	√	√	√	-
√	√	√	√	√	√	√	√	√	√	√	x
x*28	x*28	√	√	√	√	√	x*28	x*28	x*28	x*28	x*28
√	√	√	x*12	x*12	√	√	√	√	√	√	x*7
√	√	√	√	√	√	√	√	√	√	√	x*21
x	x	x	x	x	x*21	x	x	x	x	√	x*7

- *16 Fixed to ★★★ (Best) equivalent
- *17 Fixed to ★★ (Better)
- *18 Fixed to **AWB**
- *19 Fixed to [] (Multiple)
- *20 (Automatic Tracking) is not available
- *21 Fixed to (On)
- *22 Fixed to (Multi-segment metering)
- *23 Fixed to [AUTO]
- *24 The sensitivity is fixed at its minimum value
- *25 Fixed at 125-1600
- *26 Fixed at 125-6400
- *27 Fixed at ±0.0
- *28 Fixed at normal level
- *29 Not available when [Macro Light] is (On)
- *30 Only (Self-portrait Assist) is available.

- *31 Fixed to 1280 x 720
- *32 [Dual] cannot be selected.
- *33 Fixed to [Dual]
- *34 Fixed to [Sensor Shift]
- *35 Fixed to (Off) when the sensitivity is fixed to 3200 or 6400
- *36 Optical zoom and digital zoom are available before shooting. Intelligent Zoom is not available.
- *37 Fixed to [Auto]
- *38 Cannot be selected when the flash mode is (Flash Off + Flash On (2 shots)).
- *39 When the Recorded Pixels other than 2M(16:9) is selected, only the optical zoom is available.

Messages















Messages such as the following may appear on the display during camera operation.

Message	Description
Battery depleted	The battery is exhausted. Charge the battery using the battery charger (p.31).
Memory card full	The SD Memory Card is full and no more images can be saved.
Available memory on card is insufficient to copy the images	Insert a new SD Memory Card or delete unwanted images. (p.34, p.121) Change the recorded pixels or quality level of recorded images and try again (p.128).
Memory card error	Shooting and playback are impossible due to a problem with the SD Memory Card. You may be able to display or copy the images on the card using a computer.
The built-in memory is not formatted	The data in the built-in memory are damaged. Format the built-in memory.
Card is not formatted	The SD Memory Card you have inserted is unformatted or has been formatted on a computer or other device and is not compatible with this camera. Format the SD Memory Card in the camera (p.148).
Card is locked	The SD Memory Card is write-protected (p.7).
Compression error	This message occurs when the camera fails to compress an image. Change the quality level or recorded pixels of the image and try shooting or saving it again.
No image	There are no images on the SD Memory Card or in the built-in memory.
Movie recording stopped	This message appears when the internal temperature of the camera has exceeded normal operating limits while recording a movie.
Deleting	This message appears when deleting an image.
Unable to play back this image	You are trying to play back an image in a format not supported by this camera. You may be able to play it back on another brand of camera or on your computer.
Image folder cannot be created	The largest file number (9999) has been assigned to an image in the largest folder number (999) and no more images can be saved. Insert a new SD Memory Card or format the card/built-in memory (p.148).
Protected	The image you are trying to delete is protected.

Message	Description
Data being recorded	Displayed when you try to switch to  mode while an image is still being recorded, or when the protect setting is being changed. It disappears after the image is recorded or the setting is changed.
Data being processed	Displayed when the camera takes more than five seconds to display an image due to image processing, or when the SD Memory Card or the built-in memory is being formatted.
Built-in memory full	Displayed if the built-in memory is full when saving a file.
No image to be processed	Displayed when there are no images.
This image cannot be processed	Displayed for files that cannot be processed.
No card in the camera	Displayed if no SD Memory Card is inserted when "Image Copy" is selected from the Playback Mode Palette and the OK button is pressed.
Available built-in memory is insufficient to copy the images	Displayed when there is insufficient built-in memory to perform copying.
Cannot process correctly	Displayed when red-eye compensation processing fails.
Not enough battery power remaining to activate Pixel Mapping	Displayed when the battery is too low during Pixel Mapping. Change the battery (p.29).
No more images can be selected	Displayed when you select more than the maximum number of images.
The camera will turn off to prevent damage from overheating	Appears when the temperature inside the camera exceeds the highest limit.

Troubleshooting

Problem	Cause	Remedy
The camera will not turn on	The battery is not installed	Check if a battery is installed. If not, install a battery.
	The battery is installed incorrectly	Check orientation of the battery. Reinsert the battery according to the ⊕ ⊖ symbols in the battery compartment (p.29).
	The battery is exhausted	Charge the battery.
No image appears on the display	The camera is connected to a computer	The display is off when the camera is connected to a computer.
	The camera is connected to a TV	The display is off when the camera is connected to a TV.
	The display is set to off	Press the OK button to turn the display on.
The display is hard to see	The brightness level of the display is set too dark	Adjust the brightness level in [Brightness Level] in the [Setting] menu. (p.160)
	Power Saving function is on	When the Power Saving function is on, the display automatically darkens after a certain amount of time. Press a button to return to the normal brightness level. Select [Off] in [Power Saving] in the [Setting] menu to turn the Power Saving function off (p.161).
The shutter will not release	The flash is charging	Pictures cannot be taken while the flash is charging. Wait until charging is finished.
	There is no available space on the SD Memory Card or in the built-in memory	Insert an SD Memory Card with available space or delete unwanted images (p.34, 121).
	Recording	Wait until recording is finished.
The picture is dark when using the flash	The subject is too far away in a dark environment, such as a night scene	The picture becomes dark if the subject is too far away. Take pictures within the specified flash range.

Problem	Cause	Remedy
The subject is not in focus	The subject is difficult to focus on with autofocus	Lock the focus on an object the same distance away as the subject (by pressing and holding the shutter release button halfway), then aim the camera at your subject and press the shutter release button fully (p.56). Or set the focus manually (p.76).
	The subject is not in the focusing area	Locate the desired subject in the focus frame (focusing area) in the center of the display. If it is difficult to do so, first lock the focus on the desired subject (by pressing and holding the shutter release button halfway), and then move the camera to recompose.
The flash does not discharge	The flash mode is set to  (Flash Off)	Set to  (Auto) or  (Flash On) (p.73).
	The drive mode is set to  ,  , or  ; the focus mode is set to  (Infinity); or the shooting mode is set to  ,  ,  ,  ,  ,  , or  (High Speed Movie).	The flash does not discharge in these modes.



Very occasionally, static electricity may cause camera to malfunction. In this case, remove the battery and install it again. If the camera is then working properly, you can continue using the camera.

Default Settings

The table below lists the factory default settings.

The meaning of the indications for menu items with a default setting is explained below.



Last Memory Setting





- Yes : The current setting (last memory) is saved when the camera is turned off.
- No : The setting returns to the default setting when the camera is turned off.
- * : The last memory setting depends on the [Memory] setting (p.108).
- : N/A

Reset Setting

- Yes : The setting returns to the default setting with the Reset function (p.165).
- No : The setting is saved even after reset.
- : N/A

● [📷 Rec. Mode] Menu Items



Item	Default Setting (Shooting mode: P)	Last Memory Setting	Reset Setting	Page
Image Tone	Bright	Yes	Yes	p.78
Recorded Pixels	 (4608 x 2592)	Yes	Yes	p.79
Quality Level	★★ (Better)	Yes	Yes	p.80
White Balance	AWB (Auto)	*	Yes	p.82
AF Setting	Focusing Area	[] (Multiple)	Yes	p.76
	Auto Macro	<input checked="" type="checkbox"/> (On)	Yes	p.77
	Focus Assist	<input checked="" type="checkbox"/> (On)	Yes	p.78
AE Metering	 (Multi-segment)	*	Yes	p.84
Sensitivity	AUTO (125-1600)	*	Yes	p.85
AUTO ISO Range	125-1600	*	Yes	p.86
EV Compensation	±0.0	*	Yes	p.86
D-Range Setting	Highlight Correction	Auto	Yes	p.87
	Shadow Correction	Auto	Yes	p.87
Pixel Track SR	<input type="checkbox"/> (Off)	Yes	Yes	p.88
Face Detection	 (Face Detection On)	*	Yes	p.89

Item		Default Setting (Shooting mode: P)	Last Memory Setting	Reset Setting	Page
Blink Detection		<input checked="" type="checkbox"/> (On)	Yes	Yes	p.91
Digital Zoom		<input checked="" type="checkbox"/> (On)	*	Yes	p.59
Instant Review		<input checked="" type="checkbox"/> (On)	Yes	Yes	p.91
Memory	Face Detection	<input type="checkbox"/> (Off)	Yes	Yes	p.108
	Flash Mode	<input checked="" type="checkbox"/> (On)	Yes	Yes	
	Drive Mode	<input type="checkbox"/> (Off)	Yes	Yes	
	Focus Mode	<input type="checkbox"/> (Off)	Yes	Yes	
	Zoom Position	<input type="checkbox"/> (Off)	Yes	Yes	
	MF Position	<input type="checkbox"/> (Off)	Yes	Yes	
	White Balance	<input type="checkbox"/> (Off)	Yes	Yes	
	Sensitivity	<input type="checkbox"/> (Off)	Yes	Yes	
	EV Compensation	<input type="checkbox"/> (Off)	Yes	Yes	
	AE Metering	<input type="checkbox"/> (Off)	Yes	Yes	
	Digital Zoom	<input checked="" type="checkbox"/> (On)	Yes	Yes	
	DISPLAY	<input type="checkbox"/> (Off)	Yes	Yes	
File No.	<input checked="" type="checkbox"/> (On)	Yes	Yes		
Green Button		Green mode	Yes	Yes	p.92
Sharpness		 (Normal)	Yes	Yes	p.95
Saturation		 (Normal)	Yes	Yes	p.95
Tone Adjustment		 (B&W)	Yes	Yes	p.95
Contrast		 (Normal)	Yes	Yes	p.95
Date Imprint		Off	Yes	Yes	p.96
IQ Enhancer		<input checked="" type="checkbox"/> (On)	Yes	Yes	p.96
Macro Light	Macro Light	<input checked="" type="checkbox"/> (On)	Yes	Yes	p.97
	Brightness	 (1)	Yes	Yes	

● [Movie] Menu Items

Item		Default Setting	Last Memory Setting	Reset Setting	Page
Recorded Pixels		 (1920 x 1080/30fps)	Yes	Yes	p.102
Movie SR		<input checked="" type="checkbox"/> (On)	Yes	Yes	p.103
Wind Suppression		<input type="checkbox"/> (Off)	Yes	Yes	p.104



● [🔧 Setting] Menu Items

Item		Default Setting	Last Memory Setting	Reset Setting	Page
Sound	Operation Volume	3	Yes	Yes	p.149
	Playback Volume	3	Yes	Yes	
	Startup Sound	Off	Yes	Yes	
	Shutter Sound	1	Yes	Yes	
	Operation Sound	1	Yes	Yes	
	Self-timer Sound	1	Yes	Yes	
Date Adjustment	Date Format (date)	According to initial setting	Yes	No	p.41 p.150
	Date Format (time)	24h	Yes	No	
	Date	01/01/2022	Yes	No	
	Time	According to initial setting	Yes	No	
Alarm	Alarm	Off	Yes	Yes	p.151
	Time	00:00	Yes	Yes	
World Time	Select Time	 (Hometown)	Yes	Yes	p.153
	Destination (City)	According to initial setting	Yes	No	
	Destination (DST)	<input type="checkbox"/> (Off)	Yes	No	
	Hometown (City)	According to initial setting	Yes	No	
	Hometown (DST)	<input type="checkbox"/> (Off)	Yes	No	
Text Size		Standard	Yes	No	p.155
Language/言語		According to initial setting	Yes	No	p.38 p.155
Folder Name		Date	Yes	Yes ^{*1}	p.156
File Name		RIMG	Yes	Yes	p.158
USB Connection		MSC	Yes	Yes	p.168
HDMI Out		Auto	Yes	Yes	p.160
Brightness Level		 (Normal)	Yes	Yes	p.160
Outdoor View Stg.		 (Off)	Yes	Yes	p.160
Power Saving		5 sec.	Yes	Yes	p.161
Auto Power Off		3 min.	Yes	Yes	p.162
Quick Zoom		<input type="checkbox"/> (Off)	Yes	Yes	p.162
Guide Display		<input checked="" type="checkbox"/> (On)	Yes	Yes	p.163
Reset		Cancel	—	—	p.165
Delete All		Cancel	—	—	p.123
Pixel Mapping		Cancel	—	—	p.163

Item		Default Setting	Last Memory Setting	Reset Setting	Page
Startup Shortcut	Playback Mode	<input checked="" type="checkbox"/> (On)	Yes	Yes	p.165
	LED Lighting	<input checked="" type="checkbox"/> (On)	Yes	Yes	p.165
	Clock Display	<input checked="" type="checkbox"/> (On)	Yes	Yes	p.165
Format		Cancel	—	—	p.148











*1 Except the folder name that you created

● Playback Mode Palette Items

Item		Default Setting	Last Memory Setting	Reset Setting	Page
Slideshow	Interval	3 sec.	Yes	Yes	p.117
	Screen Effect	Wipe	Yes	Yes	
	Sound Effect	<input checked="" type="checkbox"/> (On)	Yes	Yes	
Image Rotation		Normal	—	—	p.119
Small Face Filter		Approx. 7%	No	No	p.130
Ink Rubbing Filter		 (Standard)	No	No	p.133
Collage	Recorded Pixels		Yes	Yes	p.134
	Layout		Yes	Yes	
	Background	White	Yes	Yes	
	Select image(s)	—	—	—	
Digital Filter		B&W/Sepia	No	—	p.131
HDR Filter		—	—	—	p.133
Original Frame	Blur	All sides/White	No	—	p.138
	Edge Composite	All sides/White	No	—	
Movie Edit	Save as Still Image	—	—	—	p.142
	Divide Movies	—	—	—	
	Adding title picture	—	—	—	
Red-eye Edit		—	—	—	p.137
Resize	Recorded Pixels	Depending on the picture taken	—	—	p.128
	Quality Level	Depending on the picture taken	—	—	p.128
Cropping		Depending on the picture taken	—	—	p.129
Image Copy		Built-in memory → SD Memory Card	—	—	p.145

Item		Default Setting	Last Memory Setting	Reset Setting	Page
Protect	Single Image	Depending on the picture taken	—	—	p.124
	All Images	Depending on the picture taken	—	—	
Start-up Screen		Default	Yes	Yes	p.164

● Button/Key Operation

Item	Function	Default Setting	Last Memory Setting	Reset Setting	Page
 button	Operation Mode	 Mode	—	—	—
W/T button	Zoom Position	Full wide-angle	*	No	p.57
Four-way controller	 Drive Mode	<input type="checkbox"/> (Standard)	*	Yes	p.67 - p.71
	 Shooting Mode	 (Auto Picture)	Yes	Yes	p.60
	 Flash Mode	 (Auto)	*	Yes	p.73
	 Focus Mode	AF (Standard)	*	Yes	p.75
MENU button	Menu Display	Still Picture Capture Mode: [ Rec. Mode] menu Movie Mode: [ Movie] menu Playback Mode: [ Setting] menu	—	—	p.48
OK button	Information Display	Normal Display	*	Yes	p.21
Green Button	Function Recall	Green mode	Yes	Yes	p.93
Movie button	Operation Mode	Recording starts	—	—	p.101

List of World Time Cities

City: indicates cities that can be set as either the Initial Setting (p.38) or the World Time (p.153).

Region	City name	Region	City name
North America	Honolulu	Africa/West Asia	Istanbul
	Anchorage		Cairo
	Vancouver		Jerusalem
	San Francisco		Nairobi
	Los Angeles		Jeddah
	Calgary		Tehran
	Denver		Dubai
	Chicago		Karachi
	Miami		Kabul
	Toronto		Male
	New York		Delhi
	Halifax		Colombo
	Central and South America		Mexico City
Lima		Dacca	
Santiago		East Asia	Yangon
Caracas			Bangkok
Buenos Aires			Kuala Lumpur
Sao Paulo			Vientiane
Rio de Janeiro	Singapore		
Europe	Lisbon		Phnom Penh
	Madrid	Ho Chi Minh	
	London	Jakarta	
	Paris	Hong Kong	
	Amsterdam	Beijing	
	Milan	Shanghai	
	Rome	Manila	
	Copenhagen	Taipei	
	Berlin	Seoul	
	Prague	Tokyo	
	Stockholm	Guam	
	Budapest	Oceania	Perth
	Warsaw		Adelaide
	Athens		Sydney
	Helsinki		Noumea
	Moscow		Wellington
	Africa/West Asia		Dakar
Algiers			Pago Pago
Johannesburg			

Main Specifications

Type	Fully automatic compact digital camera with built-in zoom lens
Number of Effective Pixels	Approx. 16 megapixels
Image Sensor	1/2.3 inch CMOS
Number of Recorded Pixels	<p>Still 16M (4608 x 3456), 12M 16:9 (3456 x 3456), 12M 16:9 (4608 x 2592), 7M (3072 x 2304), 5M 16:9 (3072 x 1728), 5M (2592 x 1944), 4M 16:9 (2592 x 1464), 3M (2048 x 1536), 2M 16:9 (1920 x 1080), 1024 (1024 x 768), 640 (640 x 480)</p> <p>* 12M 16:9 / 5M 16:9 / 4M 16:9 / 2M 16:9 in Digital Microscope mode. (When the Recorded Pixels other than 2M 16:9 is selected, only the optical zoom is available.)</p> <p>* 5M / 4M 16:9 in Burst Shooting mode.</p> <p>* 3M / 2M / 1280 in Report mode.</p> <p>* 5M / 4M 16:9 in Original Frame mode.</p> <p>Movie 1920 (1920 x 1080/30 fps), 1280 (1280 x 720/60 fps) 1280 (1280 x 720/30 fps)</p>
Sensitivity	AUTO, Manual (ISO 125, 200, 400, 800, 1600, 3200, 6400) * The sensitivity is fixed at AUTO (125-6400) in Digital SR mode.
File Formats	<p>Still JPEG (Exif 2.3), DCF 2.0, PRINT Image Matching III</p> <p>Movie MPEG-4 AVC/H.264, approx. 60 fps/30 fps, PCM system, monaural sound, Movie SR (Movie Shake Reduction)</p>
Image Tone	<p>Still Bright, Natural, Vibrant, Slide Film, Monochrome, Cross Processing</p> <p>* The values that can be set vary depending on the shooting mode.</p>
Quality Level	<p>Still ★★★ (Best), ★★ (Better), ★ (Good)</p> <p>Movie Fixed at ★★★ (Best) *Unchangeable</p>
Storage Media	Built-in memory (approx. 68 MB), SD Memory Card, SDHC Memory Card, SDXC Memory Card (up to 512 GB)

Approximate Image Storage Capacity and Recording Time Still

	Built-in Memory			2 GB SD Memory Card		
	★★★	★★	★	★★★	★★	★
16M (4608 x 3456)	13	23	38	370	653	1078
12M 16:9 (3456 x 3456)	15	30	46	435	853	1307
12M 16:9 (4608 x 2592)	15	30	46	435	853	1307
7M (3072 x 2304)	23	43	69	653	1205	1921
5M 16:9 (3072 x 1728)	27	53	76	778	1499	2119
5M (2592 x 1944)	27	53	76	778	1499	2119
4M 16:9 (2592 x 1464)	36	69	99	1024	1921	2794
3M (2048 x 1536)	43	85	124	1205	2364	3415
2M (1600 x 1200)	69	124	167	1921	3415	4728
2M 16:9 (1920 x 1080)	63	114	167	1756	3235	4728
1280 (1280 x 960)	99	181	256	2794	5122	6830
1024 (1024 x 768)	150	256	335	4098	6830	8782
640 (640 x 480)	311	484	545	8782	12295	15368

- The image storage capacity is for reference only. The actual image storage capacity may vary depending on the SD Memory Card and the subject.
- **2M** (1600 x 1200) and **1280** (1280 x 960) can be set only when  (Report) mode is set.

Movie

	Built-in Memory	2 GB SD Memory Card
1920 (1920 x 1080/30 fps)	34 sec.	17 min. 2 sec.
1280 (1280 x 720/60 fps)	34 sec.	17 min. 2 sec.
1280 (1280 x 720/30 fps)	55 sec.	27 min. 38 sec.

- The above figures are based on our standard shooting conditions and may vary depending on the subject, shooting conditions and type of the SD Memory Card used.
- The maximum length of continuous recording time for a movie is 25 minutes.

White Balance	Auto, Daylight, Shade, Tungsten Light, Fluorescent Light (Daylight Colors/Daylight White/White Light), Manual	
Lens	Focal Length	5.0 - 25.0 mm (approx. 28 - 140 mm in 35 mm format equivalent)
	Maximum Aperture	F3.5 (W) - F5.5 (T)
	Lens Construction	11 elements in 9 groups (5 aspherical elements)
	Zoom Type	Electrically driven
Optical Zoom	5x	
Intelligent Zoom	$\frac{7M}{5M}$: approx. 7.5x, $\frac{5M}{4M}$: approx. 8.9x, $\frac{3M}{3M}$: approx. 11.3x, $\frac{2M}{160}$: approx. 12x, $\frac{1024}{640}$: approx. 22.5x, $\frac{640}{640}$: approx. 36x (when combined with optical zoom)	
Digital Zoom	Max. approx. 7.2x (combines with 5x optical zoom to give zoom magnification equivalent to 36x)	
Motion Blur Reduction	Still	Electronic Shake Reduction (Pixel Track SR), Hi-sensitivity Shake Reduction (Digital SR)
	Movie	Electronic Movie Shake Reduction (Movie SR)
Display	2.7 inch wide-LCD, approx. 230,000 dots (AR coating (cover only))	
Playback Modes	Single-frame, 6-frame, 12-frame, Magnified view (max. 10x, scrollable), Folder Display, Calendar Display, Histogram Display, Highlight/Shadow Area Alert, Select & Delete, Slideshow, Resize, Cropping, Image Copy, Image Rotation, Digital Filter, HDR Filter, Original Frame, Ink Rubbing Filter, Collage, Small Face Filter, Movie Playback/Edit (Save as Still image, Divide, Adding title picture), Red-eye Edit, Protect, Start-up Screen	
Focus Mode	Autofocus, Macro, 1cm Macro, Pan Focus, Infinity, Manual Focus	
Focus	Type	TTL contrast detection system by sensor Multiple (9-point autofocus)/spot/automatic tracking changeable
	Focus Range (From lens face)	Standard : 0.5 m - ∞ (Entire zoom range)
		Macro : 0.1 m - 0.6 m (Entire zoom range)
		1cm Macro : 0.01 m - 0.3 m (Mid-zoom to telephoto)
		* It is possible to switch to Infinity, Pan Focus and Manual Focus.
	* Face Detection AF is available only when the camera recognizes the subject's face.	
	Focus Lock	By half-pressing the shutter release button
Exposure Control	AE Metering	Multi-segment metering, Center-weighted metering, Spot AE metering
	EV Compensation	±2 EV (can be set in 1/3 EV steps)
Face Detection	Detection of up to 32 people's faces (up to 31 face detection frames on the display), Smile Capture, Blink Detection, Self-portrait Assist, Self-portrait Assist + Smile Capture * Face Detection AE is available only when the camera detects the subject's face.	

Pet Detection	Detectable number of pets: 1	
Shooting Mode	Auto Picture, Program, HDR, Handheld Night Snap, Movie, Underwater, Underwater Movie, Digital Microscope, Landscape, Flower, Portrait, Interval Shot, Interval Movie, High Speed Movie, Digital SR, Surf & Snow, Kids, Pet, Sport, Night Scene, Night Scene Portrait, Fireworks, Food, Report, Green	
Digital Filter	B&W/Sepia, Toy Camera, Retro, Color (red, pink, purple, blue, green, yellow), Extract Color (red, green, blue), Color Emphasis (Sky Blue, Fresh Green, Delicate Pink, Autumn Leaves), High Contrast, Starburst (Cross, Heart, Star), Soft, Fish-eye, Brightness, Miniature	
Movie	Continuous Recording Time	Approx. 1 second - 25 minutes (however, only until the built-in memory or SD Memory Card is full)
Shutter Speed	1/4000 sec. - 1/4 sec. (mechanical and electronic shutters), max. 4 sec. (Night Scene mode)	
Built-in Flash	Modes	Auto, Flash Off, Flash On, Auto + Red-eye, Flash On + Red-eye, Macro Light
	Flash Range (Except Macro Light)	Wide-angle: approx. 0.2 - 5.5 m (approx. 0.66 - 18 ft.) (Sensitivity: AUTO) Telephoto: approx. 0.2 - 3.5 m (approx. 0.66 - 11 ft.) (Sensitivity: AUTO)
Drive Mode	Single-frame, Self-timer (10 sec., 2 sec.), Continuous Shooting, Burst Shooting, Remote Control (0 sec., 3 sec.), Auto Bracketing	
Self-timer	Electronic control type, control time: Approx. 10 sec., 2 sec.	
Time Function	World Time	75 cities (28 time zones)
	Clock Display	Clock Display by holding down OK button while camera is turned off (for approx. 10 sec.)
	Alarm	Alarm with simultaneous display of the Clock Display at specified time
Power Source	Rechargeable lithium-ion battery D-LI92	
Battery Life	Image Storage Capacity Approx. 300 pictures	* Recording capacity shows the approximate number of shots recorded during CIPA-compliant testing (at 23°C (73.4°F) with display on and flash used for 50% of the shots). Actual performance may vary according to operating conditions.
	Playback Time Approx. 260 min.	* According to the results of in-house testing.
	Movie Recording Time Approx. 90 min.	* According to the results of in-house testing.
Interfaces	USB 2.0 (Micro-B) /HDMI output terminal (Type D)	
Waterproof and Dustproof Rating	JIS waterproof grade 8 and JIS dustproof grade 6 (IP68) Continuous underwater shooting possible for 2 hours at depth of 14 m.	

Impact Resistance Rating	Our drop test (1.6 m height onto a 5 cm thick plywood surface) complying with MIL-Standard 810F Method 516.5-Shock testing. * Waterproof performance is not guaranteed if the camera is exposed to impact such as being dropped or hit. * The camera is not guaranteed to be free of trouble or damages under every condition.
Dimensions	Approx. 122.5 (W) x 61.5 (H) x 29.5 (D) mm (approx. 4.8 (W) x 2.4 (H) x 1.2 (D) inches) (excluding operating or protruding parts)
Weight	Approx. 173 g (approx. 6.1 oz.) (excluding battery and SD Memory Card) Approx. 194 g (approx. 6.8 oz.) (including battery and SD Memory Card)
Accessories	Rechargeable lithium-ion battery, USB power adapter, USB cable, Strap, Macro stand, Start Guide, Regarding Waterproof, Dustproof, and Shockproof Design

USB Power Adapter AC-U2

Power Supply	100 to 240 VAC (50/60 Hz), 0.2 A
Output	5.0 VDC, 1000 mA, 5.0 W
Average Active Efficiency	76.8 %
No-Load Power Consumption	70 mW
Temperature	10 to 40°C (50 to 104°F)
Dimensions	Approx. 42.5 mm (W) x 22 mm (H) x 66.5 mm (D) (approx. 1.7 in. (W) x 0.9 in. (H) x 2.6 in. (D)) (excluding the power plug)
Weight	Approx. 40 g (approx. 1.4 oz) (excluding the power plug)

Rechargeable Battery D-LI92

Nominal Voltage	3.7 V
Rated Capacity	925 mAh, 3.5 Wh
Operating Temperature	0 to 45°C (32 to 113°F)
Storage Temperature	-20 to 50°C (-4 to 122°F)
Dimensions	Approx. 39.8 mm (W) x 34.2 mm (H) x 6.8 mm (D) (approx. 1.57 in. (W) x 1.35 in. (H) x 0.27 in. (D))
Weight	Approx. 20 g (approx. 0.7 oz)

Warranty Policy

All our cameras purchased through authorized bona fide photographic distribution channels are guaranteed against defects of material or workmanship for a period of twelve months from the date of your purchase. Service will be rendered, and defective parts will be replaced without cost to you within that period, provided the camera does not show evidence of impact, sand or liquid damage, mishandling, tampering, battery or chemical corrosion, operation contrary to operating instructions, or modification by an unauthorized repair shop. The manufacturer or its authorized representatives shall not be liable for any repair or alterations except those made with its written consent and shall not be liable for damages from delay or loss of use or from other indirect or consequential damages of any kind, whether caused by defective material or workmanship or otherwise; and it is expressly agreed that the liability of the manufacturer or its representatives under all guarantees or warranties, whether expressed or implied, is strictly limited to the replacement of parts as herein before provided. No refunds will be made on repairs by non-authorized service facilities.

Procedure During 12-month Warranty Period

Any camera which proves defective during the 12-month warranty period should be returned to the dealer from whom you purchased the camera or to the manufacturer. If there are no representatives of the manufacturer in your country, send the camera to the manufacturer, with postage prepaid. In this case, it will take a considerable length of time before the camera can be returned to you owing to the complicated customs procedures required. If the camera is covered by warranty, repairs will be made and parts replaced free of charge, and the camera will be returned to you upon completion of servicing. If the camera is not covered by warranty, regular charges of the manufacturer or of its representatives will apply. Shipping charges are to be borne by the owner. If your camera was purchased outside of the country where you wish to have it serviced during the warranty period, regular handling and servicing fees may be charged by the manufacturer's representatives in that country. Notwithstanding this, your camera returned to the manufacturer will be serviced free of charge according to this procedure and warranty policy. In any case, however, shipping charges and customs clearance fees to be borne by the sender. To prove the date of your purchase when required, please keep the receipt or bills covering the purchase of your camera for at least a year. Before sending your camera for servicing, please make sure that you are sending it to the manufacturer's authorized representatives or their approved repair shops, unless you are sending it directly to the manufacturer. Always obtain a quotation for the service charge, and only after you accept the quoted service charge, instruct the service station to proceed with the servicing.

- This warranty policy does not affect the customer's statutory rights.
- The local warranty policies available from our distributors in some countries can supersede this warranty policy. Therefore, we recommend that you review the warranty card supplied with your product at the time of purchase, or contact our distributor in your country for more information and to receive a copy of the warranty policy.

Regarding User Registration

In order to better serve you, we request that you complete the user registration, which can be found on our website. Thank you for your cooperation.

<http://www.rioh-imaging.com/registration/>

Notice to Users in CE marking

This product complies with the essential requirements and provisions of EMC Directive 2014/30/EU.

Importer(CE marking) : RICOH IMAGING EUROPE S.A.S.

Parc Tertiaire SILIC 7-9, avenue Robert Schuman - B.P. 70102, 94513 Rungis Cedex, FRANCE

Manufacturer : RICOH IMAGING COMPANY,LTD.

1-3-6, Nakamagome, Ohta-ku, Tokyo 143-8555, JAPAN



The CE Mark is a Directive conformity mark of the European Union.

Notice to Users in UKCA marking

This product complies with the essential requirements and provisions of Electromagnetic Compatibility Regulations 2016.

Manufacturer : RICOH IMAGING COMPANY,LTD.

1-3-6, Nakamagome, Ohta-ku, Tokyo 143-8555, JAPAN



The UKCA Mark is a Regulation conformity mark of the United Kingdom.

For customers in USA

STATEMENT OF FCC COMPLIANCE

This device complies with Part 15 of the FCC Rules. Operation is subject to the following two conditions: (1) This device may not cause harmful interference, and (2) this device must accept any interference received, including interference that may cause undesired operation.

Changes or modifications not approved by the party responsible for compliance could void the user's authority to operate the equipment.

This equipment has been tested and found to comply with the limits for a Class B digital device, pursuant to part 15 of the FCC Rules.

These limits are designed to provide reasonable protection against harmful interference in a residential installation. This equipment generates, uses and can radiate radio frequency energy and, if not installed and used in accordance with the instructions, may cause harmful interference to radio communications.

However, there is no guarantee that interference will not occur in a particular installation.

If this equipment does cause harmful interference to radio or television reception, which can be determined by turning the equipment off and on, the user is encouraged to try to correct the interference by one or more of the following measures:

- Reorient or relocate the receiving antenna.
- Increase the separation between the equipment and receiver.
- Connect the equipment into an outlet on a circuit different from that to which the receiver is connected.

*Consult the dealer or an experienced radio/TV technician for help.

For customers in Canada

Innovation, Science and Economic Development Canada (ISED) Regulatory Compliance Notice.

This Class B digital apparatus complies with Canadian ICES-003 (B).

Pour les utilisateurs au Canada

Avis de conformité à la réglementation d'Innovation, Sciences et Développement économique Canada (ISDE).

Cet appareil numérique de la classe B est conforme à la norme NMB-003 (B) du Canada.

FOR CALIFORNIA, U.S.A. ONLY

Perchlorate Material-special handling may apply. The lithium battery used in this camera contains perchlorate material, which may require special handling. See www.dtsc.ca.gov/hazardouswaste/perchlorate

Declaration of Conformity

According to 47CFR, Parts 2 and 15 for
Class B Personal Computers and Peripherals

We: RICOH IMAGING AMERICAS
CORPORATION

Located at: 2 Gatehall Drive Suite 204, Parsippany,
New Jersey 07054, U.S.A.
Phone: 800-877-0155

Declare under sole responsibility that the product identified herein complies with 47CFR Parts 2 and 15 of the FCC rules as a Class B digital device. Each product marketed is identical to the representative unit tested and found to be compliant with the standards. Records maintained continue to reflect the equipment being produced can be expected to be within the variation accepted, due to quantity production and testing on the statistical basis as required by 47CFR §2.909. Operation is subject to the following two conditions: (1) This device may not cause harmful interference, and (2) This device must accept any interference received, including interference that may cause undesired operation. The above named party is responsible for ensuring that the equipment complies with the standards of 47CFR §15.101 to §15.109.

Product Name: Digital Camera

Model Number: R06020

Contact person: Customer Service Manager

Date and Place: February, 2022, Parsippany

Information for Users on Collection and Disposal of Old Equipment and Used Batteries



1. In the European Union

These symbols on the products, packaging and/or accompanying documents mean that used electrical and electronic equipment and batteries should not be mixed with general household waste.

Used electrical/electronic equipment and batteries must be treated separately and in accordance with legislation that requires proper treatment, recovery and recycling of these products.



By disposing of these products correctly you will help ensure that the waste undergoes the necessary treatment, recovery and recycling and thus prevent potential negative effects on the environment and human health which could otherwise arise due to inappropriate waste handling.

If a chemical symbol is added beneath the symbol shown above, in accordance with the Battery Directive, this indicates that a heavy metal (Hg = Mercury, Cd = Cadmium, Pb = Lead) is present in the battery at a concentration above an applicable threshold specified in the Battery Directive.













































For more information about collection and recycling of used products, please contact your local authorities, your waste disposal service or the point of sale where you purchased the products.







2. In other countries outside the EU

These symbols are only valid in the European Union. If you wish to discard used products, please contact your local authorities or dealer and ask for the correct method of disposal.

For Switzerland: Used electrical/electronic equipment can be returned free of charge to the dealer, even when you don't purchase a new product. Further collection facilities are listed on the home page of www.swico.ch or www.sens.ch.

Symbols



	Mode	47
	Mode	47
	button	43, 45
	[Rec. Mode] Menu	50, 180
	[Movie] Menu	52, 181
	[Setting] Menu	52, 182
	Green Mode	64
	Delete	110, 121
	/Q button	45
	Magnify	120
	T Tele	57
	W Wide	57
	W/T button	43
	Auto Picture	61
	Program	61
	HDR HDR	61
	Handheld Night Snap	61
	Movie	100
	Underwater	98
	Underwater Movie	98
	Digital Microscope	65
	Landscape	61
	Flower	61
	Portrait	61
	Interval Shot	66
	Interval Movie	104
	High Speed Movie	107
	Digital SR	62
	Surf & Snow	62
	Kids	62
	Pet	65
	Sport	62
	Night Scene	62
	Night Scene Portrait	62
	Fireworks	62
	Food	62
	Report	62
	Slideshow	117
	Image Rotation	119
	Small Face Filter	130
	Ink Rubbing Filter	133
	Collage	134
	Digital Filter	131
	HDR HDR Filter	133
	Original Frame	138
	Movie Edit	142

	Red-eye Edit	137
	Resize	128
	Cropping	129
	Image Copy	145
	Protect	124
	Start-up Screen	164

Numerics

1cm Macro 	75
6-Image Display/ 12-Image Display		112

A

AE Metering	84
Alarm	151
Auto + Red-eye  (Flash)	73
Auto Bracketing 	71
AUTO ISO Range	86
Auto Macro	77
Auto Power Off	162
Auto AWB (White Balance)	82
Auto  (Flash)	73
Autofocus area	76
Automatic Tracking	76

B

B&W/Sepia filter	131
Basic mode	64
Battery level indicator	33
Blink Detection	57, 91
Brightness filter	131
Brightness Level	160
Built-in memory	145
Burst Shooting	69

C

Calendar display	114
Camera shake	58
Capture Mode Palette	61
Changing volume	149
Charging a battery	31
Checking the memory card	36
Clock Display	166
Collage	134
Color emphasis filter	131
Color filter	131

Connecting the camera to an AV device	126
Continuous Shooting	69
Contrast	95
Copy	145
Cropping	129



D

Date Adjustment	41, 150
Date Imprint	96
Default settings	180
Delete all	123
Delete 	110, 121
Digital Filter	131
Digital Microscope Mode	65
Digital zoom	59
Display brightness	160
Display language	155
Dividing movies	143
D-Range Setting	87
Drive Mode	67, 69, 71
Dustproof	8

E

EV Compensation	86
Extract color filter	131

F

Face Detection	63, 89
File Name	158
Filters	131
Fish-eye filter	131
Flash Mode	73
Flash Off  (Flash)	73
Flash On  (Flash)	73
Flash On + Red-eye  (Flash)	73
Flower	61
Fluorescent light	83
Fn Setting	93
Focus Assist	78
Focus Mode	75
Focusing	75
Folder display	113
Folder Name	156
Food	62
Format	148
Four-way controller	43, 46
Frame rate	102

G

Green button 	44, 46
Green button setting	92
Green Mode	64
Guide Display	26, 163

H

HDMI	160
HDR Filter	133
High Contrast filter	131
Highlight Correction	87
Histogram	27
Hometown	153





I

Image Copy	145
Image Rotation	119
Image storage capacity	187
Image Tone	78
Infinity 	75
Initial setting	38
Ink Rubbing Filter	133
Installing a battery	29
Instant Review	57, 91
Interval Movie	104
Interval Shot	66
IQ Enhancer	96

L

Landscape	61
Language setting	38, 155
LED Lighting	165, 167

M

Mac	171
Macro 	75
Macro Light	97
Magnify 	120
Manual Focus MF	75, 76
Manual  (White Balance)	83
Memory	108
MENU button	44, 46
Miniature filter	131
Movie button	44, 101
Movie Edit	142
Movie Menu	52, 181
Movie SR (Movie Shake Reduction)	
Function	103
MSC	168
Multi-segment metering 	84

N

Number of pixels 79

O

OK button 44, 46
 Operating the menus 48
 Original Frame 138
 Outdoor View Stg. 160

P

Pan Focus **PF** 75
 Pet Mode 65
 Pixel Mapping 163
 Pixel Track SR 88
 Playback 110, 111
 Playback Mode Palette 116, 183
 Playing back movies 111
 Power button 36, 43, 45
 Power Saving 161
 Press fully
 (shutter release button) 56
 Press halfway
 (shutter release button) 56
 Protect **ON** 124
 PTP 168

Q

Quality Level 80
 Quick Zoom 162

R

Rec. Mode Menu 50, 180
 Recorded Pixels 79, 102
 Recording movies 100
 Red-eye Edit 137
 Red-eye reduction **A** **Q** (Flash) 73
 Regarding waterproof, dustproof, and
 shockproof design 8
 Remote control unit 70
 Report 62
 Reset 165
 Resetting settings 165
 Resize 128
 Retro filter 131
 Rotating 119

S

Saturation 95
 Saving as still picture (movie) 142
 Saving pictures by date 156

Saving settings 108
 SD Memory Card 34
 Select Time 154
 Self-portrait Assist 90
 Self-timer **☺** 67
 Sensitivity 85
 Setting Menu 52, 182
 Shadow Correction 87
 Sharpness 95
 Shooting information 21
 Shooting mode 60
 Shutter release button 43, 45, 56
 Slideshow 117
 Small Face Filter 130
 Soft filter 131
 Sound settings 149
 Sound types 149
 Specifications 186
 Standard **AF** 75
 Starburst filter 131
 Starting-up in playback mode 37
 Start-up screen 164
 Startup Shortcut 165
 Strap 28
 System requirements 170

T

Text Size 155
 Text Stamp 141
 Title picture of movie 144
 Tone Adjustment 95
 Toy Camera filter 131

U

Underwater Mode 98
 Underwater Movie Mode 98
 Underwater shooting 98
 USB Connection 168

W

Waterproof 98
 White Balance 82
 Wind Suppression 104
 Windows 171
 World Time 153

Z

Zoom **W/T** 57

Memo

RICOH IMAGING COMPANY, LTD.

1-3-6, Nakamagome, Ohta-ku, Tokyo 143-8555, JAPAN
(<https://www.ricoh-imaging.co.jp>)

**RICOH IMAGING EUROPE
S.A.S.**

Parc Tertiaire SILIC 7-9, avenue Robert Schuman -
B.P. 70102, 94513 Rungis Cedex, FRANCE
(<https://www.ricoh-imaging.eu>)

**RICOH IMAGING
AMERICAS CORPORATION**

2 Gatehall Drive Suite 204, Parsippany, New Jersey
07054, U.S.A.
(<https://www.us.ricoh-imaging.com>)

**RICOH IMAGING CANADA
INC.**

5560 Explorer Drive Suite 100, Mississauga, Ontario,
L4W 5M3, CANADA
(<https://www.ricoh-imaging.ca>)

**RICOH IMAGING CHINA
CO., LTD.**

Room A 23F Lansheng Building, 2-8 Huaihaizhong
Road, Huangpu District, Shanghai, 200021, CHINA
(<http://www.ricoh-imaging.com.cn>)

<https://www.ricoh-imaging.co.jp/english/>

This contact information may change without notice.
Please check the latest information on our websites.

- Specifications and external dimensions are subject to change without notice.