

NEBULA

For a detailed user manual and more information, scan the QR code or visit:

support.seenebula.com/s



✉ support@seenebula.com
support@anker.com (日本)
support.me@seenebula.com
(For Middle East and Africa Only)
CED-CN@anker.com (中国)

☎ +1 (800) 988 7973 (US/Canada)
+44 (0) 1604 936200 (UK)
+49 (0) 69 9579 7960 (DE)
+971 520750842 (Middle East & Africa)
+971 8000320817 (UAE)
+966 8008500030 (KSA)
+965 22069086 (Kuwait)
+20 8000000826 (Egypt)
+61 3 8331 4800 (AU)
+90 (850) 460 14 14 (TR)
+8 (800) 511-86-23 (RU)
+86 400 0550 036 (中国)
03 4455 7823 (日本)
+82 02-1670-7098 (한국)
+91 18003138831 (India)

© Anker Innovations Limited. All rights reserved.
NEBULA and the NEBULA logo are trademarks of Anker Innovations Limited, registered in the United States and other countries.
Model: D2333

5100500XXXX V01

Use as a Bluetooth Speaker

Press to switch to Bluetooth speaker mode and select **Nebula Mars 3** to connect.

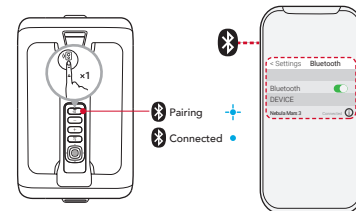

Nebula Connect App

Download the **Nebula Connect** app for the best projector experience.



Important Safety Instructions

- For pluggable equipment, the socket-outlet shall be easily accessible.
- Please ensure you use only the adapter offered by the manufacturer. Using an unauthorized adapter may be dangerous and violate the Terms of Use and product warranty.
- Do not use the product in an environment where the temperature is too high or too low. Never expose the product to strong sunshine or wet environments.
- It is recommended to supply the product in an environment with a temperature that ranges from 5°C~25°C / 41°F~77°F.
- When supplying power, place the device in an environment that has a normal room temperature and good ventilation.
- Do not use the product in any way other than described herein in order to avoid personal injury or property damage.
- User should comply with the laws and regulations of the corresponding countries and regions where the equipment is located (used), pay attention to safety obligations, and strictly prohibit the use of our products or equipment for any illegal purposes. Our company will not be responsible for any violators' legal liability under any circumstances.

Warning:

- Replacing a battery with an incorrect type may defeat safeguards and create danger;
- Disposal of the battery / device in a fire or a hot oven or other source of significant heat, or mechanically crushing, or cutting of the battery / device, may result in an explosion;
- Leaving the battery / device in an extremely hot environment may result in an explosion or leakage of flammable liquids or gases;
- The battery / device subjected to extremely low air pressure may result in an explosion or leakage of flammable liquids or gases.

Attention:

- Le remplacement d'une batterie par un type incorrect peut annuler les protections et créer un danger;
- La mise au rebut de la batterie/du dispositif dans un feu, un four chaud ou toute autre source de chaleur importante, ou l'écrasement mécanique ou le découpage de la batterie/du dispositif, peut entraîner une explosion;
- Laisser la batterie/le dispositif dans un environnement extrêmement chaud peut entraîner une explosion ou une fuite de liquides ou de gaz inflammables;
- La batterie / le dispositif soumis à une pression d'air extrêmement faible peut entraîner une explosion ou une fuite de liquides ou de gaz inflammables.

CAUTION: RISK OF EXPLOSION IF BATTERY IS REPLACED BY AN INCORRECT TYPE. DISPOSE OF USED BATTERIES ACCORDING TO THE INSTRUCTIONS.

ATTENTION RISQUE D'EXPLOSION SI LA BATTERIE EST REMPLACÉE PAR UN TYPE INCORRECT. ÉLIMINER LES BATTERIES USÉES SELON LES INSTRUCTIONS.

Notice (Europe and United Kingdom)

CE This product complies with the radio interference requirements of the European Community.

Declaration of Conformity

Hereby, Anker Innovations Limited declares that this device is in compliance with the essential requirements and other relevant provisions of Directive 2014/53/EU. For the Declaration of Conformity, visit the Web site <https://uk.seenebula.com/>.

UK CA This product complies with the radio interference requirements of the United Kingdom.

Declaration of Conformity

Hereby, Anker Innovations Limited declares that this device is in compliance with Radio Equipment Regulations 2017(SI 2017/1206). The full text of the UK declaration of conformity is available at the following internet address: <https://uk.seenebula.com/>.

The suitable temperature range for the projector and its adapter is for indoor use only. The adapter type is **NSA180EC-19094701** with rated output voltage / current of 19.0VDC / 9.47A.

RF exposure information

The Maximum Permissible Exposure (MPE) level has been calculated based on a distance of d=20 cm

between the device and the human body. To maintain compliance with RF exposure requirement, use product that maintain a 20cm distance between the device and human body.

Frequency bands and power as below:

Function	Bands	Operation Frequency	Power
Bluetooth (Projector)	2.4 GHz	2402-2480 MHz	EIRP 8 dBm
WiFi (Projector)	2.4 GHz	2412-2472 MHz	EIRP 20 dBm
		5150-5250 MHz	EIRP 20 dBm
	5 GHz	5250-5350 MHz	EIRP 20 dBm
		5470-5725 MHz	EIRP 20 dBm
Bluetooth (Remote Control)	2.4 GHz	2402-2480 MHz	EIRP 3.62 dBm

5150~5350 MHz can be used indoors only.

AT	BE	BG	HR	CY	CZ	DK
EE	FI	FR	DE	EL	HU	IE
IT	LV	LT	LU	MT	NL	PL
PT	RO	SK	SI	ES	SE	UK

The following importer is the responsible party (contract for EU matters):

Anker Innovations Deutschland GmbH
Georg-Muche-Strasse 3, 80807 Munich, Germany

The following importer is the responsible party (contract for UK matters):

Anker Technology (UK) Limited I GNR8, 49 Clarendon Road, Watford, Hertfordshire, WD17 1HP, United Kingdom



Your product is designed and manufactured with high quality materials and components, which can be recycled and reused.



This symbol means the product must not be discarded as household waste, and should be delivered to an appropriate collection facility for recycling. Proper disposal and recycling helps protect natural resources, human health, and the environment. For more information on disposal and recycling of this product, contact your local municipality, disposal service, or the shop where you bought this product.

Notice (United States of America)

FCC Statement

This device complies with Part 15 of the FCC Rules. Operation is subject to the following two conditions: (1) this device may not cause harmful interference, and (2) this device must accept any interference received, including interference that may cause undesired operation.

Warning: Changes or modifications not expressly approved by the party responsible for compliance could void the user's authority to operate the equipment.

Note: This equipment has been tested and found to comply with the limits for a Class B digital device, pursuant to Part 15 of the FCC Rules. These limits are designed to provide reasonable protection against harmful interference in a residential installation.

This equipment generates uses and can radiate radio frequency energy and, if not installed and used in accordance with the instructions, may cause harmful interference to radio communications. However, there is no guarantee that interference will not occur in a particular installation. If this equipment does cause harmful interference to radio or television reception, which can be determined by turning the equipment off and on, the user is encouraged to try to correct the interference by one or more of the following measures: (1) Reorient or relocate the receiving antenna. (2) Increase the separation between the equipment and receiver. (3) Connect the equipment into an outlet on a circuit different from that to which the receiver is connected. (4) Consult the dealer or an experienced radio/TV technician for help.

FCC Radio Frequency Exposure Statement
The device has been evaluated to meet general RF exposure requirements. The device can be used in fixed/mobile exposure condition. The min separation distance is 20cm.

Notice: Shielded cables

All connections to other computing devices must be made using shielded cables to maintain compliance with FCC regulations.

The following importer is the responsible party.
Company Name: Fantasia Trading LLC
Address: 5350 Ontario Mills Pkwy, Suite 100, Ontario, CA 91764

Telephone: 1-800-988-7973
5150~5350 MHz can be used indoors only.

Notice (Canada)

IC Statement

This device complies with Industry Canada licence-exempt RSS standard(s). Operation is subject to the following two conditions:

- this device may not cause interference, and
- this device must accept any interference, including interference that may cause undesired operation of the device.

Le présent appareil est conforme aux CNR d'Industrie Canada applicables aux appareils radio exempts de licence. L'exploitation est autorisée aux deux conditions suivantes:

- l'appareil ne doit pas produire de brouillage, et
- l'utilisateur de l'appareil doit accepter tout brouillage radioélectrique subi, même si le brouillage est susceptible d'en compromettre le fonctionnement.

This Class B digital apparatus complies with Canadian ICES-003.

Cet appareil numérique de la classe B est conforme à la norme NMB-003 du Canada.

IC RF Statement

When using the product, maintain a distance of 20cm from the body to ensure compliance with RF exposure requirements. Lors de l'utilisation du produit, maintenez une distance

de 20 cm du corps afin de vous conformer aux exigences en matière d'exposition RF. 5150~5250 MHz can be used indoors only. 5150~5250 MHz peut être utilisé à l'intérieur uniquement.



The Bluetooth® word mark and logos are registered trademarks owned by the Bluetooth SIG, Inc. and any use of such marks by Anker Innovations Limited is under license. Other trademarks and trade names are those of their respective owners.



HDMI, and HDMI logo and High-Definition Multimedia Interface are trademarks or registered trademarks of HDMI licensing LLC in the United States and other countries.



Manufactured under license from Dolby Laboratories. Dolby, Dolby Audio, and the double-D symbol are trademarks of Dolby Laboratories Licensing Corporation.

PAP 22

Raccolta Carta

Anker Innovations Limited | Room 1318-19, Hollywood Plaza, 610 Nathan Road, Mongkok, Kowloon, Hong Kong

At a Glance

1. Front View

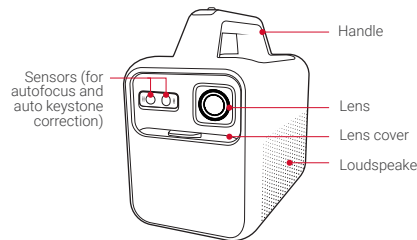

2. Rear View

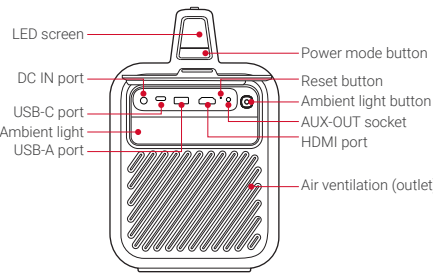

1

3. Top View

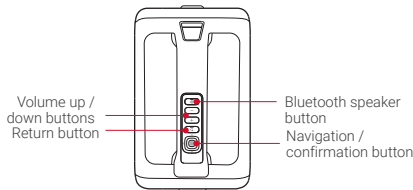

4. Bottom View

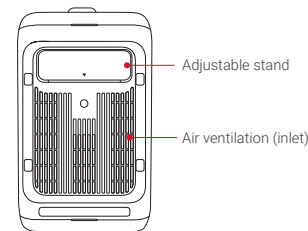

2

Remote Control

1. Overview

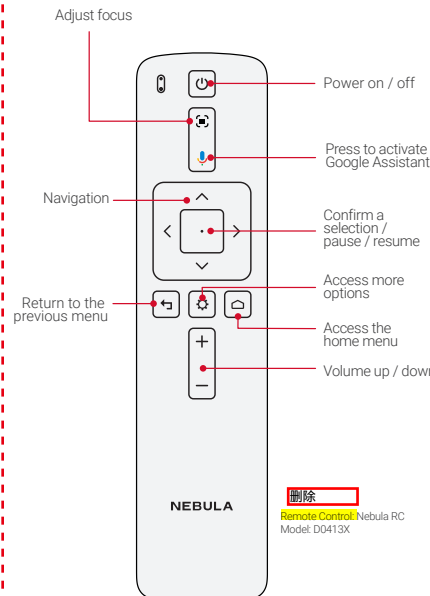

3

2. Prepare the Remote Control

1 Before using for the first time, slide to open the battery compartment, and install two AAA batteries.

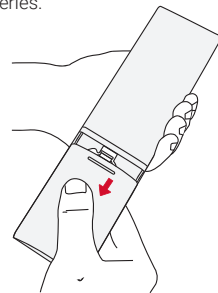

2 To replace the batteries, slide open the battery compartment, insert new batteries (matching the polarity (+/-) as indicated), and close the battery compartment.

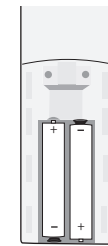

4

Charge Your Projector

Before using for the first time, fully charge the built-in battery using the provided adapter. The LED screen will light up when the battery is charged.

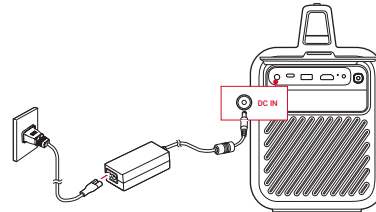

Power On

Slide the lens cover down to turn on the projector, and slide up to turn it off.

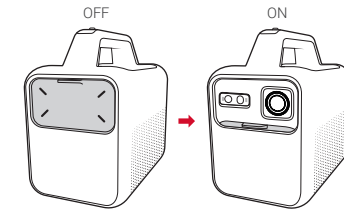

5

Autofocus and Auto Keystone Correction

- Slightly move the projector to enable autofocus and auto keystone correction.
- Press to enable autofocus.

Basic Setup

For first-time use, follow the on-screen instructions to complete the basic setup. Adjust settings in the projector's **Settings** menu if necessary.

Use as a Projector

1. Screen Mirroring

Wirelessly cast movies, games, and music from your phone to Nebula Mars 3.

- 1 Play a video clip on your phone and tap the cast icon on the video screen.
- 2 Select the device **D2333**. The projector will mirror the screen of the connected phone.

6



Make sure Nebula Mars 3 and your phone are connected to the same wireless network.



2. Play from HDMI Playback Devices

Connect to an HDMI playback device such as a TV box, TV stick, DVD player, set-top box (STB), or games console.

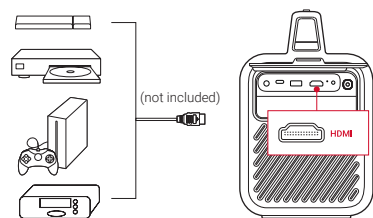

7

3. Play Through External Sound Devices

Connect to external sound output devices including headphones and speakers.

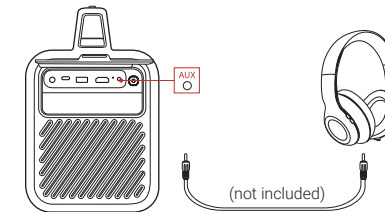

4. Play from a USB Drive

Connect to a USB-A or USB-C drive to enjoy stored music, video, and pictures.

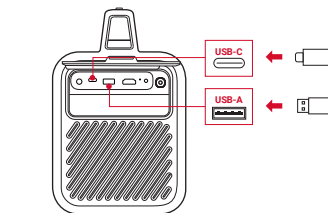

8