

# R20

## MultiTrak

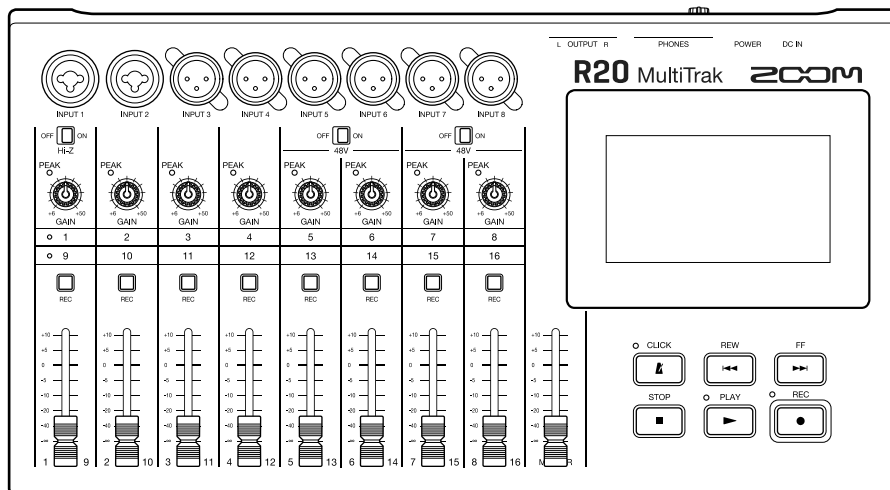

# Operation Manual

You must read the Usage and Safety Precautions before use.

©2022 ZOOM CORPORATION

Copying or reprinting this manual in part or in whole without permission is prohibited.

Product names, registered trademarks and company names in this document are the property of their respective companies. All trademarks and registered trademarks in this document are for identification purposes only and are not intended to infringe on the copyrights of their respective owners.

Proper display is not possible on grayscale devices.

# Notes about this Operation Manual

---

You might need this manual in the future. Always keep it in a place where you can access it easily. The contents of this document and the specifications of the product could be changed without notice.

- Windows® is a trademark or registered trademark of Microsoft® Corporation.
- iPad, iPadOS and Mac are trademarks of Apple Inc.
- App Store is a service mark of Apple Inc.
- iOS is a trademark or registered trademark of Cisco Systems, Inc. (USA).
- The SD, SDHC and SDXC logos are trademarks.
- Recording from copyrighted sources, including CDs, records, tapes, live performances, video works and broadcasts, without permission of the copyright holder for any purpose other than personal use is prohibited by law. Zoom Corporation will not assume any responsibility related to infringements of copyrights.

# Contents

---

Notes about this Operation Manual.....	2
R20 overview.....	6
Terms used in this manual.....	6
Functions of parts.....	7
Connection example.....	11
Touchscreen display.....	13
Home Screen overview.....	13
Control Bar overview.....	17
Touchscreen operation overview.....	19
Making preparations.....	23
Inserting SD cards.....	23
Connecting output devices.....	24
Connecting the AC adapter.....	25
Turning the power on/off.....	26
Setting the date and time (first time starting up).....	28
Opening projects.....	30
Creating new projects.....	31
Opening a project.....	35
Changing project settings.....	37
Opening the Project Settings Screen.....	37
Changing project tempos.....	38
Changing project time signatures.....	39
Setting the metronome.....	40
Changing the snap setting.....	44
Setting the project volume.....	44
Using the tuner.....	45
Selecting the tuner type.....	46
Setting the standard pitch of the tuner.....	47
Using flat tunings.....	47
Recording.....	48
Recording process.....	48
Making input settings.....	49
Making track settings.....	54
Using effects.....	63
Editing patch memories.....	66
Recording.....	72
Using internal rhythm loops.....	74
Using the synthesizer.....	77
Selecting the synth sound.....	77
Recording.....	79

Playing projects.....	80
Editing projects.....	82
Editing regions.....	82
Editing waveforms (audio/rhythm regions).....	98
Editing notes (synth regions).....	103
Editing tracks.....	108
Using markers.....	114
Mixing projects.....	120
Checking track levels.....	120
Muting tracks.....	122
Listening to selected tracks only (soloing).....	123
Adjusting volume levels.....	124
Switching controlled tracks.....	126
Adjusting the panning, EQ and effects of tracks.....	127
Mixing down.....	128
Managing projects.....	129
SD card folder and file structure.....	129
USB flash drive folder and file structure.....	131
Opening the Project Option Menu.....	133
Changing project names.....	135
Duplicating projects.....	136
Checking project information.....	137
Deleting projects.....	138
Rendering projects as WAV files.....	139
Saving projects to USB flash drives.....	141
Importing projects from USB flash drives.....	142
Using as an audio interface.....	144
Installing drivers.....	144
Connecting computers, smartphones and tablets.....	145
Making audio interface settings.....	148
Using the R20 as a control surface.....	151
Enabling control surface use.....	151
Making DAW settings.....	152
R20 functions.....	152
Using Guitar Lab.....	153
Connecting to a computer.....	153
Using MIDI keyboards.....	156
Connecting MIDI keyboards.....	156
Setting the Auto Power Off function.....	158
Setting the date and time.....	159
Adjusting the touchscreen brightness.....	161
Managing SD cards.....	162
Checking SD card information.....	162
Testing SD card performance.....	163



Formatting SD cards.....	165
Using as a card reader.....	167
Restoring default setting values.....	170
Managing the firmware.....	172
Checking the firmware versions.....	172
Updating.....	172
Appendix.....	173
Troubleshooting.....	173
Block diagram.....	174
MIDI implementation chart.....	175
Specifications.....	176

# R20 overview

---

## Terms used in this manual

### Multitrack recorder (MTR)

A recorder that can edit multiple tracks separately is called a multitrack recorder (MTR). The R20 can simultaneously record up to 8 tracks and simultaneously play up to 16 tracks, making it ideal for recording entire bands as well as drum sets.

### Project

The R20 manages recording and playback data for a single song in a unit called a project. The audio files assigned to tracks and settings, including for panning and faders, are saved in project files. Up to 1000 projects can be created on a single card.

### Region

The data from a single recording is managed in units called regions for each track. Regions for audio recordings and rhythms are shown as waveforms while synthesizer regions are shown as performance data (MIDI notes). Moreover, WAV and MIDI files on SD cards and USB flash drives can be added as regions.

### Snap

This function adjusts regions to a grid when they are moved or edited. This enables editing to be conducted efficiently.

### MIDI file

This type of file contains MIDI performance data. The R20 can load MIDI files and add them as synth regions.

### Effect

A wide variety of effects can be applied to sounds, including distortion, chorus and reverb. By adjusting effect parameters, you can create your own original sounds.

### Patch memory

Patch memories store the effects used, their on/off states and parameter settings, allowing easy recall. Effects are saved and recalled in units of patch memories. Up to 3 effects can be added to a patch memory, and up to 50 patch memories can be stored.

# Functions of parts

Top

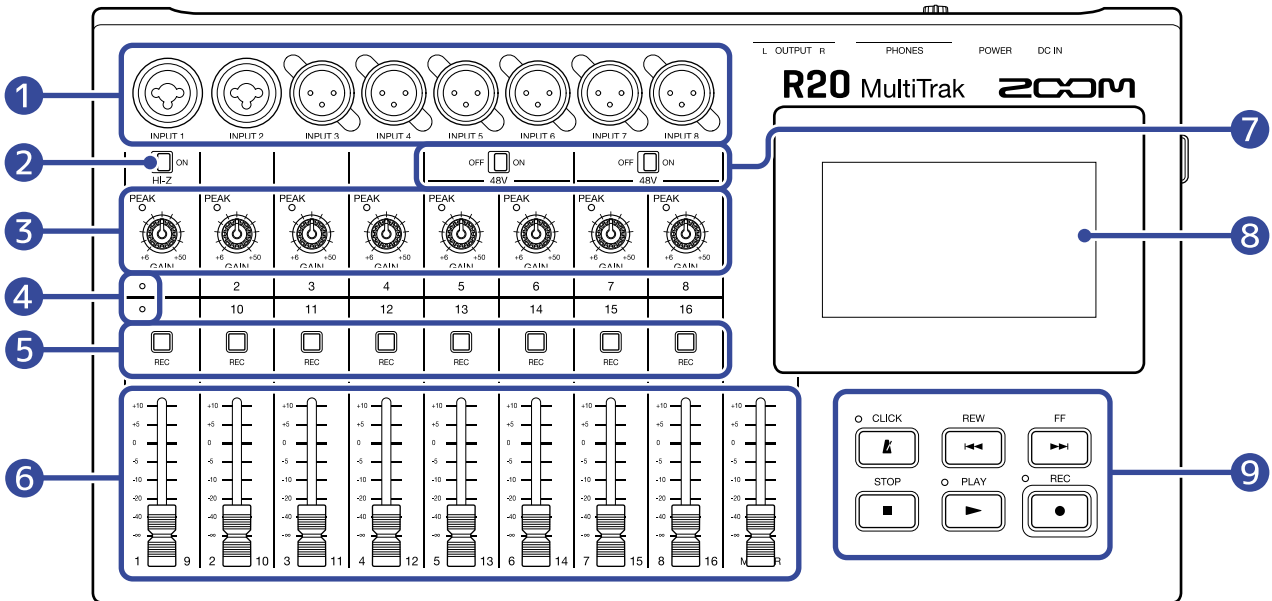

## 1 Input jacks

Use INPUTS 1 and 2 to connect mics, keyboards and guitars. These support XLR and 1/4-inch phone (unbalanced) plugs.

Use INPUTS 3–8 to connect mics and keyboards. These support XLR plugs.

## 2 Hi-Z switch

Turn Hi-Z on/off for INPUT 1. Turn it on as necessary for the connected guitar or bass.

## 3 Input PEAK indicators/GAIN knobs

Use the input GAIN knobs to adjust input signals. Adjust them so that the PEAK indicators do not light.

## 4 Track indicators

These show whether the channel inputs and the faders are connected to tracks 1–8 or 9–16.

## 5 Track REC buttons

Press these buttons to enable recording on tracks. They light red when enabled.

## 6 Channel/MASTER faders

Channel faders: These adjust individual track signal levels in a range from  $-\infty$  to +10 dB.

MASTER fader: This adjusts the signal levels of the MASTER track, which is a stereo mix of the individual tracks, in a range from  $-\infty$  to +10 dB.

## 7 PHANTOM switches

These turn +48V phantom power on/off. Turn these on when, for example, connecting condenser mics that support phantom power to INPUTS 5–8.

## 8 Touchscreen

This shows various types of information and is operated by touch.

## 9 Other buttons



This turns the metronome on/off. The indicator lights when it is on.



This moves the playback position one ruler unit back. Press and hold to search backward.



This moves the playback position one ruler unit forward. Press and hold to search forward.



Press this to stop recording and playback. Press when stopped to move the recording/playback position to the beginning of the project.



Press to start/pause playback of recorded files. The indicator lights during playback.



Press to start recording. The indicator lights during recording.

## Side

---

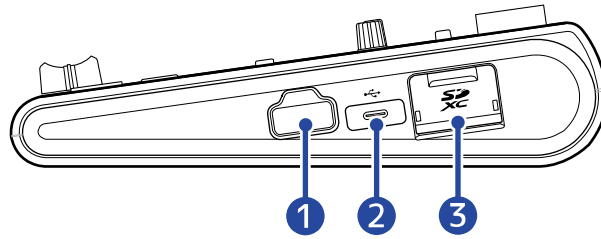

### 1 REMOTE jack

Connect a ZOOM BTA-1 or other dedicated wireless adapter here.

### 2 USB (Type-C) port

Using this, projects can be copied to and imported from USB flash drives. USB MIDI keyboards can also be connected and used to play synth sounds.

Connecting to a computer also makes the following possible.

- Using the R20 as an audio interface
- Using Guitar Lab to replace R20 effects
- Using the R20 as a card reader

### 3 SD card slot

This supports cards that meet SDHC/SDXC specifications.

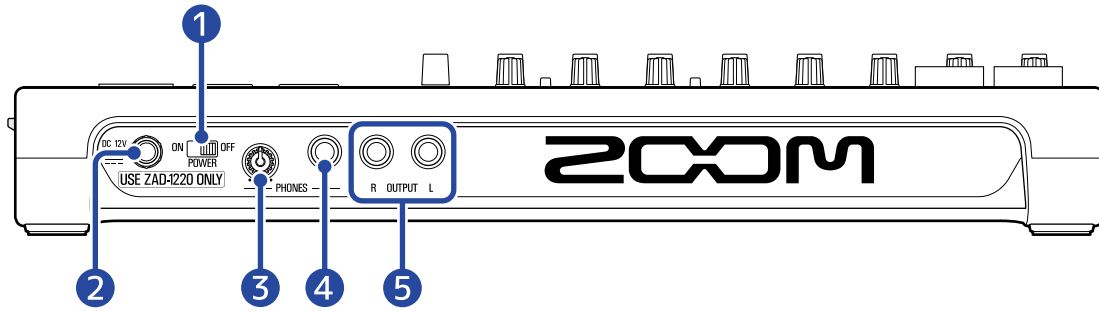

- 1 POWER switch**  
This turns the R20 on and off.  
When switched to OFF, the current mixer settings are automatically saved in the R20 and in the settings file in the project folder on the SD card.
- 2 DC 12V AC adapter connector**  
Connect the dedicated AC adapter (ZOOM ZAD-1220) here.
- 3 PHONES output volume knob**  
Use to adjust the headphone volume.
- 4 PHONES output jack**  
Connect headphones here.
- 5 OUTPUT jacks**  
Connect these to a power amplifier, a PA system or powered monitor speakers, for example.

# Connection example

This is an example of connections to record a band in a studio.

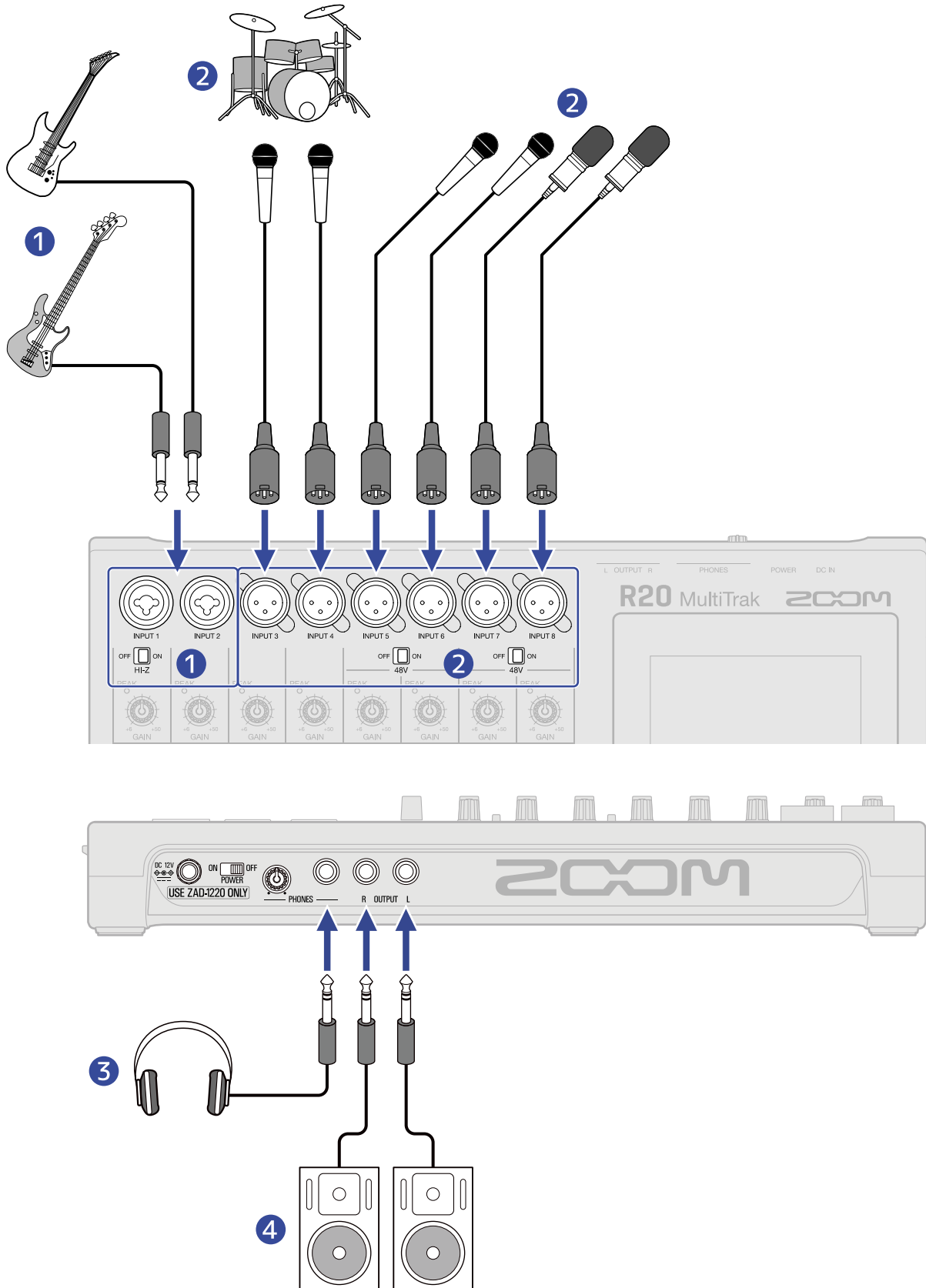

## 1 Guitars and basses

When directly connecting a guitar or bass with passive pickups, use INPUT 1 and set  to ON.

When connecting a guitar or bass with active pickups or through an effect to the R20, use either INPUT 1 or 2. In this case, set  to OFF when connecting to INPUT 1.

## 2 Mics for lead and backing vocals, drums and other sound sources

Dynamic mics can be connected to INPUTS 3 and 4.

For INPUTS 5–8, set  according to the type of mic connected.

- Dynamic mic: OFF
- Condenser mic: ON

## 3 Headphones

## 4 Powered monitors



# Touchscreen display

The R20 shows information necessary for operation on the touchscreen. Tap and slide on the screen to conduct various operations, including selecting, adjusting and editing. The display can also be zoomed in/out by pinching in/out.

This section explains various screens shown on the R20.

## Home Screen overview

This appears on the touchscreen when the R20 power is turned on. The Home Screen has two views: Track View and Level Meter View. Switch between them as needed during operation.

## Track View Screen

This is the normal recording/editing screen.

Since recorded waveforms and their positions can be examined easily, this is useful for thinking about song structure and editing.

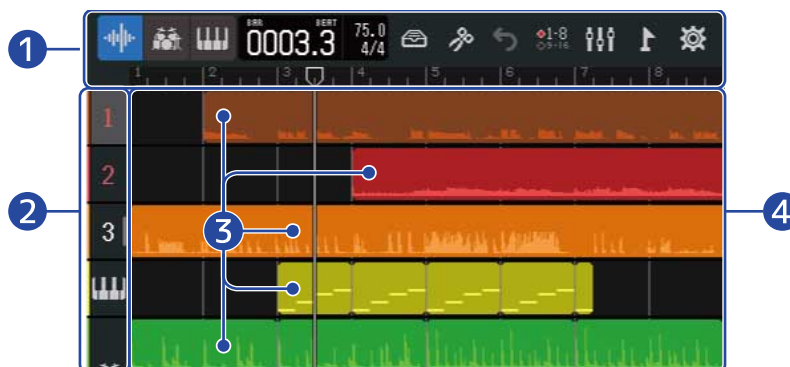



### 1 Control Bar

This shows the recording/playback position and various buttons. See the [Control Bar overview](#) for details.

### 2 Track Headers

These show track numbers and types. Tap this to select a track, highlighting it. Tracks armed for recording are shown in red.

- **1** - **16** : Audio tracks  
These show regions with recorded audio.
-  : Rhythm track  
This shows rhythm loop regions.
-  : Synth track  
This shows synth (MIDI data) regions.

Slide the Track Headers right to open the mixer. When the mixer is open, slide the Track Headers left to close it.

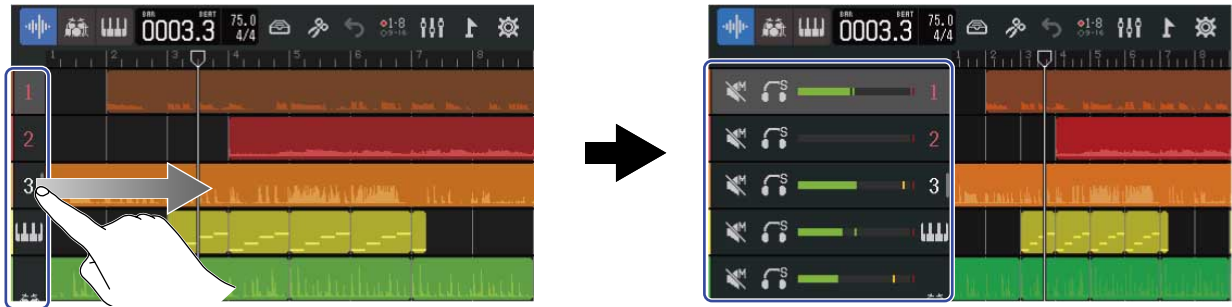

Use the mixer to check the mute (→ [Muting tracks](#)), solo (→ [Listening to selected tracks only \(soloing\)](#)) and volume settings of each track.

### 3 Regions

Audio and rhythm regions are shown as waveforms while synthesizer regions are shown as notes. See [Editing regions](#) for details about region operations, including moving, adding, deleting and dividing them.

#### NOTE:

The maximum numbers of regions in a single project are as follows.

- Total number of audio and rhythm regions: 50
- Synth regions: 80

### 4 Tracks

These show regions.

The display can be changed by doing the following.

- Pinch in horizontally: Shorten the timeline display (This enables showing many bars at the same time.)

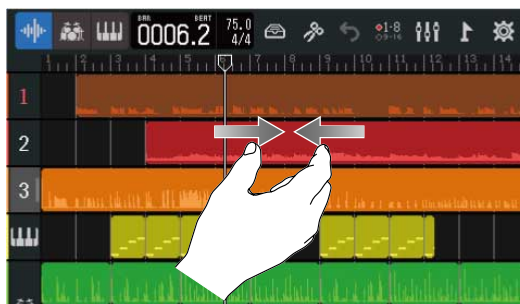

- Pinch out horizontally: Lengthen the timeline display (This enables displaying more detail.)

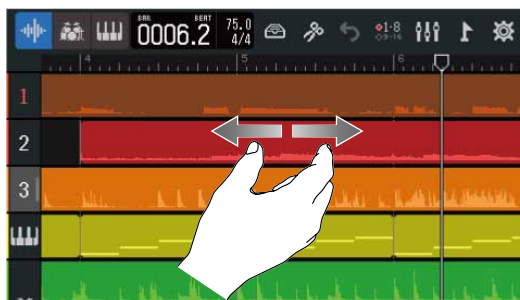

- Slide up, down, left or right: Do this to show tracks that were hidden and to change the part of the timeline that is visible.



# Level Meter View Screen

This screen shows the level meters and faders for all tracks.

This screen makes observing the volume of all tracks easy, so it is useful for recording multiple channels simultaneously and balancing the mix.

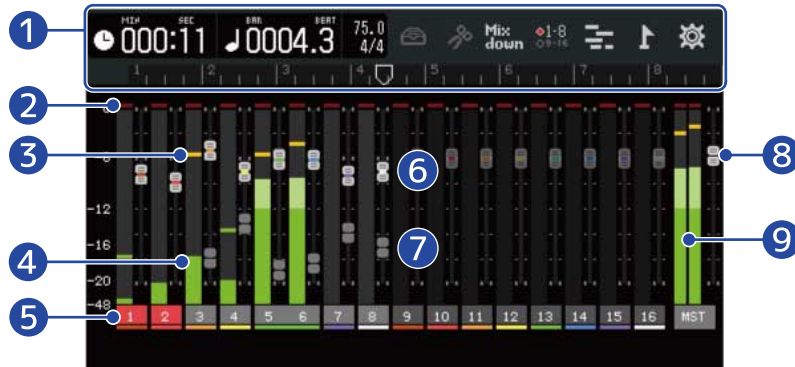

## 1 Control Bar

This shows the recording/playback position and various buttons. See the [Control Bar overview](#) for details.

## 2 Clipping indicators

These light red if input/playback signal levels are clipping after fader adjustment.

Pressing , starting recording and changing screens will clear these indicators.

## 3 Peak indicators

These retain the peak levels of input/playback signals for a set amount of time after fader adjustment.

## 4 Track level meters

These show the input/playback signal levels after fader adjustment.

## 5 Tracks

These show the track numbers. Tracks armed for recording are shown in red.

Tap a track to open the Track Settings Screen

## 6 Track faders

These show the current fader position settings.

## 7 Track ghost faders

When the positions of physical faders and fader settings are different because tracks have been switched, for example, these show the physical fader positions.

To change the fader setting value, move the fader on the unit to the current fader position. This will cause it to reflect the unit fader position.

## 8 MASTER fader

This shows the MASTER fader position.

## 9 MASTER level meters

These show the MASTER track levels.

# Control Bar overview

The Control Bar is shown at the top of the Track View Screen and Level Meter View Screen. Along with showing the current bar position, tempo and time signature, other features include buttons for various settings.

## Track View Screen

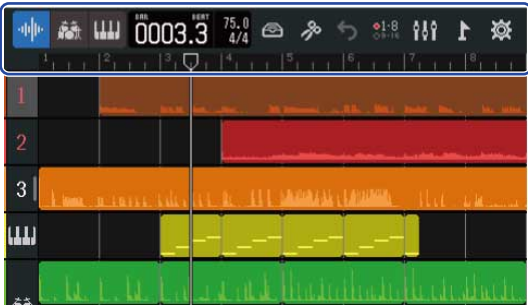

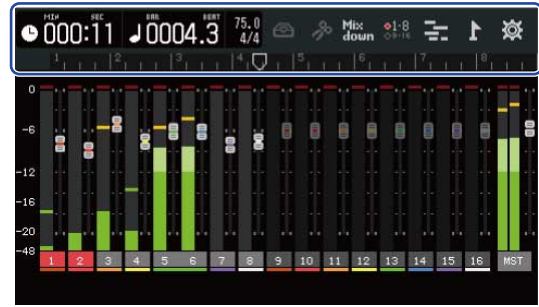

## Level Meter View Screen



### 1 (Track View Screen only): Track Type Buttons

The selected track type can be switched.

- **1 - 16** : Audio tracks
-  : Rhythm track
-  : Synth track

### **001:01** (Level Meter View Screen only): Recording/playback time

This shows the time (in minutes and seconds) of the recording/playback position.

### 2 **0001.1** Recording/playback bars and beats

This shows the bar and beat of the recording/playback position.



### 3 **120.0** **4/4** Tempo and time signature

This shows the current tempo and time signature settings.



This can be tapped to open the Project Settings Screen.

### 4 Library button

- When the track type is **1 - 16**, this opens the Patch Memory Selection Screen.



- When the track type is , this opens the Rhythm Loop Selection Screen.
- When the track type is , this opens the Synth Type Selection Screen.

#### 5 Edit button

- When the track type is **1** – **16** or , this opens the Wave Editor Screen.
- When the track type is , this opens the Piano Roll Screen.

#### 6 (Track View Screen only) UNDO/REDO button

This undoes the last operation. This can be used with the following operations.  
Recording, track deletion/swapping, region deletion/trimming/division/movement



-  : This undoes the last operation (UNDO function).  
(When  is shown, the UNDO function cannot be used.)
-  : This redoes the undone operation. (REDO function)

#### (Level Meter View Screen only) Mixdown button

Use this to mix down recordings.



#### 7 Track Switching button

Select which tracks receive audio from INPUTS 1–8 and can be operated with the physical controls.

-  Tracks 1–8 can be operated.
-  Tracks 9–16 can be operated.

#### 8 Screen Switching button

This switches between the Track View Screen and Level Meter View Screen.

-  : This opens the Level Meter View Screen.
-  : This opens the Track View Screen.

#### 9 Marker button

This opens the Marker Menu.

#### 10 Project Settings button

This opens the Project Settings Screen.

#### 11 Ruler

This shows bars, beats, the recording/playback header and markers.  
Pinch in/out horizontally to zoom out/in on the timeline.

## 12 Recording/playback Header

This shows the recording/playback position. During recording, it appears red. During playback, drag this horizontally to change the playback position.

# Touchscreen operation overview

## Operations on various screens

Tap, swipe, slide and pinch in/out to operate the touchscreen.

### Tap: Select

Tap a value you want to set. The current setting value is shown in blue.

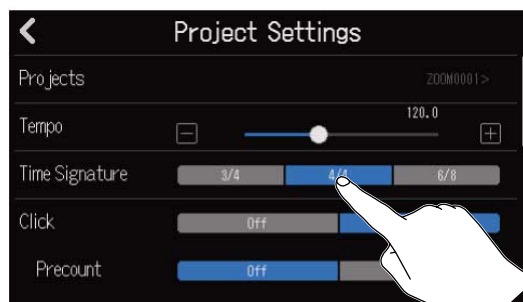

### Tap: Change settings

Tap  and  to change settings.



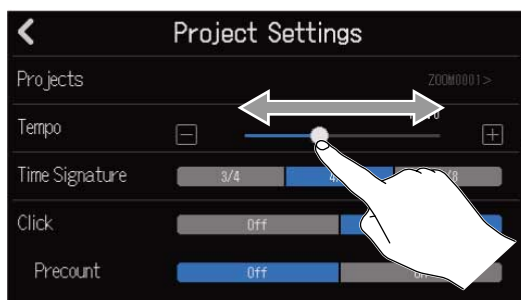

### Slide: Adjust

While touching a slider, move it horizontally to adjust the setting value.



---

**HINT:**

- Tap  or  at the ends of the slider to change the value by 1.
  - Double-tap a slider to reset it to its initial value.
-



Slide: Scroll through items

While touching the display, slide vertically to scroll.

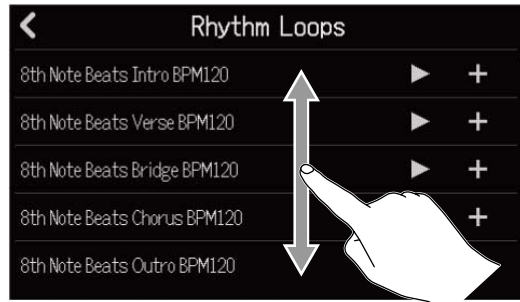

Pinch in/out: Zoom out/in on the timeline

Pinch in



Pinch out



Returning to the previous screen/Home Screen (Track View Screen/Level Meter View Screen)

Tap  at the top left of the screen.

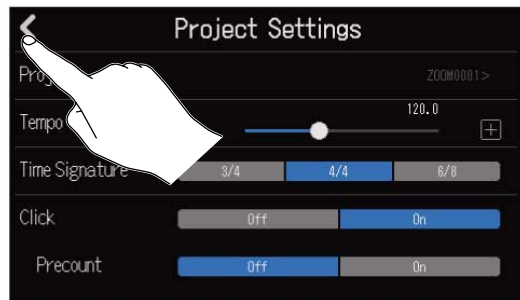

To return to the Home Screen, tap  repeatedly until it opens.

# Character Input Screen overview

The Character Input Screen appears on the touchscreen to enable file names to be input and edited, for example.

Tap the keyboard to input characters.

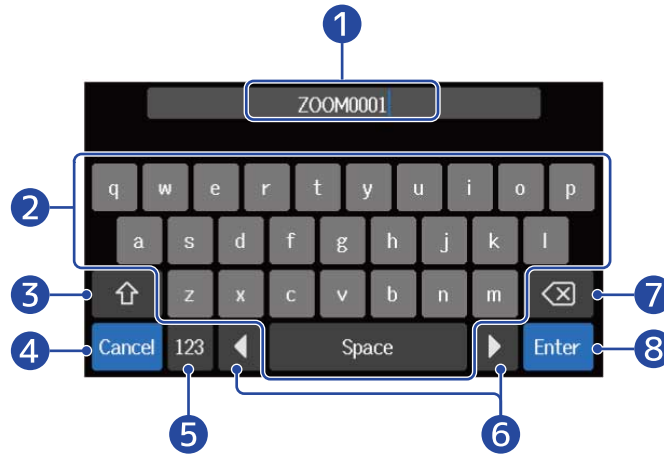

- 1 Character input area  
A cursor shows the input position.
- 2 Input characters
- 3 Switch between uppercase and lowercase
- 4 Cancel input  
This reopens the previous screen.
- 5 Change character type
- 6 Move the cursor
- 7 Delete a character
- 8 Confirm input  
This confirms input.

**NOTE:**

The characters and symbols that can be used are as follows.

! # \$ ' ( ) + , - ; = @ [ ] ^ \_ ` { } ~ (space) A-Z, a-z, 0-9

# Making preparations

## Inserting SD cards

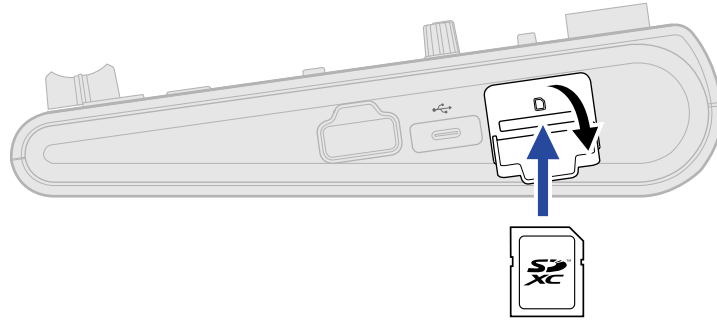

- 1.** Turn the power off and then open the SD card slot cover.
- 2.** Insert the SD card into the SD card slot.  
To remove an SD card, push it further into the slot and then pull it out.

### NOTE:

- Cards that conform to SDHC and SDXC specifications are supported.
- Always make certain that the power is off when inserting or removing SD cards. Inserting or removing a card while the power is on could result in data loss.
- When inserting an SD card, be sure to insert the correct end with the top side up.
- Recording and playback are not possible when an SD card is not loaded in the R20.
- After purchasing a new SD card, always format it using the R20 to maximize performance. (→ [Formatting SD cards](#))

# Connecting output devices

Powered monitors and headphones can be connected for checking the sound.

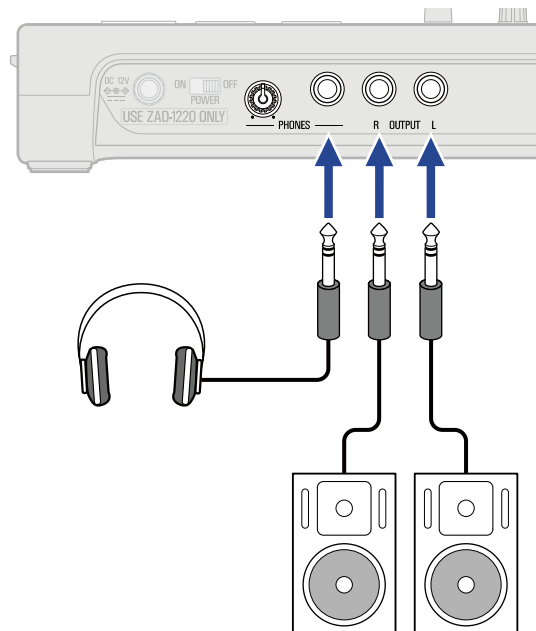

Use  to adjust the headphone volume.

## **NOTE:**

Turn power off powered monitors before connecting them.

## **HINT:**

The OUTPUT jacks support balanced output.

## Connecting the AC adapter

1. Connect the cable of the dedicated AC adapter (ZAD-1220) to the DC 12V AC adapter connector and tighten the screw lock to secure it. Then, plug the AC adapter into an outlet.

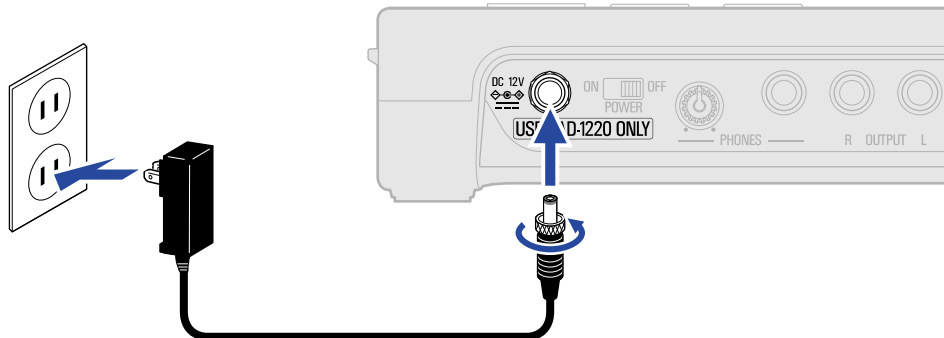

### NOTE:

Tighten until the screw lock cannot be turned more. Power will not be supplied if this is not tightened completely.

# Turning the power on/off

## Turning the power on

1. Confirm that the output devices connected to the R20 are turned off.
2. Set all  knobs and faders to their minimum values.

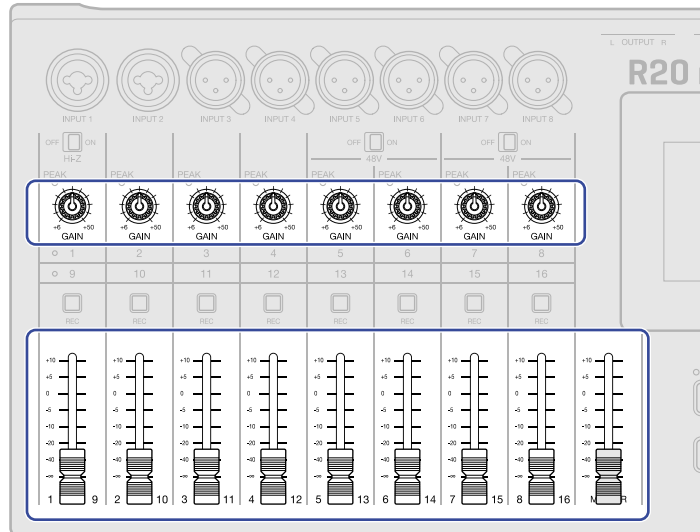

3. Set  to ON.

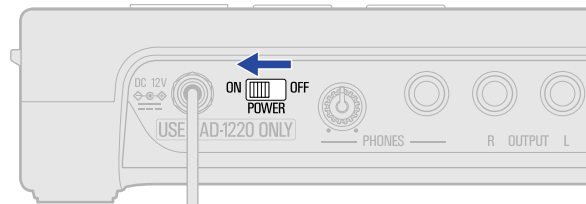

This turns the R20 power on, opening the Projects Screen (→ [Opening projects](#)) or Home Screen (→ [Home Screen overview](#)) on the touchscreen.

The first time the power is turned on after purchase, as well as after the R20 has been reset to factory defaults, the Date/Time Setting Screen will open. Set the date and time when it does. (→ [Setting the date and time \(first time starting up\)](#))

4. Turn on the output devices connected to the R20.

**NOTE:**

- The power will automatically turn off if it is unused for 10 hours. To keep the power on at all times, disable the automatic power saving function. (→ [Setting the Auto Power Off function](#))
- If “No SD card!” appears on the display, confirm that an SD card is inserted properly. (→ [Inserting SD cards](#))
- If “Invalid SD card!” appears on the display, the card is not formatted correctly. Format the SD card (→ [Formatting SD cards](#)) or load a different SD card (→ [Inserting SD cards](#)).

## Turning the power off

---

**1.** Minimize the volume of output devices connected to the R20.

**2.** Turn off the output devices connected to the R20.

**3.** Set  to OFF.



The touchscreen display will turn off.

**NOTE:**

After setting  to OFF, important data will be saved. Do not disconnect the AC adapter while “Please wait. Saving data...” appears on the display.

# Setting the date and time (first time starting up)

The first time the power is turned on after purchase, set the date and time when the Date/Time Setting Screen opens. This is used to add the date and time to recorded files.

1. Tap  /  to set the date and time.

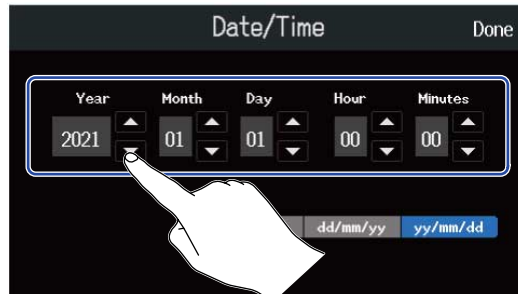

2. Tap the displayed date format to use.

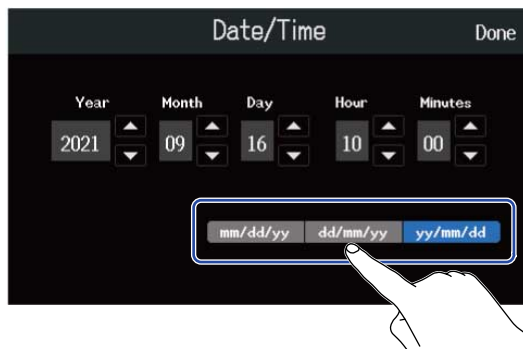

- mm/dd/yy: month/day/year
- dd/mm/yy: day/month/year
- yy/mm/dd: year/month/day

3. Tap "Done".



This confirms the set date and time and opens the Projects Screen. Create a new project. (→ [Creating new projects using templates](#) and [Creating empty projects using specific settings](#))

## NOTE:

If power is not supplied by an AC adapter for a long time, date and time settings will be reset. If the date and time setting screen appears during startup, set them again.



---

**HINT:**

- The date and time setting can also be changed later from the Menu Screen (→ [Setting the date and time](#)).
-

# Opening projects

The R20 saves and manages recording and playback data in units called projects.

A list of projects is shown on the Projects Screen. Tap a project to select it for recording, playback and editing. New projects can also be created on the Projects Screen.

Follow these steps to open the Projects Screen.

1. Tap  on the Home Screen (Track View Screen/Level Meter View Screen).

Track View Screen



Level Meter View Screen

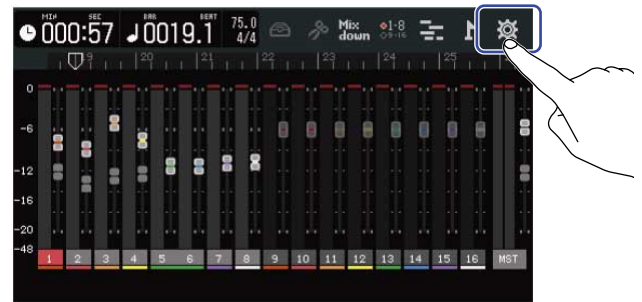

2. Tap "Projects".

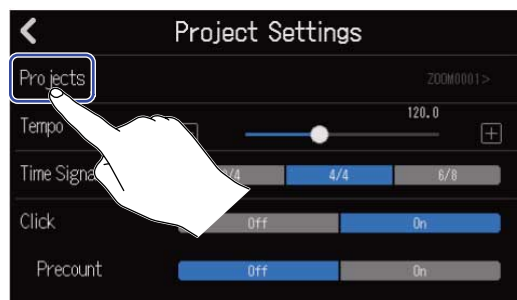

This opens the Projects Screen.



# Creating new projects

Templates that already have rhythm loops included can be selected for various genres to create projects that make starting a music project easy. Projects can also be made by first setting the tempo, time signature and bit depth.

## NOTE:

- Up to 1000 projects can be created on a single card.
- Projects are saved automatically at the following times.
  - When the Projects Screen is opened from another screen
  - When recording completes
  - When the power is turned off
  - When a new project is created
  - When the Project Settings Screen is closed

## Creating new projects using templates

Projects can be created from templates for various genres that have rhythm loops assigned to them in advance.

Templates have been prepared for popular genres including rock, funk and hip-hop.

1. Tap "Templates" on the Projects Screen.

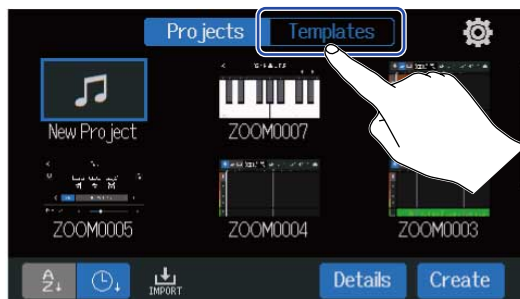

2. Tap the desired genre.

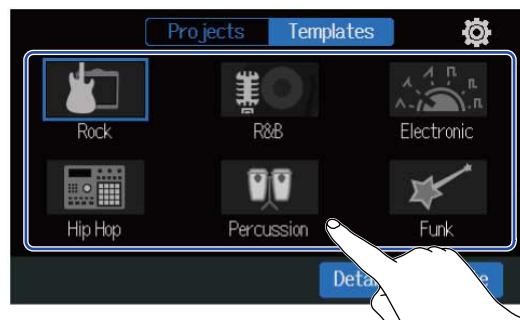

The selected genre will be framed in blue.

### 3. Tap "Create".

This will create a new project and open the Track View Screen, showing the rhythm loop for the selected genre.

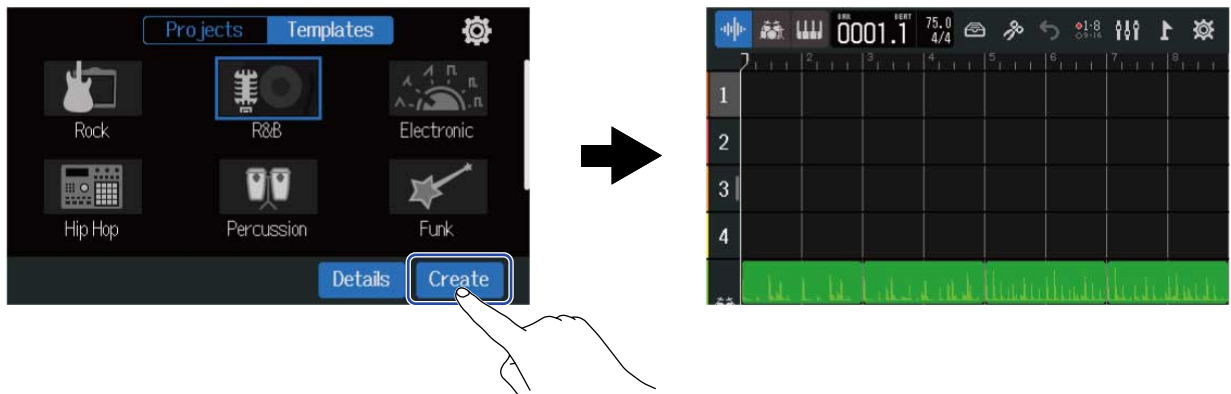

#### HINT:

- Projects will be named "ZOOM0001" - "ZOOM9999". Project names can be changed later. (→ [Changing project names](#))
- Tap "Details" to set the bit depth before creating a project.

## Creating empty projects using specific settings

Projects can be made after setting the tempo, time signature and bit depth. The tempo and time signature can also be changed later from the settings.

### 1. Tap "Projects" on the Projects Screen.

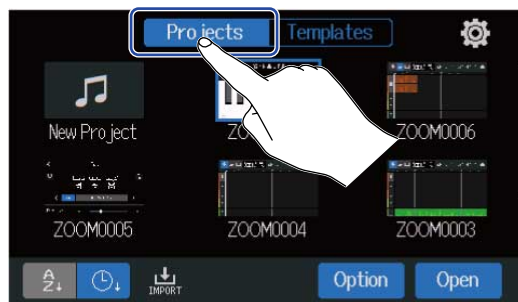

### 2. Tap "New Project" to select it.



### 3. Tap “Details”.

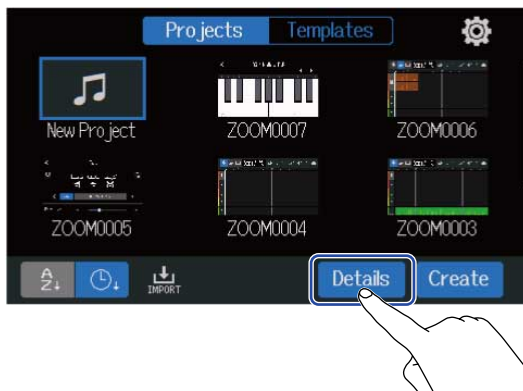

Tapping “Create” will create a project without changing settings.

### 4. Change the project settings by tapping and sliding.



#### 1 Project name editing

Tap this to open the Character Input Screen. See [Character Input Screen overview](#) for editing procedures.

#### 2 Tempo

This changes the setting of the tempo used for the entire song (40.0–250.0). (→ [Changing project tempos](#))

#### 3 Time Signature

This changes the setting of the time signature used for the entire song. (→ [Changing project time signatures](#))

#### 4 Bit Depth

This sets the amount of data per digital signal sample. The 24-bit option captures more information, increasing audio detail and expression, but it also creates more data.

#### NOTE:

Bit Depth cannot be changed later.

#### HINT:

By default, projects are automatically named “ZOOM0001” – “ZOOM9999”. Tap 1 to create a project with an edited name. That name will be saved and used when creating new projects, adding consecutive numbers in a “01” format automatically to the ends of their names.

Project names can be changed later. (→ [Changing project names](#))

## 5. Tap "Create".

This will create a new project with the changed settings, and open the Home Screen.



### NOTE:

The settings made on the Details Screen are saved. The same settings will be used when creating new projects.

Tapping "Create" on the Projects Screen without making settings on the Details Screen will create a new project using the Tempo, Time Signature and Bit Depth settings previously made on the screen.

# Opening a project

1. Tap "Projects" on the Projects Screen.

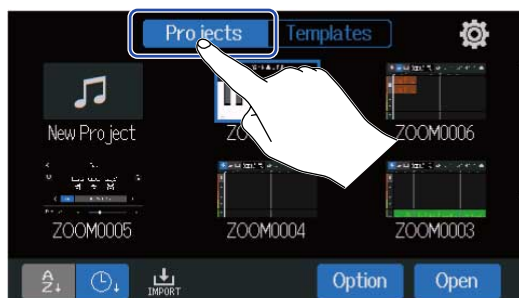

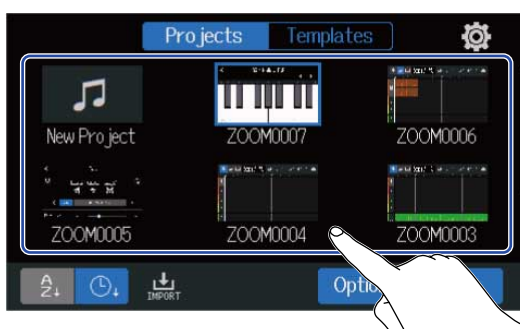

2. Tap the desired project to select it.



The selected project will be framed in blue.

## HINT:

Tap  (project name order) or  (date and time used order) to change the order shown.

3. Tap "Open".  
The project selected on the Home Screen will be shown.

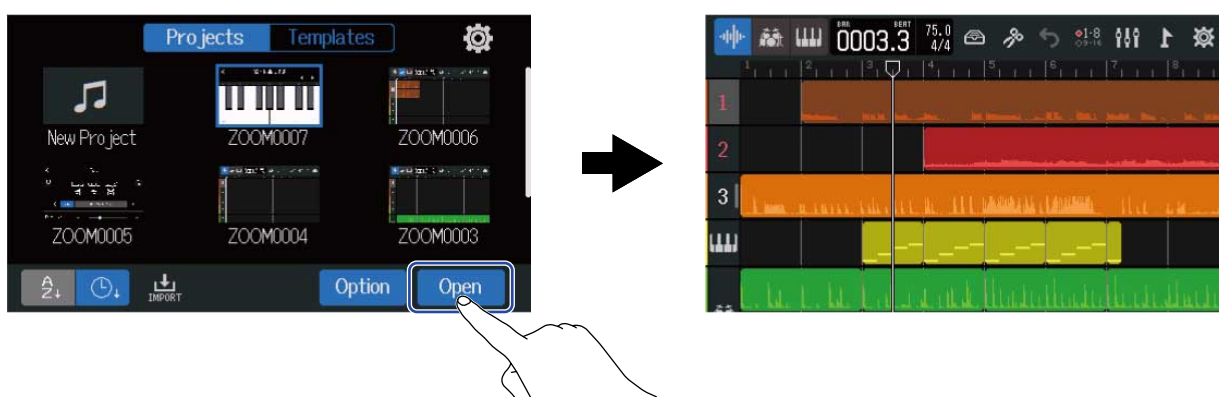

**NOTE:**

If the opened project file has a problem, the “Project Open Error!” message will appear. Follow these procedures to repair the project.

1. Tap “Execute”.

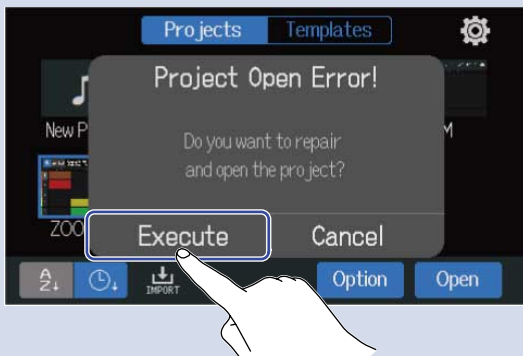

This will repair and open the project.  
Tap “Cancel” to cancel repair.

2. Tap “Close”.

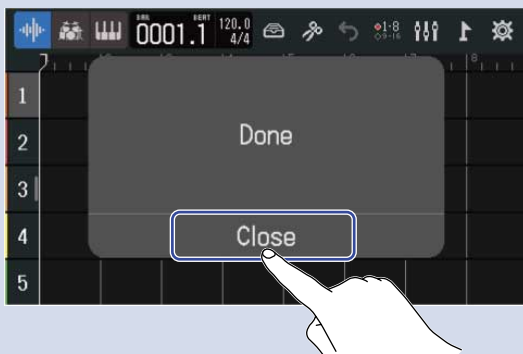

After repairing a project, a warning mark will be added to the original invalid project and a new repaired project will be created on the Projects Screen (→ [Opening projects](#)).

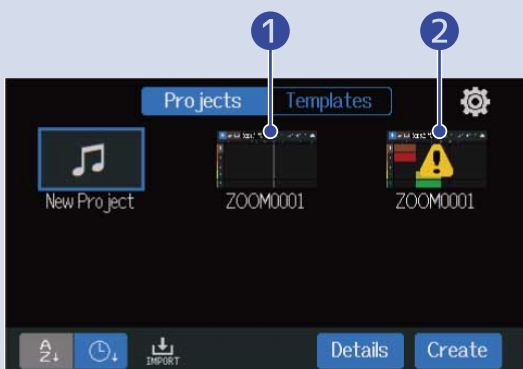

- 1 Repaired project
- 2 Original invalid project

The extension for the newly created project file will be “.zprj” and the extension for the original project file will become “.eproj”.

Depending on the state of the project data, it might not be repaired as intended.



# Changing project settings

Various project settings can be made on the Project Settings Screen. Settings are saved separately with each project.

Project settings can be made during playback. (→ [Playing projects](#))

## Opening the Project Settings Screen

1. Tap  on the Home Screen (Track View Screen/Level Meter View Screen).

Track View Screen



Level Meter View Screen

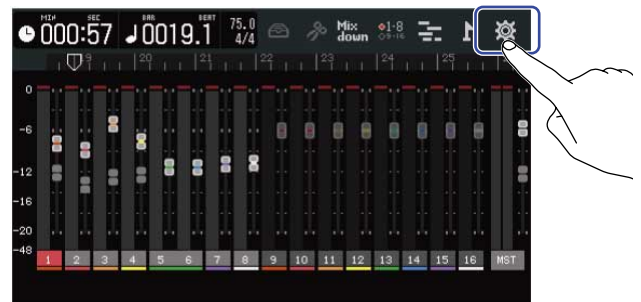



This opens the Project Settings Screen.

The name of the selected project can be checked on the Project Settings Screen.





# Changing project tempos

This changes the tempo used for the entire song.

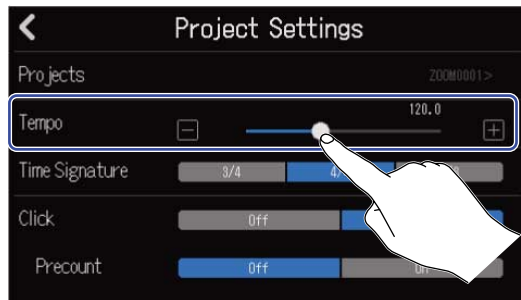
1. Slide the “Tempo” slider or tap  /  on the Project Settings Screen (→ [Opening the Project Settings Screen](#)).



## HINT:

- This can be set from 40.0–250.0.
- The tempo set here will be shared by the effects.
- When the Project Settings Screen is open, tapping  multiple times will also set the tempo. The tempo will be calculated from the intervals between  taps (tap tempo).



If the project Time Signature is set to 6/8, the tempo sets the length of dotted quarter notes. (→ [Changing project time signatures](#))

- Tapping the tempo/time signature in the Control Bar will also open the Tempo setting of the Project Settings Screen. (→ [Control Bar overview](#))



# Changing project time signatures

This changes the setting of the time signature used for the entire song.

1. Tap the desired “Time Signature” setting on the Project Settings Screen (→ [Opening the Project Settings Screen](#)).

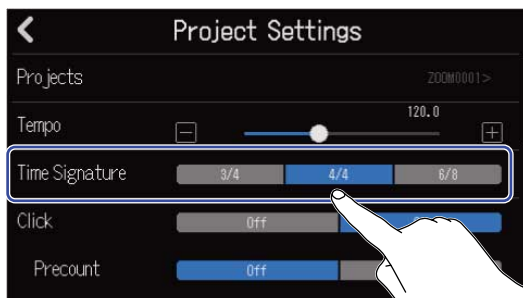

## HINT:

- The options are 4/4, 3/4 and 6/8.
- Tapping the tempo/time signature in the Control Bar will also open the Time Signature setting of the Project Settings Screen. (→ [Control Bar overview](#))



# Setting the metronome

The R20 has a metronome with a precount function.

This metronome, which can function during recording and playback, has switchable sounds and precount on and off settings.

Moreover, the metronome volume can be adjusted for different outputs, for example, to make the sound loud only in headphones.

## Using the metronome

Set whether the metronome is used during recording and playback.

1. Tap "On" or "Off" for "Click" on the Project Settings Screen (→ [Opening the Project Settings Screen](#)).

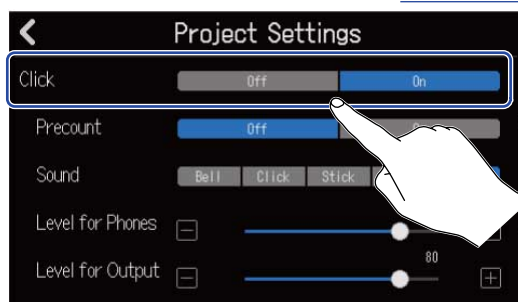

Setting	Explanation
Off	Do not use the metronome.
On	Use the metronome.

### HINT:

The metronome can also be switched on/off by pressing  on the Home Screen.

## Setting the precount

---

A metronome count can be sounded before starting recording.

1. Tap "On" or "Off" for "Precount" on the Project Settings Screen (→ [Opening the Project Settings Screen](#)).

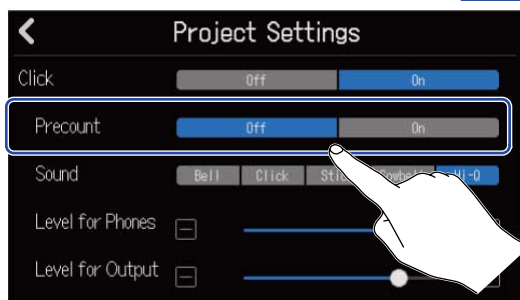

Setting	Explanation
Off	This turns off the precount.
On	This turns on the precount.

---

### HINT:

- The number of beats in the pre-count depends on the time signature setting (→ [Changing project time signatures](#)).
    - 4/4: 4
    - 3/4: 3
    - 6/8: 6
  - When the pre-count is playing, the region before the current stop position will also be played back.
-

## Changing the metronome sound

The metronome sound can be set to the preferred one.

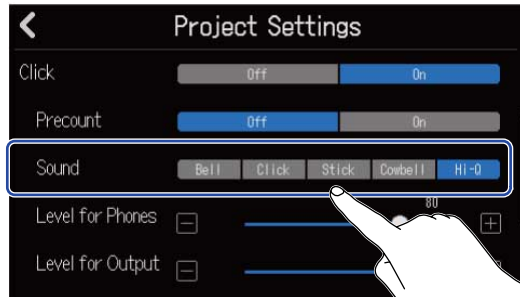

1. Tap the desired “Sound” setting on the Project Settings Screen (→ [Opening the Project Settings Screen](#)).



Setting	Explanation
Bell	Metronome sound (with bell on accents)
Click	Metronome sound (click only)
Stick	Drumsticks tapping sound
Cowbell	Cowbell sound
Hi-Q	Synthesized click sound

# Adjusting the metronome sound volume output from PHONES and OUTPUT jacks

---

1. Slide the “Level for Phones” and “Level for Output” sliders or tap  /  on the Project Settings Screen (→ [Opening the Project Settings Screen](#)).

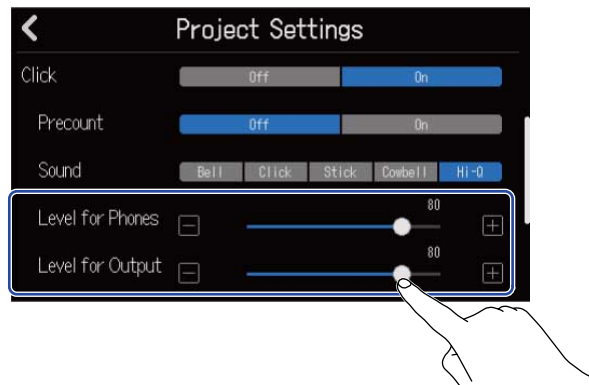

Setting	Explanation
Level for Phones	This adjusts the volume for the PHONES output jack.
Level for Output	This adjusts the volume for the OUTPUT jacks.

---

## HINT:

These can be set from 0 to 100.

---

# Changing the snap setting

The snap setting used for the entire project can be changed.

If this is “On”, notes and regions will be aligned to ruler increments when moved (→ [Control Bar overview](#)).

1. Tap “On” or “Off” for “Snap” on the Project Settings Screen (→ [Opening the Project Settings Screen](#)).

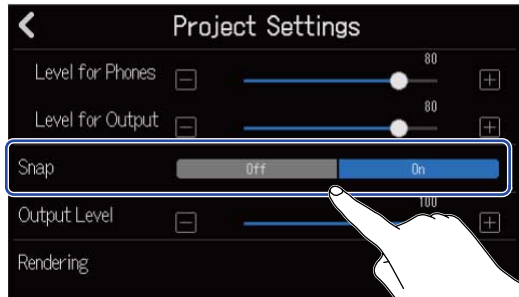

Setting	Explanation
Off	This turns off the snap function.
On	This turns on the snap function.

# Setting the project volume

Use this to adjust the project volume for output from the OUTPUT jacks.

1. Slide the “Output Level” slider or tap  /  on the Project Settings Screen (→ [Opening the Project Settings Screen](#)).

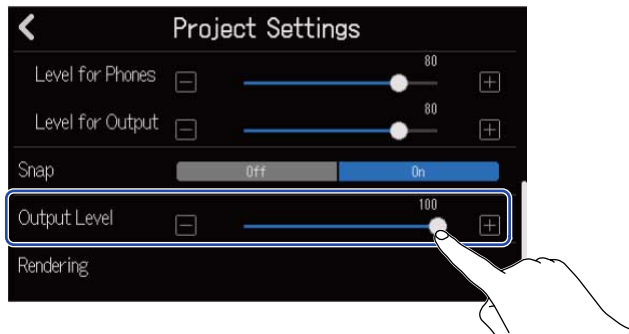

The set volume is shown above the slider.

**NOTE:**

This can be set from 0 to 100.



# Using the tuner

---

Using the tuner function, you can tune guitars and other instruments.

1. Tap “Tuner” on the Project Settings Screen (→ [Opening the Project Settings Screen](#)).

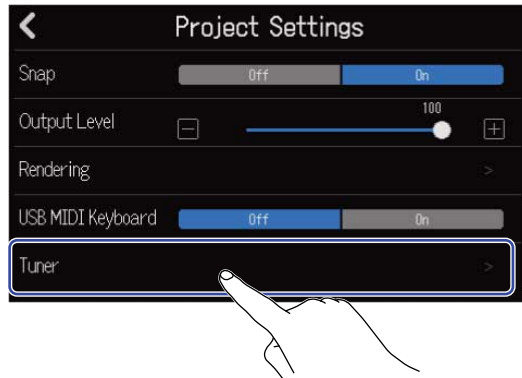

This opens the Tuner Screen.

2. Press  on the track that corresponds to the INPUT to which the guitar, bass or other instrument you want to tune is connected.
3. Play the open string that you want to tune and adjust its pitch.  
The pitch detuning with the nearest note name or string number will be shown.

Using the chromatic tuner

Using other tuners

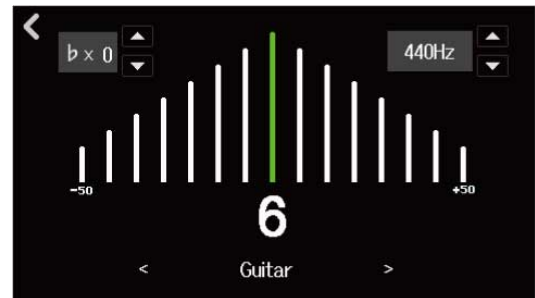
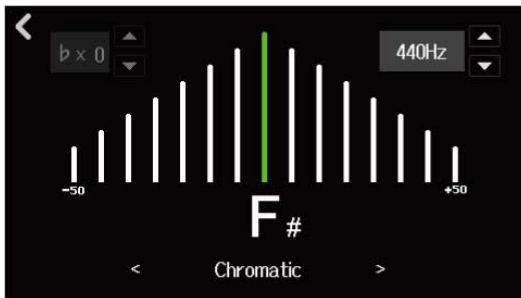



---

## HINT:

-  can also be tapped on the patch memory Edit Screen to open the Tuner Screen. (→ [Opening the patch memory Edit Screen](#))
  - On the Tuner Screen, the type can be selected (→ [Selecting the tuner type](#)), the standard pitch can be changed (→ [Setting the standard pitch of the tuner](#)) and flat tunings can be selected (→ [Using flat tunings](#)).
-

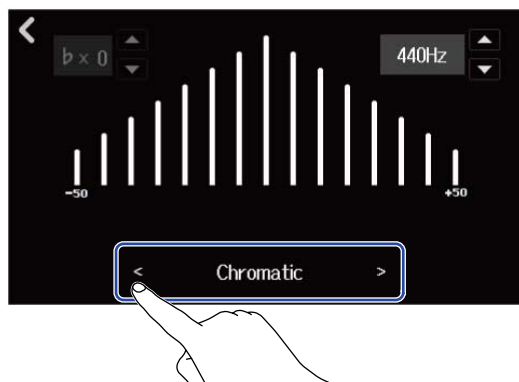

# Selecting the tuner type

1. Tap  or  on the Tuner Screen (→ [Using the tuner](#)).



Display	Explanation	String number/note						
		7	6	5	4	3	2	1
Chromatic	The name of the nearest note (in semitones) and the amount of detuning are shown.	-	-	-	-	-	-	-
Guitar	Standard guitar tuning with a 7th string	B	E	A	D	G	B	E
Bass	Standard bass guitar tuning with a 5th string	-	-	B	E	A	D	G
Open A	Open A tuning (open strings play A chord)	-	E	A	E	A	C#	E
Open D	Open D tuning (open strings play D chord)	-	D	A	D	F#	A	D
Open E	Open E tuning (open strings play E chord)	-	E	B	E	G#	B	E
Open G	Open G tuning (open strings play G chord)	-	D	G	D	G	B	D
DADGAD	Alternate tuning often used for tapping and other techniques	-	D	A	D	G	A	D

## Setting the standard pitch of the tuner

1. Tap  or  on the Tuner Screen (→ [Using the tuner](#)).

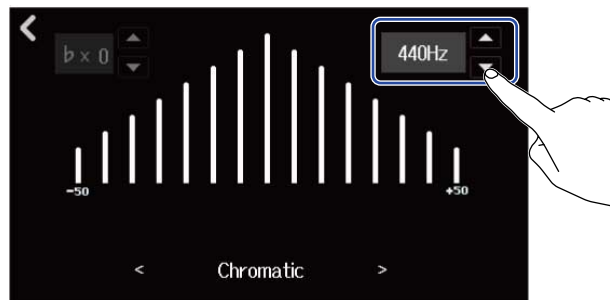



### NOTE:

This can be set from 435Hz to 445Hz.

## Using flat tunings

All strings can be tuned down from standard tuning by 1–3 semitones.

1. Tap  or  on the Tuner Screen (→ [Using the tuner](#)).

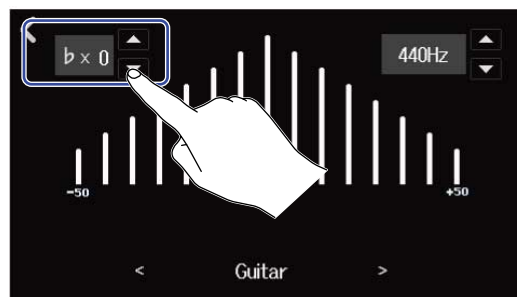

### NOTE:

- This can be set from  $\times 0$  to  $\times 3$  (3 semitones lower).
- Flat tuning cannot be used when the tuner type is CHROMATIC.

# Recording

---



## Recording process

---



### Preparation before recording

- Insert an SD card (→ [Inserting SD cards](#))
- Connect mics, instruments and other sources to inputs (→ [Connecting input devices](#))
- Turn the power on (→ [Turning the power on](#))
- Create a new project (→ [Creating new projects](#)) or open a project (→ [Opening a project](#))
- Make input settings (→ [Adjusting input levels](#), → [Making track settings](#))

### Recording

- Select tracks to record (→ [Enabling tracks for recording](#))
- Press  to start recording, and press  to stop it (→ [Recording](#))

### Playing back and reviewing

- Press  to start playback and  to stop it
- Mix down the tracks (→ [Mixing projects](#))

# Making input settings

## Connecting input devices

Connect the devices that you want to record. Mics, guitars, basses, synthesizers and other instruments can be connected.

### ■ Connecting mics

Connect dynamic mics to INPUT 1–8 and condenser mics to INPUT 5–8 using mic cables with XLR connectors.

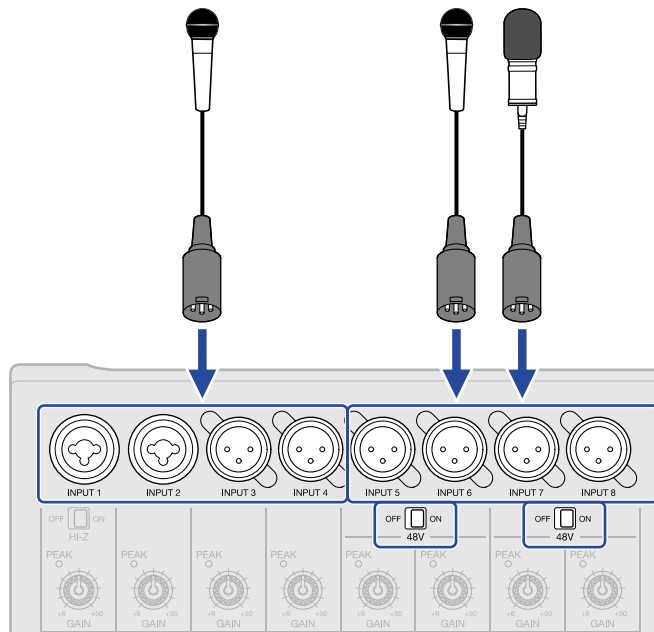

Inputs 5–8 support phantom power (+48V).

When connecting a condenser mic that requires phantom power, set  OFF  ON to ON.

#### NOTE:

When connecting devices that are not compatible with phantom power, do not set  OFF  ON to ON. Doing so could damage the device.

#### HINT:

Phantom power is a function that supplies power to devices that require an external power supply, including some condenser mics.

+48 V is common.

## ■ Connecting guitars and basses

Guitars, basses, synthesizers and other electronic instruments can be connected to INPUT 1 and 2 using cables with standard 1/4-inch plugs.

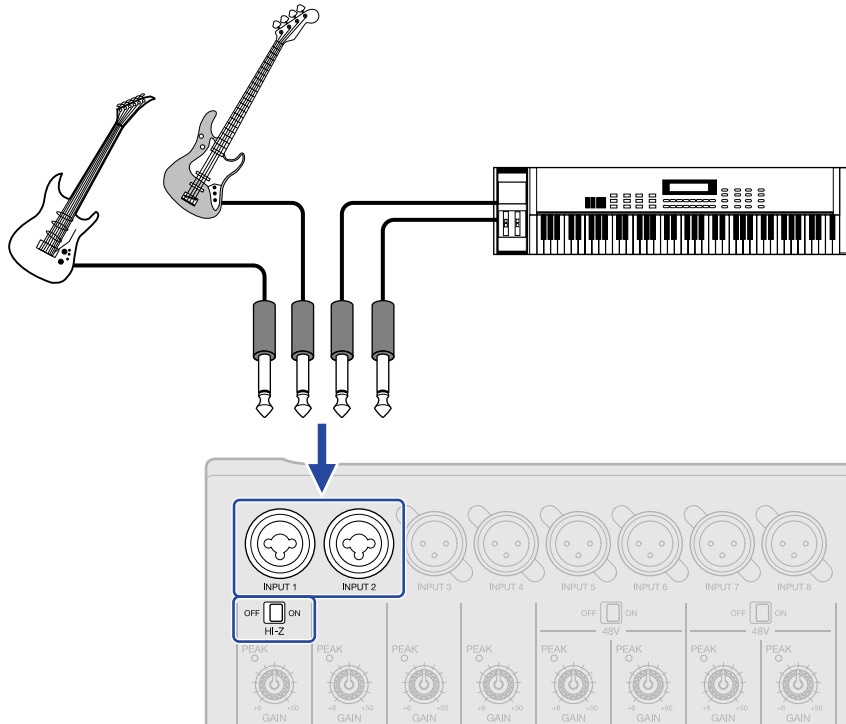

When directly connecting a guitar or bass with passive pickups, use INPUT 1 and set  OFF  ON to ON.  
Hi-Z

# Enabling tracks for recording

Tracks can be selected for recording.

- When an audio track is selected, the sound input through the corresponding INPUT jack will be recorded.
- When a synthesizer track is selected, MIDI data input using a MIDI keyboard, for example, will be recorded.

Track types can be checked on the [Track View Screen](#).

1. Press  for the tracks that you want to record.

Pressed  will light, and those tracks will enter recording standby.

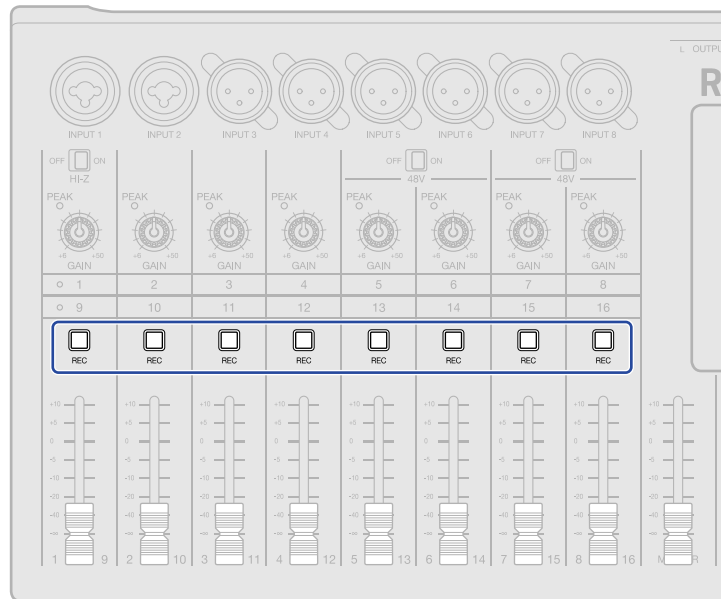

The track numbers on the Track View Screen and the track number backgrounds on the Level Meter View Screen will appear red.

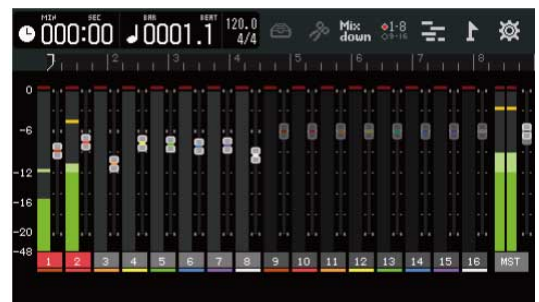







## NOTE:

- The input signals selected this way will also be sent to the MASTER tracks.
- By connecting a MIDI keyboard, for example, synthesizer track performances can be recorded. (→ [Using MIDI keyboards](#))
- Rhythm tracks cannot be armed for recording.

---

**HINT:**

- Track groups 1–8 and 9–16 can be switched and enabled for recording. Tap  or  to switch track groups. When , INPUT 1–8 inputs will be recorded to tracks 9–16. (Setting  for the switched tracks is necessary.)
  - Two adjacent tracks can be set to be a stereo track (→ [Enabling stereo linking](#)). In this case, pressing either  will cause the  for the other stereo-linked track to light simultaneously.
-



# Adjusting input levels

The levels of signals input to the R20 can be adjusted.

1. Turn  for the selected tracks to adjust their input levels.

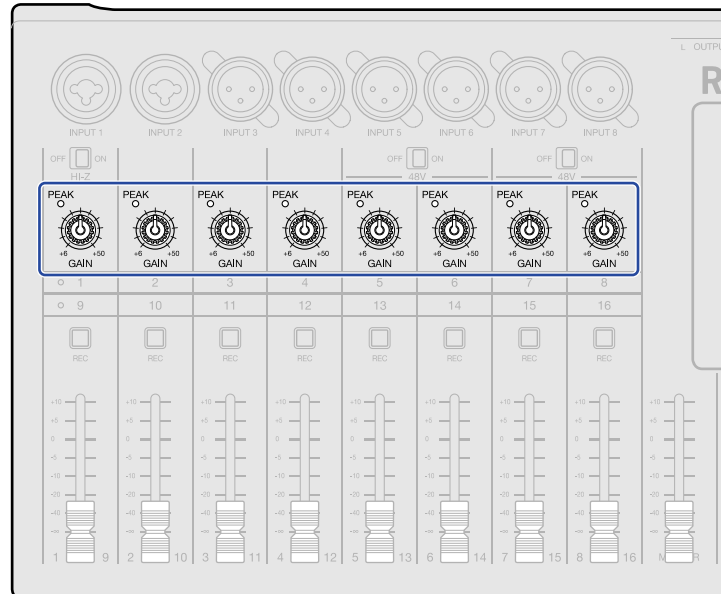

Adjust them so that their  indicators do not light.

## HINT:

- If the sound distorts even after lowering the input level, try changing mic positions and adjusting the output levels of connected devices.
- The Comp/Limiter/Gate function can also be used to adjust levels. (→ [Using the Comp/Limiter/Gate function](#))

# Making track settings

Settings can be made for tracks to be recorded.

Track types can be selected, EQ, dynamic, spatial and distortion effects can be adjusted, monitor panning can be set and send effects can be adjusted.



In addition, two adjacent tracks can be stereo-linked and used as a stereo track.

## Setting track types

Track types can be set to audio, rhythm or synthesizer.



1. Tap the header for the track you want to set the type for.



2. Tap ,  or  in the Control Bar.



When set as a rhythm or synthesizer track, the track number will be replaced with a rhythm or synthesizer track icon.

Setting	Explanation
 Audio track	Sound input through an INPUT jack is recorded and played back. WAV files can also be imported from SD cards and USB flash drives and placed as regions.
 Rhythm track	Rhythm loops included in the R20 can be placed and played back. (→ <a href="#">Using internal rhythm loops</a> )
 Synth track	MIDI data can be input and MIDI files from SD cards and USB flash drives can be placed as regions and used with the synthesizer sound source in the R20. MIDI data performed on a MIDI keyboard can be recorded and played back. (→ <a href="#">Using the synthesizer</a> )

**NOTE:**

Each project can only have one set synthesizer track. If a synthesizer track already exists and has a region, a new synthesizer track cannot be set.

# Opening Track Settings Screens

On Track Settings Screens, EQ, dynamic (Comp/Limiter/Gate) effects and send effects can be adjusted, and monitor panning and stereo links can be set.

1. Double-tap the header for the track that you want to set.



2. Tap "Track Settings".

This opens the Track Settings Screen.



## HINT:

- Tap ◀▶ at the top of the screen to open the screen for an adjacent track.

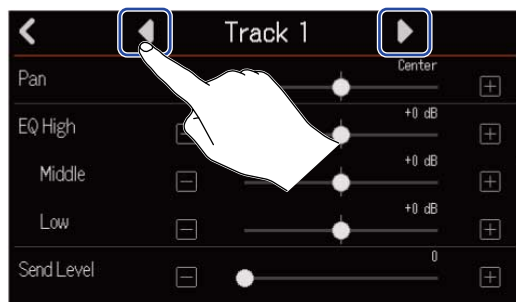

- Stereo-linked tracks are shown with track names like "Track 1/2".

# Adjusting monitor panning

The left-right panning of each track can be adjusted when monitoring input signals through headphones or powered monitors.

1. On a Track Settings Screen (→ [Opening Track Settings Screens](#)), slide the Pan slider or tap  / .

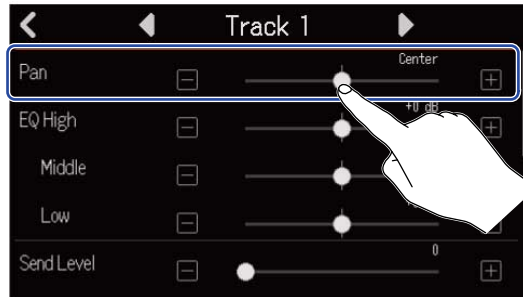

## NOTE:

- The setting range is L100 (left) – Center – R100 (right).
- This panning adjustment only affects the monitoring signal. It has no effect on individual track recording data.
- These settings are saved separately for each recorded project. This can also be changed during playback.

# Adjusting EQ

The amount of boost/cut of each frequency band can be adjusted.

1. On a Track Settings Screen (→ [Opening Track Settings Screens](#)), slide the EQ Low, Middle and High sliders or tap  / .

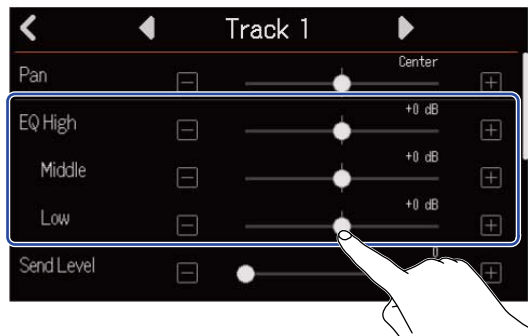

## ■ High

This adjusts the boost/cut of high-frequency equalization.

- Type: shelving
- Gain range: -12 dB - +12 dB
- Frequency: 10 kHz

## ■ Middle

This adjusts the boost/cut of mid-frequency equalization.

- Type: peaking
- Gain range: -12 dB - +12 dB
- Frequency: 2.5 kHz

## ■ Low

This adjusts the boost/cut of low-frequency equalization.

- Type: shelving
- Gain range: -12 dB - +12 dB
- Frequency: 100 Hz

# Enabling stereo linking

Two adjacent tracks (1 and 2 or 3 and 4, for example) can be set as a stereo track. This enables those inputs to be handled as a stereo sound. This will record the tracks as stereo data, which is convenient when editing, for example. (Stereo Link function)

1. On a Track Settings Screen (→ [Opening Track Settings Screens](#)), tap “On” or “Off” for Stereo Link.



## NOTE:

- If a track already has regions, stereo-linking will not be possible.
- Only audio tracks can be stereo-linked.

## HINT:

While pressing one of two adjacent  buttons, pressing the other one (1 and 2, 3 and 4, for example) will stereo link those tracks. Do the same thing to end a stereo link.

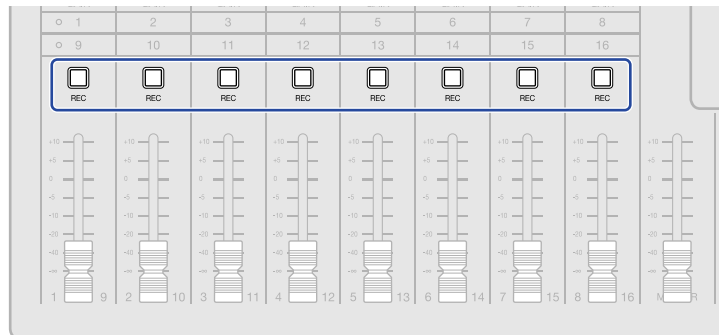

## Using the Comp/Limiter/Gate function

The volume can be adjusted suitably according to input signal levels and unwanted noise can be cut, making the sound clearer.

- **Comp**  
The compressor reduces level differences between loud and quiet sounds, making the sound clearer.
- **Limiter**  
The limiter can prevent distortion by reducing input signals that have high levels.
- **Gate**  
This cuts input signals with low levels, reducing background noise.

The compressor and limiter lower input signals with high levels according to the parameter adjustments shown below. The limiter has a stronger effect compared to the compressor. The gate cuts input signals with low levels according to the parameter adjustments shown below.

Comp/Limiter

Gate

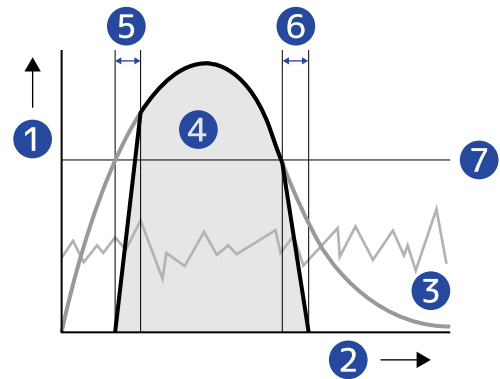
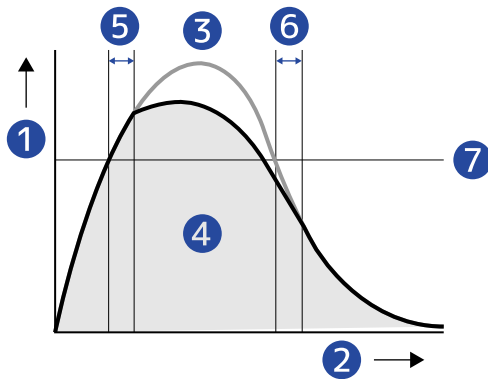

- 1 Level
- 2 Time
- 3 Original signal
- 4 Output signal when Comp/Limiter/Gate used
- 5 Attack Time
- 6 Release Time
- 7 Threshold



Parameter	Explanation
Threshold	Comp/Limiter: This adjusts the input level that activates the effect. When the input level exceeds the threshold, the excess level is compressed with a ratio of 1:4 for Comp and 1:20 for Limiter. Gate: This adjusts the input level that deactivates the effect. Sound below the threshold level will not be output.
Attack Time	Comp/Limiter: This adjusts the speed that the effect is activated after the input signal exceeds the threshold level. Gate: This adjusts the speed that the effect is deactivated after the input signal exceeds the threshold level.
Release Time	Comp/Limiter: This adjusts how quickly the effect is deactivated after the input signal goes below the threshold level. Gate: This adjusts the speed that the effect is activated after the input signal goes below the threshold level.

**NOTE:**

Comp/Limiter/Gate settings can be changed during recording and playback.

1. Tap the desired "Input Dynamics" setting on the Track Settings Screen (→ [Opening Track Settings Screens](#)).



Setting	Explanation
Off	This turns the Comp/Limiter/Gate off. No settings can be made from step 2.
Compressor	This selects the compressor. The ratio is 4:1.
Limiter	This will apply the limiter. The ratio is 20:1.
Noise Gate	This will apply the noise gate.

**NOTE:**

Comp/Limiter/Gate cannot be used simultaneously on both tracks that share the same input. For example, if it is used on track 1, it cannot be used on track 9.

2. Slide the Threshold slider or tap  and  to adjust the threshold level.



**HINT:**

This can be set from -16 to -2 dBFS for the compressor and limiter.  
This can be set from -80 to -2 dBFS for the noise gate.

3. Slide the Attack Time slider or tap  and  to adjust the attack time.



**HINT:**

This can be set from 1 to 4 ms.

4. Slide the Release Time slider or tap  and  to adjust the release time.

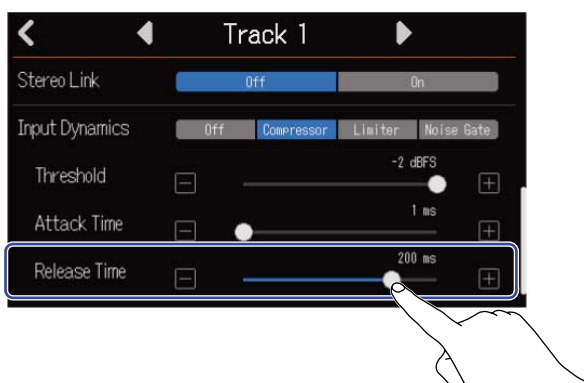

**HINT:**

This can be set from 1 to 500 ms.

# Using effects

The R20 has effects that are equivalent to those in ZOOM multi-effects processors. Patch memories that contain up to three effects can be selected. By selecting patch memories, a variety of effects can be applied to instruments, voices and other sound sources.

Using the free Guitar Lab effect management application on a computer (Mac/Windows), you can add effects that are distributed online as well as edit and back up patch memories, for example.

Effects can be used in the following two ways.

- **Send effect**

The input or playback sounds from individual tracks are sent to this effect. The sound with the effect applied is output through the PHONES and OUTPUT jacks, so it can be checked through headphones or powered monitors. The amount the effect is applied can be adjusted by setting the level sent to the effect (send level).

The send effect does not affect recording data, but it does affect mixdown data.

This effect can be applied to multiple tracks, allowing it to be used, for example, to add reverb to every track.

- **Insert (input) effect**

This effect is applied directly to the track, so it does affect recording data.

Use this to record a guitar with distortion, for example.

The insert (input) effect can only be used on one track.

**NOTE:**

Only one send or one insert (input) effect can be used at a time. The send and insert (input) effect functions cannot be used at the same time.

## Using send effects

The send levels for signals sent to the effect can be adjusted for all tracks. The higher the send level the greater the effect.

1. Tap "Send Effect" on a Track Settings Screen (→ [Opening Track Settings Screens](#)).

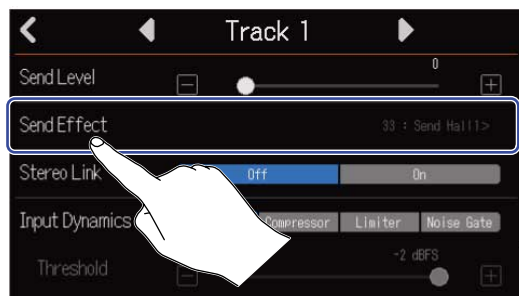

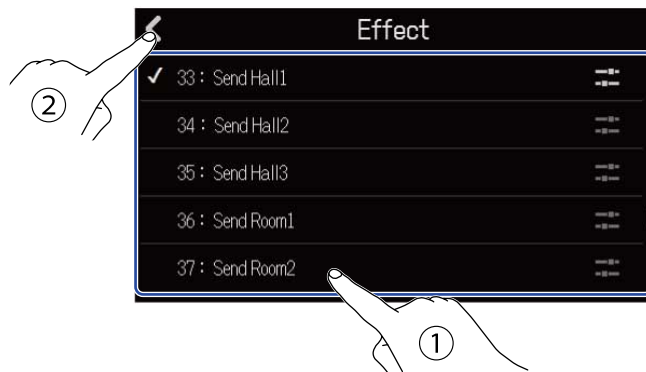

2. On the Effect Screen, select a patch memory (①), and tap  (②).



This reopens the Track Settings Screen.

**HINT:**

See [Editing patch memories](#) for details about how to edit patch memories.

3. Slide the Send Level slider or tap  and  .

This adjusts the send level.

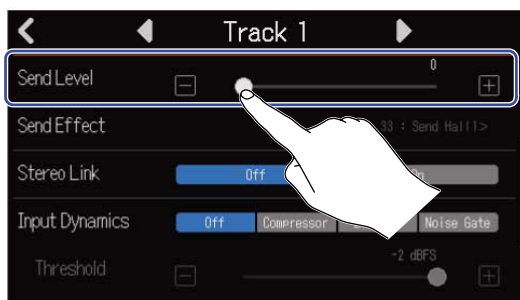

**NOTE:**

To record the affected sound, use an insert (input) effect.

# Using insert (input) effects

1. Tap a Track Header on the [Track View Screen](#) and select an audio track to assign the insert (input) effect to it.



**NOTE:**

Effects can only be used on audio tracks.

2. Tap  in the Control Bar.



3. On the Effect Screen, select a patch memory (①), and tap  (②).

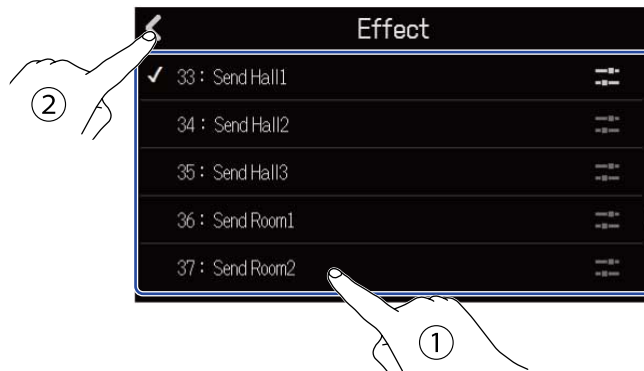

The Track View Screen will reopen.

**HINT:**

See [Editing patch memories](#) for details about how to edit patch memories.

# Editing patch memories





## Opening the patch memory Edit Screen

1. On the Effect Screen, tap  for the patch memory you want to edit.

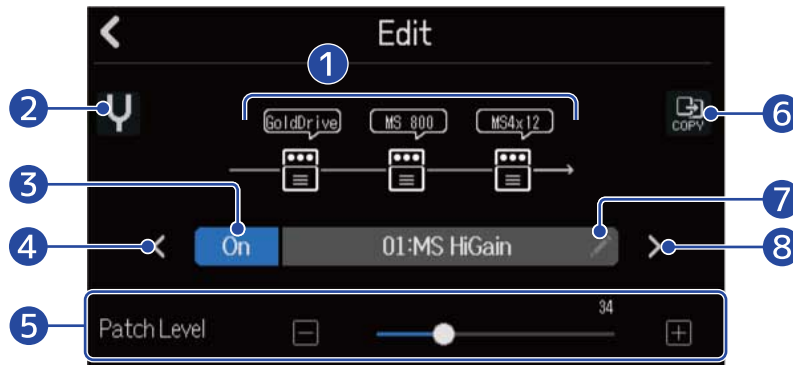

This opens the patch memory Edit Screen.



- 1 **Effects used**  
Tap these to adjust the parameters of the effects. (→ [Adjusting effect parameters](#))
- 2 **Tuner button**  
Tap this to use the tuner. (→ [Using the tuner](#))
- 3 **Patch memory On/Off button**  
Tap this to turn the patch memory on/off.
  - On: 
  - Off: 
- 4 **Select previous patch memory**
- 5 **Adjust patch memory volume**  
Slide the slider or tap  and  to adjust the patch memory volume.
- 6 **Copy button**  
Use this to copy the settings of the current patch memory to another one. (→ [Copying patch memories](#))

**7** Patch memory name edit button

Tap this to open the Character Input Screen. See [Character Input Screen overview](#) for editing procedures.

**8** Select next patch memory

**HINT:**

The content of edited patch memories will be saved automatically.

## Turning patch memories on/off

- 1.** Tap "On" or "Off" on the patch memory Edit Screen (→ [Opening the patch memory Edit Screen](#)).

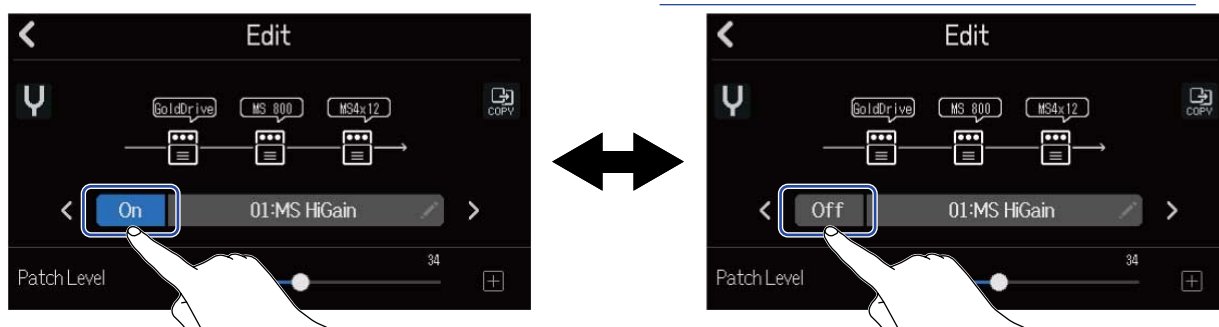

## Adjusting effect parameters

1. Tap the effect you want to edit on the patch memory Edit Screen (→ [Opening the patch memory Edit Screen](#)).

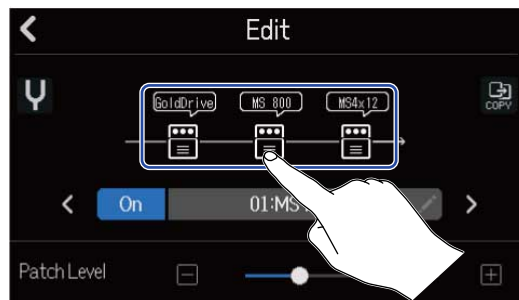

This opens the Effect Settings Screen.

2. Adjust the effect.



- 1 Return to the patch memory Edit Screen
- 2 Replace effect  
Tap this to open the Effect List Screen. Tap the desired effect to select it.
- 3 Turn effect on/off  
Tap this to turn the effect on/off.
- 4 Effect adjustment parameters  
Slide the patch memory sliders or tap **-** and **+** to adjust the parameters.

### NOTE:

- Three effects can be combined as desired in a patch memory. If the processing capability limit is exceeded, however, a “Process Overflow” warning will appear and effects will be bypassed. Change one of the effects to end this condition.
- The parameters that can be adjusted depend on the effect.



## Copying patch memories

Patch memory changes are saved automatically. To save the original patch before changing it, copy it to an empty patch memory.

1. Tap  on the patch memory Edit Screen (→ [Opening the patch memory Edit Screen](#)).

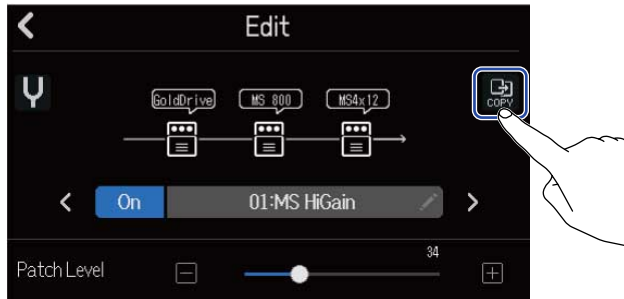

This opens a patch memory list.

2. Tap the name of the copy destination patch memory.

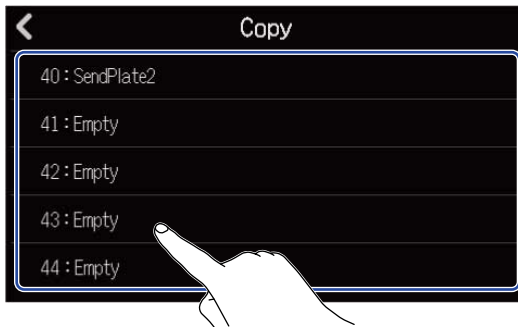

3. Tap "Execute".

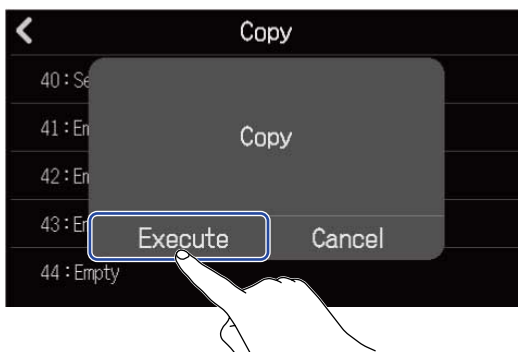

**NOTE:**

Patch memories are not saved in projects. 50 patch memories can be saved as R20 settings.

## Changing patch memory names

---

1. Tap  on the patch memory Edit Screen (→ [Opening the patch memory Edit Screen](#)).

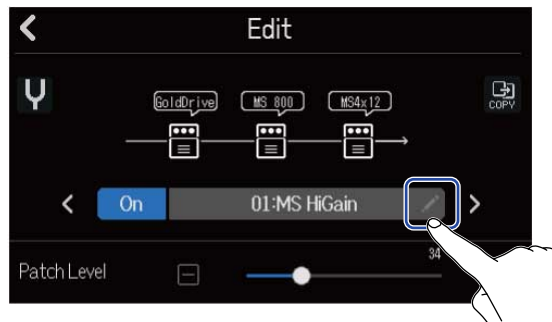

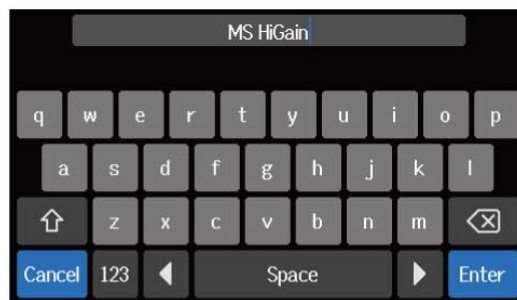

This opens the Character Input Screen.

2. Input the patch memory name.  
See [Character Input Screen overview](#) for how to input characters.



3. When "Done" appears, tap "Close".  
This changes the patch memory name and returns to the previous screen.

## Changing patch memory levels

1. On the patch memory Edit Screen (→ [Opening the patch memory Edit Screen](#)), slide the “Patch Level” slider or tap  and .

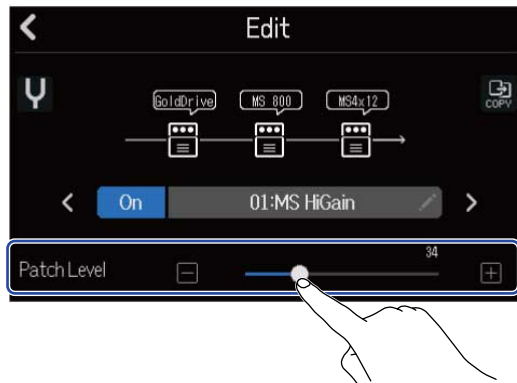

**NOTE:**

This can be set from 0 to 120.

# Recording

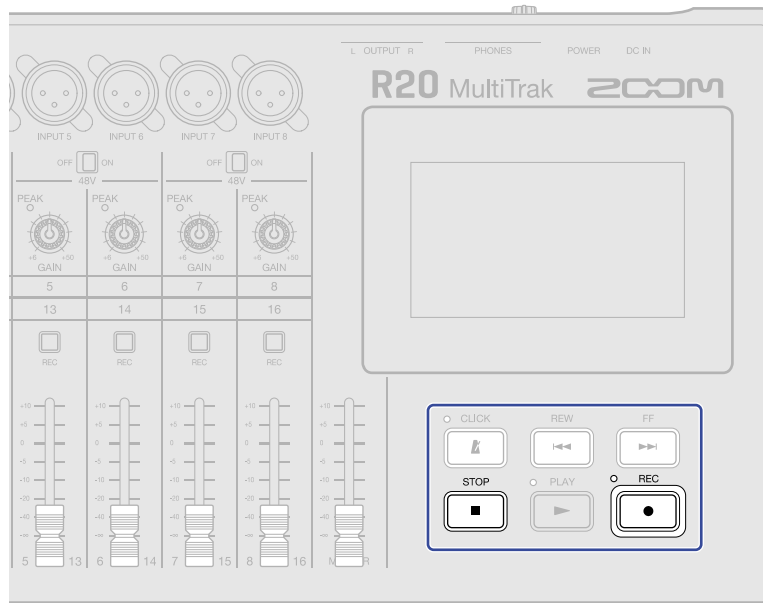

1. Press  when the Track View Screen or Level Meter View Screen is open.

This starts recording from the current playback position. The  indicator lights during recording.

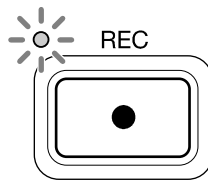

Pressing  when a screen other than the Track View Screen or Level Meter View Screen is open will open one of those screens.







2. Press  to stop.

## NOTE:

- A project can have a maximum of 1350 bars. Recording will stop automatically if it reaches this length.
- Recording is not possible if the SD card does not have open space.

---

**HINT:**

- Pressing  during playback will start recording from that point.
  - See [Using the synthesizer](#) for information about recording synth tracks.
  - Even when recording, the Screen Switching buttons (  ) can be tapped to switch to the [Track View Screen](#) and [Level Meter View Screen](#). (→ [Control Bar overview](#))
  - Press  +  to move to the next marker or  +  to move to the previous marker. (→ [Using markers](#))
  - If Undo is used with recording, the playback position will return to the recording start position. If redo is used, the playback position will return to the recording end position. (→ [Control Bar overview](#))
-

# Using internal rhythm loops

The R20 includes rhythm loops for various genres.

By setting the track type to rhythm, drum patterns and other rhythm loops can be assigned to it as desired and played back.

1. Tap the track on which you want to place a rhythm loop on the [Track View Screen](#). This highlights the tapped track.



2. Tap .

This changes the track tapped in step 1 to a rhythm track.





## NOTE:

- Rhythm tracks are stereo tracks.

3. Tap  in the Control Bar.



This opens the Rhythm Loops List.

4. Tap  to preview rhythm loops.  
The selected rhythm loop will play back.  
Tap  again to stop playback.

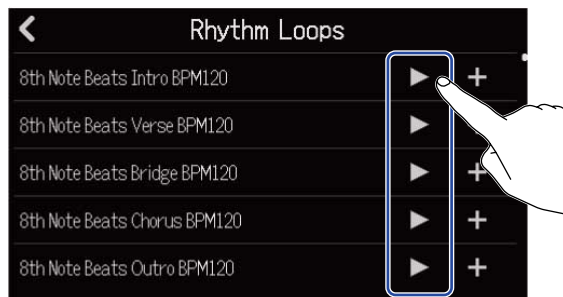

5. Tap  for the rhythm loop you want to add.  
The selected rhythm will be added to the rhythm track.

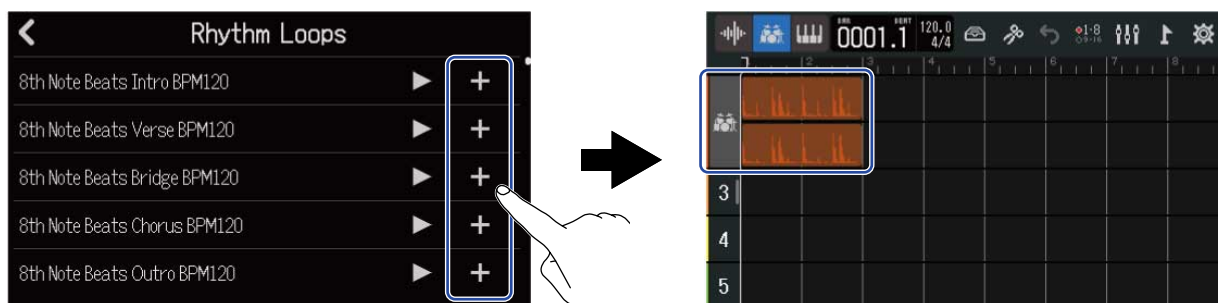

**NOTE:**

- The rhythm loop will be added to the selected track from the playback header.
- Rhythm loops are automatically synchronized with the set tempo of the project when added. (→ [Changing project tempos](#))

## ■ Rhythm loops

The R20 has Intro, Verse, Bridge, Chorus and Outro sections for the following rhythm loops.

Genre	BPM	Genre	BPM
8th Note Beats	120	Bounce Pop	85
16th Note Beats	108	Modern R&B	75
4th Note Beats	168	Neo Soul	90
Pop Rock	136	Modern 80's	100
Retro Rock	110	80's Pop	118
Hard Rock	80	Synthpop	120
Punk Rock	130	Big Room House	128
Funk Rock	95	Tech House	125
Britpop	80	Dubstep	140
Indie Pop	100	Electro Trap	70
Indie Disco	120	Trap	70
Indie Rock	100	Boom Bap	85
Garage Rock	150	Latin Percussion	95
Funky Soul	90	Pop Percussion	110
16feel Pop	90	Street Live Percussion	90



# Using the synthesizer

The R20 includes various synthesizer sound types.

By connecting a USB MIDI keyboard (sold separately) to the R20, the keyboard can be played to record the selected synthesizer sound.

## Selecting the synth sound

1. On the [Track View Screen](#), tap the track you want to record the synth on.  
This highlights the tapped track.



2. Tap .

This makes the track tapped in step 1 into the synth track.



3. Tap .



This opens the Synth List.

4. Tap  to check the sound of a synth.

This will open a keyboard. Tap the keys to play the sound.

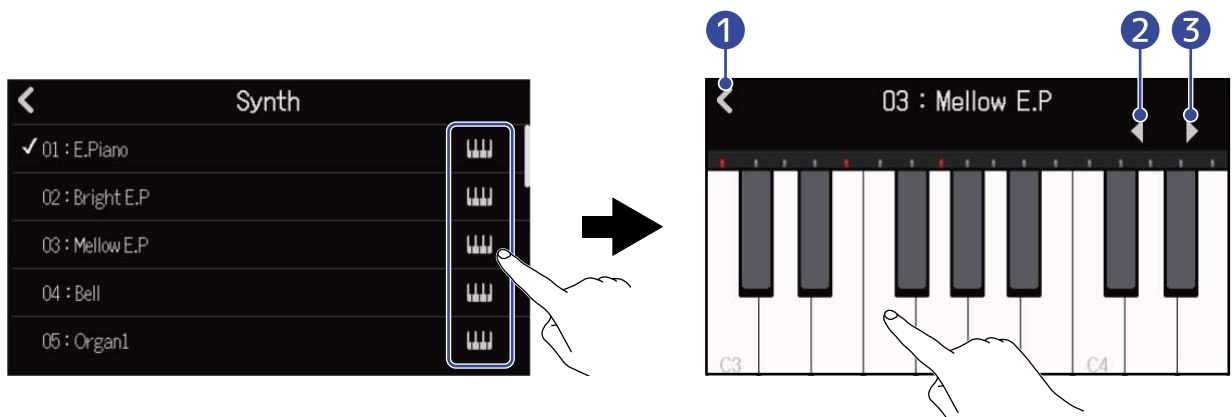

- 1 Return to the previous screen.
- 2 Lower the octave.
- 3 Raise the octave.

**HINT:**

- Note names are shown on every C of the keyboard (every octave).
- Up to 8 notes can be output at a time (8-voice polyphony).
- The range is C0–E8.
- When notes are output, the red indicators above the keyboard light.

5. Tap a synth name to select it.

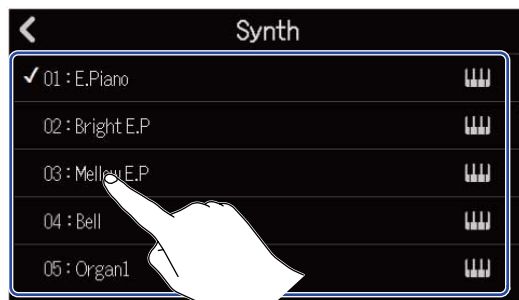



The tapped synth will be selected.

The R20 has the following synth sounds.

E.Piano	Organ2	Slap Bass	Brass2
Bright E.P	Pipe Organ	AcousticBass	Brass3
Mellow E.P	Finger Bass1	Synth Bass1	Synth Lead
Bell	Finger Bass2	Synth Bass2	Drum Kit
Organ1	Pick Bass	Brass1	

# Recording

1. Referring to [Using MIDI keyboards](#), connect a midi keyboard to the R20.
2. Press  for the synth track so that it lights red.
3. Press .  
Recording will start from the current playback position.
4. Play the MIDI keyboard.  
The MIDI keyboard performance will be recorded as MIDI data on the synth track.
5. Press  to stop.

---

**HINT:**

Notes can also be input using the touchscreen instead of using a MIDI keyboard. (→ [Editing notes \(synth regions\)](#))





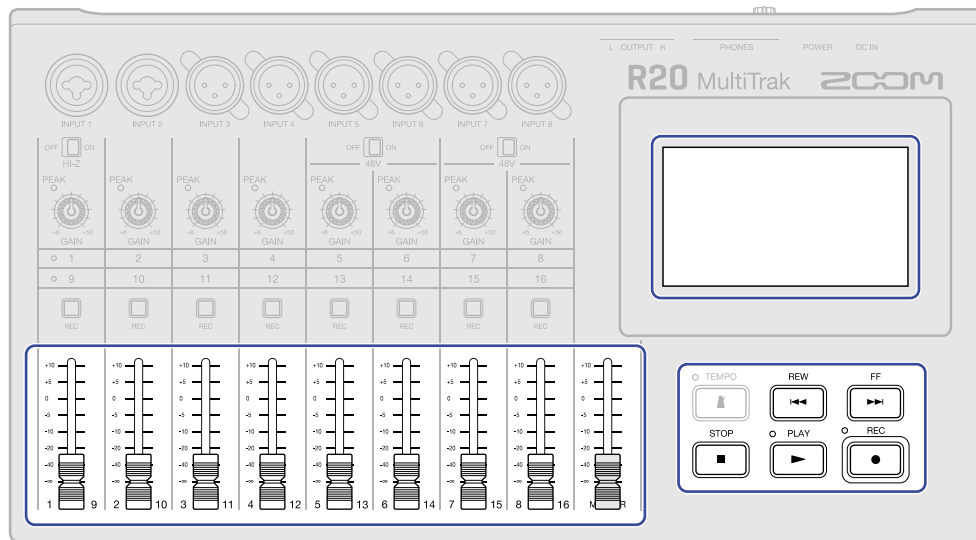





---

# Playing projects



1. Press .

## Button operations during playback

- Search backward/forward: Press and hold  / 
- Move playback position forward/backward: Press  / 
- Stop: Press  or .
- Return to beginning: Press  when stopped
- Adjust track volume: Move channel fader
- Adjust master track volume: Move MASTER channel fader
- Move to previous/next marker: Press  +  /  + 

## Touchscreen operations during playback

- Zoom in/out horizontally:

Pinch in horizontally: Shorten the timeline display

(This enables showing many bars at the same time.)

Pinch out horizontally: Lengthen the timeline display

(This enables displaying more detail.)



- Move playback position: Slide playback header left/right or tap the ruler





## ■ Moving multiple regions simultaneously

1. On the [Track View Screen](#), double-tap a region that you want to move.



This highlights that region and opens the Option Menu at the top of the screen.

2. Tap "Select".

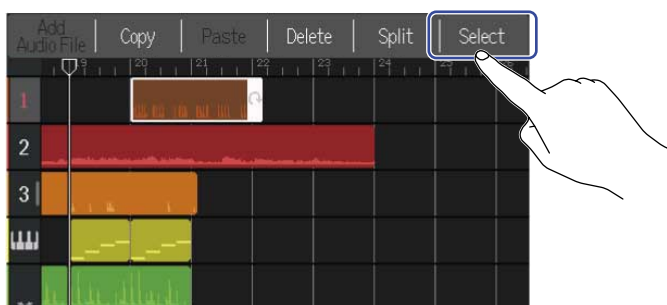

3. Tap the other regions that you want to move.  
The selected regions will be highlighted.

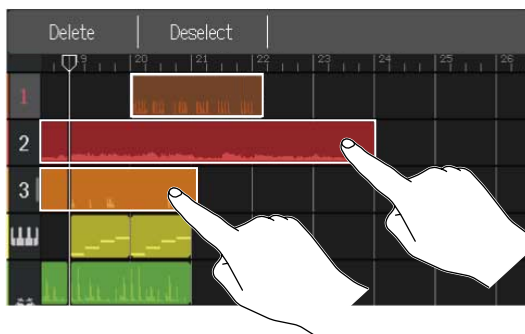

Tapping a selected region will deselect it.

4. Drag the selected regions to the desired position.



Tap "Deselect" to return to the previous screen.

# Looping regions

Regions can be looped (played back repeatedly).

1. On the [Track View Screen](#), tap the region you want to loop. This highlights the selected region.



2. Drag the right edge of the region.



Dragging right will increase the number of loops, while dragging left will decrease the number.



## Creating empty synth track regions (synth track only)

Regions can be created for adding MIDI notes manually. (→ [Editing notes \(synth regions\)](#))

1. On the [Track View Screen](#), double-tap an area with no region on the synth track.

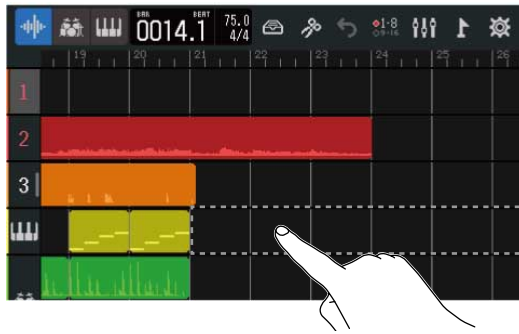

The Option Menu will open at the top of the screen.

2. Tap "Create Region".

An empty synthesizer region that is one bar long will be created at the double-tapped position.



# Loading WAV files as regions

WAV files on SD cards and USB flash drives can be loaded into projects.

**NOTE:**

Files with the following formats can be loaded.

- WAV files: Either 44.1kHz/16-bit or 44.1kHz/24-bit according to the project setting

1. Copy the files that you want to load onto the SD card or USB flash drive in advance.
  - When loading from an SD card: Put the files in the “AUDIO” folder on the SD card. (→ [SD card folder and file structure](#))
  - When loading from a USB flash drive: Put the files in the “ZOOM\_R20” > “AUDIO” folder on the USB flash drive. (→ [USB flash drive folder and file structure](#))

2. On the [Track View Screen](#), move the playback header to the position where you want to load the file.



3. Double-tap part of an audio track that has no regions.

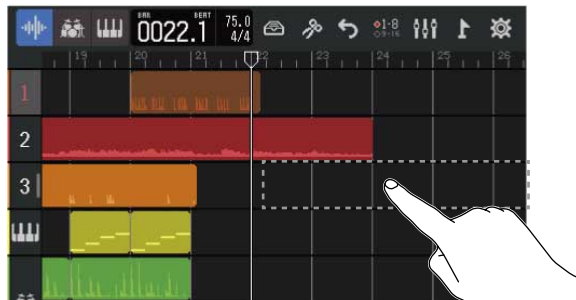

The Option Menu will open at the top of the screen.

4. Tap "Add Audio File".



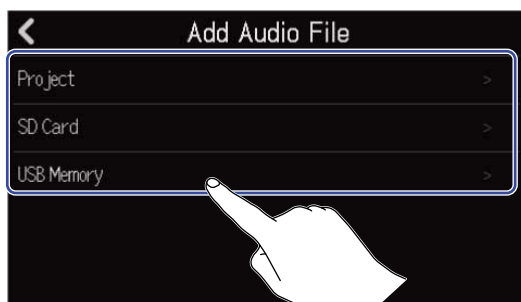

5. Tap "Project" to load from a project, "SD Card" to load from an SD card, or "USB Memory" to load from a USB flash drive.



**HINT:**

When loading from a USB flash drive, connect it to the USB port. (→ [Connecting USB flash drives](#))

6. Tap  to preview the file you want to load.

This will play the selected file.  will light ().

Tap  to stop playback.

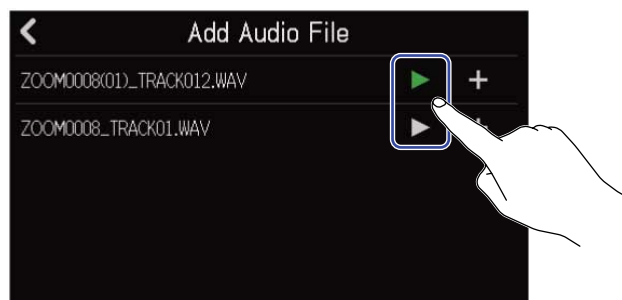

7. Tap **+** for the file you want to load.

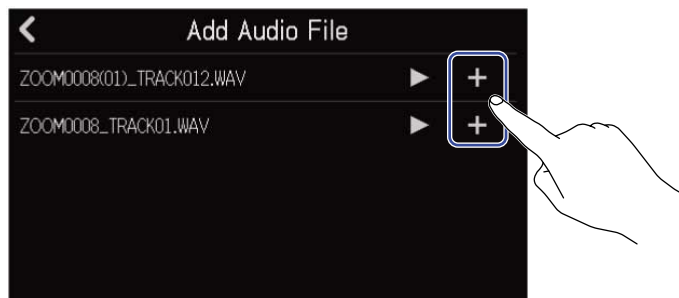

**NOTE:**

- An error message will appear if it cannot be loaded. Select a different file.
- Loading is not possible if the maximum number of regions in the project would be exceeded.
  - Total number of audio and rhythm regions: 50
  - Synth regions: 80

8. Input the file name of the loaded WAV file.



See [Character Input Screen overview](#) for how to input characters.

9. When "Done" appears, tap "Close".

This completes loading the track and opens the Track View Screen.

# Loading MIDI files as regions

MIDI files on SD cards and USB flash drives can be loaded into projects.

**NOTE:**

MIDI files with the following formats can be loaded.

- SMF (Standard MIDI File): Format 0/Format 1

1. Copy the files that you want to load onto the SD card or USB flash drive in advance.
  - When loading from an SD card: Put the files in the “MIDI” folder on the SD card. (→ [SD card folder and file structure](#))
  - When loading from a USB flash drive: Put the files in the “ZOOM\_R20” > “MIDI” folder on the USB flash drive. (→ [USB flash drive folder and file structure](#))
2. On the [Track View Screen](#), move the playback header to the position where you want to load the file.



3. Double-tap part of a synth track that has no regions.

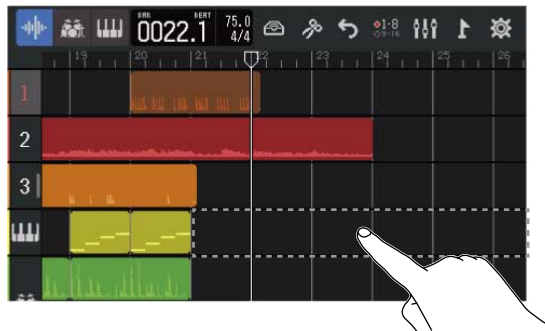

The Option Menu will open at the top of the screen.

4. Tap “Add MIDI File”.

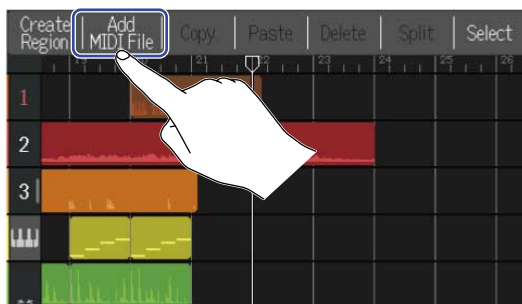

5. Tap the channel in the MIDI file that you want to load.

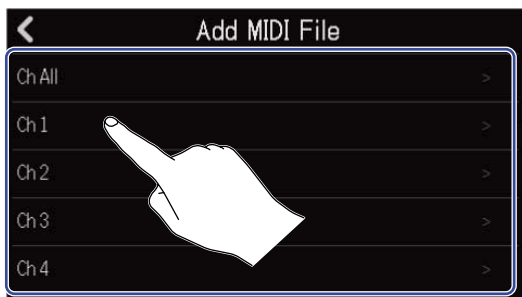

**NOTE:**

- This loads the notes in the selected channel.
- When loading a MIDI file that has multiple channels, selecting “Ch All” will create a region with the notes from those channels on the R20 synth track. In this case, the timbre of each channel will be automatically assigned from their program change numbers.
- The notes in the synth regions that have been loaded using “Ch All” cannot be edited.
- “Ch All” cannot be selected if the synth track already has regions. Moreover, other regions cannot be added if there is a MIDI file that was loaded using “Ch All”.

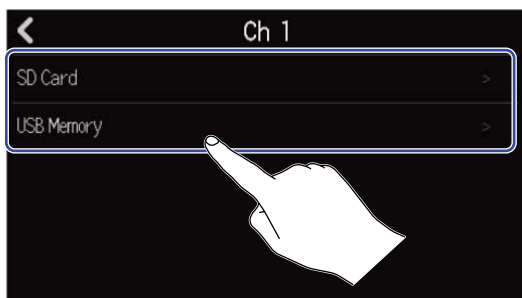

6. Tap “SD Card” to load from an SD card, or tap “USB Memory” to load from a USB flash drive.



**HINT:**

When loading from a USB flash drive, connect it to the USB port. (→ [Connecting USB flash drives](#))

7. Tap  to preview the file you want to load.

This will play the selected file.  will light ().

Tap  to stop playback.

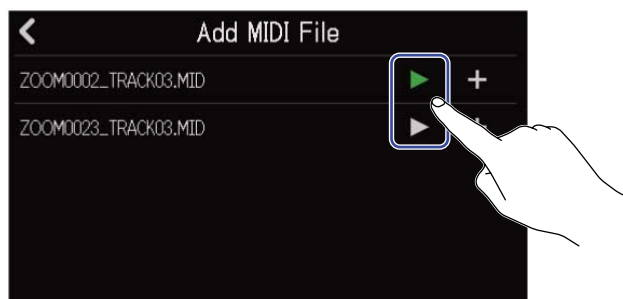

8. Tap  for the file you want to load.



This completes loading the track and opens the Track View Screen.

**NOTE:**

- An error message will appear if it cannot be loaded. Select a different file.
- Loading is not possible if the maximum number of regions in the project would be exceeded.
  - Total number of audio and rhythm regions: 50
  - Synth regions: 80

# Copying and pasting regions

Regions can be copied and pasted to other locations.

1. On the [Track View Screen](#), double-tap the region that you want to copy and paste.



This highlights that region and opens the Option Menu at the top of the screen.

2. Tap "Copy".

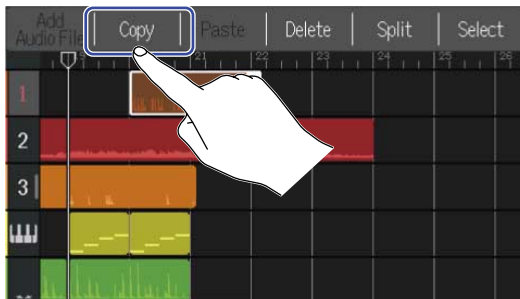

The selected region will be copied.

3. Move the playback header to the position where you want to paste.





4. Double-tap the track where you want to paste in an area that has no regions.



The Option Menu will open at the top of the screen.

5. Tap "Paste".

This pastes the copied region at the position of the playback header.



The playback header will move to the end of the pasted region.

Tap anywhere else to close the Option Menu.

**NOTE:**

- Pasting to different tracks is possible.
- Pasting to different types of tracks is not possible.

# Deleting regions

1. On the [Track View Screen](#), double-tap the region that you want to delete.



This highlights that region and opens the Option Menu at the top of the screen.

2. Tap "Delete".

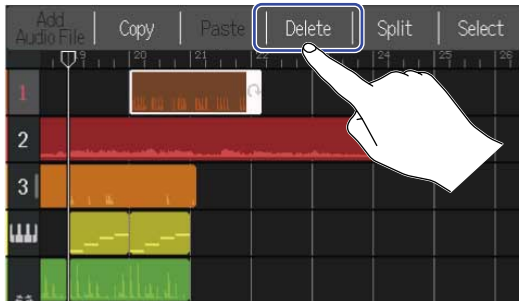

3. Tap "Execute".

The selected region will be deleted.

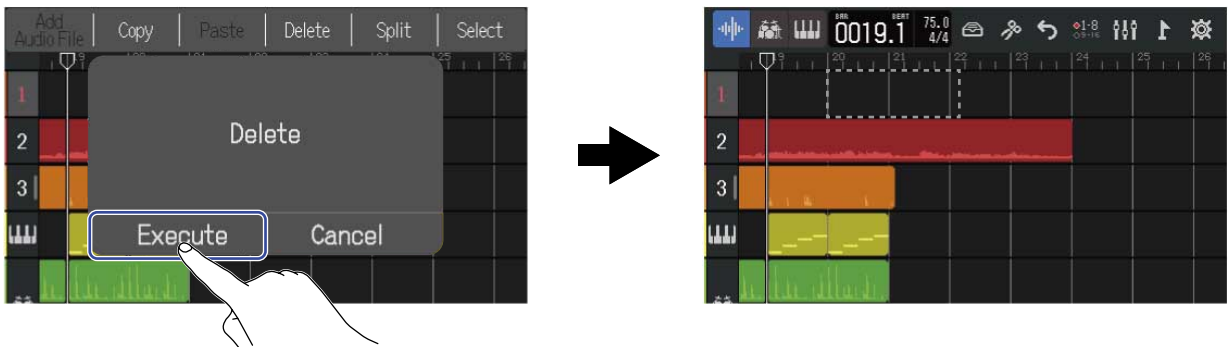

Tap "Cancel" to cancel deletion and return to the previous screen.

## ■ Deleting multiple regions simultaneously

1. On the [Track View Screen](#), double-tap a region that you want to delete.



This highlights that region and opens the Option Menu at the top of the screen.

2. Tap "Select".

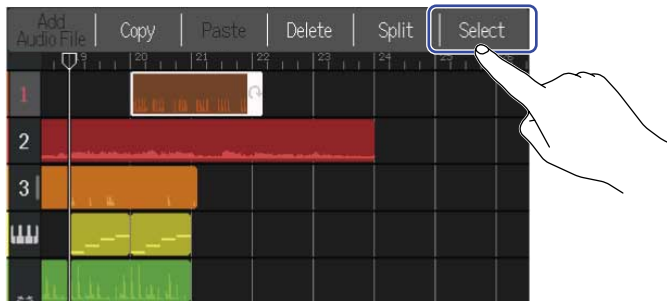

3. Tap the other regions that you want to delete.  
The selected regions will be highlighted.

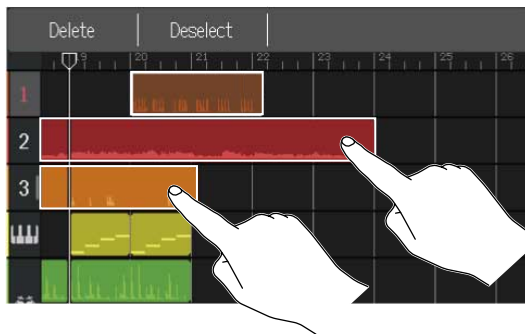

Tapping a selected region will deselect it.

4. Tap "Delete".

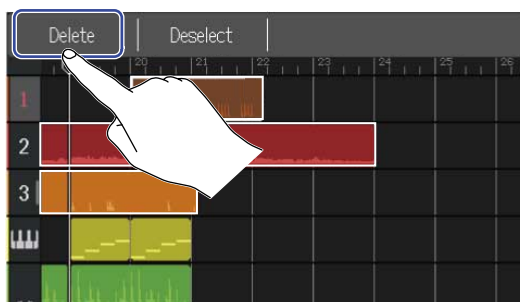

Tap "Deselect" to cancel deletion and return to the previous screen.

**5.** Tap "Execute".

The selected region will be deleted.

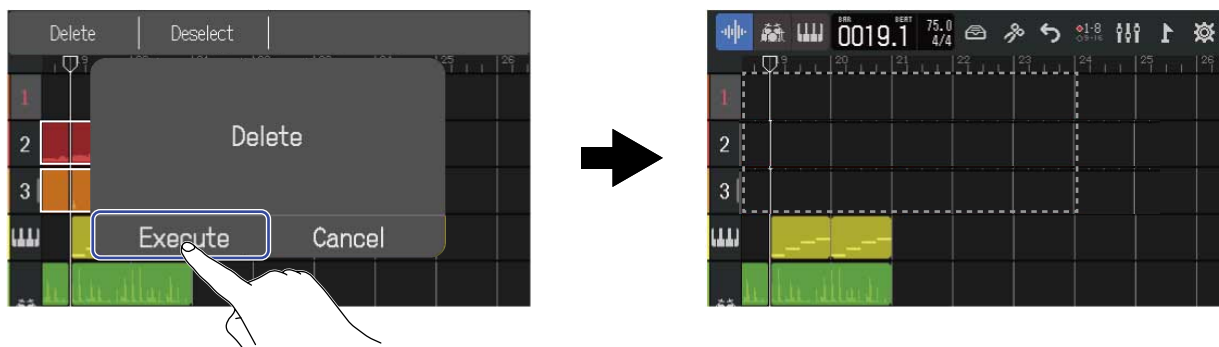

Tap "Cancel" to cancel deletion and return to the previous screen.

# Splitting regions

Regions can be split.

1. On the [Track View Screen](#), move the playback header to the position where you want to split the region.



2. Double-tap the region that you want to split.



This highlights that region and opens the Option Menu at the top of the screen.

3. Tap "Split".

This splits the selected region at the playback header position.

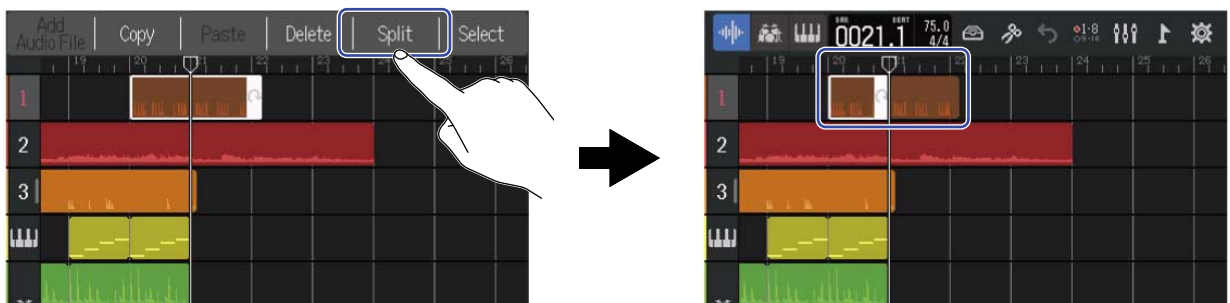

# Editing waveforms (audio/rhythm regions)

With waveform editing, audio and rhythm regions can be stretched without changing pitch and unnecessary parts can be deleted. Use the Waveform Editing Screen to edit waveforms.

## Opening the Waveform Editing Screen

1. Tap the audio or rhythm region with the waveform that you want to edit to select it. This highlights that region.



2. Tap  in the Control Bar.

The Waveform Editing Screen for the selected region opens.

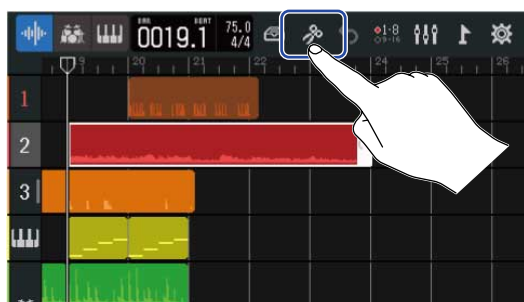

### ■ Main operations on the Waveform Editing Screen

- Zoom out/in horizontally: Pinch in/out horizontally
- Scroll horizontally: Slide left and right

### HINT:

When the Waveform Editing Screen is open, pressing  will play the region.

# Trimming regions

Regions can be trimmed to delete unwanted parts.

1. On the Waveform Editing Screen, drag left/right  at the bottom left/right of the region to set the range.

Set this to leave the necessary part. Parts outside the selected range will be cut.

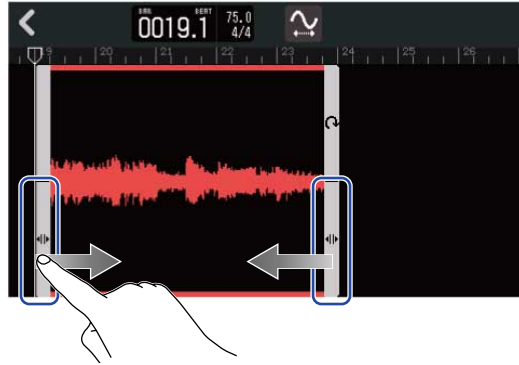

2. Tap .

This will apply the trimming and reopen the Track View Screen.

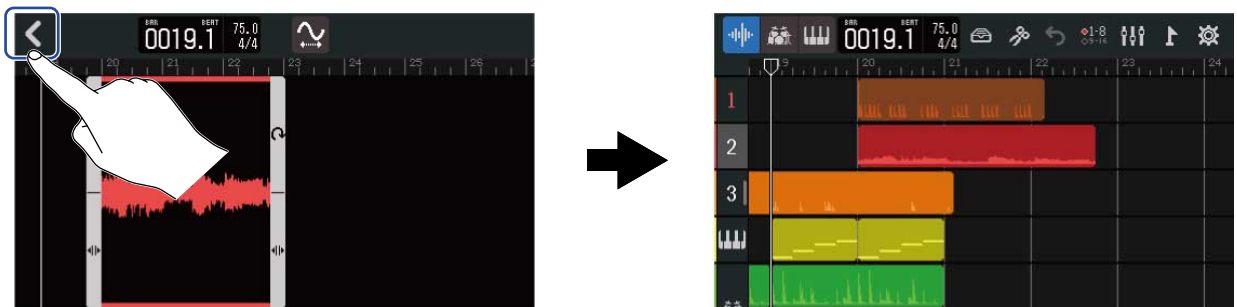

## Changing region lengths without changing pitch

The lengths of regions can be changed without changing their pitches. Regions that have had lengths changed can be saved as new audio data.

1. On the Waveform Editing Screen, tap  to turn this function on (  ) (OFF:  ).



2. Drag  left and right to adjust the length of the region.



---

### HINT:

The length can be changed in a range of 50–150% of the original region.

---

3. Tap "Done" to confirm the setting.





4. Input the file name of the edited audio region file.



See [Character Input Screen overview](#) for how to input characters.

5. When “Done” appears, tap “Close”.  
The file with the changed length will be assigned to the track.

# Completing editing

- 1. Tap  on the Waveform Editing Screen. The Track View Screen will reopen.



# Editing notes (synth regions)

Use note editing to creating MIDI data for synth playback. For example, notes can be added and deleted as well as adjusted for length and velocity. Use the Piano Roll Screen for note editing.

## Opening the Piano Roll Screen

1. On the [Track View Screen](#), tap the header of the synth track with the MIDI notes you want to edit. This highlights the track header.



2. Tap  in the Control Bar.

The Piano Roll Screen for the selected synth track opens.





### ■ Main operations on the Piano Roll Screen

- Zoom out/in horizontally: Pinch in/out horizontally
- Zoom out/in vertically: Pinch in/out vertically
- Scroll horizontally: Slide left and right
- Scroll vertically: Slide up and down

## Adding/deleting notes

Notes can be added and used to play synth sounds using their pitch, length and velocity data.

1. On the Piano Roll Screen, tap  to turn this function on (  ) (OFF:  ).



2. Add a note.

Tap the Piano Roll to add a region and note at that position.

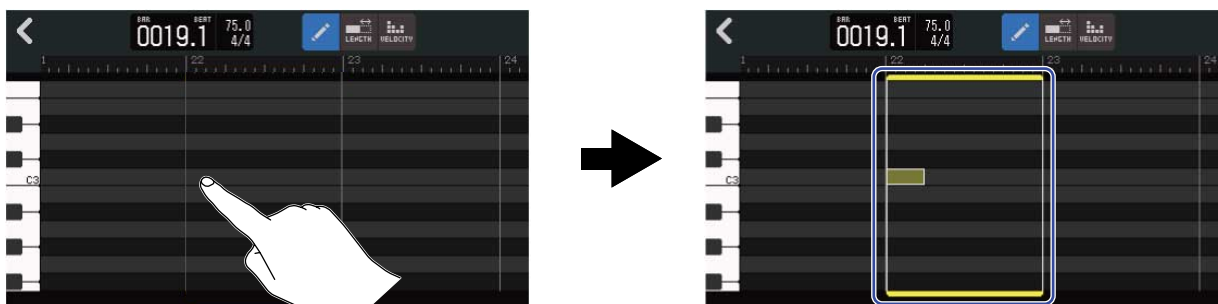

### HINT:

- The pitch of the note will be the same as on the piano keyboard shown at the left edge. Scroll up/down to raise/lower the octave.
- When the place where a note will be added is tapped, vertical guidelines will be shown, allowing the position to be checked as the note is added.

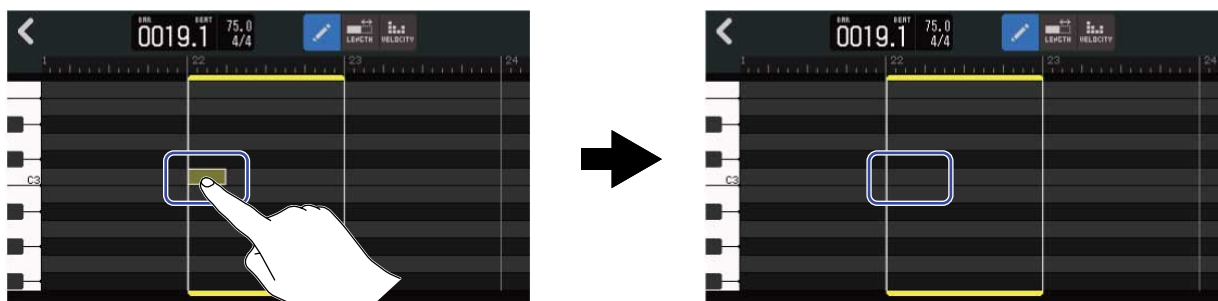

3. Delete a note.

Tap a note to delete it. The remaining region will not be deleted.



## Changing note lengths

---

1. On the Piano Roll Screen, tap  to turn this function on (  ) (OFF:  ).

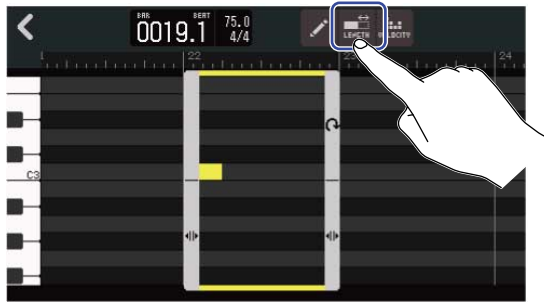

2. Tap a note and slide it left/right to change its length.

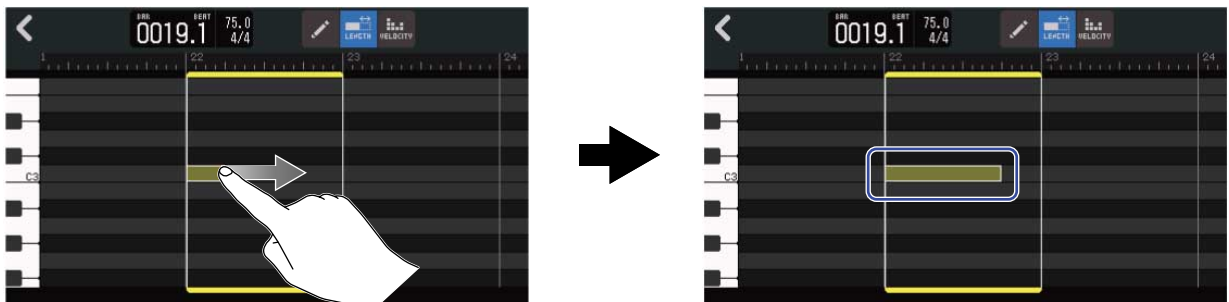

---



**HINT:**

The shortest length is a 32nd note.

---

## Adjusting note velocity (strength)

---

1. On the Piano Roll Screen, tap  to turn this function on (  ) (OFF:  ).

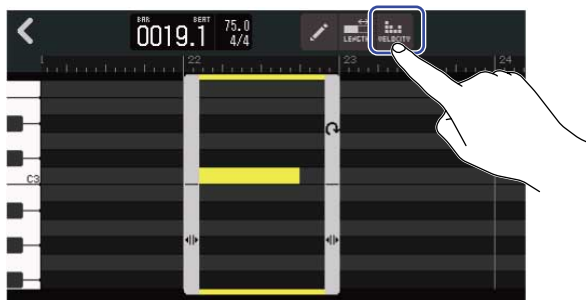

2. Tap the note for which you want to adjust the velocity.

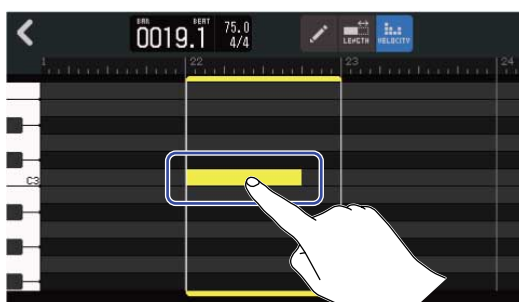

A Velocity Slider will appear at the top of the screen.

3. Slide the slider or tap  and  to adjust the velocity.

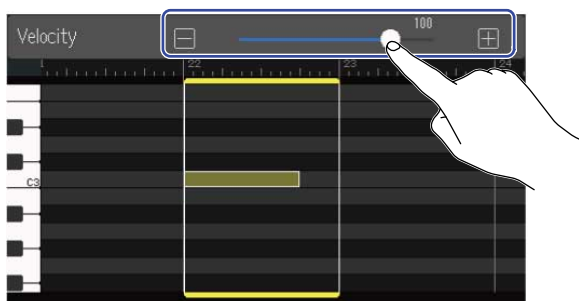

---

### HINT:

The velocity can be set from 0 to 127.

---

## Trimming regions

By trimming regions, unnecessary parts can be deleted.

1. On the Piano Roll Screen, tap  /  /  to turn them off.

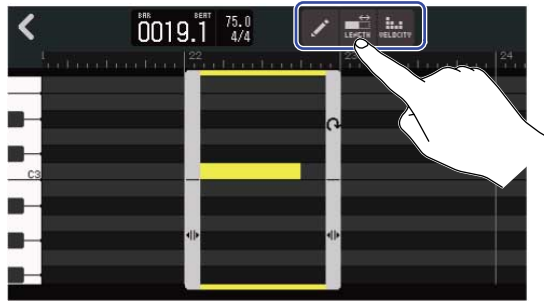

2. Drag left/right  at the bottom left/right of the region to set the range.  
Set this to leave the necessary part. Parts outside the selected range will be cut.

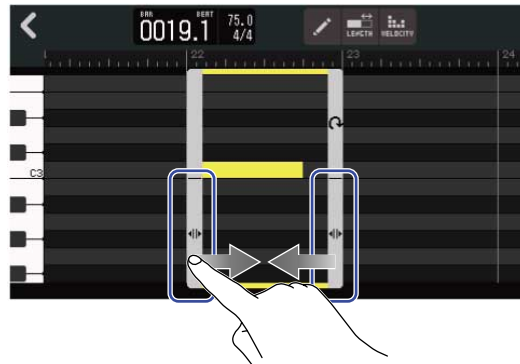

## Completing editing

1. Tap  on the Piano Roll Screen.  
The Track View Screen will reopen.

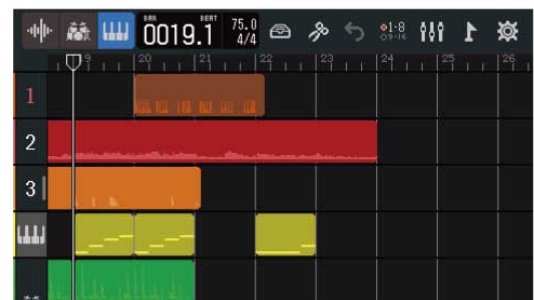

# Editing tracks

When editing tracks, tracks can be deleted and moved, synth tracks can be converted to audio tracks, and track data can be exported as audio data.

## Deleting tracks

The selected track can be deleted. All the regions in the track will also be deleted.

1. Double-tap the header of the track that you want to delete on the [Track View Screen](#).



The Option Menu will open at the top of the screen.

2. Tap "Delete".

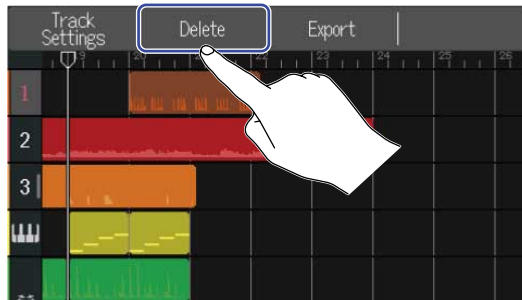

3. Tap "Execute".

This will delete the selected track and all the regions in it.

Tap "Cancel" to cancel deletion and return to the previous screen.

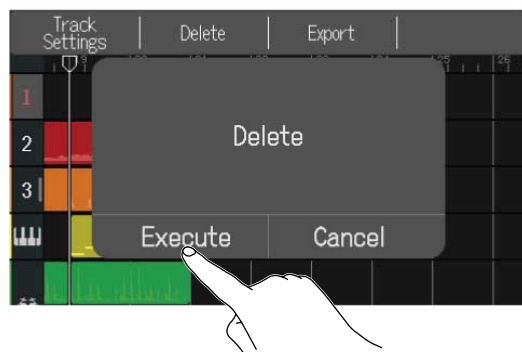

### NOTE:

Be certain before using this function because deleted track files will be completely removed from the SD card.



# Converting synth tracks to audio tracks

Only one synth track is available, so converting a synth track to an audio track makes it possible to create a new synth track.

The notes of a synth track can be performed and exported as an audio file using the currently selected sound. That synth track will be converted to an audio track, and its exported audio file can be assigned to another track.

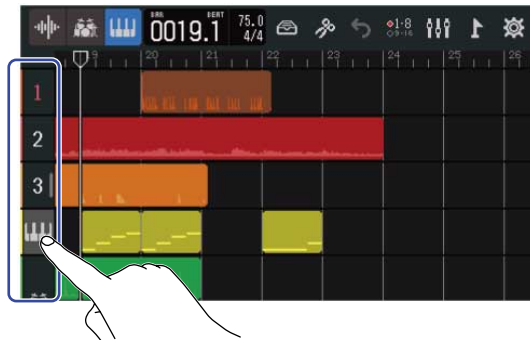

1. On the [Track View Screen](#), double-tap the header of the synth track that you want to convert to an audio track.

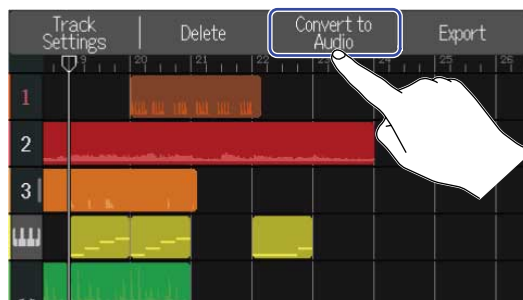

The Option Menu will open at the top of the screen.

2. Tap "Convert to Audio".



3. Slide the Length slider or tap  and .

This adjusts the exported length.

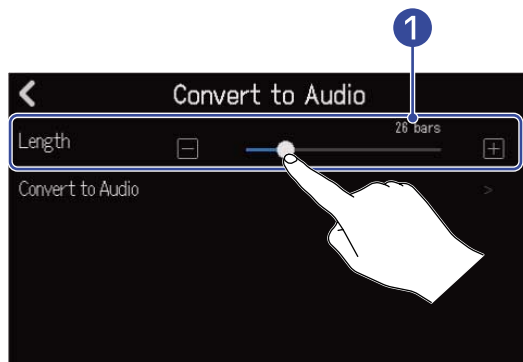

- 1 Exported length

This shows the number of bars.

4. Tap “Convert to Audio”.

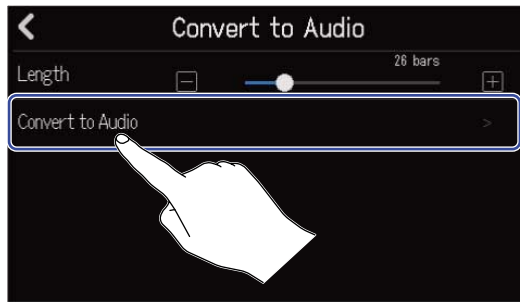

5. Input the name of the audio file to be exported.

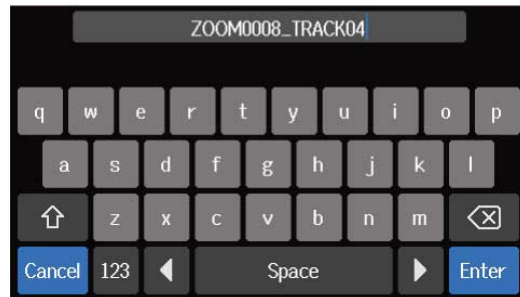

See [Character Input Screen overview](#) for how to input characters.

6. When “Done” appears, tap “Close”.  
This converts the synth track to an audio track and reopens the Track View Screen.

# Exporting tracks

Tracks can be exported to the SD card AUDIO folder as WAV files or the MIDI folder as MIDI files.



1. On the [Track View Screen](#), double-tap the header of the track that you want to export as a WAV or MIDI file.

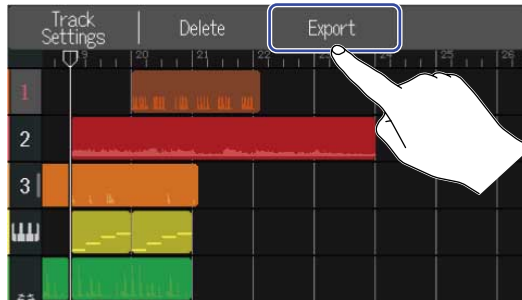

The Option Menu will open at the top of the screen.

2. Tap "Export".



3. Slide the Length slider or tap  and . This adjusts the exported length.

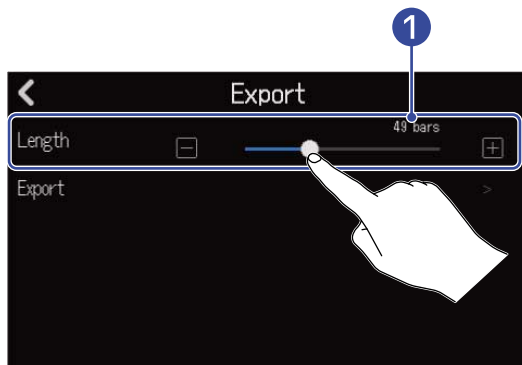

- 1 Exported length

This shows the number of bars.

4. Tap "Export".

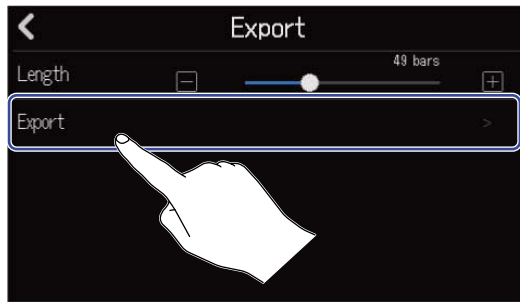

5. Input the name of the WAV or MIDI file to be exported.

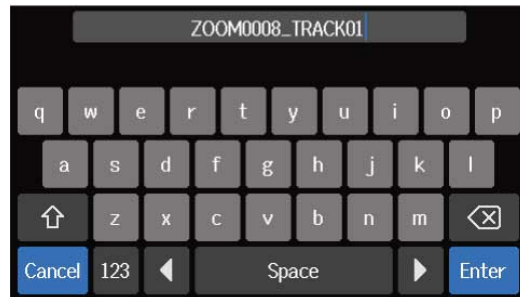

See [Character Input Screen overview](#) for how to input characters.

6. When "Done" appears, tap "Close".  
This exports the track as a WAV or MIDI file and reopens the Track View Screen.

# Reordering tracks

1. Tap the header of the track that you want to reorder on the [Track View Screen](#). This highlights the tapped track header.



2. Drag it to the desired position.

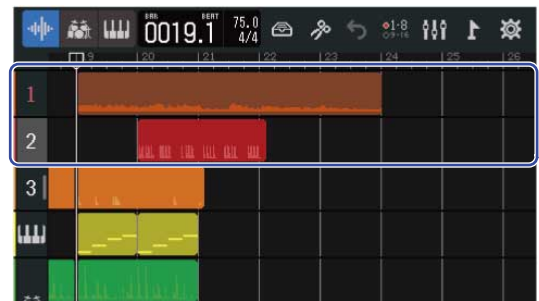

# Using markers



By adding markers with names, for example, intro, verse and chorus, to the beginnings of parts, the overall song structure can be made easy to see, which is useful when editing and mixing. Markers are shown in the Control Bar ruler.

## Adding markers

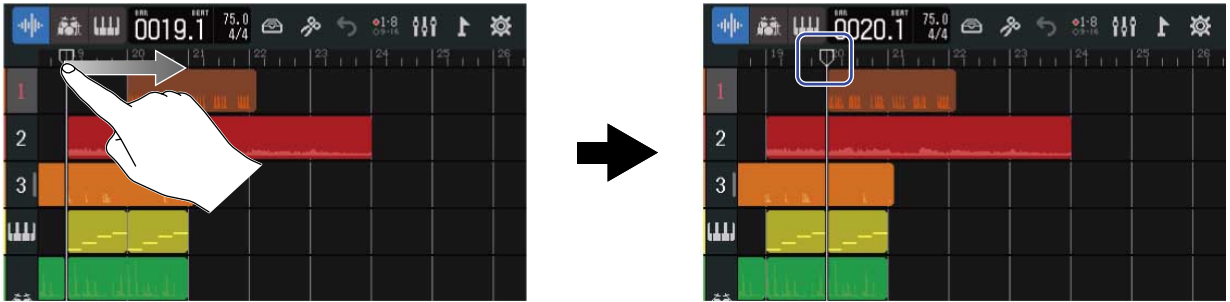
1. On the [Track View Screen](#), move the playback header to the position where you want to add a marker.



### HINT:

The playback header can be moved in ruler increments by pressing  and .

2. Tap .

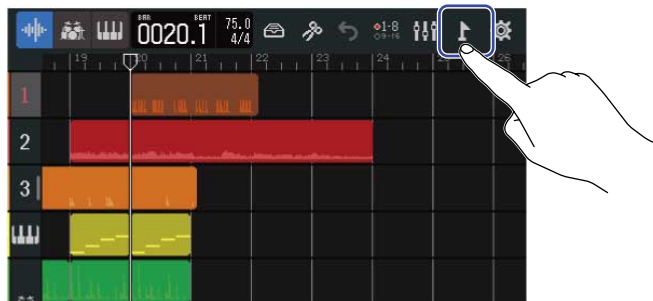

This opens the Marker Menu at the top of the screen.



3. Tap "Add".

This shows information about the marker at the playback header position. The marker name shown at the left end of the Marker Menu will be assigned to the marker.



---

**HINT:**

- Marker names will be assigned automatically each time a marker is added in the following order.  
Intro → Verse → Chorus → Bridge → Outro → Verse → Verse → ...  
Marker names can be changed in step 5.
  - By tapping   at the right end of the Marker Menu, markers can be moved one bar at a time. If another marker already exists, movement will stop at the bar next to it.
- 

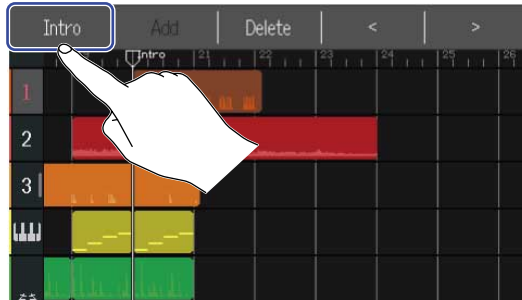
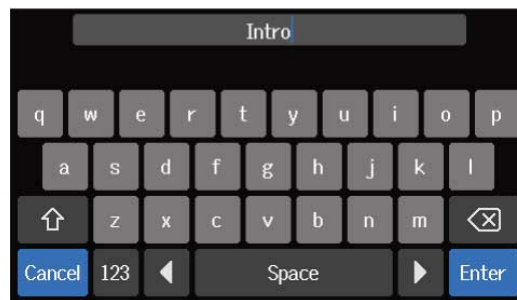
**4.** Tap a marker name in the Marker Menu.**5.** Change the marker name as necessary.

See [Character Input Screen overview](#) for how to input characters.

---

**HINT:**

Marker names can use a maximum of 10 characters.

---

**6.** When “Done” appears, tap “Close”.  
This will add the marker and reopen the Track View Screen.**HINT:**

Up to 10 markers can be added in each project.



---

# Moving marker positions

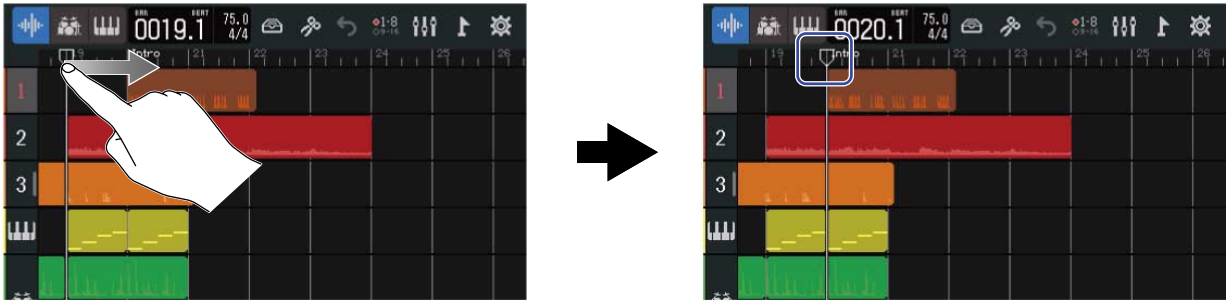
1. On the [Track View Screen](#), move the playback header to the position of the marker you want to move.



**HINT:**

The playback header can be moved in ruler increments by pressing  and .

2. Tap .

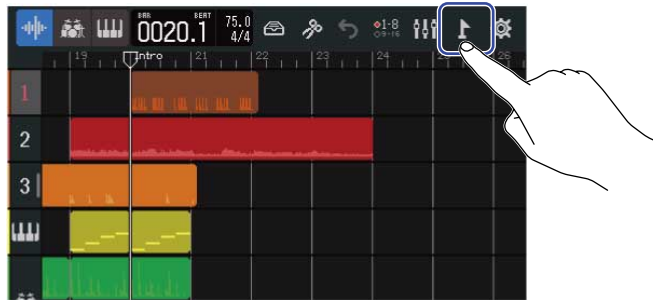

This opens the Marker Menu at the top of the screen.

3. Tap   to move the marker.

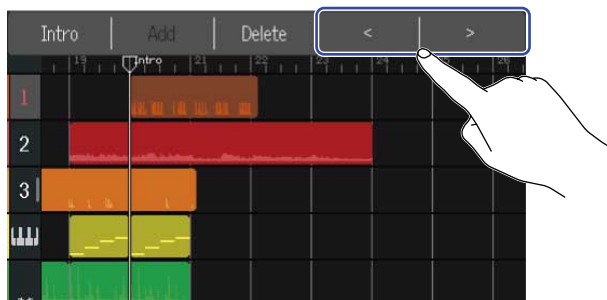

Tap anywhere else to close the Marker Menu.

**HINT:**

Movement is possible in bar increments. If another marker already exists, movement will stop at the bar next to it.



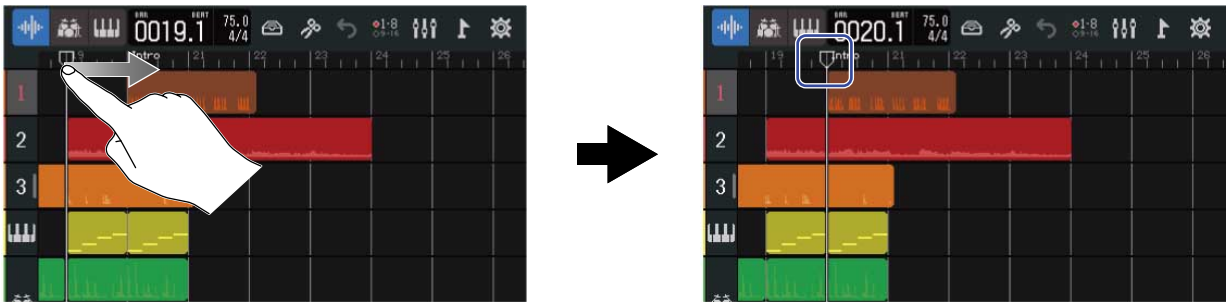

# Changing marker names

1. On the [Track View Screen](#), move the playback header to the position of the marker you want to rename.



## HINT:

The playback header can be moved in ruler increments by pressing  and .

2. Tap .

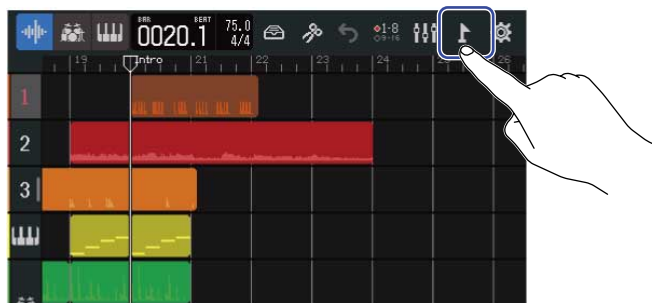

This opens the Marker Menu at the top of the screen.

3. Tap a marker name in the Marker Menu.

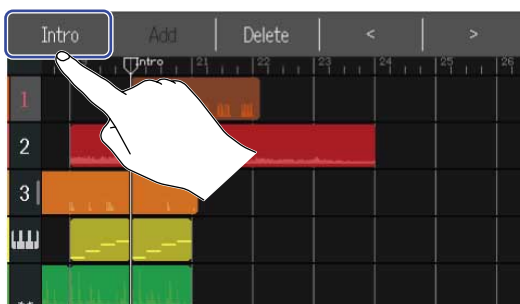

**4.** Change the marker name.



See [Character Input Screen overview](#) for how to input characters.

---

**HINT:**

Marker names can use a maximum of 10 characters.

---

**5.** When “Done” appears, tap “Close”.



This changes the marker name and returns to the Track View Screen.

# Deleting markers

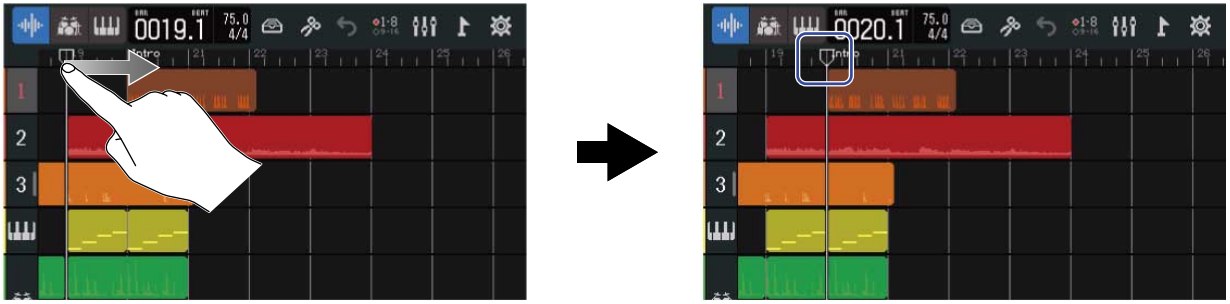
1. On the [Track View Screen](#), move the playback header to the position of the marker you want to delete.



**HINT:**

The playback header can be moved in ruler increments by pressing  and .

2. Tap .

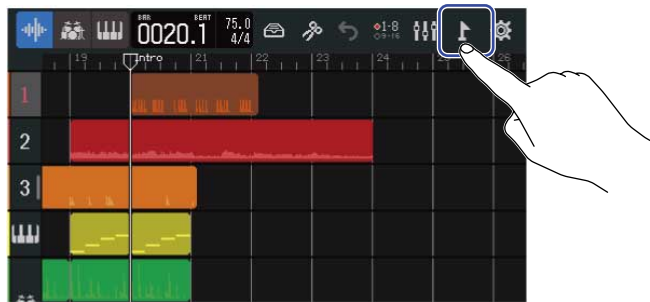

This opens the Marker Menu at the top of the screen.

3. Tap "Delete".

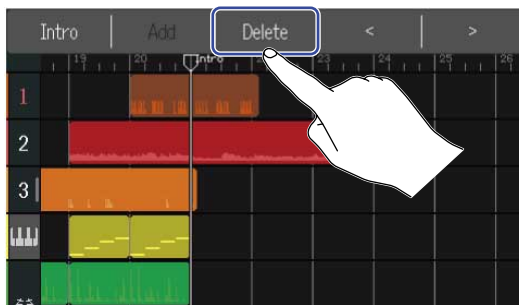

4. Tap "Execute".

Tap "Cancel" to cancel deletion and return to the previous screen.

5. When "Done" appears, tap "Close".  
The marker will be deleted.

# Mixing projects

Switch between the [Track View Screen](#) and [Level Meter View Screen](#) for different purposes when mixing.

Tap  or  to switch screens.

Switching to the Level Meter View Screen

Switching to the Track View Screen

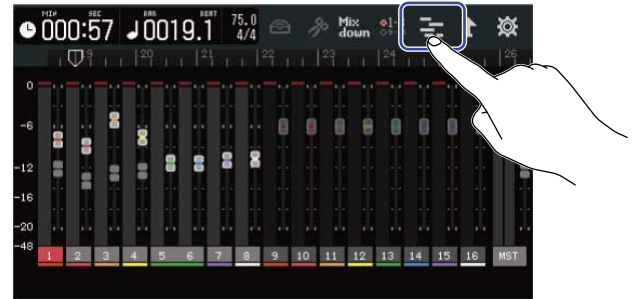

## Checking track levels

### Checking on the Track View Screen

1. Drag the track numbers right on the [Track View Screen](#).



This opens the mixer, which shows track levels with level meters.

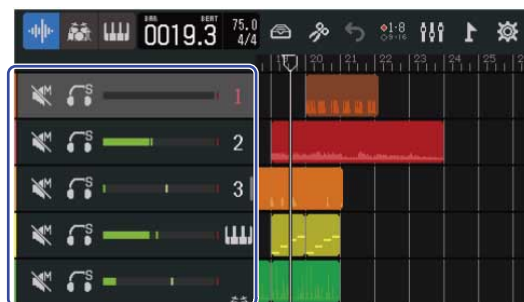

Slide the screen up and down to check the levels of other tracks.

2. Drag the track numbers left to close the mixer.



## Checking on the Level Meter View Screen

The levels of all tracks and the overall level can be checked at a glance on the Level Meter View Screen.

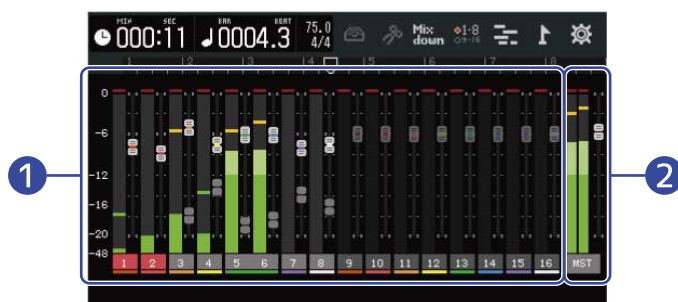



- 1 Levels and fader positions of all tracks
- 2 Overall volume and MASTER fader position

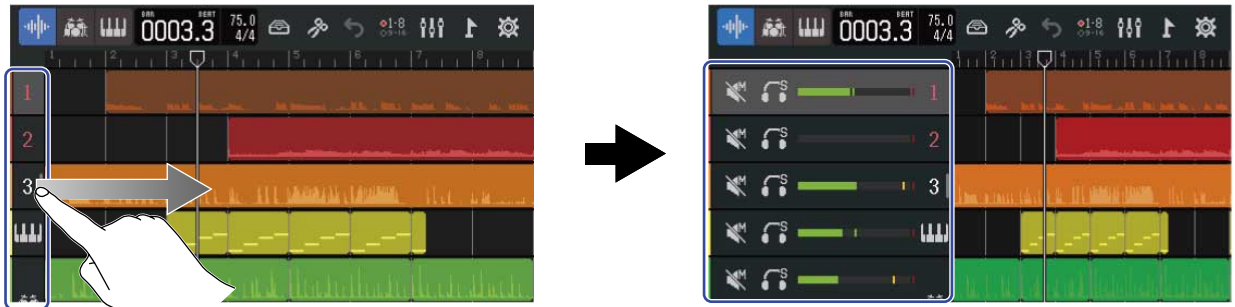

# Muting tracks

The signals of specific tracks can be muted.

1. Drag the track numbers right on the [Track View Screen](#).  
This opens the mixer.



2. Tap .

This mutes that track, and  lights ().



Multiple tracks can be muted simultaneously.  
Slide the screen up and down to mute other tracks.

3. Drag the track numbers left to close the mixer.



# Listening to selected tracks only (soloing)

Specific tracks can be selected to listen to only their signals.

1. Drag the track numbers right on the [Track View Screen](#).  
This opens the mixer.



2. Tap .

This mutes all other tracks, and  lights ().



Multiple tracks can be soloed simultaneously.  
Slide the screen up and down to solo other tracks.

3. Drag the track numbers left to close the mixer.

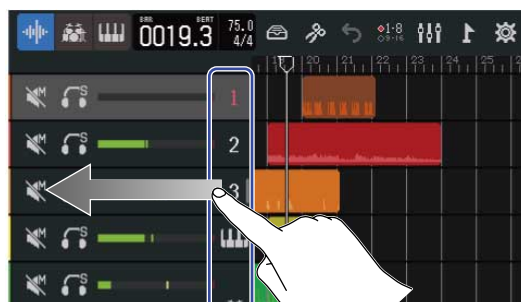

# Adjusting volume levels

1. Use the channel faders to adjust the levels of individual tracks and the MASTER fader to adjust the overall level.

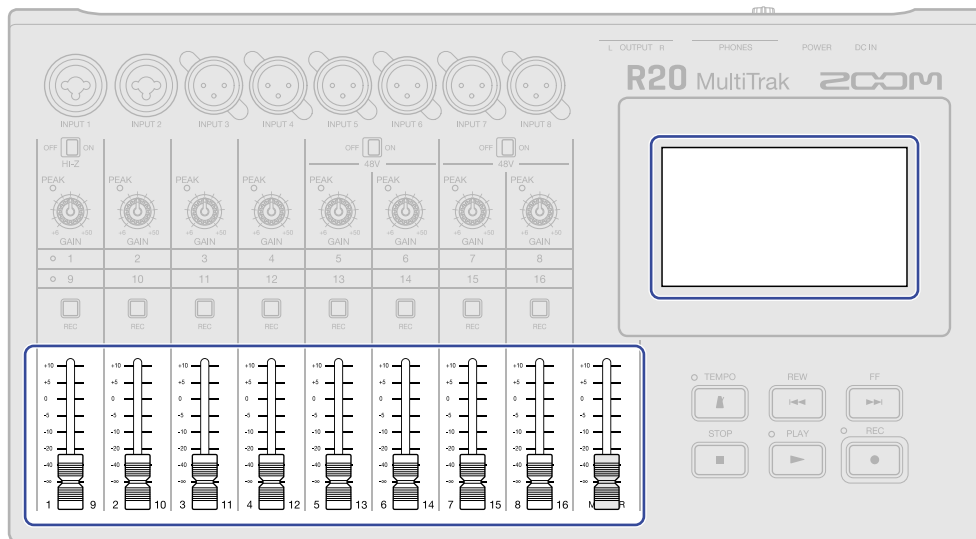

Check the levels on the [Level Meter View Screen](#).

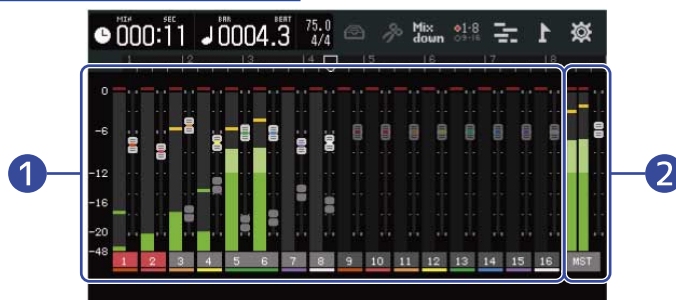



- 1 Levels and fader positions of all tracks
- 2 Overall volume and MASTER fader position



---

## HINT:

- Tap  or  in the Control Bar to switch which tracks can be controlled by the physical faders (tracks 1–8 or 9–16). (→ [Switching controlled tracks](#))
- If the position of a physical fader and its fader setting are different because tracks have been switched, for example, the physical fader will not adjust the level. First align the physical fader position with the current fader position. Then, the position of the physical fader will start adjusting the level.

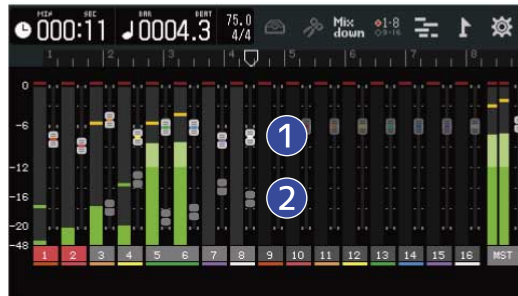

### 1 Track faders

These show the current fader position settings.

### 2 Track ghost faders

When the positions of physical faders and fader settings are different because tracks have been switched, for example, these show the physical fader positions.

---

# Switching controlled tracks

The tracks that can be controlled by the physical faders (tracks 1–8 or 9–16) can be switched.

1. Tap  or  in the Control Bar.

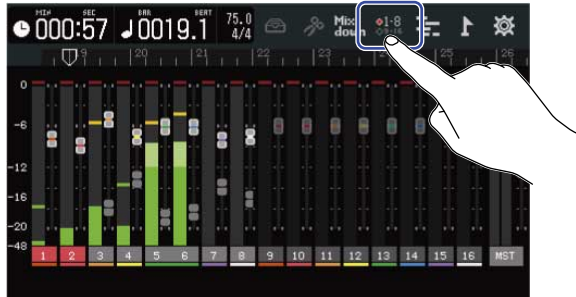

- : The physical faders can be used to control tracks 1–8.

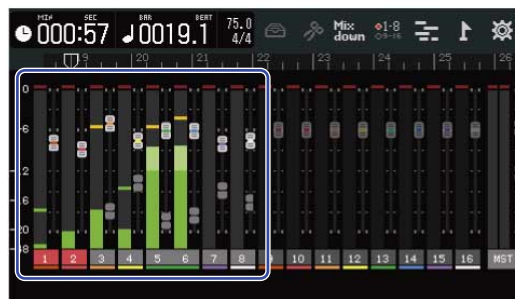

- : The physical faders can be used to control tracks 9–16.

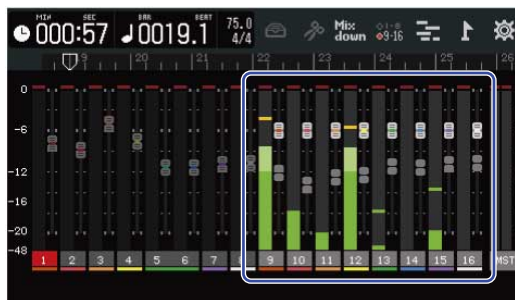

# Adjusting the panning, EQ and effects of tracks

## Adjusting panning

---

The left-right stereo panning of track playback sounds can be adjusted.

See [Adjusting monitor panning](#) for operation details.

## Adjusting EQ

---

The frequency bands of individual tracks can be boost/cut.

See [Adjusting EQ](#) for details about operation.

## Using effects

---

Effects can be applied to each track.

See [Using effects](#) for details about operation.

# Mixing down

A recorded project can be mixed and output as a stereo mixdown file (WAV).

The mixdown stereo file will be saved in the "AUDIO" folder on the SD card with the following format.

- Sample rate: 44.1 kHz
- Bit depth: As set during project creation (→ [Creating empty projects using specific settings](#))

1. Tap **Mix down** on the [Level Meter View Screen](#).

**Mix down** will light (**Mix down**).

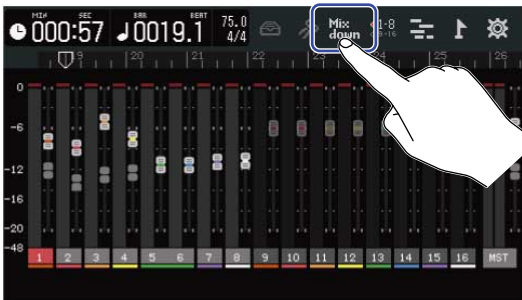

2. Press .

This starts mixdown from the beginning of the project.

Level adjustments made with the channel and MASTER faders during mixdown will affect the mixdown recording.

3. Press  to stop the mixdown.

# Managing projects

Projects created on the R20 are saved on the SD card.

The names of projects saved on SD cards can be changed. These projects can also be copied and deleted and their creation date/time and format data can be checked.

When a USB flash drive is connected to the R20, projects can be saved on it or loaded from it, and audio data and MIDI files can also be loaded from it.

Conduct these operations from the Project Option Screen.

## SD card folder and file structure

When recording with the R20, folders and files are created on SD cards in the following manner.

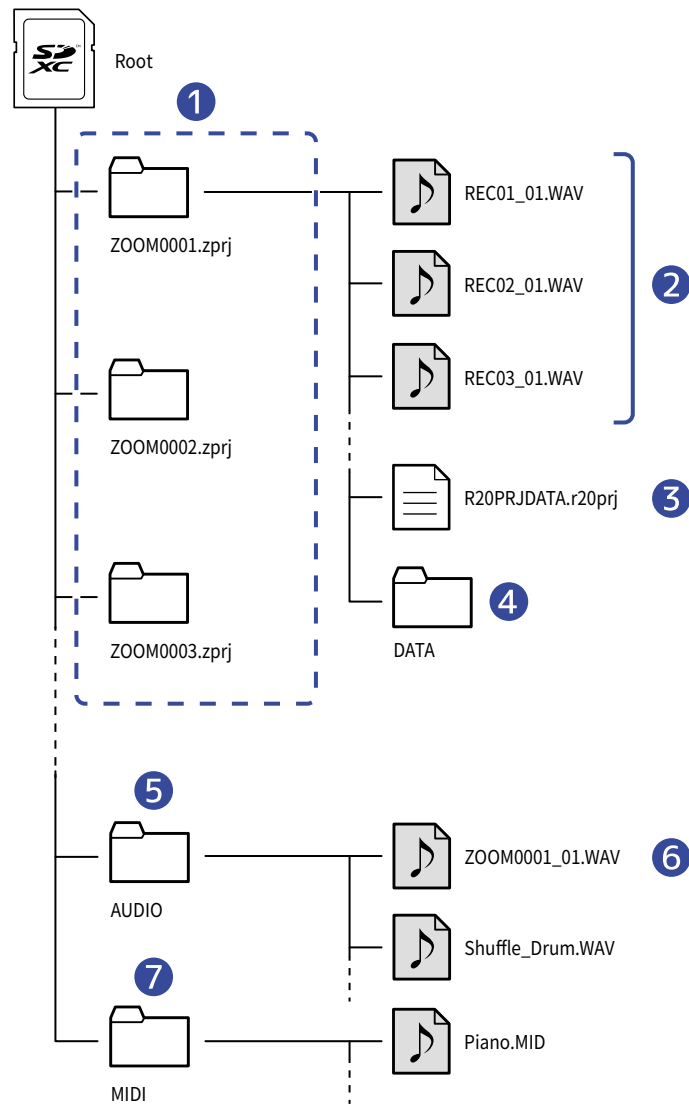

### 1 Project folders

These contain project recording data and settings.

Folders are created with the names "ZOOM0001" – "ZOOM9999".

## 2 Audio files recorded for each track

Audio files will be created with names as follows.

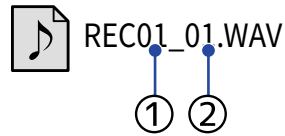

① Track number

② Recording number ("01" is the first recording, followed by "02", "03" and so on.)

Example: The name of the file for the second recording made on track 4 would be "REC04\_02.WAV".

## 3 Project file

Project specific settings are saved in this file.

## 4 DATA folder

Data necessary for the project structure are saved in this folder.

## 5 AUDIO folder

This stores WAV files to be added to projects. Put WAV files that you want to load in the R20 here.

In addition, mixdown audio files as well as WAV files exported following the instructions in [Rendering projects as WAV files](#) are stored here.

## 6 Mixdown audio file

The number after the project name in the file name shows the mixdown number.

## 7 MIDI folder

This stores MIDI files to be added to projects. Put MIDI files that you want to load in the R20 here.

# USB flash drive folder and file structure

When a USB flash drive is connected to the R20, folders are created as shown below.

The R20 can write project data to the following folders and load necessary files from them.

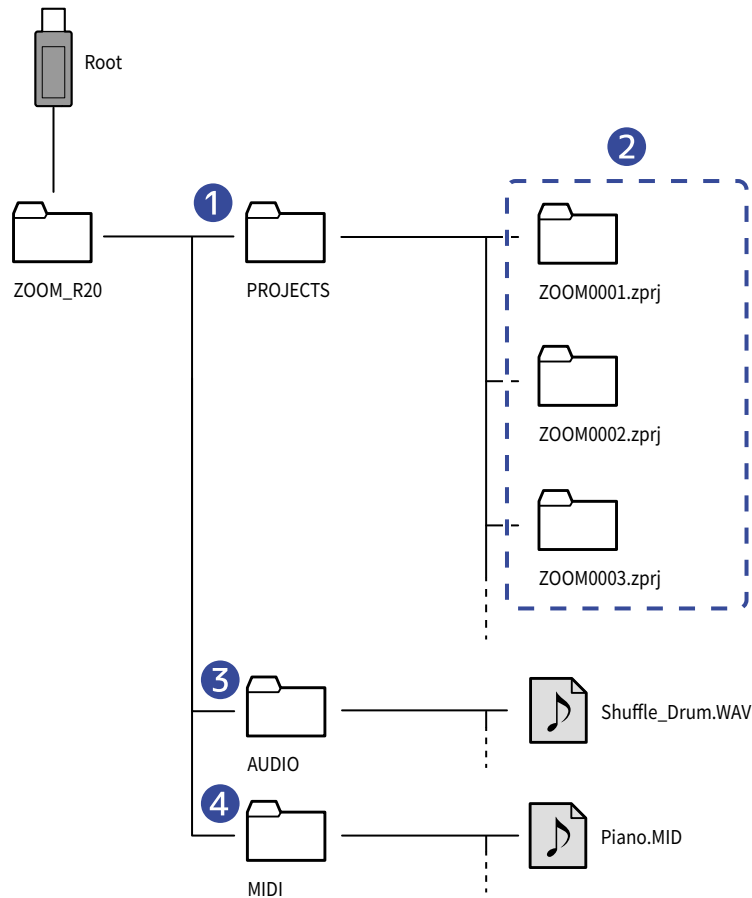

## 1 Folder for saving projects

This stores projects saved on the USB flash drive. Save projects that you want to load in the R20 here.

## 2 Project folders

These contain project recording data and settings.

## 3 AUDIO folder

This stores WAV files to be added to projects. In addition, WAV files exported following the instructions in [Rendering projects as WAV files](#) are stored here. Put WAV files that you want to load in the R20 here.

## 4 MIDI folder

This stores MIDI files to be added to projects. Put MIDI files that you want to load in the R20 here.

## Connecting USB flash drives

---

Connect USB flash drives to the USB port.

Use USB flash drives that are compatible with USB Type-C.

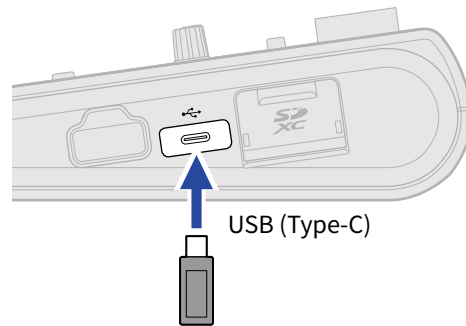

**NOTE:**

Never disconnect a USB flash drive when data is being transferred.



# Opening the Project Option Menu

Manage projects on the Project Option Screen

1. Tap  on the Home Screen (Track View Screen/Level Meter View Screen).

Track View Screen



Level Meter View Screen

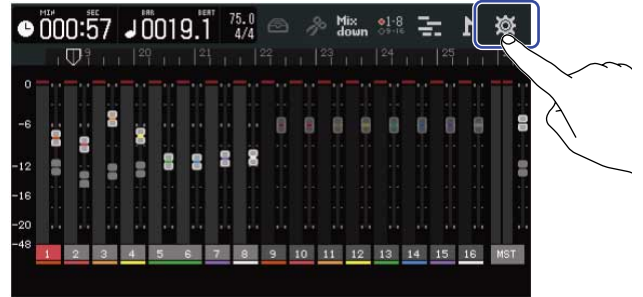

This opens the Project Settings Screen.

2. Tap "Projects" on the Project Settings Screen.

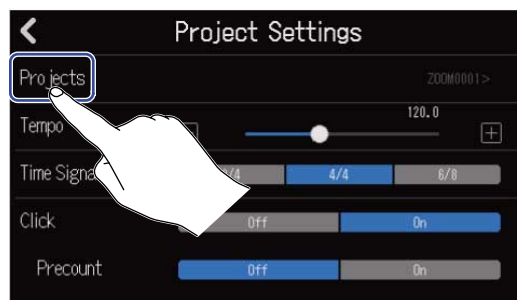

This opens the Projects Screen.

3. Tap the project you want to manage.

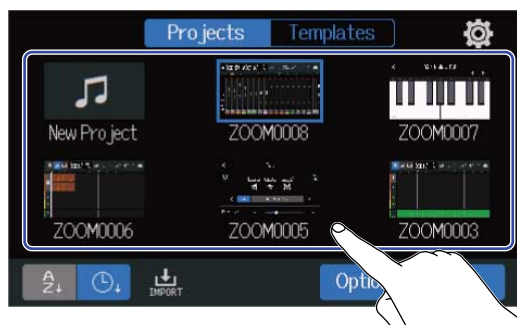

The selected project will be framed in blue.

#### 4. Tap "Option".

This opens the Project Option Screen for the selected project.

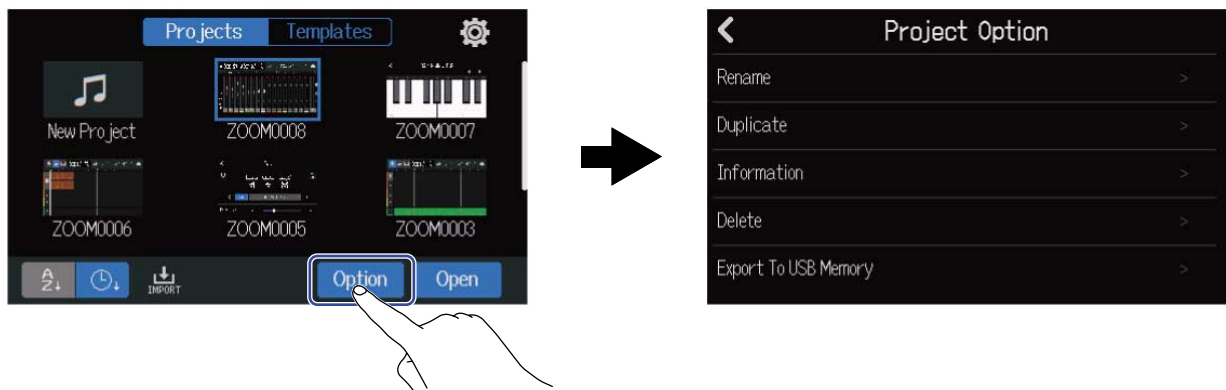

## Changing project names

1. Tap “Rename” in the Project Option Menu (→ [Opening the Project Option Menu](#)) of the project that you want to rename.

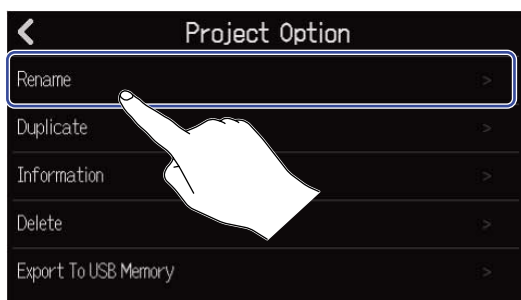

2. Change the project name.



See [Character Input Screen overview](#) for how to input characters.

### NOTE:

- An error message will appear if the same name already exists after changing a project name. If this happens, change the project name.
- Usable project names can have a maximum of 50 characters, including their extensions.

3. When “Done” appears, tap “Close”.

# Duplicating projects

1. Tap “Duplicate” in the Project Option Menu (→ [Opening the Project Option Menu](#)) of the project that you want to duplicate.

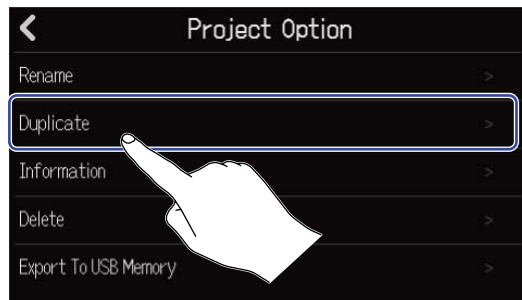

2. Input the name for the duplicated project.

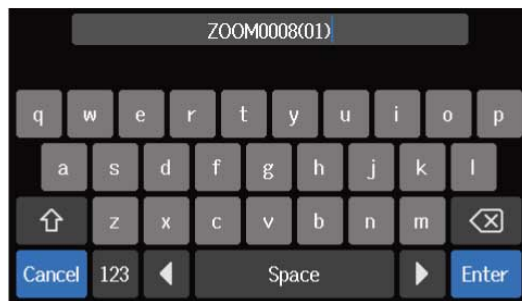

See [Character Input Screen overview](#) for how to input characters.

## NOTE:

- An error message will appear if the same name already exists after changing a project name. If this happens, change the project name.
- Duplication is not possible if an SD card does not have enough open space.
- Duplication is not possible if 1000 projects already exist on the SD card.

3. When “Done” appears, tap “Close”.  
This completes duplication and reopens the original screen.

## Checking project information

1. Tap "Information" in the Project Option Menu (→ [Opening the Project Option Menu](#)) of the project with information that you want to check.

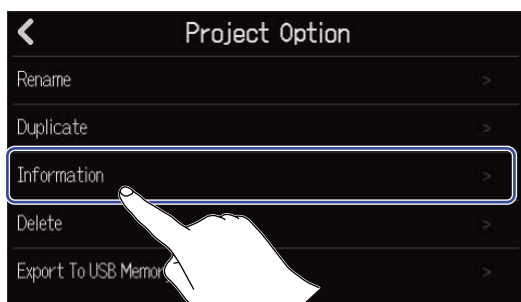

This opens the project Information Screen where you can check the following information.

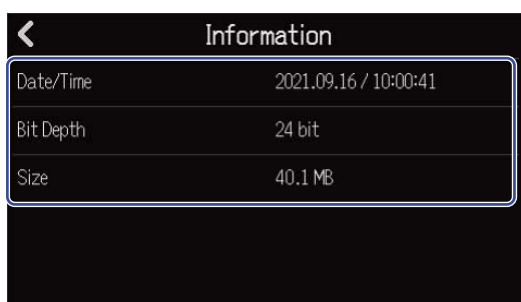

Item	Explanation
Date/Time	Date and time of project creation
Bit Depth	Recording format
Size	Project size

# Deleting projects

1. Tap "Delete" in the Project Option Menu (→ [Opening the Project Option Menu](#)) of the project that you want to delete.

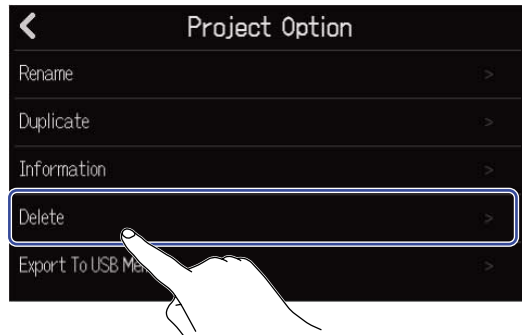

2. Tap "Execute".

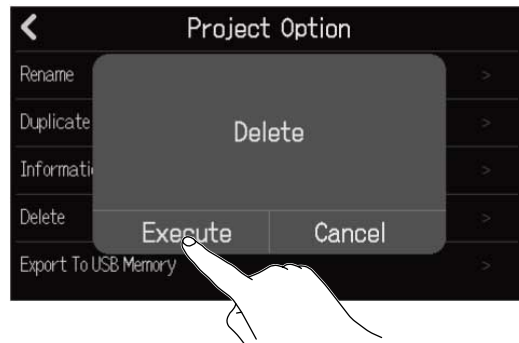

Tap "Cancel" to cancel deletion and return to the previous screen.

3. When "Done" appears, tap "Close".  
This deletes the selected project and reopens the Projects Screen.

# Rendering projects as WAV files

Projects can be rendered in the following format to the AUDIO folder on an SD card or the ZOOM\_R20 > AUDIO folder on a USB flash drive.

- Stereo WAV file
- Sample rate: 44.1 kHz
- Bit depth: As set during project creation (→ [Creating empty projects using specific settings](#))

## NOTE:

To render to a USB flash drive, connect it to the USB (Type-C) port. (→ [Connecting USB flash drives](#))

1. Tap “Rendering” on the Project Settings Screen (→ [Opening the Project Settings Screen](#)).

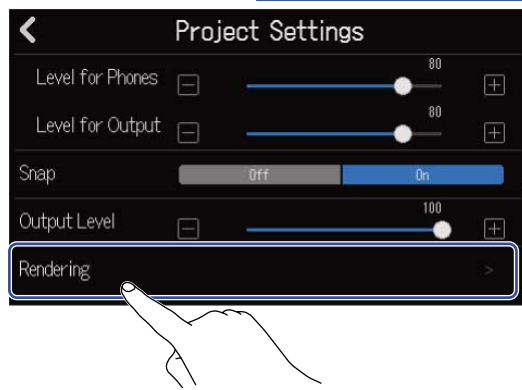

2. Slide the Length slider or tap  and .

This adjusts the length rendered from the beginning of the project.

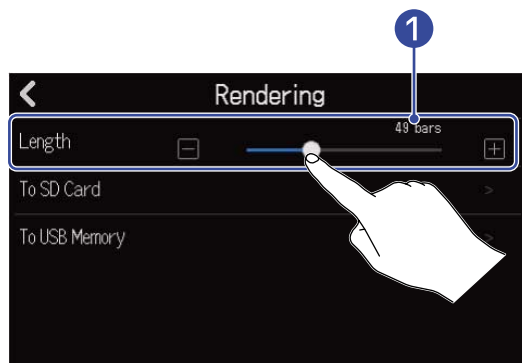

- 1 **Rendered length**

This shows the number of bars.

3. Tap where the rendered stereo WAV file should be saved.

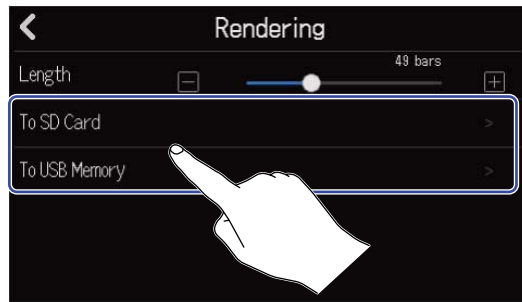

Setting	Explanation
To SD Card	This renders to the SD card.
To USB Memory	This renders to the USB flash drive.

4. Input the file name.



See [Character Input Screen overview](#) for how to input characters.

**NOTE:**

- An error message will appear if a file with the same name already exists. If this happens, change the file name.
- Exporting is not possible if the SD card or USB flash drive does not have enough open space.

5. When "Done" appears, tap "Close".

This completes rendering of the WAV file and reopens the Project Settings Screen.



# Saving projects to USB flash drives

Projects are saved to SD cards, but backups can also be saved to USB flash drives.

Projects will be saved in the "PROJECTS" subfolder of the "ZOOM\_R20" folder on a USB flash drive.

1. Connect a USB flash drive to the USB (Type-C) port (→ [Connecting USB flash drives](#)).
2. Tap "Export To USB Memory" in the Project Option Menu (→ [Opening the Project Option Menu](#)) of the project that you want to save.

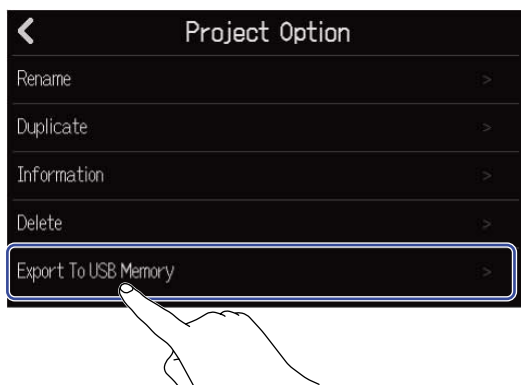

This opens the Project Name Input Screen.

3. Input the project name.



See [Character Input Screen overview](#) for how to input characters.

## NOTE:

- An error message will appear if a project with the same name already exists. If this happens, change the project name.
- Saving is not possible if a USB flash drive does not have enough open space.
- Usable project names can have a maximum of 50 characters, including their extensions.

4. When "Done" appears, tap "Close".  
This completes saving and reopens the Project Option Screen.

# Importing projects from USB flash drives

Projects saved in the ZOOM\_R20 > PROJECTS folder on a USB flash drive can be imported to SD cards. (→ [USB flash drive folder and file structure](#))

1. Connect a USB flash drive to the USB (Type-C) port (→ [Connecting USB flash drives](#)).

2. Tap  on the Projects Screen (→ [Opening projects](#)).

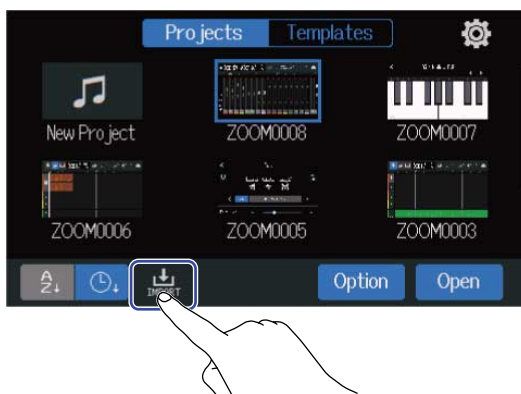

3. Tap the project that you want to import.

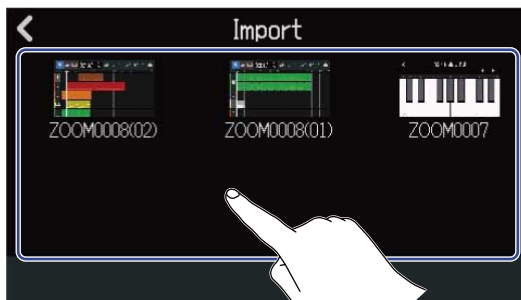

4. Input the project name.

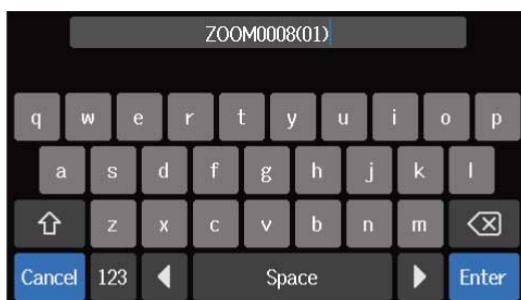

See [Character Input Screen overview](#) for how to input characters.

## NOTE:

- An error message will appear if a project with the same name already exists. If this happens, change the project name.
- Importing is not possible if an SD card does not have enough open space.

**5.** When “Done” appears, tap “Close”.

This completes importing and reopens the Import Screen (shown in step 3).

# Using as an audio interface

---

The R20 can be used as an 8-in/4-out or 2-in/2-out audio interface.

The R20 can send 8 separate channels of track audio signals or a mixed stereo signal to a computer, smartphone or tablet.

Either 2 or 4 channels of audio signals can be input from a computer, smartphone or tablet.

## Installing drivers

### Windows computers

---

1. Download the R20 Driver to the computer from [zoomcorp.com](http://zoomcorp.com).

**NOTE:**

The R20 Driver can be downloaded from the above website.

2. Launch the installer and follow its instructions to install the R20 Driver.

**NOTE:**

See the Installation Guide included in the driver package for detailed installation procedures.

### Smartphones, tablets and Mac computers

---

No drivers are necessary for use with smartphones, tablets and Mac computers.

# Connecting computers, smartphones and tablets

1. Tap  on the Projects Screen (→ [Opening projects](#)).



2. Tap "Audio Interface".

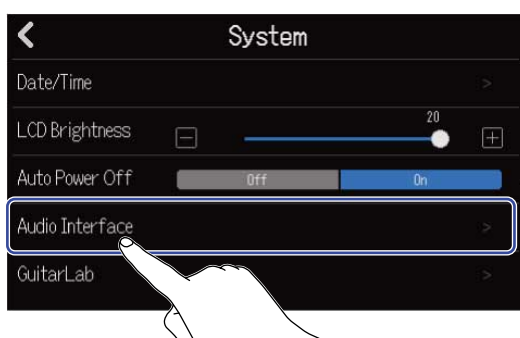

3. Tap a mode to select it.

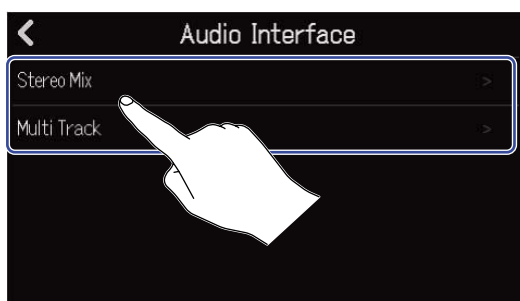

Setting	Explanation
Stereo Mix	This mode sends a stereo signal that is a mix of all tracks.
Multi Track	This 8-in/4-out connection mode sends the signals of each track separately to the computer, smartphone or tablet.

The Level Meter View Screen for the selected mode will open.



4. Use a USB cable to connect the R20 with a computer, smartphone or tablet.

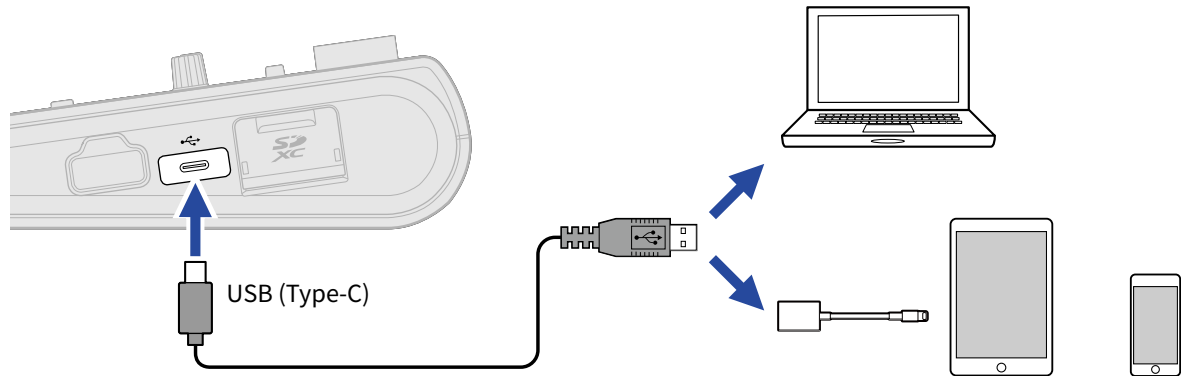

**NOTE:**

- Use a USB (Type-C) cable that supports data transfer.
- When connecting to a computer, set the R20 as the sound device.
- The R20 cannot operate on USB bus power.
- Use a Lightning to USB Camera Adapter (or Lightning to USB 3 Camera Adapter) to connect to an iOS/iPadOS device with a lightning connector.

**HINT:**

- To make sound monitoring, output level and other settings, see [Making audio interface settings](#).
- When in Stereo Mix mode, the stereo signal mixed by the R20 is transmitted. See [Mixing projects](#) for details about mixing.

## Disconnecting computers, smartphones and tablets

---

1. Tap  on the audio interface Level Meter View Screen.

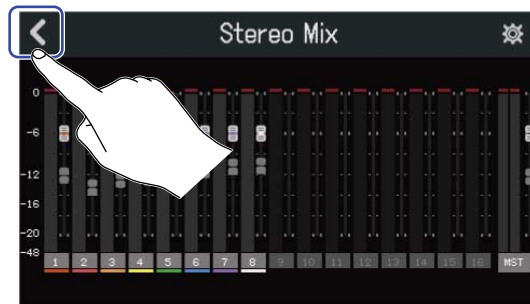

2. Tap "Execute".



This disables the audio interface function and opens the Audio Interface Screen.  
Tap "Cancel" to return to the previous screen.

3. Disconnect the USB cable connecting the R20 and the computer, smartphone or tablet.

# Making audio interface settings

Settings can be made, including for the monitoring sound and output level.

## Setting direct monitoring

This directly outputs the sound being recorded by the R20 before sending it to the computer, smartphone or tablet. This enables monitoring without latency (direct monitoring).

1. Tap  on the audio interface Level Meter View Screen.



2. Tap "Direct Monitor" "On" or "Off".

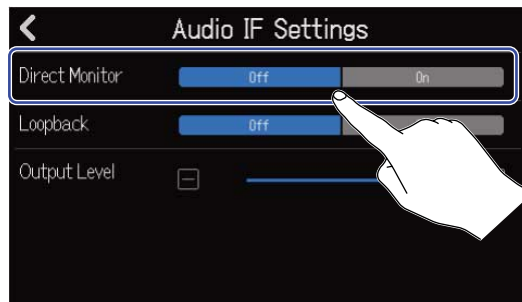

Setting	Explanation
Off	This turns off direct monitoring. This outputs the sound being recorded by the R20 after sending it to the computer, smartphone or tablet.
On	This turns on direct monitoring.

### NOTE:

- When in Multi Track mode (→ [Connecting computers, smartphones and tablets](#)), the direct monitoring sound is from the pre-fader mix, so fader adjustments will not affect the volume.
- When in Stereo Mix mode (→ [Connecting computers, smartphones and tablets](#)), the direct monitoring sound is from the post-fader mix, so fader adjustments will affect the volume.



## Setting loopback (Stereo Mix mode only)

This function allows the playback sound from the computer, smartphone or tablet and the R20 inputs to be mixed and sent back (looped back) to the computer, smartphone or tablet.

This function can be used to add narration to music played back from a computer and to record the mix or stream it on a computer, for example.

1. Tap  on the audio interface Level Meter View Screen.



2. Tap "Loopback "On" or "Off".

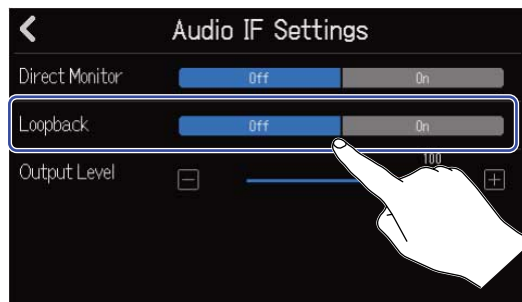



Setting	Explanation
Off	This turns off the Loopback function.
On	This turns on the Loopback function.

## Setting the output level

The levels of signals output from the OUTPUT jacks can be adjusted.

1. Tap  on the audio interface Level Meter View Screen.



2. Slide the Output Level slider or tap  and .

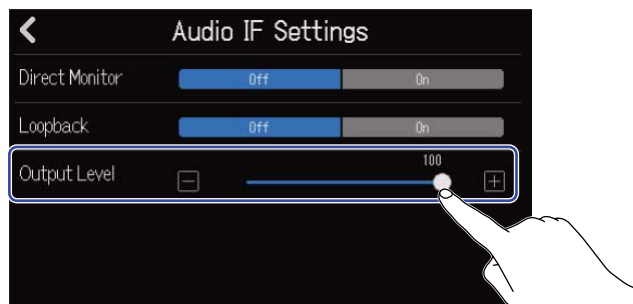

**NOTE:**

This can be set from 0 to 100.

# Using the R20 as a control surface

When the R20 is connected by USB and used as an audio interface, its keys and faders can be used to control DAW transport and mixing operations.

## Enabling control surface use

1. Connect to a computer as an audio interface in MultiTrack mode (→ [Connecting computers, smartphones and tablets](#))

2. Tap .

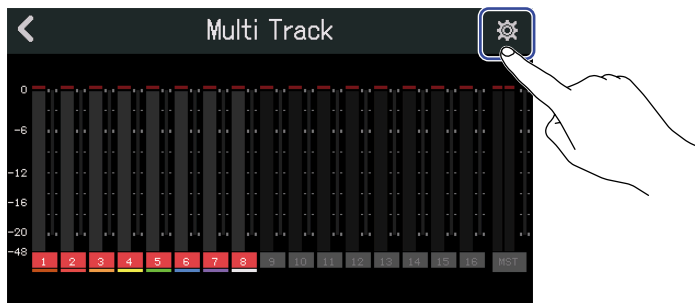

3. Tap "DAW Control", and set it to "On".

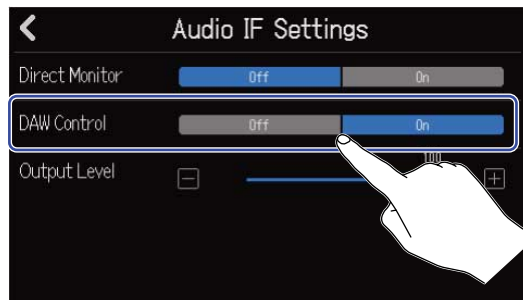

4. Tap .

This returns to the previous screen.

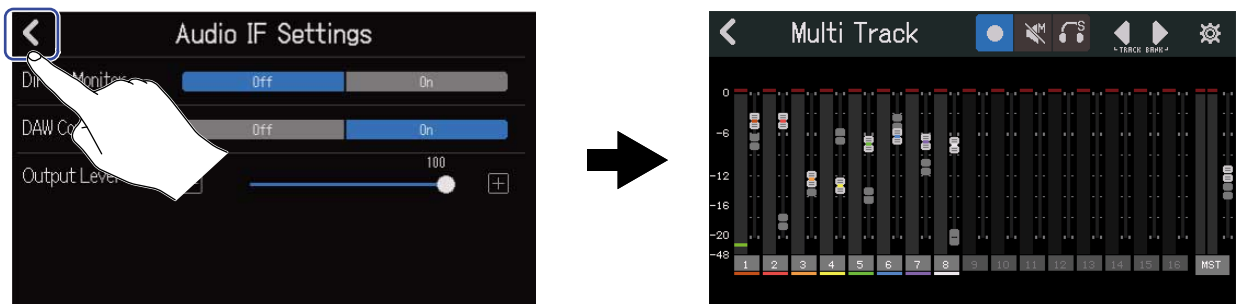

# Making DAW settings







The R20 control surface function conforms to the Mackie Control standard.

In the DAW settings menu, add "Mackie Control" to the "Devices", and select "ZOOM R20" for MIDI input and output. For details, see the manual of the DAW being used.

## R20 functions

The buttons and faders as well as on-screen buttons on the R20 can be operated to control various DAW functions.

### Button and fader functions

Button/fader	Explanation
	Turn Rec/Mute/Solo on/off for corresponding tracks
Channel faders	Adjust volumes of corresponding tracks
Master fader	Adjust master volume
	Search backward
	Search forward
	Stop
	Start playback
	Record

### Screen button functions



#### 1 Rec/Mute/Solo buttons

Use to set the track REC button function.

#### 2 Track Bank button

Use to switch the bank.

# Using Guitar Lab

The Guitar Lab application can be used on a computer (Mac/Windows) to add effects that are distributed online as well as to edit and back up patch memories, for example.

## HINT:

- Download Guitar Lab from the ZOOM website. ([zoomcorp.com](http://zoomcorp.com))
- See the app manual for setting and operation procedures.

## Connecting to a computer

1. Tap  on the Projects Screen (→ [Opening projects](#)).



2. Tap "Guitar Lab".  
This opens the Guitar Lab Screen.

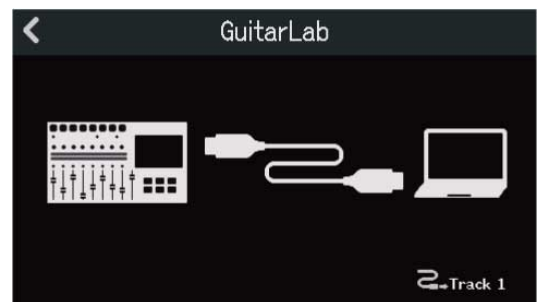
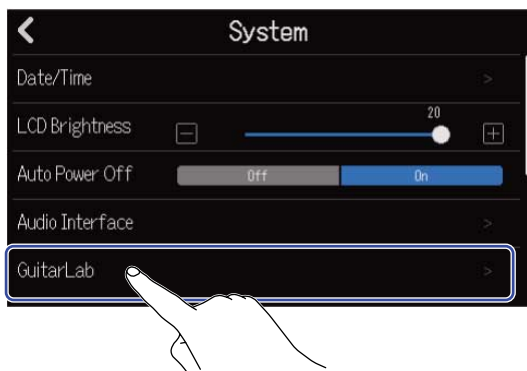

**3.** Use a USB (Type-C) cable to connect the R20 and the computer.

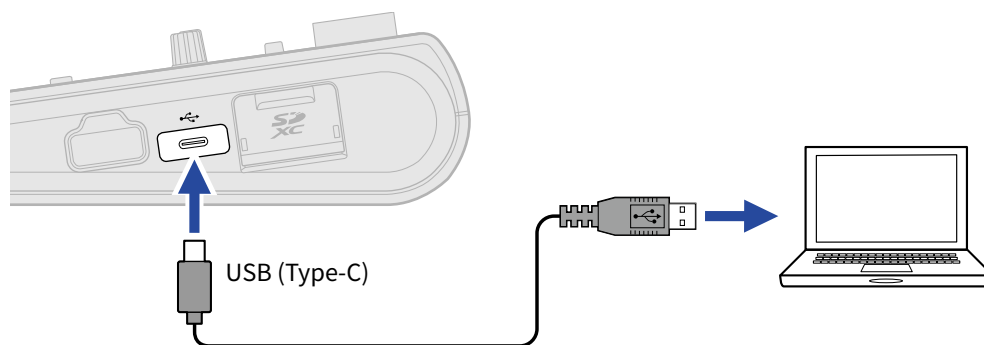

**NOTE:**

- Use a USB (Type-C) cable that supports data transfer.
- The R20 cannot operate on USB bus power.

**4.** Launch Guitar Lab on the computer.

**5.** Press  to select the track you want to use effects on.

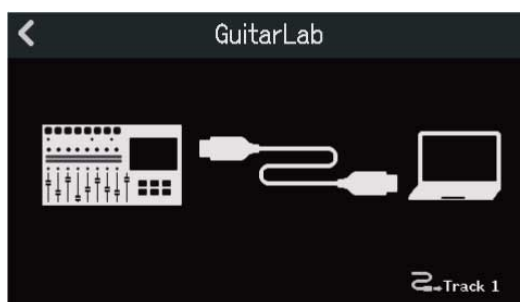

## Disconnecting a computer

---

1. Tap  on the Guitar Lab Screen.

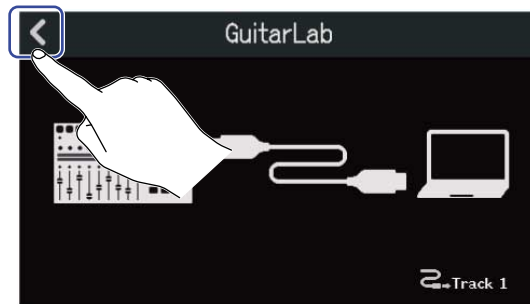

2. Tap "Execute".

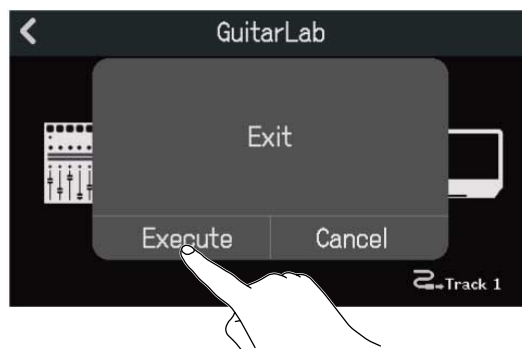

Tap "Cancel" to return to the previous screen.

3. Disconnect the USB cable connecting the R20 and the computer.

# Using MIDI keyboards

The R20 has a variety of synth sound sources. By connecting a MIDI keyboard (sold separately) to the R20, performances on it using desired sounds can be recorded.

## Connecting MIDI keyboards

1. Tap “On” for “USB MIDI keyboard” on the Project Settings Screen (→ [Opening the Project Settings Screen](#)).

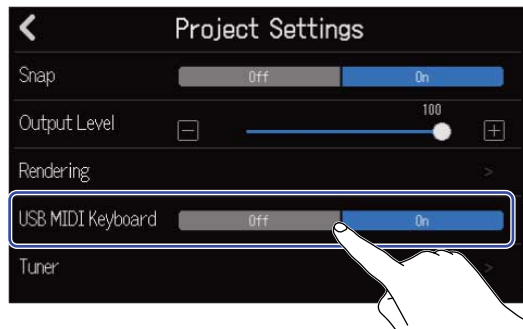

Setting	Explanation
Off	Use of a MIDI keyboard is not enabled.
On	Use of a MIDI keyboard is enabled.

2. Use a USB (Type-C) cable to connect the R20 and the MIDI keyboard. See the manual included with the MIDI keyboard for details about its settings.

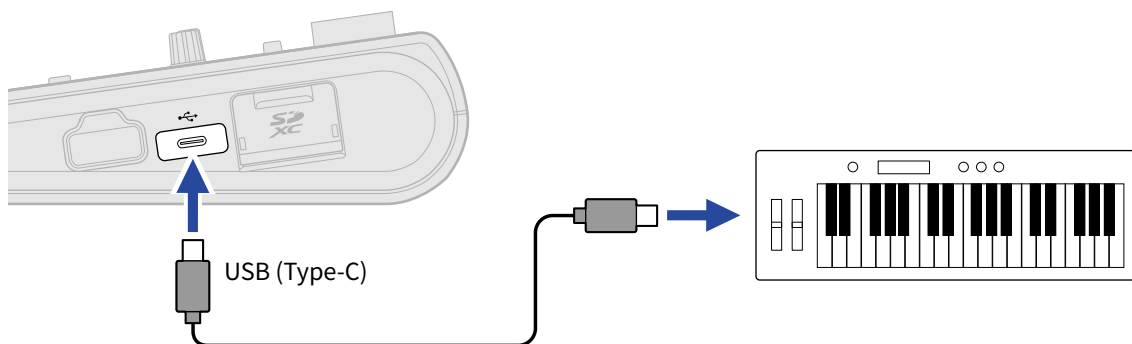

### NOTE:

The USB (Type-C) port supplies 5 V/500 mA power.

### HINT:

The MIDI keyboard setting can also be made by tapping  on the Projects Screen and tapping “On” for “USB MIDI Keyboard”. (→ [Opening a project](#))



## Disconnecting the MIDI keyboard

---

1. Tap USB MIDI Keyboard Off.

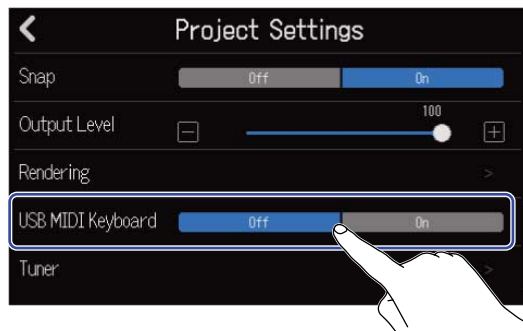

2. Disconnect the USB cable connecting the R20 and the MIDI keyboard.

# Setting the Auto Power Off function

The power will automatically turn off if the R20 is unused for 10 hours.

To keep the power on at all times, turn off the automatic power saving function.

1. Tap  on the Projects Screen (→ [Opening projects](#)).



2. Tap "On" or "Off" for "Auto Power Off".

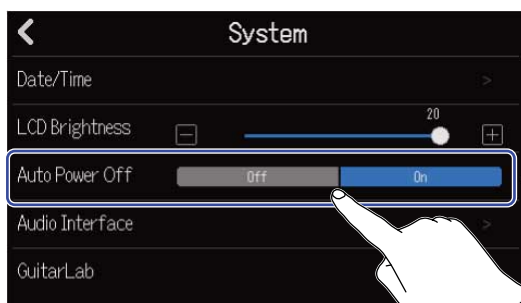

Setting	Explanation
Off	The power will not turn off automatically.
On	The power will automatically turn off if it is unused for 10 hours.

## NOTE:

Under the following conditions, the power will not turn off automatically even if set to "On".

- During playback or recording
- When using the R20 as an audio interface
- When using the R20 as a card reader

# Setting the date and time



Set the date and time added to recording files.

1. Tap  on the Projects Screen (→ [Opening projects](#)).

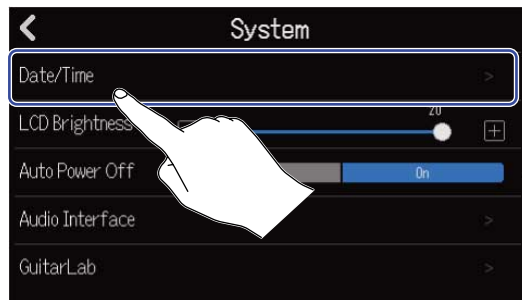

2. Tap "Date/Time".



3. Tap  /  to set the date and time.

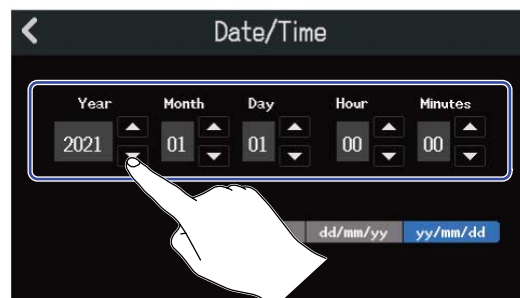

4. Tap the displayed date format to use.

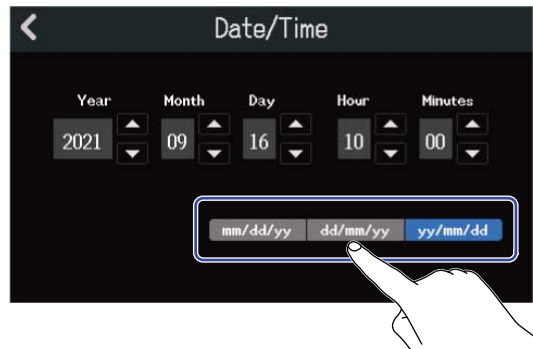

- mm/dd/yy: month/day/year
- dd/mm/yy: day/month/year
- yy/mm/dd: year/month/day

5. Tap .

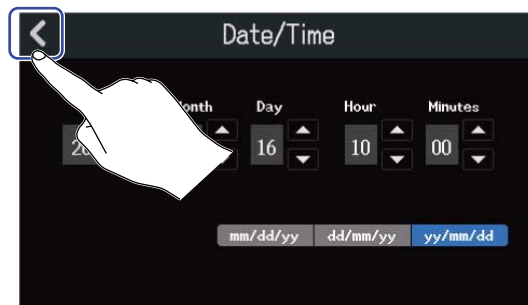

This confirms the set date and time and returns to the previous screen.

**NOTE:**

If power is not supplied by an AC adapter for a long time, date and time settings will be reset. If the date and time setting screen appears during startup, set them again.



# Adjusting the touchscreen brightness

---

The brightness of the touchscreen can be adjusted.

1. Tap  on the Projects Screen (→ [Opening projects](#)).



2. Slide the LCD Brightness slider or tap  and .

This adjusts the brightness.

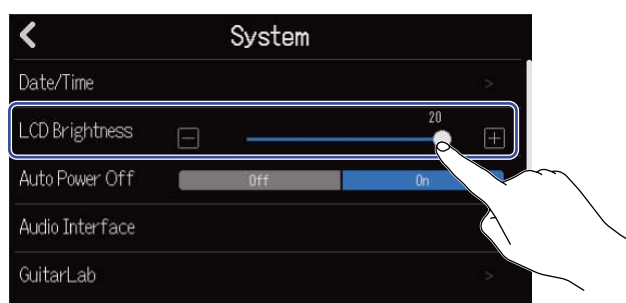

---

## HINT:

This can be set from 1 to 20.

---

# Managing SD cards

## Checking SD card information

The size and open space of SD cards can be checked.

1. Tap  on the Projects Screen (→ [Opening projects](#)).



2. Tap "SD Card".

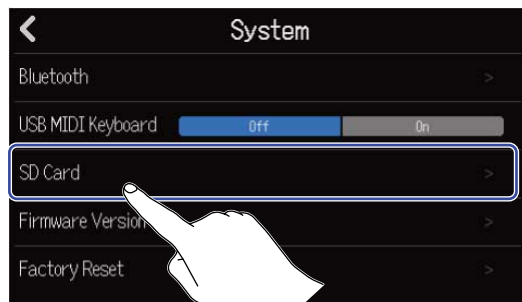

3. Check the open space and size shown by "Size".

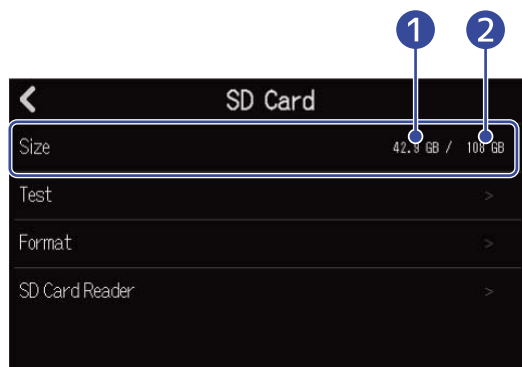

- 1 Open space
- 2 Size

# Testing SD card performance

SD cards can be tested to confirm whether they can be used with the R20. A basic test can be done quickly, while a full test examines the entire SD card.

1. Tap  on the Projects Screen (→ [Opening projects](#)).



2. Tap "SD Card".

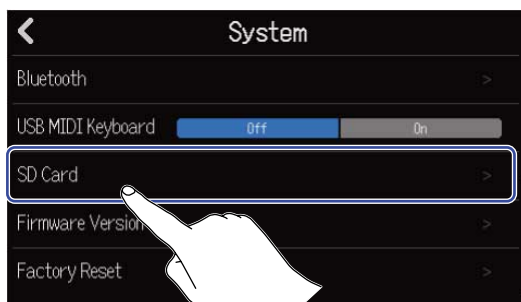

3. Tap "Test".

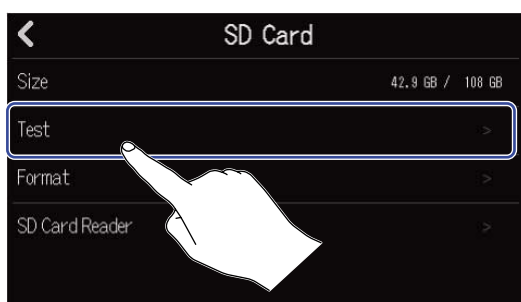

4. Tap "Quick Test" or "Full Test". Then, tap "Execute".  
The card performance test will start.

#### Quick testing

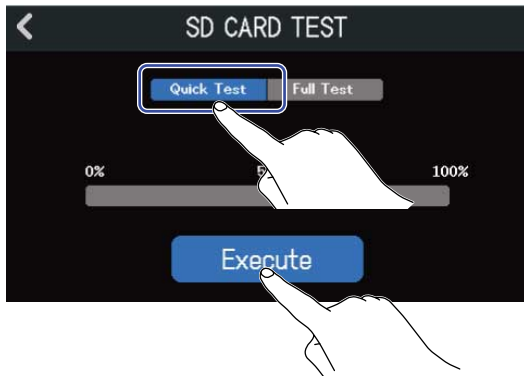

The Quick Test should take about 30 seconds.

#### Full testing

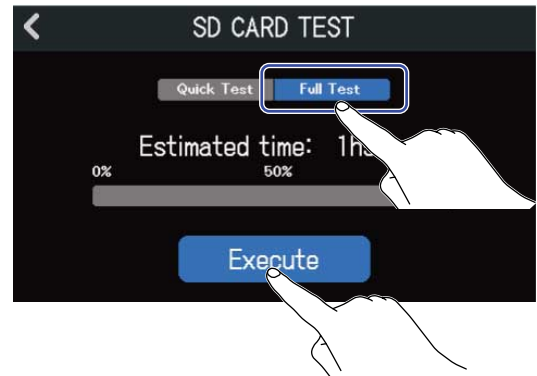

The amount of time required for the full test will be shown.

The result of the test will be shown when it completes.

During a full test, if the access rate MAX reaches 100%, the card will fail (NG).

#### NOTE:

Even if a performance test result is "OK", there is no guarantee that writing errors will not occur. This information is just to provide guidance.

#### HINT:

Tap  to cancel a test.



# Formatting SD cards

Use the R20 to format SD cards to maximize their performance.

1. Tap  on the Projects Screen (→ [Opening projects](#)).

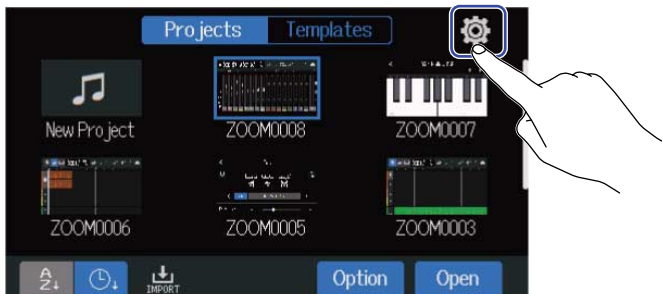

2. Tap "SD Card".

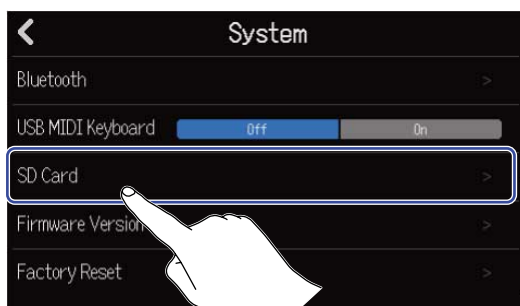

3. Tap "Format".

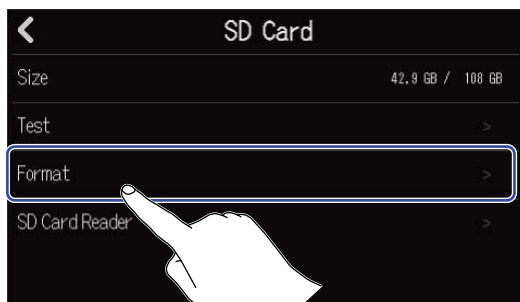

**4.** Tap “Execute”.

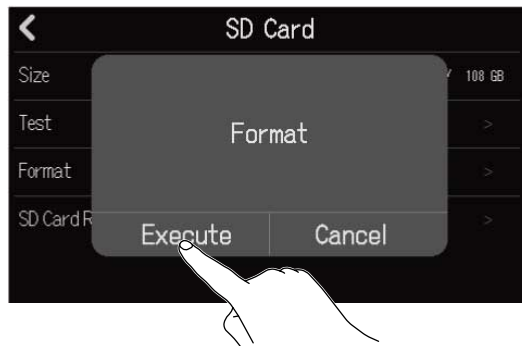

This formats the card.

Tap “Cancel” to cancel formatting.

**NOTE:**

- Before using SD cards that have just been purchased or that have been formatted on a computer, they must be formatted by the R20.
- Be aware that all data previously saved on the SD card will be deleted when it is formatted.

# Using as a card reader

By connecting with a computer, data on cards can be checked and copied.

Use this to back up projects on a computer and to load audio data and MIDI files from a computer, for example.

## Connecting to a computer

1. Tap  on the Projects Screen (→ [Opening projects](#)).



2. Tap "SD Card".

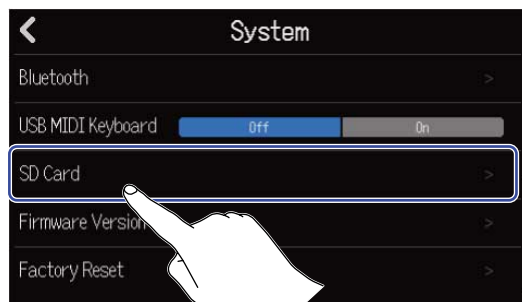

3. Tap "SD Card Reader".

This opens the SD Card Reader Screen.

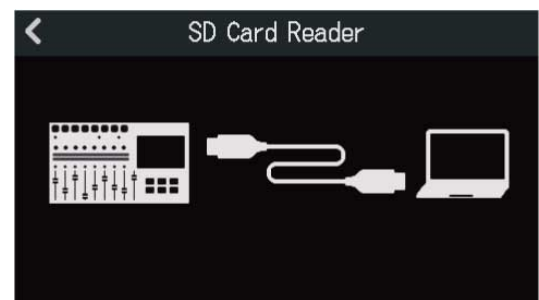
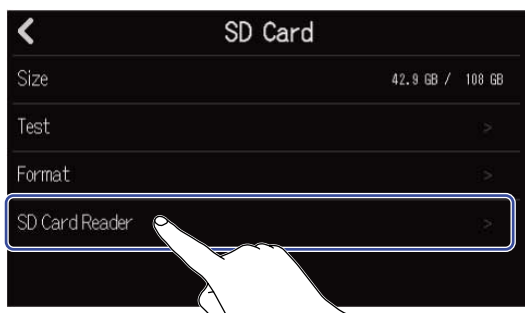

4. Use a USB (Type-C) cable to connect the R20 and the computer.

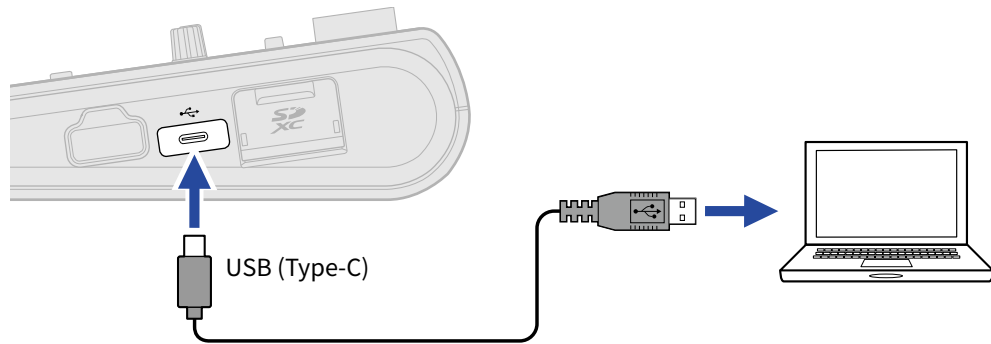

**NOTE:**

- Use a USB (Type-C) cable that supports data transfer.
- The R20 cannot operate on USB bus power.

## ■ Disconnecting from the computer

### 1. Disconnect on the computer.

From Windows:

Select the R20 with "Safely Remove Hardware".

From Mac:

Drag the R20 icon to the Trash and drop it.

#### **NOTE:**

Always conduct computer ejection procedures before disconnecting the USB cable.

### 2. Disconnect the USB cable connecting the R20 with the computer, and tap .

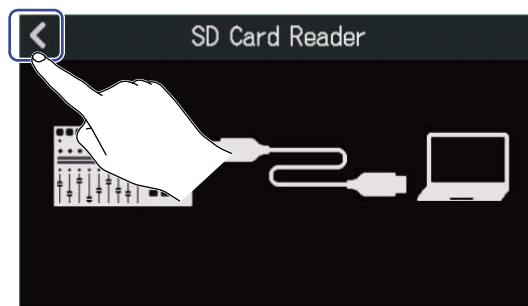

### 3. Tap "Execute".

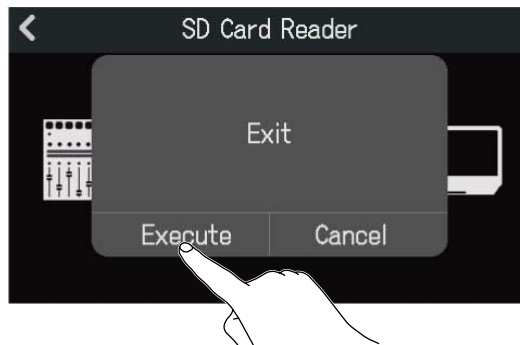

This disconnects with the computer and reopens the SD Card Screen.  
Tap "Cancel" to cancel disconnecting and return to the previous screen.

# Restoring default setting values

The R20 can be restored to its factory default settings.

1. Tap  on the Projects Screen (→ [Opening projects](#)).



2. Tap "Factory Reset".

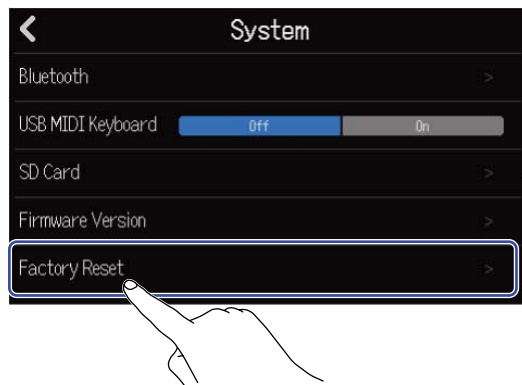

3. Tap "Execute".  
This executes the reset.

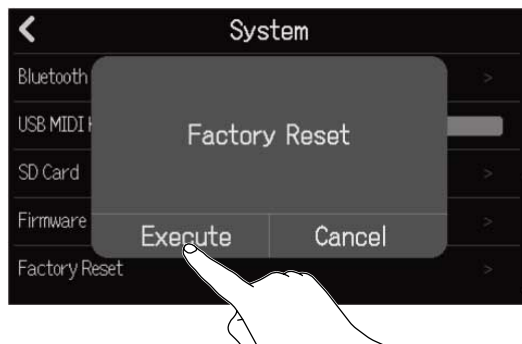

Tap "Cancel" to cancel resetting and return to the previous screen.

4. When "Please power off" appears, set  to "OFF".

**NOTE:**

- Resetting will restore all settings to their factory defaults. Be certain before using this function.
- After resetting the R20 to its factory default state, initial settings will be necessary the next time the power is turned on. (→ [Setting the date and time \(first time starting up\)](#))

# Managing the firmware

## Checking the firmware versions

1. Tap  on the Projects Screen (→ [Opening projects](#)).



2. Tap "Firmware Version".

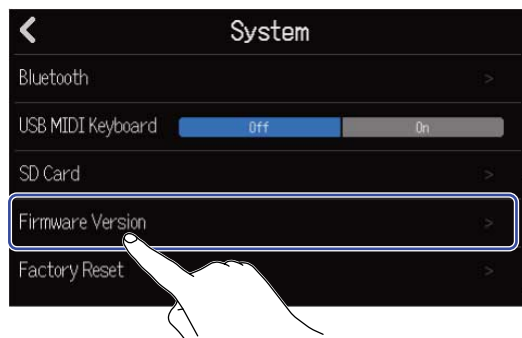

This shows the firmware and preset versions.



## Updating

The R20 firmware can be updated to the latest versions.

The latest update file can be downloaded from the ZOOM website ([zoomcorp.com](http://zoomcorp.com)).

Follow the instructions in the "R20 Firmware Update Guide" on the R20 download page.



# Appendix

---

## Troubleshooting

If you think that the R20 is operating strangely, check the following items first.

### Recording/playback trouble

---

#### There is no sound or output is very quiet

- Check the connections to the monitoring system and its volume setting.
- Confirm that the volume of the R20 is not too low (→ [Playing projects](#)).

#### Sound from connected equipment or inputs cannot be heard or is very quiet

- Check the input level settings (→ [Adjusting input levels](#)).
- If a CD player or other device is connected to an input jack, raise the output level of that device.
- Operate  knobs and faders to adjust the volume.
- Check phantom power settings (→ [Connecting input devices](#)).

#### Recording not possible

- Confirm that  is lit red.
- Confirm that the SD card has open space. (→ [Checking SD card information](#)).
- Confirm that an SD card is loaded properly in the card slot.
- If “SD card protected!” appears on the display, the SD card write-protection is enabled. Slide the lock switch on the SD card to disable write-protection.

#### Recorded sound cannot be heard or is very quiet

- Confirm that the volume levels of the tracks are not too low (→ [Playing projects](#)).
- Confirm the tracks are not muted or that another track is not soloed (→ [Muting tracks](#), [Listening to selected tracks only \(soloing\)](#)).

### Other trouble

---

#### Computer does not recognize it even though it is connected to a USB port

- Confirm that the operating system is compatible (→ [Using as an audio interface](#), [Using as a card reader](#)).
- Connection procedures must be conducted on the R20 to enable it to be recognized by a computer (→ [Using as an audio interface](#), [Using as a card reader](#)).

# Block diagram

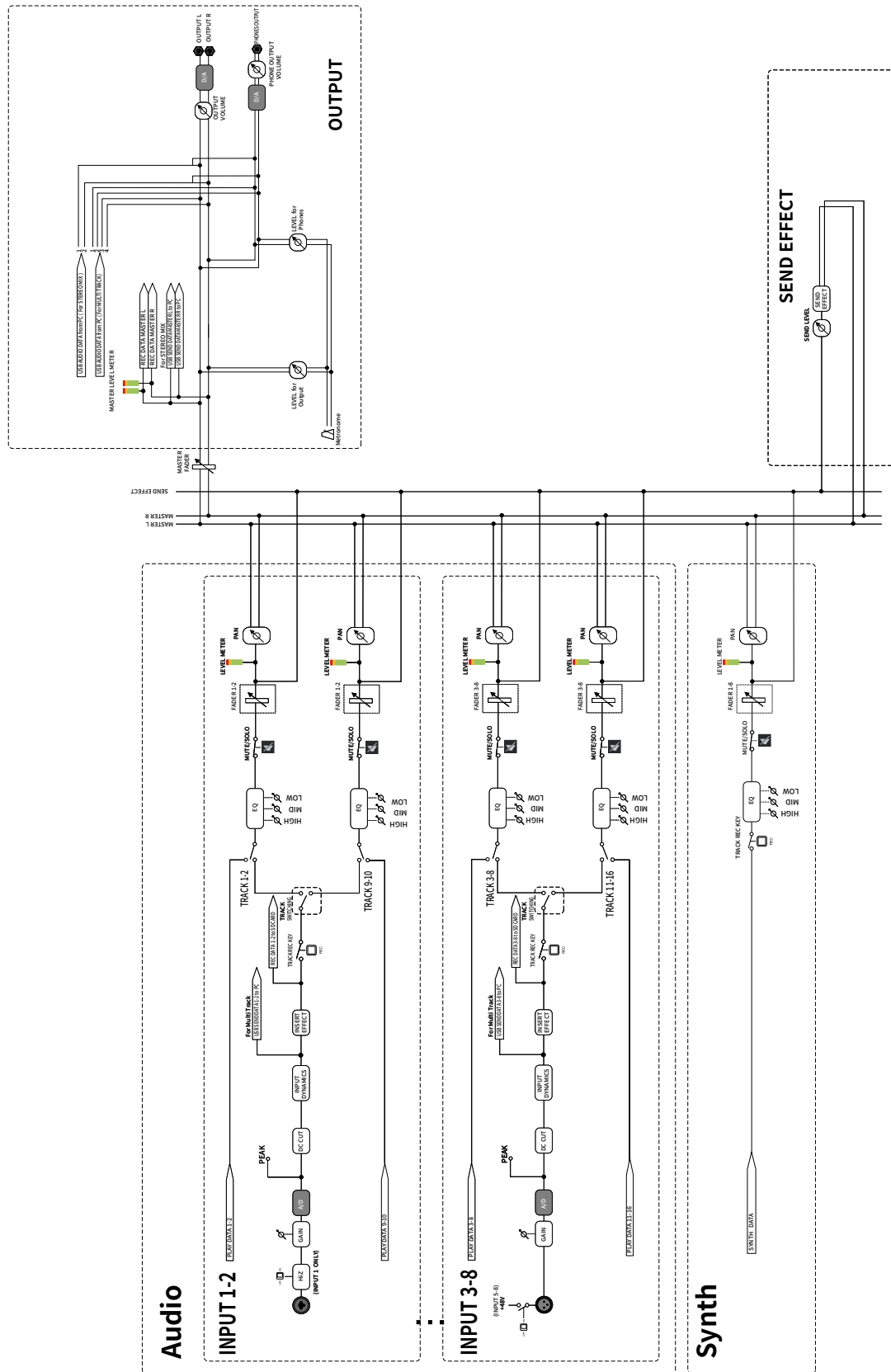

# MIDI implementation chart

[MultiTrak]

Model : R20

Date : Oct. 25, 2021

Version :1.00

Function ...		Transmitted	Recognized	Remarks
Basic Channel	Default Changed	x x	1 - 16 x	
Mode	Default Messages Altered	x x *****	Mode 1 x *****	
Note Number	True voice	x *****	0 - 127 24 - 124	C0 - E8
Velocity	Note ON Note OFF	x x	o x	
After Touch	Key's Ch's	x x	x x	
Pitch Bend		x	x	
Control Change		x	x	
Program Change	True Number	x *****	x *****	
System Exclusive		x	x	
Common	Song Position Song Select Tune Request	x x x	x x x	
System Real Time	Clock Commands	x x	x x	
Aux Messages	Local ON/OFF All Notes OFF Active Sense System Reset	x x x x	x o x x	
Notes				

Mode 1 : OMNI ON, POLY  
Mode 3 : OMNI OFF, POLY

Mode 2 : OMNI ON, MONO  
Mode 4 : OMNI OFF, MONO

o : Yes  
x : No

# Specifications

Input and output channels	Inputs	MIC/LINE (mono)	8
	Outputs	MASTER OUT	1
		PHONES	1
Inputs	MIC/LINE (mono)	Connectors	2 XLR/TRS combo jacks 6 XLR (XLR: 2 HOT/TRS: TIP HOT)
		Input gain	+6 dB – +50 dB
		Input impedance	XLR: 3.9 k $\Omega$ TRS: 5.3 k $\Omega$ /1 M $\Omega$ (when Hi-Z ON, INPUT 1 only)
		Phantom power	+48 V (INPUTS 5–8, switchable in pairs)
		Equivalent input noise	–121 dBu or less (IHF-A) at +50 dB/150 $\Omega$ input
		Frequency response	–1.0 dB: 20 Hz – 20 kHz
		Outputs	MASTER OUT
Maximum output level	+14 dBu		
Output impedance	200 $\Omega$		
PHONES	Connector		1 standard stereo phone jack
	Maximum output level		20 mW + 20 mW (into 63 $\Omega$ load)
	Output impedance		33 $\Omega$
Track settings	Pan		
	EQ		High: 10 kHz, $\pm$ 12 dB, shelving Middle: 2.5 kHz, $\pm$ 12 dB, peaking Low: 100 Hz, $\pm$ 12 dB, shelving
	Send Effect		
	Stereo Link		
	Comp/Limiter/Gate		
Recorder	Maximum simultaneous recording tracks		8
	Maximum simultaneous playback tracks		16
	Recording format		44.1 kHz, 16/24-bit, mono/stereo WAV

	Recording media	4 – 32 GB cards compatible with the SDHC specification 64 GB – 1 TB cards compatible with the SDXC specification	
Effects	Maximum number of simultaneous effects	3 types Either an insert (input) effect can be used on one channel (input) or a send effect can be used on all tracks	
	Patch memories	50	
	Guitar Lab supported		
Tuner	Chromatic/Guitar/Bass/Open A/Open D/Open E/Open G/DADGAD		
Metronome	Time signatures	3/4, 4/4, 6/8	
	Tempo range	40.0 – 250.0 BPM	
Rhythm loops	Sound source format	PCM	
	Number of loops	150	
Synth	Polyphony	8	
	Sound source format	FM	
	Number of sound types	18 (and a PCM drum kit)	
Display	4.3" (480×272) full-color touchscreen LCD		
USB	Connector	USB Type-C Note: Use a USB cable that supports data transfer. USB bus power is not supported.	
	Audio interface operation	Stereo mix	USB 2.0 Full Speed 44.1 kHz, 16/24-bit 2-in/2-out
		Multitrack	USB 2.0 High Speed 44.1 kHz, 16/24-bit 8-in/4-out
	Mass storage operation	Host/Device	USB 2.0 High Speed (5 V/500 mA power supplied when host)
	Guitar Lab connection	USB 1.1 Full Speed	
	USB MIDI keyboard connection	USB 1.1 Full Speed (5 V/500 mA power supplied)	
	DAW connection (control surface)	USB 1.1 Full Speed	

REMOTE	Dedicated wireless adapter (ZOOM BTA-1)
Power	AC adapter (ZOOM ZAD-1220): 12 V/2.0 A
Power consumption	11 W maximum
Dimensions	378 mm (W) × 206 mm (D) × 58 mm (H)
Weight (unit only)	1.33 kg

Note: 0 dBu = 0.775 Vrms



ZOOM CORPORATION

4-4-3 Kanda-surugadai, Chiyoda-ku, Tokyo 101-0062 Japan

[zoomcorp.com](https://zoomcorp.com)