



## LIGHT BOX 6090

### Product Manual

English

### Foreword

Thank you for purchasing Aputure Light box 6090.

Light box 6090 is designed for LS 120d II,LS 300d II,LS 300X,LS 600d Pro,Amaran 60,Amaran 100 and Amaran 200 series and compatible with other Bowens Mount LED video light.

### IMPORTANT SAFETY INSTRUCTIONS

When using this unit, basic safety precautions should always be followed, including the following:

1. Read and understand all instructions before using.
  2. Close supervision is necessary when any fixture is used by or near children. Do not leave the fixture unattended while in use.
  3. Care must be taken as burns can occur from touching hot surfaces.
  4. Care must be taken when touching, installing or disassembling the elastic support rod.
  5. Let the fixture cool completely before storing.
  6. To reduce the risk of injury, please install or disassemble the fixture properly.
  7. The use of an accessory attachment not recommended by the manufacturer may increase the risk of fire, electric shock, or injury to any persons operating the fixture.
  8. Please do not place the fixture near any liquids or other flammable objects.
  9. Only use a dry microfiber cloth to clean the product.
  10. This product is certified by RoHS. Please operate the product in full compliance with the operation standards.
- Please note that this warranty does not apply to repairs arising from malfunctions, although you may request such repairs on a chargeable basis.

11. The instructions and information in this manual are based on thorough, controlled company testing procedures. Further notice will not be given if the design or specifications change.

### SAVE THESE INSTRUCTIONS

#### Check list

When you unbox the product, please make sure all the items listed below are included. Otherwise, please contact the seller immediately.



60\*90 Square softbox (1pc)

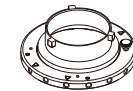

Speed Ring Adapter (1pc)



Inside Fabric Diffusion (1pc)



Front Fabric Diffusion (1pc 1.5 Stop Diffusion, 1pc 2.5 Stop Diffusion)

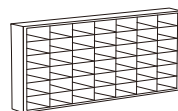

Fabric Light Control Grid (1pc)



Light Box 6090 Carrying Bag (1pc)

### Installations

According to the diagonal installation method, insert the four support rods, then lock the chuck, and fit the velcro on the softbox, then install the softbox on the lamp.

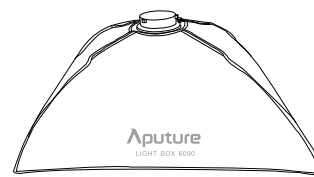
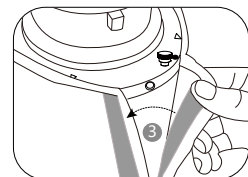
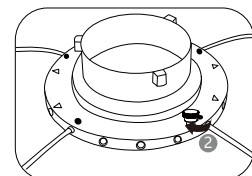
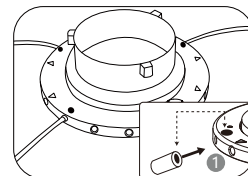

Use Velcro to install the Fabric Light Control Grid on the diffuser.

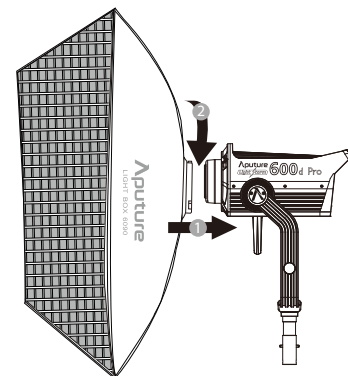

Disassembly: Pull out four steel rods diagonally and in the opposite direction

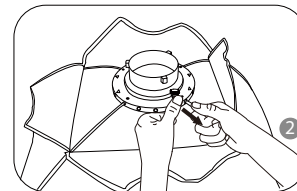
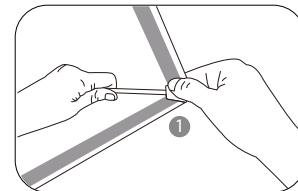

### Specifications

Item	Dimension	Net Weight
softbox(built)	60*90*53 cm/23.62*35.43*20.86in	1215g
softbox(Collapsed)	67*10*3cm/26.38*3.94*1.18in	
Front Fabric Diffuser 1(1.5 stop)	60*90cm/23.62*35.43in	
Front Fabric Diffuser 2(2.5 stop)	60*90cm/23.62*35.43in	
Inside Fabric Diffusion	35*29cm/13.7*11.4in	
Fabric Light Control Grid	60*90cm/23.62*35.43in	
Speed Ring Adapter	Standard Bowens Mount	

### Trademarks

Bowens is a trademark registered by Bowens in China and other countries.

Detailed product manual can be found on [www.aputure.com](http://www.aputure.com).

Aputure Imaging Industries Co., Ltd.

Aputure®  
Inspection: Qualified

Aputure®

Aputure Imaging Industries Co., Ltd.

Inspection: Qualified

Serial No.	
Item Name	
Purchase Date	
Buyer Name	
Buyer Phone	
Buyer Add	
Franchiser Seal	

Aputure Imaging Industries Co., Ltd.  
Add: F/3, Building 21, Longjun Industrial Estate, Heping West Road, Shenzhen, Guangdong

Aputure Imaging Industries Co., Ltd.  
Add: F/3, Building 21, Longjun Industrial estate, Heping West Road, Shenzhen, Guangdong  
E-MAIL: [cs@aputure.com](mailto:cs@aputure.com)  
Sales Contact: (86)0755-83235569-613

**This warranty is void if:**

- The product identification or serial No. label is removed or defaced in any way.
- The product is serviced or repaired by any one other than Aputure or an authorized Aputure dealer or service agency.

**Aputure Imaging Industries Co., Ltd. warrants the original consumer purchaser from defects in material and workmanship for a period of one (1) Year after the date of purchase.** For more details of warranty visit [www.aputure.com](http://www.aputure.com)

**Important:** Keep your original sales receipt. Be sure the dealer has written on it the date, serial No. of the product. This information is required for warranty service.

**This warranty does not cover:**

- Damage that is the result of misuse, abuse, accident (including but not limited to damage by water), faulty connection, defective or maladjusted associated equipment, or the use of the product with equipment for which it was not intended.
- Cosmetic defects that appear more than thirty (30) days after the date of purchase. Cosmetic damage caused by improper handling is also excluded.
- Damage that occurs while the product is being shipped to whoever will service it.

Aputure®  
GUARANTEE CARD

Service Warranty (EN)

Aputure Imaging Industries Co., Ltd. warrants the original consumer purchaser from defects in material and workmanship for a period of one (1) Year after the date of purchase. For more details of warranty visit [www.aputure.com](http://www.aputure.com)



## LIGHT BOX 6090

爱图仕方形柔光箱60\*90cm

## 使用者指南

中文

## 前言

感谢您购买爱图仕Light Box 6090柔光箱。

Light Box 6090柔光箱是一款可以搭配爱图仕LS 120d II, LS 300d II, LS 300X, LS 600d Pro, 爱蒙拉60, 爱蒙拉100以及爱蒙拉200系列摄影灯使用的柔光箱, 并且可以兼容其他品牌宝荣卡口影视灯具。

## 重要的安全说明

使用此摄影灯时, 应始终遵循基本的安全预防措施, 包括:

1. 使用前阅读并理解所有说明。
2. 当儿童靠近设备或使用设备时, 必须进行密切监督。在使用设备时, 请勿将设备置于无人看管状态。
3. 必须小心接触高温部件防止被烫伤。
4. 必须小心接触和拆装弹性支撑杆。
5. 在存放前让设备完全冷却, 待冷却后归置在手提包对应位置。
6. 为降低伤害风险, 请正确拆装本产品, 在需要维修时将其交给合格的维修人员。不正确的拆装可能会引起本产品的损坏。
7. 使用非制造商推荐的配件可能会引起火灾、电击或人身伤害。
8. 勿将本产品置于液体或其他易燃, 易挥发溶剂附近, 避免损坏产品。
9. 请用软布、干布清洁本设备。
10. 本产品已通过RoHS认证, 请参考相关国家标准使用和操作。  
因使用操作不当而造成产品损坏, 不在保修范围内, 但用户可以付费维修。
11. 此使用者指南依据本公司严格测试制定。设计和规格如有变更, 恕不另行通知。

## 保存这些说明

## 物品清单

使用本产品前, 请检查包装内是否包含所有以下物品。  
如有缺失, 请与经销商联系。



柔光箱 (1pc)



卡盘 (1pc)



内部柔光布 (1pc)



外部柔光布  
(1.5 stop \* 1pc, 2.5 stop \* 1pc)

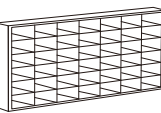

格栅 (1pc)



手提包 (1pc)

## 安装

以沿着卡盘底座直径方向、对向的顺序, 依次插入四根支撑杆, 然后锁紧卡盘, 贴好柔光罩上的魔术贴后, 将柔光罩装上灯具。

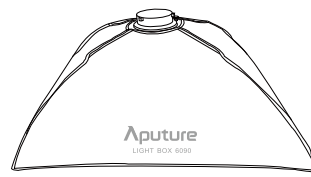
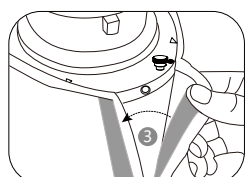
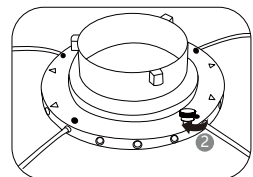
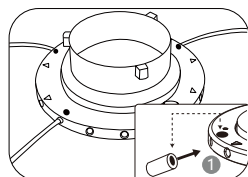

用魔术贴将格栅安装在柔光罩上

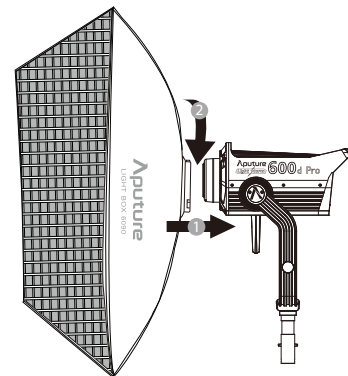

## 拆卸

拆卸: 以沿着卡盘底座直径方向、对向的顺序, 反方向拔出四根钢丝。

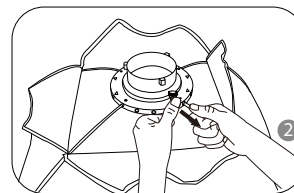
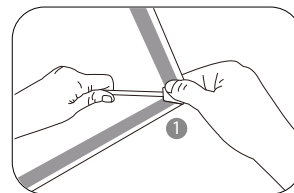

## 规格

名称	尺寸	重量
柔光箱(展开)	60*90*53 cm	1215g
柔光箱(收纳)	67*10*3 cm	
柔光布 1(1.5档)	60*90cm	
柔光布 2(2.5档)	60*90cm	
内层柔光布	35*29cm	
格栅	60*90cm	
卡口	标准宝荣卡口	

## 商标声明

Bowens是保荣公司在中国或其他国家的商标及产品型号。

您可以在本公司网站 [www.aputure.cn](http://www.aputure.cn) 中找到本设备的详细使用者指南。

深圳市爱图仕影像器材有限公司  
检验:合格

深圳市爱图仕影像器材有限公司  
地址:广东省深圳市龙华和平西路九窝龙军工业区21栋3楼  
邮编:518108  
邮箱:tc@aputure.com  
销售热线:0755-89285599-613  
服务热线:400-0999-028

产品编号	产品名称	购买日期	用户姓名	用户电话	用户地址	经销商印章

**重要说明:**  
请保留您原始购买单据及保修卡, 确定您购买的供应商资料都在此单据, 同时包括您的购买日期, 产品序列号等, 这些资料质保服务时都会需要提供。

**质保范围不包括:**

- 产品不当使用、破坏、意外、错误接线、不良或失调的外接装置, 不适合的外接装置所造成的损坏(包括暴露于雨水等损坏), 不在质保范围。
- 自购买日30天后产品外观的损坏, 或是不当的表面处理接触造成的外观损伤, 不在质保范围。
- 经销商运送所造成的损坏, 不在质保范围。

**质保无效说明:**

- 产品序列号标识已经被撕去或无法辨识, 本质质保无效。
- 产品未经本公司或者指定授权维修公司的检修及改装, 本质质保无效。

保修条款(中文)  
本公司对产品第一买家客户提供为期一年的质量保证期。质保内容和细节, 请登陆我们的网站[www.aputure.cn](http://www.aputure.cn)。

Aputure® 保修卡