

Canon

RF-S

3.9mm F3.5 STM DUAL FISHEYE

Instructions

ENG

Thank you for purchasing a Canon product.

The Canon RF-S3.9mm F3.5 STM DUAL FISHEYE is a VR image production lens for use with EOS R series cameras compatible with RF-S lenses.

- To get the most from your lens, we recommend using it under the following conditions.
 - Use Live View
 - Use a tripod
- Images can be captured with two lenses, left and right. These images can be converted to a VR image using a camera application that supports the captured images.
- “STM” stands for Stepping Motor.

Conventions used in these instructions



Warning to prevent lens or camera malfunction or damage.



Supplementary notes on using the lens and taking pictures.

Camera Firmware and Camera Applications

Please use the latest versions of firmware and applications with the camera in use. For details on whether the firmware and applications in use are the latest version or not, and for details on updating them, please check the Canon website.



This lens can be used with some cameras* in the EOS R series. If the camera does not support it, or the camera's firmware is not a compatible version, there may be issues with the camera operation.

* For supported cameras, please check the Canon website.

Safety Precautions

Precautions to ensure that the camera is used safely. Read these precautions thoroughly. Make sure all details are observed in order to prevent risks and injury to the user and other people.

Be sure to follow the instructions carefully when using the lens.



Warning

Details pertaining to risks that may result in death or serious injury.

- **Do not look directly at the sun or other strong light sources through a lens.** This may result in loss of sight.
- **Do not leave a lens in the sun without the lens cap attached.** The lens may concentrate entering sunlight and cause a malfunction or fire.



Caution

Details pertaining to risks that may result in injury or damage to other objects.

- **Do not leave the product in places exposed to extremely high or low temperatures.** The product may cause burns or injury when touched.
- **Do not shoot movies with extreme movement.** Viewing such movies may result in motion sickness-like symptoms.
- **Avoid shaking while shooting.** Viewing VR images taken while riding a vehicle or walking may result in feelings of fatigue or discomfort. When shooting such images, use of a tripod is recommended. Use the tripod to create a level view before shooting.

Safety Precautions

Be sure to follow the instructions carefully when viewing VR images.



Warning

Details pertaining to risks that may result in death or serious injury.

- **Those with an eye or heart condition or high blood pressure, pregnant women, and those with a history of spine disorders should consult with a doctor before viewing.** Viewing such images may cause symptoms to worsen.
- **Some individuals may experience muscle spasms, loss of consciousness, seizures, or other such symptoms while being subjected to stimuli such as bright lights or repeatedly blinking images. If you have ever experienced these sorts of problems, be sure to consult with a doctor before viewing.** Viewing such images may cause symptoms to worsen.
- **Extended continuous viewing the images by a person who has not yet finished developing may adversely affect the eyes or body.** Please pay attention to user's condition when viewing by anyone age 15 or younger. If you notice that the person has an abnormal physical condition, immediately stop using this device and see a doctor. Please use this device continuously for no longer than 3 minutes.



Caution

Details pertaining to risks that may result in injury or damage to other objects.

- **Those who cannot see the images clearly should refrain from viewing.** This may adversely affect the eyes or body.
- **Viewing the images by those who are unwell is not recommended.** This may cause feelings of nausea.
- **Those who are susceptible to motion sickness should consult with a doctor before viewing.** Viewing may cause the same symptoms to occur.
- **Do not view continuously for more than 30 minutes and allow your eyes and body to rest periodically.** Extended continuous viewing may adversely affect the eyes or body.
- **If you start to feel fatigued, discomfort, or any abnormality while viewing, discontinue viewing.** Continued viewing may affect your health.
- **Do not view images with either left or right display blocked, or while otherwise viewing drastically different images in left and right sides.** This may have a negative effect on the eyes or body.

General Precautions

Handling Precautions

- Do not leave the product in excessive heat such as in a car in direct sunlight. High temperatures can cause the product to malfunction.
- If the lens is taken from a cold environment into a warm one, condensation may develop on the lens surface and internal parts. To prevent condensation in this case, first put the lens into an airtight plastic bag before taking it from a cold to warm environment. Then take out the lens after it has warmed gradually. Do the same when taking the lens from a warm environment into a cold one.
- Please also read any lens related handling precautions listed in your camera's instruction manual.

Shooting Precautions

- Focus again after recovering from the auto power off status.
- To maintain the focus position in the shooting-ready status, set [Auto power off] to [Disable] on the camera.
- This lens has a short focal length, which means dirt or dust on the surface of the lens will show up easily.
Use a commercially-available blower to remove dirt or dust from the lens surface or mount opening.
- This lens is comprised of two lenses, and both the left and right lenses are read by one sensor. Depending on the camera, the image of the left lens is displayed on right side of the monitor, and the image of the right lens is displayed on the left side of the monitor.
Please refer to the camera's instructions for details.

This device complies with Part 15 of the FCC Rules.

Operation is subject to the following two conditions: (1) This device may not cause harmful interference, and (2) this device must accept any interference received, including interference that may cause undesired operation.

Do not make any changes or modifications to the equipment unless otherwise specified in the instructions. If such changes or modifications should be made, you could be required to stop operation of the equipment.

This equipment has been tested and found to comply with the limits for a class B digital device, pursuant to part 15 of the FCC Rules. These limits are designed to provide reasonable protection against harmful interference in a residential installation. This equipment generates, uses and can radiate radio frequency energy and, if not installed and used in accordance with the instructions, may cause harmful interference to radio communications.

However, there is no guarantee that interference will not occur in a particular installation. If this equipment does cause harmful interference to radio or television reception, which can be determined by turning the equipment off and on, the user is encouraged to try to correct the interference by one or more of the following measures:

- Reorient or relocate the receiving antenna.
- Increase the separation between the equipment and receiver.
- Connect the equipment into an outlet on a circuit different from that to which the receiver is connected.
- Consult the dealer or an experienced radio/TV technician for help.

Nomenclature

Left lens (→ 11) ————— Right lens (→ 11)

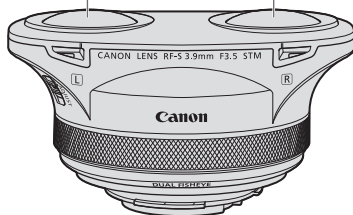

Focusing/Control ring (→ 9)

Lens cap mount (→ 8)

Left-right focus difference adjustment mode switch (→ 12)

Lens mount index (→ 7)

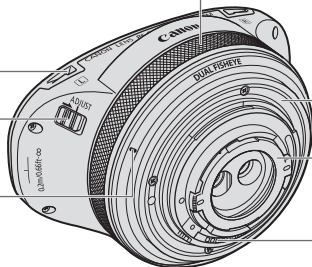

Lens mount (→ 7)

Rear filter holder (→ 14)

Contacts (→ 7)

- For detailed information, reference page numbers are provided in parentheses (→ **).

1. Attaching and Detaching the Lens

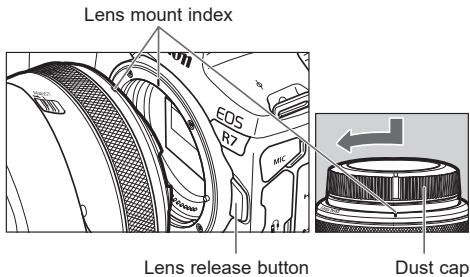

- Set the camera's power switch to OFF when attaching or detaching the lens.
- Attach the lens cap before detaching the lens from the camera.
- After detaching the lens, place the lens with the rear end up and attach the dust cap to prevent the lens surface and contacts from getting scratched. Make sure the lens and dust cap mount indexes are aligned when attaching the dust cap.
- Contacts that are scratched, soiled, or have fingerprints on them may result in faulty connections or corrosion, which may lead to malfunctions. If the contacts get soiled, clean them with a soft cloth.

Attaching the Lens

Align the lens mount indexes of the lens and camera, and turn the lens clockwise until you hear a click.

Detaching the Lens

Turn the lens counterclockwise while pressing the camera's lens release button. Detach the lens once it has stopped turning.

Please refer to the camera's instructions for details.

2. Attaching and Detaching the Lens Cap

This lens projects out past the front frame. To protect the lens, use the special lens cap when not taking photos.

Attaching the Lens Cap

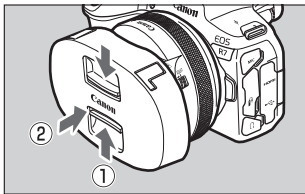

Attach (2) while squeezing the levers (1) on the inner sides of the cap.

Detaching the Lens Cap

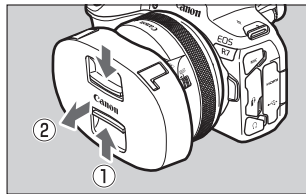

Detach (2) while squeezing the levers (1) on the inner sides of the cap.



- After detaching the lens cap, do not touch the lens surface or allow it to come into contact with its surroundings.

3. Focusing/Control ring

The focusing/control ring can be used as either a focusing ring or a control ring.

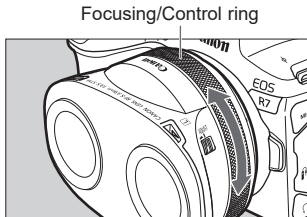

Switching between the focusing ring and control ring is performed on the camera. Please refer to the camera's instructions for details.

Use as a Focusing Ring

Set the focus mode (AF/MF) on the camera.

To shoot in autofocus (AF) mode, set the camera's focus mode to [AF].

To use only manual focusing (MF), set the camera's focus mode to [MF], and focus by turning the focusing ring (focusing/control ring).

Use as a Control Ring

Set the control ring function using the camera's menu. The control ring can be assigned the functions that are commonly used with cameras, such as shutter speed and aperture settings. Please refer to the camera's instructions for details on how to use the control ring.

Focusing/Control ring



- The lens does not have a focus mode switch or a focusing/control selector switch.
- Delayed focus may occur if the focusing ring (focusing/control ring) is quickly turned.
- Adjust for any difference in focus between the left and right lenses. For details, see 4. Checking/Adjusting Left and Right Focus.
- This lens does not support Servo AF. Before movie recording, set the focus using One-Shot AF or manual focus.



- This lens' focusing/control ring is electronic.
- It is possible to set cameras that support electronic fulltime manual focusing to manual focusing when the camera is in the operational mode. However, the camera settings need to be changed.
- When AF operation is set to One-Shot AF, manual focus is possible after autofocus has been completed by continuing to press the shutter button halfway (electronic manual focus function). However, the camera settings need to be changed.
- During movie mode, the AF speed will be slower than in still image shooting mode.

Please refer to the camera's instructions for details.

4. Checking/adjusting left and right focus

Checking Left and Right Focus

When first mounting this lens on the camera, or when using it after being transported for an extended period, use the following steps to check the difference between left and right focus.

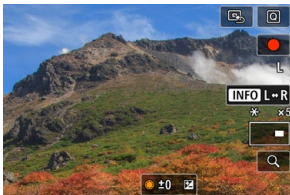

- 1 Display an enlarged image from the left lens, then either use the camera's autofocus (AF) or turn the focusing ring (focusing/control ring) to focus the lens.

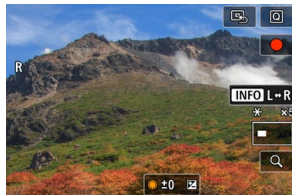

- 2 Switch to an enlarged image from the right lens.
 - If the focus in the enlarged image from the right lens is correct after switching, adjustment is not needed. Only adjust the focus, using the steps on the following page, if the focus is not correct.



- For information on how to display an enlarged image from the left lens and how to switch display of enlarged images between the left and right lenses, refer to the "Shooting and Recording/Focusing" section in the VR Recording Guide.

Checking/adjusting left and right focus

Adjusting left and right focus

Leaving the enlarged image from the right lens showing, adjust using the following steps.

Left-right focus difference adjustment mode switch

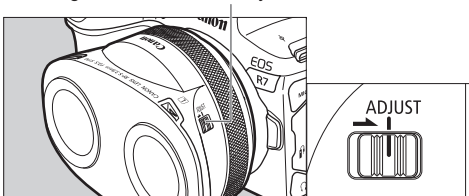

Focusing/Control ring

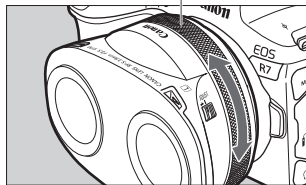

1 Slide the left-right focus difference adjustment mode switch to the ADJUST side.

2 Turn the focusing/control ring to adjust.

- Turning the focusing/control ring only adjusts the focus of the right lens.
- Adjustment is complete once the focus in the enlarged image from the right lens is correct.
- After adjustment, return the left-right focus difference adjustment mode switch back to its original position (the opposite side to ADJUST).

Checking/adjusting left and right focus

- If the right lens focus goes notably out of range while correcting for focus differences in the left and right lenses, slide the left-right focus difference adjustment mode switch back and forth three times within 6 seconds, starting from the ADJUST side. This will reset the right lens position to its initial setting. After that, check and adjust the left and right focus again.
- When the left-right focus difference adjustment mode switch is set to the ADJUST side, the AF mode cannot be used. In addition, you cannot shoot still images and movies.

5. Filters (Sold separately)

This lens has a rear filter holder at the rear.

It can take screw-in filters ($\phi 30.5\text{mm}$) or sheet filters (gelatin filters).

When using screw-in filters:

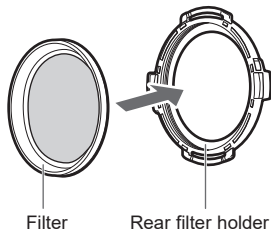

1 Attach the filter ($\phi 30.5\text{mm}$) to the rear filter holder mounting thread.

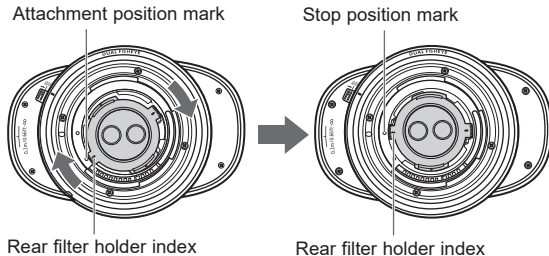

2 Match up the rear filter holder index and the attachment position mark on the lens, and turn the rear filter holder clockwise until it reaches the stop position mark.

- Removal is the reverse of attaching.



- Only one filter may be used.
- Please note that some filters cannot be attached, depending on their thickness or shape. If you force the filter on, you could damage the lens or filter.

Filters (Sold separately)

When using sheet filters (gelatin filters):

Download the filter template files, print them out, then lay the filter over the template and cut to match. Then insert the filter in the rear filter holder.

1 Cut the filter to match the filter template outline.

- Download the filter template file (PDF).
- Print the filter template out at full size (100%), and use it as the template to cut out the filter.
- Also print this page out at full size and use it as the template. The filter template file is the same as this figure.

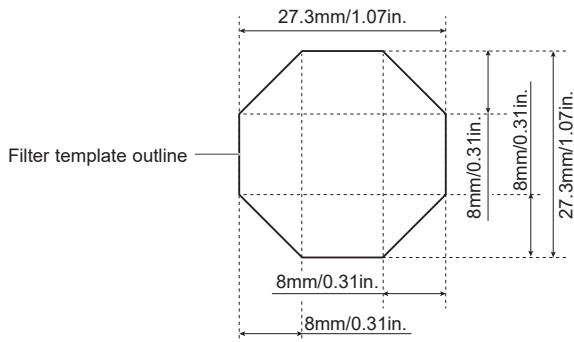

Filters (Sold separately)

- Only one filter with a thickness of 0.2 mm/0.008 in. or less may be used.
- When printing the template, make sure that the illustration size remains the same. Check that the printed-out size is the same as the measurements shown in the illustration.
- Cut along the middle of the lines printed on the filter template. Any deviation from the template line width can cause the following issues.

Note 1: Cutting inside the line can lead to the filter not being held securely in the rear filter holder and slipping out of place.

Note 2: Cutting outside the line can lead to the filter not fitting in the rear filter holder.

Filters (Sold separately)

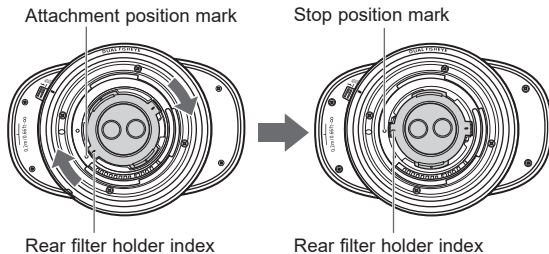
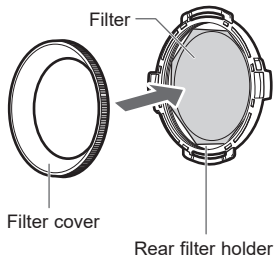

2 After attaching the filter to the rear filter holder, attach the filter cover to the rear filter holder mounting thread.

3 Match up the rear filter holder index and the attachment position mark on the lens, and turn the rear filter holder clockwise until it reaches the stop position mark.

- Removal is the reverse of attaching.

! ● Image ghosting may occur as a result of using a filter. Take care to avoid getting dirt or scratches on the filter.

6. Exposure

Photographing with AE (auto exposure) is possible at all focusing distances even with this lens attached.

- AE metering range is restricted to within the image circle in the left lens.
- As this lens is wide-angle, using flash photography on close-up subjects can cause very inaccurate AE exposure measurements. In that case, either use a separate light meter or check your images after capture.

Specifications

Focal Length/Aperture	3.9mm f/3.5
Lens Construction	8 groups, 11 elements (2 prisms) (per optical system)
Maximum Aperture	f/3.5
Minimum Aperture	f/16
Angle of View	Horizontal: 144°, Vertical: 144°, Diagonal: 144°
Min. Focusing Distance	0.2 m/0.66 ft.
Max. Magnification	0.03x
Baseline Length (Central point between left and right lenses)	Approx. 60 mm/2.36 in.
Width x Height x Length	Approx. 112 mm x 83.7 mm x 54.6 mm/4.41 x 3.30 x 2.15 in.
Weight	Approx. 290 g/10.23 oz. (without the rear filter holder attached)
Lens Cap	Lens Cap 3.9*
Lens Dust Cap	Lens Dust Cap RF*
Case	LS1014 (Sold separately)

* This comes included with the lens, but can also be purchased separately.

Specifications

- The lens length is measured from the lens mount surface to the front end of the lens.
Add 24.2 mm/0.95 in. when including the lens cap and dust cap.
- The width, height, length and weight are for the lens itself only.
- Close-up Lens 250D/500D cannot be attached because there is no size that fits the lens.
- You cannot use extenders.
- All data listed is measured according to Canon standards.
- Product specifications and appearance are subject to change without notice.

Canon