



Hollyland Solidcom C1 Pro Hub

User Manual

V2.0

Interfaces

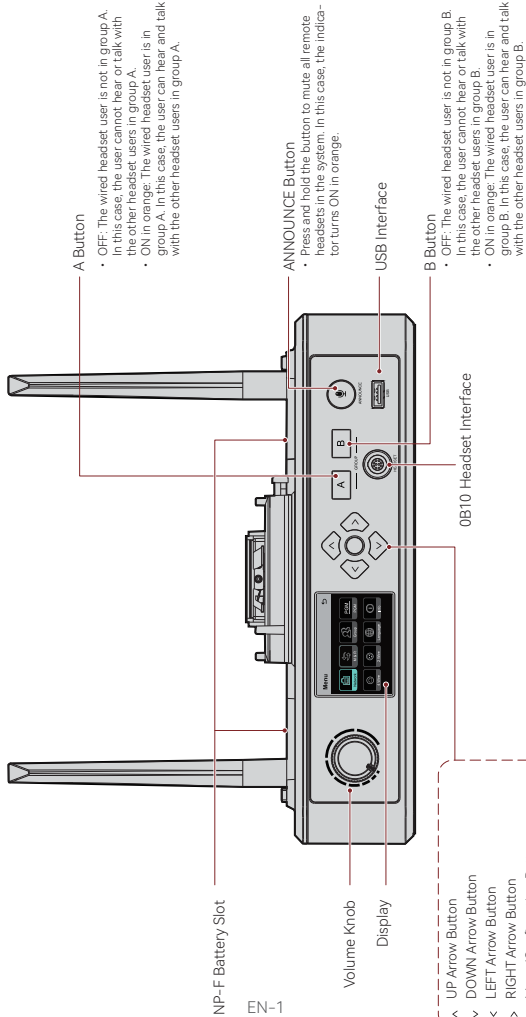

Interfaces

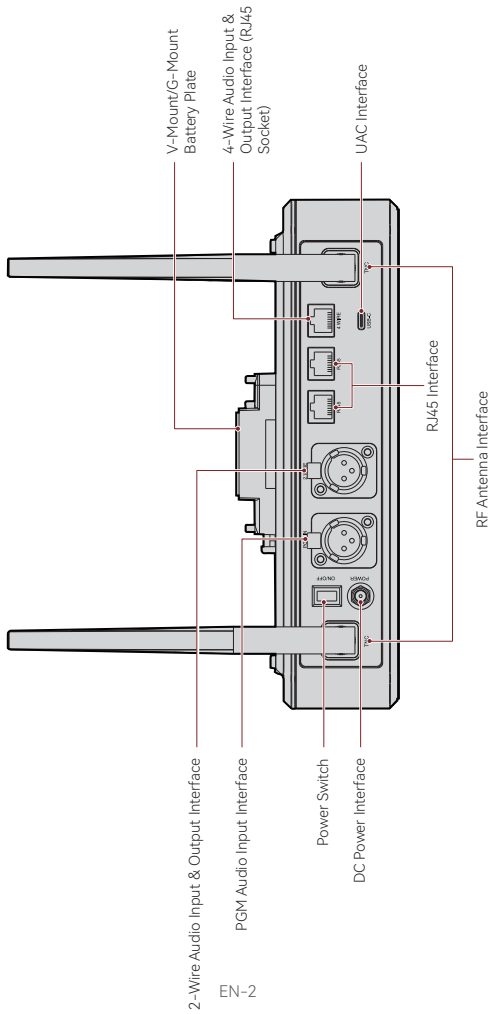

0B10 Wired Headset Interface

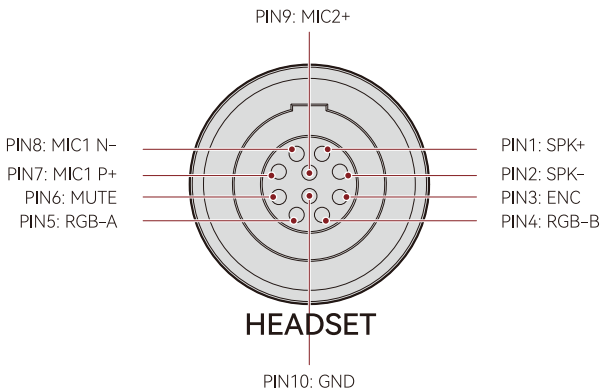

4-Wire Audio Input & Output Interface

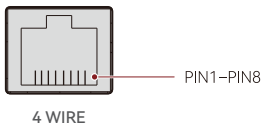

Standard Line Sequence			
PIN1	GND	PIN5	AUDIO OUT-
PIN2	GND	PIN6	AUDIO IN-
PIN3	AUDIO IN+	PIN7	GND
PIN4	AUDIO OUT+	PIN8	GND

Cross Line Sequence			
PIN1	GND	PIN5	AUDIO IN-
PIN2	GND	PIN6	AUDIO OUT-
PIN3	AUDIO OUT+	PIN7	GND
PIN4	AUDIO IN+	PIN8	GND

2-Wire Audio Input & Output Interface

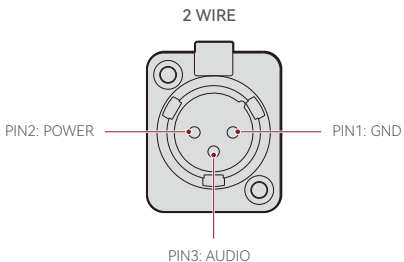

PGM Audio Input Interface

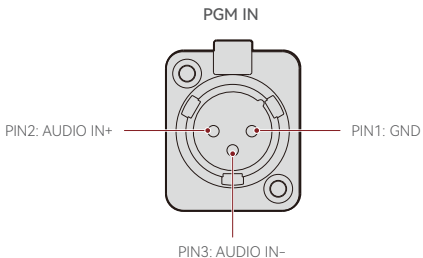

RJ451/RJ452 Interface

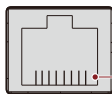

RJ45

PIN1-PIN8

Standard Line Sequence			
PIN1	Transceive Data+	PIN5	Not connected
PIN2	Transceive Data-	PIN6	Receive Data-
PIN3	Receive Data+	PIN7	Not connected
PIN4	Not connected	PIN8	Not connected

Operation Guide

Hub Display Description

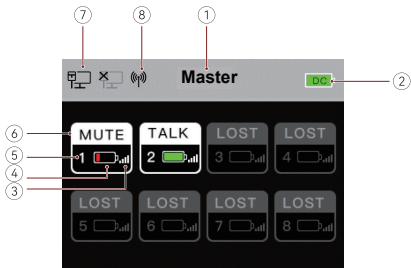

- ① Hub Mode (Master/Remote)
- ② Hub Battery Level
- ③ Headset Signal Strength
- ④ Headset Battery Level (Red: Low Battery)
- ⑤ Headset Number
- ⑥ Headset Status

TALK: The headset user can hear and talk with the other headset users.

MUTE: The headset user is muted and can only hear the other headset users.

LOST: The headset is disconnected from the hub.

LINK: The headset is reconnecting to the hub.

- ⑦ Network Connection Status
- ⑧ Wi-Fi Status

Operation Guide

Hub Menu Description

Press and hold the Menu/Confirmation button for about 3 seconds to enter the menu interface.

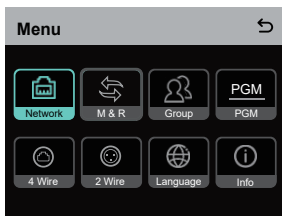

1. Select **Network** to enter the network configuration interface.
- 1.1 Select **Wifi Setting** to turn Wi-Fi ON or OFF. After it is turned ON, the IP address, SSID, and password are displayed.

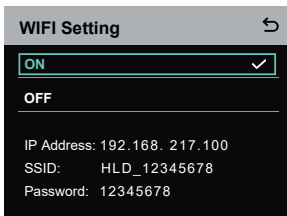

Operation Guide

- 1.2 Select **Wired Network Setting** to turn DHCP ON or OFF. If it is turned OFF, you can also modify the IP address, subnet mask, and gateway as well as view the user name and password for logging in to the web.

Wired Network Setting ↶

ON

OFF ✓

IP Address: 192.168.218.10 [Modify](#)

Subnet Mask: 255.255.255.0 [Modify](#)

Gateway: 192.168.218.1 [Modify](#)

User Name: admin

Password: 12345678

2. Select **M & R** to set the hub as the master device or remote device.
- 2.1 Select **Master Device** to set the hub as the master device.

Master And Remote ↶

Master Device ✓

Remote Device

- 2.2 Select **Remote Device** and then select **Scan** to scan the IP addresses of master devices on the network. Select the IP address of the corresponding master device in the displayed list and confirm it. Then, the hub is successfully set as the remote device.
- When a single hub is used, the hub needs to be set as the master device.
 - When more than two hubs are used in a cascaded connection, one hub needs to be set as the master device and the other hubs as the remote devices.

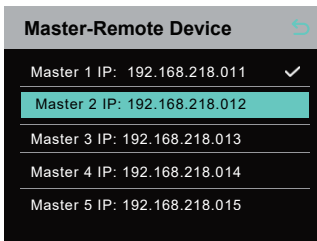

3. Select **Group** to perform group settings and view group status.
- 3.1 There are three options: **A group** (All devices are in group A), **AB group** (All devices are in groups A and B), and **Customize** (The group settings can be customized on the web. All devices are in group A by default).

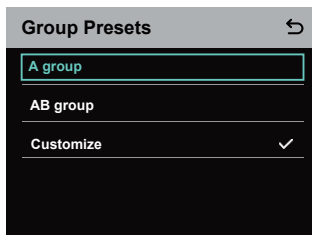

Operation Guide

3.2 Select **Group Review** to view group settings.

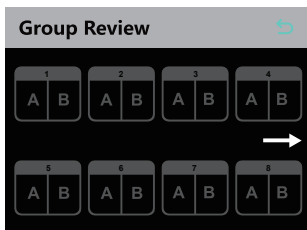

4. Select **PGM** to set the PGM audio gain according to the input volume.

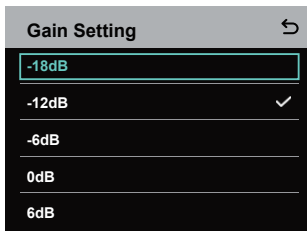

5. Select **4 Wire** to perform 4-wire audio settings.

5.1 Select **Input Gain** to set the input gain according to the input volume.

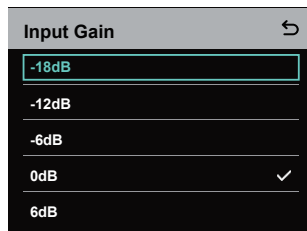

5.2 Select **Output Gain** to set the output gain according to the input volume.

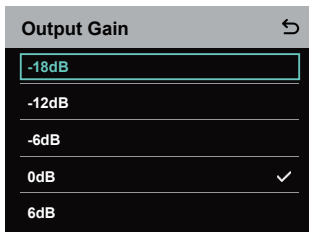

5.3 Select **Line Sequence Switching** to switch between **Standard** and **Cross** modes.

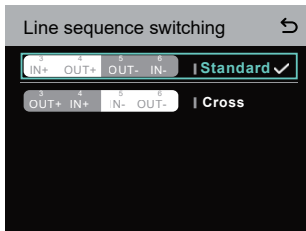

Operation Guide

6. Select **2 Wire** to perform 2-wire audio settings.
- 6.1 Connect the hub to a 2-wire device and set the corresponding cable compensation and terminal resistance on the hub. Power on the 2-wire device and turn OFF or disconnect its microphone to make sure that there is no other audio transmission on the 2-wire link. Otherwise, the accuracy of auto-null settings may be affected. After **Auto Null** is selected, auto-null settings for the 2-wire device will be performed automatically on the hub.
- 6.2 Select **Cable Compen** to check the 2-wire cable length and select the corresponding compensation option according to the cable length.

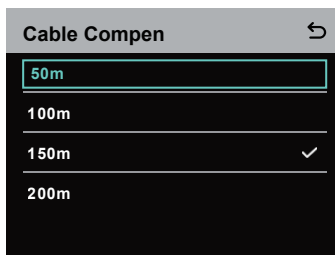

- 6.3 Select **Terminal Res** to check whether the 2-wire device connected via the 2-wire interface has terminal resistance. If it has, select **OFF**. Otherwise, select **ON**.

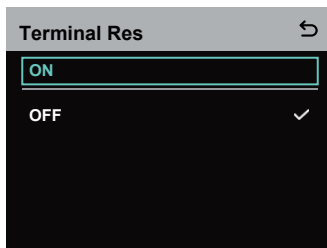

6.4 Select **Input Gain** to set the input gain according to the input volume.

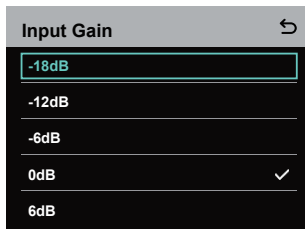

6.5 Select **Output Gain** to set the output gain according to the input volume.

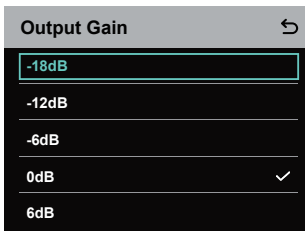

Operation Guide

7. Select **Language** to perform language settings. You can switch between Chinese and English.

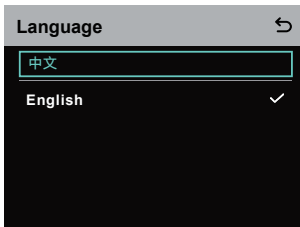

8. Select **Info** to check related information about the hub.

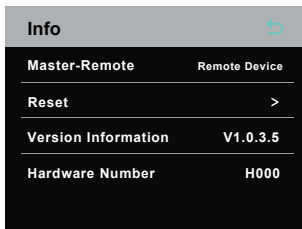

- 8.1 Select **Reset** to restore the configured hub information to the default settings.

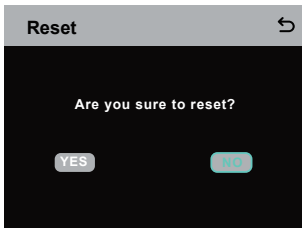

Operation Guide

Performing Group Settings via a Computer

- Select **Network > Wired Network Setting** to view the default IP address, user name, and password of the hub.

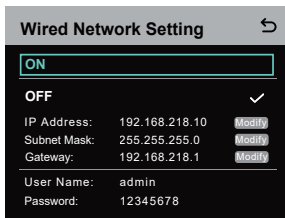

- Use a network cable to connect the hub to a computer via the RJ45 interface and set the IP address of the computer as **192.168.218.XXX**. The default IP address of the hub is **192.168.218.10**.



- Open a browser on the computer and visit <http://192.168.218.10> to enter the configuration page for the hub.

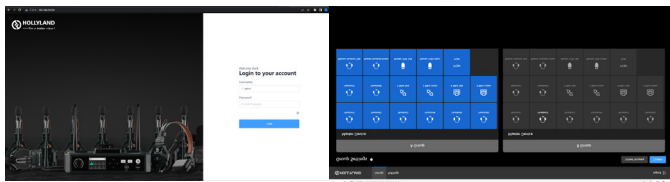

Operation Guide

Group A & B Buttons on Headsets

After group settings are performed on the hub, the A or B button on a connected headset will light ON. The button light status indicates which group the headset has joined. To join or exit group A or B, simply press the A or B button on the headset.

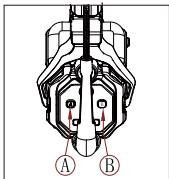

A & B Button Light Status	Description
ON in orange	The headset user is in the corresponding group. In this case, the headset user can hear and talk with the other headset users in the group.
OFF	The headset user is not in the corresponding group. In this case, the headset user cannot hear or talk with the other headset users in the group.

Cascaded Connection

Multiple hubs can be cascaded to expand the number of headsets. The hub supports two cascade methods — cascade via 4-wire analog signals and cascade via IP digital signals. Generally, it is recommended to cascade two hubs using 4-wire analog signals, and cascade three or more than three hubs using IP digital signals.

It is recommended to use a CAT5e cable for cascade and use the 568B standard for the RJ45 interface.

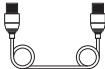
Standard Network Cable	Specifications	Max Length
	CAT5e CAT6e	300 meters

Two-System Cascaded Connection via the 4-Wire Interface

Use a standard network cable to connect two hubs via the 4-wire interface. The length of the network cable is up to 300 meters.

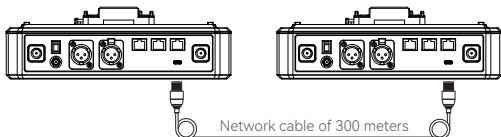

Operation Guide

4-Wire Settings

After connecting two hubs using a network cable, select **4 Wire > Line Sequence Switching** on the hubs, and then select **Standard** on one hub and **Cross** on the other hub.

Hub Display

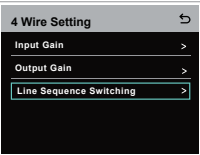
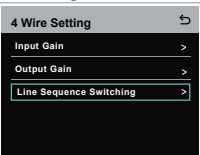
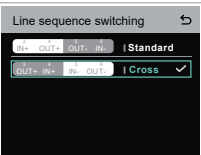
Hub ①	Select 4 Wire > Line Sequence Switching .	Select Standard .
4-Wire Settings		
Hub ②	Select 4 Wire > Line Sequence Switching .	Select Cross .
4-Wire Settings		

Two-System Cascaded Connection via the IP Network

Use a standard network cable to connect two hubs via the RJ45 interface. Either of the two RJ45 interfaces on the hub works. The length of the network cable is up to 300 meters.

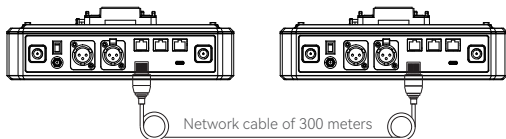

Operation Guide

M & R Mode Settings

After connecting two hubs using a network cable, select **M & R** on the hubs to set the hub mode. On one hub, select **Master Device**. On the other hub, select **Remote Device** > **Scan** and then select the IP address of the corresponding master hub. Note that the function of obtaining the IP address automatically under **Network** > **Wired Network Setting** needs to be turned OFF on both two hubs.

Hub Display

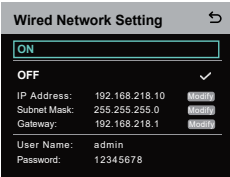
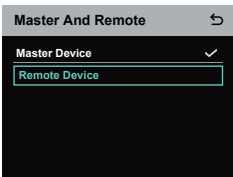
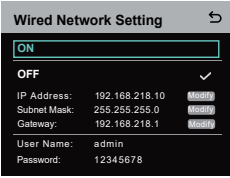
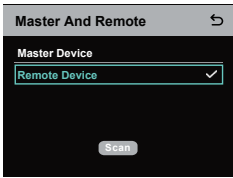
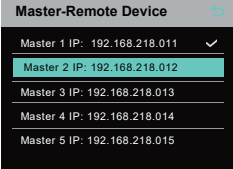
Hub ①	Select Network > Wired Network Setting > OFF.	Select M & R > Master Device.
Network Settings		
Hub ②	Select Network > Wired Network Setting > OFF.	Select M & R > Remote Device > Scan.
Network Settings		
	After Scan is selected, the IP addresses of master devices will be displayed. Then, select the desired IP address using the arrow buttons and press the Menu/Confirmation button to confirm the IP address.	

Operation Guide

Three-System Cascaded Connection via the IP Network

It is recommended to use the IP network connection to cascade three hubs. On one hub, select **Master Device**, and on the other two hubs, select **Remote Device**.

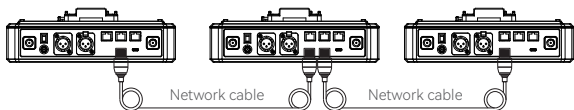

Parameters

Antenna	External
Power Supply	DC power, NP-F battery, V-mount battery, G-mount battery
Volume Adjustment	Adjustment knob
Power Consumption	< 4.5W
Dimensions	(LxWxH): 259.9mm x 180.5mm x 65.5mm (10.2" x 7.1" x 2.6")
Net Weight	About 1300g (45.9oz) with the antennas excluded
Transmission Range	1,100ft (350m) LOS
Frequency Band	1.9 GHz (DECT)
Bandwidth	1.728MHz
Wireless Technology	Adaptive Frequency Hopping
Wireless Power	≤ 21dBm (125.9 mW)
Modulation Mode	GFSK
RX Sensitivity	< -90dBm
Frequency Response	150Hz-7kHz
Signal-to-Noise Ratio	> 55dB
Distortion	< 1%
Input SPL	> 115dBSPL
Temperature Range	0°C to 45°C (working condition) -10°C to 60°C (storage condition)

Note:

1. The frequency band and wireless power vary by country and region.
2. The highest working temperature is 40°C when the adaptor is used for the power supply.

Safety Precautions

Do not place the product near or inside heating devices (including but not limited to microwave ovens, induction cookers, electric ovens, electric heaters, pressure cookers, water heaters, and gas stoves) to prevent the battery from overheating and exploding.

Do not use non-original charging cases, cables, and batteries with the product. The use of non-original accessories may cause electric shock, fire, explosion, or other dangers.

Support

If you encounter any problems in using the product or need any help, please contact Hollyland Support Team via the following ways:

 Hollyland User Group

 HollylandTech

 HollylandTech

 HollylandTech

 support@hollyland.com

 www.hollyland.com

Statement

All copyrights belong to Shenzhen Hollyland Technology Co., Ltd.

Trademark Statement

Without the written approval of Shenzhen Hollyland Technology Co., Ltd., no organization or individual may copy or reproduce part or all of any written or illustrative content and disseminate it in any form.

Note:

Due to product version upgrades or other reasons, this User Manual will be updated from time to time. Unless otherwise agreed, this document is provided as a guide for use only. All representations, information, and recommendations in this document do not constitute warranties of any kind, express, or implied.

HOLLYVIEW

Powered by Hollyland

Shenzhen Hollyland Technology Co., Ltd.

8F, 5D Building, Skyworth Innovation Valley,
Tangtou Road, Shiyan Street, Baoan District, Shenzhen, 518108, China

MADE IN CHINA