

# Mars 4K

Quick Guide

V1.0.0

## WELCOME

Thank you for purchasing the Mars 4K wireless video transmission system. Please read the quick guide carefully before using the product.

## KEY FEATURES

- 4K 30fps HDMI input and output
- Color LCD
- Smart channel selection upon power-on
- 66ms transmission latency
- 450ft (150m) wireless transmission distance (LOS range) for the receiver
- 260ft (80m) wireless transmission distance (LOS range) for the app
- SDI input and HDMI input for the transmitter
- SDI output and HDMI output for the receiver
- DC, NP-F battery, and USB-C power supply

# PACKING LIST

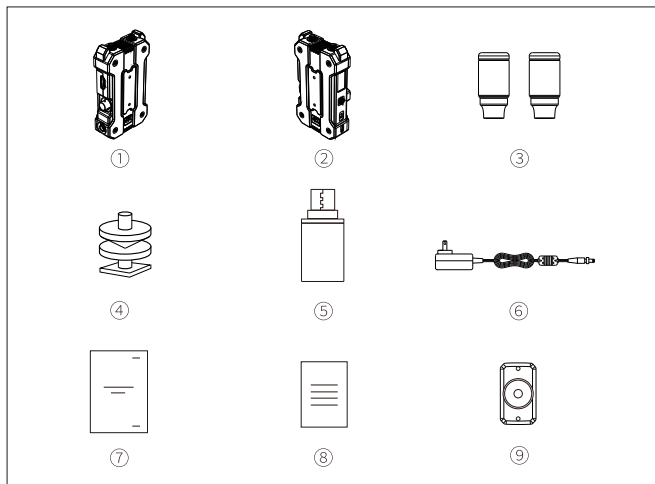

SKU	1 TX to 1 RX	1 TX	1 RX
① Transmitter	1	1	0
② Receiver	1	0	1
③ Antenna	5	2	2
④ Cold Shoe	1	0	0
⑤ Type-C OTG Converter	1	0	0
⑥ Self-locking DC Adapter	1	1	1
⑦ User Guide	1	1	1
⑧ Warranty Card	1	1	1
⑨ Expansion Accessory	1	1	0

Note: The quantity depends on the configuration and is subject to the actual list of equipment purchased.

## PRODUCT CONNECTION

### TYPICAL SETUP

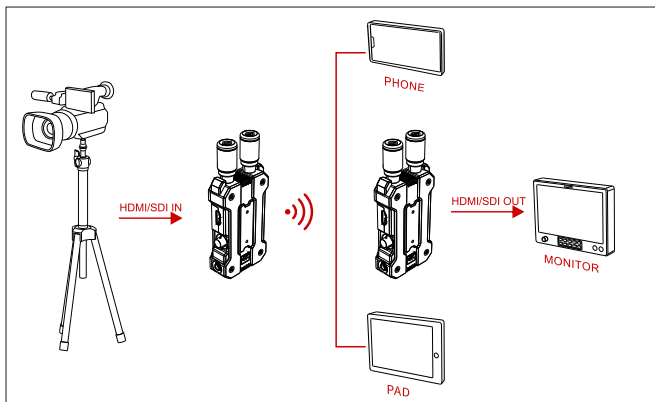

### DUAL MONITOR SETUP

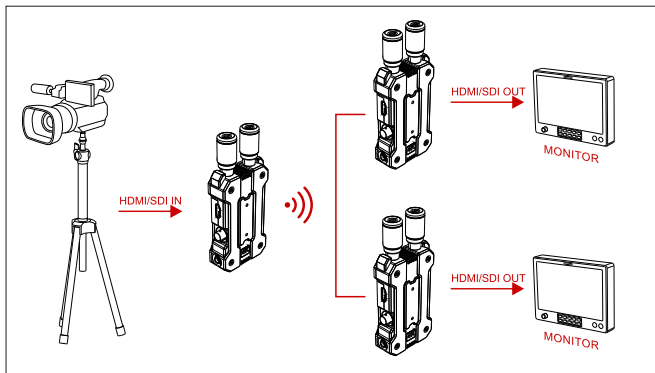

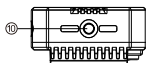
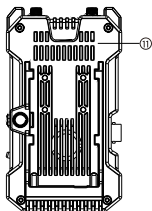
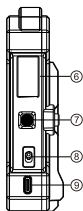
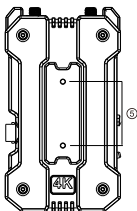
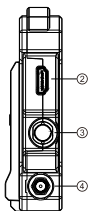
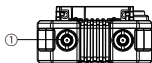

A

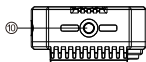
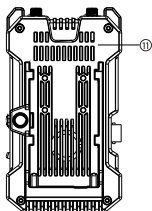
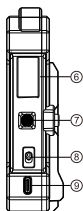
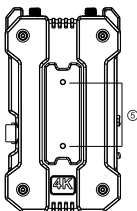
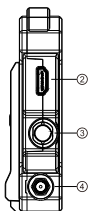
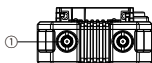

B

## **A** Transmitter:

- ① Antenna Interface
- ② HDMI Input
- ③ SDI Input
- ④ DC Power Input
- ⑤ Expansion Accessory Mounting Hole
- ⑥ Color LCD
- ⑦ Menu Button
- ⑧ Power Button
- ⑨ USB-C Interface
- ⑩ 1/4 Threaded Hole
- ⑪ Outlet

## **B** Receiver:

- ① Antenna Interface
- ② HDMI Output
- ③ SDI Output
- ④ DC Power Input
- ⑤ Expansion Accessory Mounting Hole
- ⑥ Color LCD
- ⑦ Menu Button
- ⑧ Power Button
- ⑨ USB-C Interface
- ⑩ 1/4 Threaded Hole
- ⑪ Outlet

# INSTALLATION

## INSTALLATION OF TRANSMITTER

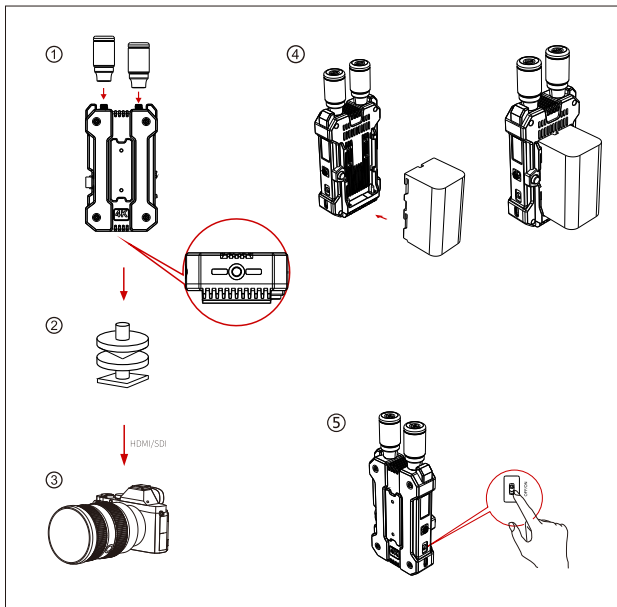

- ① Install the antenna shown in the picture.
- ② Install the transmitter on the camera with the cold shoe.
- ③ Connect the transmitter to the corresponding interface of the camera with an HDMI cable or SDI cable.
- ④ Install the battery (compatible with NP-F970, or other batteries of the same series).
- ⑤ Push the power button up to turn on the device.



# INSTALLATION

## INSTALLATION OF RECEIVER

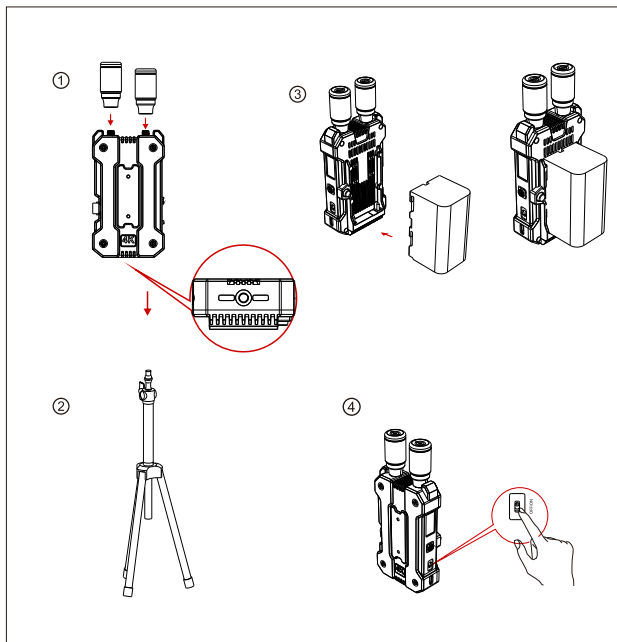

- ① Install the antenna shown in the picture.
- ② Install the receiver on the stand through the 1/4 threaded hole on the bottom of the device.
- ③ Install the battery (compatible with NP-F970, or other batteries of the same series).
- ④ Push the power button up to turn on the device.

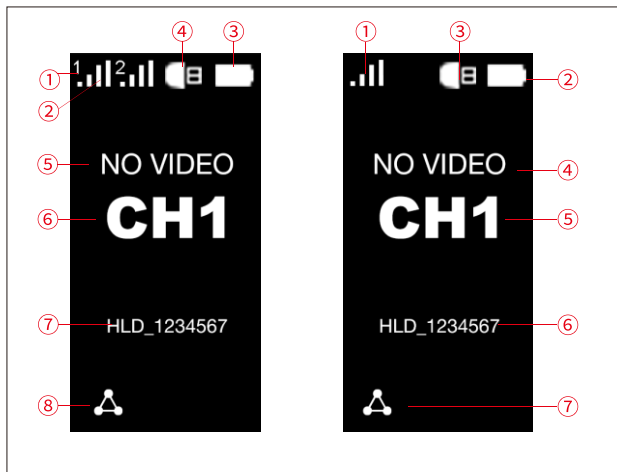

## **A** Transmitter:

- ① Receiver Number
- ② Signal Strength
- ③ Indicator of Power Supply
- ④ USB Plugged In
- ⑤ Video Format
- ⑥ Channel Display
- ⑦ Device Wi-Fi ID
- ⑧ Application Mode

## **B** Receiver:

- ① Signal Strength
- ② Indicator of Power Supply
- ③ USB Plugged In
- ④ Video Format
- ⑤ Channel Display
- ⑥ Device Wi-Fi ID
- ⑦ Application Mode

## QUICK GUIDE

### CHANNEL SELECTION

Push the rocker-styled button up or down on the transmitter or receiver and press the button to select a channel. The channels of the receiver and transmitter are synchronized automatically.

### MENU OPTIONS

After a channel is selected, press and hold the button for 3s to enter the menu options. You can push the button up or down to change the menu options.

### APP INSTALLATION AND CONNECTION

1. Download the HollyView app.



2. Connect the device to a mobile phone.

Find the WiFi named "HLD+DEVICE ID" on the mobile phone and enter the WiFi password (the default password is 12345678) to connect the device to the mobile phone. After the connection is successful, you can use the app on the mobile phone for monitoring.

## PARAMETERS

	<b>Transmitter</b>	<b>Receiver</b>
Interface	Antenna (RP-SMA male) HDMI 1.4 b input (Type-A female) 3G-SDI input DC input (2.0mm core socket) USB Type-C (USB 2.0 OTG)	Antenna (RP-SMA male) HDMI 1.4 b output (Type-A female) 3G-SDI output DC input (2.0mm core socket) USB Type-C (USB 2.0 OTG)
Power supply	DC input: 6V–16V USB Type-C: 5V/2.5A (not supporting the QC and PD protocols) NP-F battery: 6.8V–8.4V	DC input: 6V–16V USB Type-C: 5V/2.5A (not supporting the QC and PD protocols) NP-F battery: 6.8V–8.4V
Power consumption	<8.5W (typical)	<5W (typical)
Weight	223g (7.9oz) (excluding the antennas)	223g (7.9oz) (excluding the antennas)
Dimension	(LxWxH): 115x65x32mm (4.5"x2.5"x1.3")	(LxWxH): 115x65x32mm (4.5"x2.5"x1.3")
Operating frequency	5.1GHz–5.8GHz	5.1GHz–5.8GHz
Modulation mode	802.11n	802.11n
TX power	21dBm (max.)	21dBm (max.)
RX sensitivity	N/A	-90dBm
Bit rate	8Mbps–20Mbps	
Latency	0.06s (test data when 1080p60 signals are transmitted in a laboratory)	
Range	450ft (150m) (test data in an open, interference-free outdoor environment)	
Bandwidth	20MHz	
Audio format	2 audio channels for the 3G-SDI and 8 audio channels for the HDMI 1.4b	
Operating temperature	-10 °C to 60 °C	
Storage temperature	-40 °C to 60 °C	
ESD protection	Contact discharge: ±6kV; air discharge: ±8kV (test data)	

## PARAMETERS

HDMI Input Format	HDMI Output Format	SDI Output Format
720p50/59.94/60	720p50/60	720p50/60
1080i50/59.94/60	1080i50/60	1080i50/60
1080p23.98/24/25/29.97/30	1080p24/25/30	1080p24/25/30
1080p50/59.94/60	1080p50/60	1080p50/60
3840*2160 24/25/30	3840*2160 24/25/30	1080P24/25/30

SDI Input Format	HDMI Output Format	SDI Output Format
1080p50/59.94/60 (Level A)	1080p50/59.94/60	1080p50/59.94/60 (Level A)
1080p50/59.94/60 (Level B)		
1080i50/59.94/60	1080i50/59.94/60	1080i50/59.94/60
1080p23.98/24/25/29.97/30	1080p23.98/24/25/29.97/30	1080p23.98/24/25/29.97/30
1080psf23.98/24	1080p23.98/24	1080p23.98/24
1080psf25/29.97/30	1080i50/59.94/60	1080i50/59.94/60
720p50/59.94/60	720p50/59.94/60	720p50/59.94/60

## SUPPORT

If you have any problems in using the product or need any help, please visit the following to get more technical support.

 Hollyland Product User Group

 HollylandTech

 HollylandTech

 [Support@hollyland-tech.com](mailto:Support@hollyland-tech.com)

 [www.hollyland-tech.com](http://www.hollyland-tech.com)

**Note:** The frequency range and wireless TX power of the device vary based on the regulations of different countries and regions.

### **Safety Precautions**

Do not place the product near or inside heating devices (including but not limited to microwave ovens, induction cookers, electric ovens, electric heaters, pressure cookers, water heaters, and gas stoves) to prevent the battery from overheating and exploding.

Do not use non-original charging cases, cables, and batteries with the product.

The use of non-original spare parts may cause electric shock, fire, explosion, or other dangers.

**FCC Requirement**

Any changes or modifications not expressly approved by the party responsible for compliance could void the user's authority to operate the equipment.

This device complies with Part 15 of the FCC Rules. Operation is subject to the following two conditions:

- (1) This device may not cause harmful interference.
- (2) This device must accept any interference received, including interference that may cause undesired operation.

**Note:**

This equipment has been tested and found to comply with the limits for a Class B digital device, pursuant to Part 15 of the FCC Rules. These limits are designed to provide reasonable protection against harmful interference in a residential installation. This equipment generates, uses, and can radiate radio frequency energy, and if it is not installed and used in accordance with the instructions, it may cause interference to radio communications. However, there is no guarantee that interference will not occur in a particular installation. If this equipment does cause harmful interference to radio or television reception, which can be determined by turning the equipment off and on, you are encouraged to try to correct the interference by one or more of the following measures:

- Reorient or relocate the receiving antenna.
- Increase the distance between the equipment and receiver.
- Connect the equipment to an outlet on a circuit different from that to which the receiver is connected.
- Consult the dealer or an experienced radio/TV technician for help.