

Canon EFS LENS

EF-S60mm f/2.8 MACRO USM



 **ULTRASONIC**

ENG
Instruction

Thank you for purchasing a Canon product.

The Canon EF-S60mm f/2.8 MACRO USM lens is a macro lens that can be used for normal photography and close-up pictures up to 1:1, or life-size magnification. It has been developed for use with digital SLR cameras* compatible with EF-S lenses.

* As of February 2010, only the EOS 7D, EOS 50D, EOS 40D, EOS 30D, EOS 20D, EOS 20Da, EOS REBEL T2i/550D, EOS REBEL T1i/500D, EOS REBEL XSi/450D, EOS REBEL XS/1000D, EOS DIGITAL REBEL XTi/400D DIGITAL, EOS DIGITAL REBEL XT/350D DIGITAL, and EOS DIGITAL REBEL/300D DIGITAL are compatible with EF-S lenses.

● “USM” stands for Ultrasonic Motor.

Features

1. The three-group floating system results in excellent delineation at all focusing distances from life-size to infinity.
2. A Canon macro flash makes it easy to take close-up pictures with a flash. The inner focusing mechanism enables AF photography while the macro flash is attached.
3. Ultrasonic motor (USM) for quick and quiet autofocusing.
4. Manual focusing is available after the subject comes into focus in autofocus mode (ONE SHOT AF).

Conventions used in this instruction



Warning to prevent lens or camera malfunction or damage.



Supplementary notes on using the lens and taking pictures.

Safety Precautions

- **Do not look at the sun or a bright light source through the lens or camera.** Doing so could result in loss of vision. Looking at the sun directly through the lens is especially hazardous.
- **Whether it is attached to the camera or not, do not leave the lens under the sun without the lens cap attached.** This is to prevent the lens from concentrating the sun's rays, which could cause a fire.

Handling Cautions

- **If the lens is taken from a cold environment into a warm one, condensation may develop on the lens surface and internal parts.** To prevent condensation in this case, first put the lens into an airtight plastic bag before taking it from a cold to warm environment. Then take out the lens after it has warmed gradually. Do the same when taking the lens from a warm environment into a cold one.
- Do not leave the lens in excessive heat such as in a car in direct sunlight. **High temperatures can cause the lens to malfunction.**

This device complies with Part 15 of the FCC Rules. Operation is subject to the following two conditions: (1) This device may not cause harmful interference, and (2) this device must accept any interference received, including interference that may cause undesired operation.

Do not make any changes or modifications to the equipment unless otherwise specified in the instructions. If such changes or modifications should be made, you could be required to stop operation of the equipment.

This equipment has been tested and found to comply with the limits for a class B digital device, pursuant to part 15 of the FCC Rules. These limits are designed to provide reasonable protection against harmful interference in a residential installation. This equipment generates, uses and can radiate radio frequency energy and, if not installed and used in accordance with the instructions, may cause harmful interference to radio communications.

However, there is no guarantee that interference will not occur in a particular installation. If this equipment does cause harmful interference to radio or television reception, which can be determined by turning the equipment off and on, the user is encouraged to try to correct the interference by one or more of the following measures:

- Reorient or relocate the receiving antenna.
- Increase the separation between the equipment and receiver.
- Consult the dealer or an experienced radio/TV technician for help.

This Class B digital apparatus complies with Canadian ICES-003.

Nomenclature

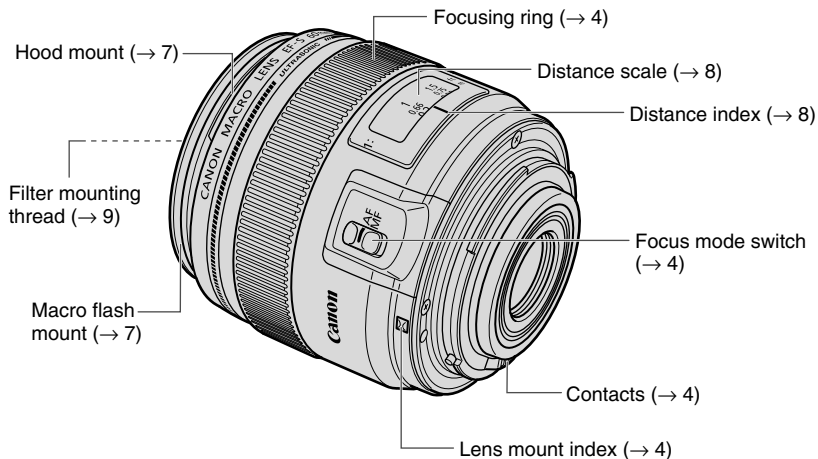

For detailed information, reference page numbers are provided in parentheses (→ **).

1 Mounting and Detaching the Lens

See your camera's instructions for details on mounting and detaching the lens.

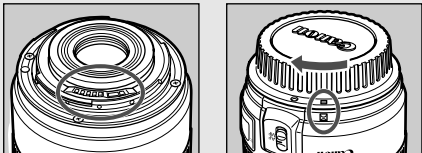

- After detaching the lens, place the lens with the rear end up to prevent the lens surface and electrical contacts from getting scratched.
- If the contacts get soiled, scratched, or have fingerprints on them, corrosion or faulty connections can result. The camera and lens may not operate properly.
- If the contacts get soiled or have fingerprints on them, clean them with a soft cloth.
- If you remove the lens, cover it with the dust cap. To attach it properly, align the lens mount index and the □ index of the dust cap as shown in the diagram, and turn clockwise. To remove it, reverse the order.

2 Setting the Focus Mode

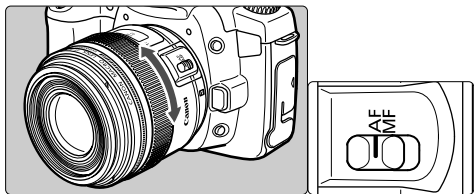

To shoot in autofocus (AF) mode, set the focus mode switch to AF.

To use only manual focusing (MF), set the focus mode switch to MF, and focus by turning the focusing ring. The focusing ring always works, regardless of the focus mode.



After autofocusing in ONE SHOT AF mode, focus manually by pressing the shutter button halfway and turning the focusing ring. (Full-time manual focus)

3 Picture Taking

Normal Photography

The lens can be used as a medium-telephoto lens equivalent to 96mm in 35mm format for normal photography such as snapshots and portraits.

Closeup Photography

Close-up photos up to 1x (life-size) magnification are possible. The minimum focusing distance of 20 cm is the distance from the subject to the focal plane. The working distance from the front of the lens to the subject is about 9 cm. When focusing, you can give priority to framing or to magnification.

[Framing Priority]

While looking through the viewfinder and framing the subject, focus with the AF or MF mode.

[Magnification Priority]

1. **Set the lens' focus mode switch to MF.**
2. **Set the magnification.**

While referring to the magnification scale on the lens, turn the focusing ring to the desired magnification.

3. Focus the subject.

While looking through the viewfinder, move the camera forward or back to find the point of focus.

4. Touch up the focus.

Turn the focusing ring for fine focusing.



Since macro shots have a very shallow depth of field, focus carefully to obtain proper sharpness.



- Image quality deteriorates near the minimum aperture opening due to diffraction.
- The magnification refers to the ratio between the subject's size and the corresponding image size on the focal plane. On the distance index, it is indicated as 1:x.
- To prevent camera shake, using a Remote Switch (both sold separately) and tripod is recommended.
- To check the depth of field, press the camera's depth-of-field preview button.

4 About Exposure

Setting the Exposure

When taking photographs using TTL metering, no exposure compensation is necessary to meter the light coming through the lens.

With TTL metering, AE (autoexposure) is possible at all focusing distances. Just set the desired picture-taking mode, then check the shutter speed and aperture before taking the picture.

Magnification and Effective f-number

The aperture displayed by the camera assumes that the focus is set to infinity. The actual aperture (effective f-number) becomes darker (effective f-number increases) at closer focusing distances (magnification increases). This does not cause exposure problems for normal picture-taking. However, for closeup photography, you cannot ignore the change in the effective f-number.

When you use a handheld exposure meter to set the exposure, you must take into account the exposure factor shown in the following table.

Magnification	1 : 5	1 : 4	1 : 3	1 : 2	1:1.5	1 : 1	
Effective f/No.	3.50	3.66	3.89	4.39	4.86	5.84	
Exposure Factor (stops)	in $\frac{1}{2}$ stops	$+\frac{1}{2}$	$+\frac{1}{2}$	+1	+1	$+1\frac{1}{2}$	+2
	in $\frac{1}{3}$ stops	$+\frac{2}{3}$	$+\frac{2}{3}$	+1	$+1\frac{1}{3}$	$+1\frac{2}{3}$	+2



- The correct exposure for a close-up shot largely depends on the subject. Therefore, it is recommended to take several shots of the same subject at different exposures.
- When taking close-up shots, it is recommended to use aperture-priority AE (Av) or Manual (M) picture-taking modes, because depth of field and exposure are easy to adjust in those modes.



If your eye will not be covering the eyepiece when the picture is taken (with remote control operation, etc.), use the eyepiece shutter or eyepiece cover. This prevents stray light from entering the eyepiece and throwing off the proper exposure.

5 Macro Flash (Sold Separately)

The Canon Macro Ring Lite MR-14EX or the Macro Twin Lite MT-24EX enables fully automatic macro flash photography up to 1x magnification in E-TTL autoflash mode.



- For information on operating the Canon Macro Ring Lite MR-14EX or the Macro Twin Lite MT-24EX, refer to the individual instruction booklets.
- Using aperture-priority AE (Av) or Manual (M) is recommended.

Flash Range (ISO100)

MR-14EX

MT-24EX

f-number →	32									
	22									
	16									
	11									
	8									
	5.6									
	4									
2.8										
1:	1	1.5	2	3	5	1	1.5	2	3	5

Magnification →

■ : Flash range

Flash Head Angle Settings for MT-24EX

Magnification	Inward Angle of Flash Head		
	45°	30°	15°
1 : 1 - 1 : 1.5	●		
1 : 2		●	
1 : 3		●	●
1 : 5			●

6 Hood (Sold Separately)

The ET-67B hood can keep unwanted light out of the lens, and also protects the lens from rain, snow, and dust.

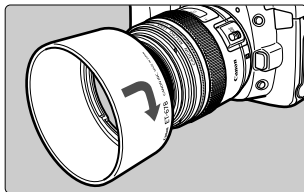

Attach and align the hood to the hood mount on the front of the lens, and turn the hood as shown by the arrow to secure it.

The hood can be reverse-mounted on the lens for storage.



- Part of the picture may be blocked if the hood is not attached properly.
- When attaching or detaching the hood, grasp the base of the hood to turn it. To prevent deformation, do not grasp the rim of the hood to turn it.

7 Infinity Compensation Mark

Infinity Compensation Mark

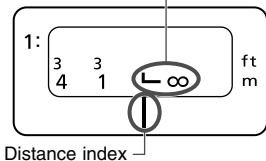

To compensate for shifting of the infinity focus point that results from changes in temperature. The infinity position at normal temperature is the point at which the vertical line of the L mark is aligned with the distance indicator on the distance scale.

 For accurate manual focusing on subjects at infinity distance, look through the viewfinder while rotating the focusing ring.

8 Close-up Lenses (Sold separately)

Attaching a 250D or 500D (52mm) Close-up Lens enables close-up photography.

The magnification will be as follows.

- Close-up Lens 250D: 1.33x - 0.25x
- Close-up Lens 500D: 1.18x - 0.12x

 Manual focusing is recommended for accurate focusing.

9 Filters (Sold Separately)

You can attach filters to the filter mounting thread on the front of the lens.



- This lens can accommodate both filters and the macro flash at the same time.
- If you need a polarizing filter, use the Canon Circular Polarizing Filter (52mm).
- To adjust the polarizing filter, first remove the lens hood.

10 Extension Tubes (Sold Separately)

You can attach Extension Tube EF12 II or EF25 II for magnified shots. The shooting distance and magnification are shown below.

	Camera-to-Subject Distance (mm)		Magnification	
	Near	Far	Near	Far
EF12 II	207	445	1.28×	0.20×
EF25 II	215	289	1.61×	0.44×



Manual focusing is recommended for accurate focusing.

11 Specifications

Focal Length/Aperture	60 mm f/2.8
Lens Construction	8 groups, 12 elements
Minimum Aperture	f/32
Angle of View	Diagonal: 24° 30' Vertical: 14° 10' Horizontal: 20° 40'
Min. Focusing Distance	0.2 m/0.7 ft.
Max. Magnification	1 ×
Field of View	15.1 × 22.7 mm/0.6 × 0.9 inch (at 0.2 m)
Filter Diameter	52 mm/2.0 inch
Max. Diameter and Length	73 × 69.8 mm/2.9 × 2.7 inch
Weight	335 g/11.8 oz
Hood	ET-67B (Sold separately)
Lens Cap	E-52U
Case	LP1016 (Sold separately)

- Equivalent to 96 mm in the 35mm film format.
- The lens length is measured from the mount surface to the front end of the lens. Add 21.5 mm when including the lens cap and dust cap.
- The size and weight listed are for the lens only, except as indicated.
- The EF1.4X II/EF2X II extenders cannot be used with this lens.
- Aperture settings are specified on the camera.
- All data listed is measured according to Canon standards.
- Product specifications and appearance are subject to change without notice.

Canon