

TAMRON®

SP 28-75mm F/2.8

XR Di LD Aspherical [IF] Macro (Model A09)

Thank you for purchasing the Tamron lens as the latest addition to your photographic equipment. Before using your new lens, please read the contents of this Owner's Manual thoroughly to familiarize yourself with your lens and the proper photographing techniques for creating the highest quality images possible. With proper handling and care, your Tamron lens will give you many years of photographing beautiful and exciting pictures.

NOMENCLATURE (Refer to Fig. 1, if not specified)

1. Lens hood
2. Hood attaching alignment mark
3. Hood attaching bayonet ring
4. Distance index
5. Focusing ring
6. Distance scale
7. Zoom ring
8. Focal length scale
9. Zoom/Aperture index mark
10. Lens attachment mark (Canon, Minolta Fig. 5)
11. AF-MF altering switch (Canon Fig. 5)
12. Lens mount/Lens mount contacts (Nikon)
13. Aperture ring (Nikon, Pentax Fig. 7)
14. F-number scale (Nikon, Pentax Fig. 7)
15. AE lock button (Nikon, Pentax Fig. 7)
16. F-number scale for finder display (Nikon)
17. Zoom ring lock switch (Fig. 3)
18. F-number index mark for long focal lengths (Fig. 1)

SPECIFICATIONS

	A09
Focal Length	28-75 mm
Maximum Aperture	F/2.8
Angle of View	75 – 32
Lens Construction	14/16
Minimum Focus Distance	0.33 m
Maximum Magnification Ratio	1:3.9 (at 75 mm)
Filter Size	67mm
Length	92mm
Diameter	73mm
Weight	510 g

* Lengths, diameters and weights listed are of lenses with Nikon mounts.

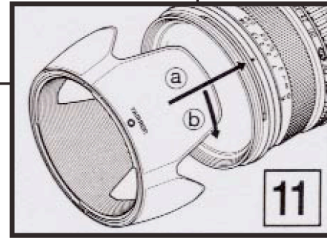
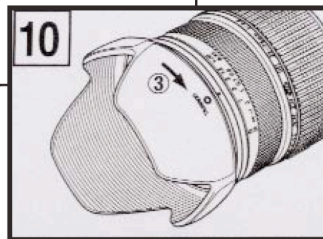
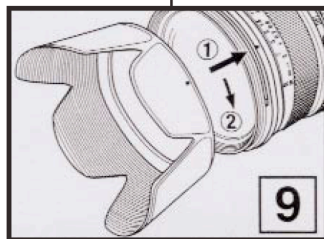
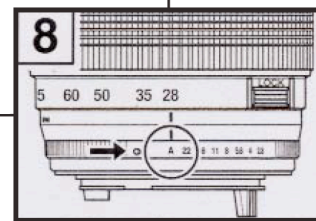
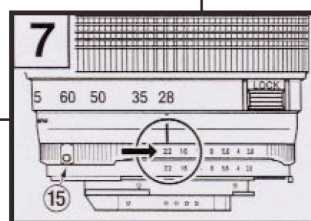
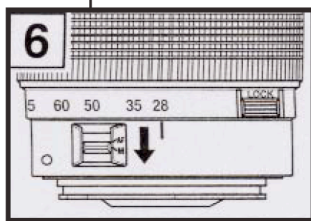
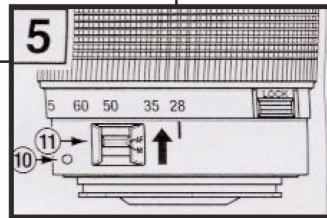
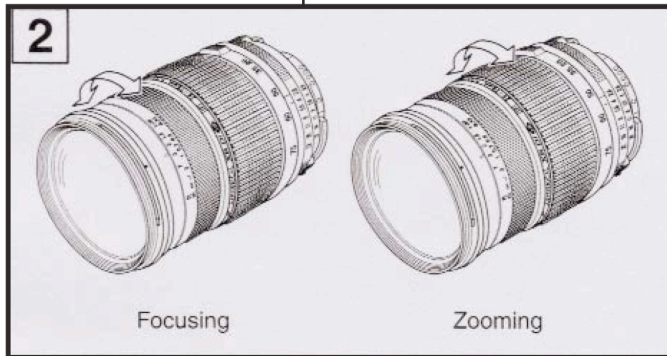
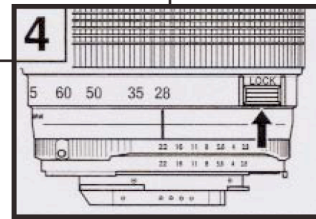
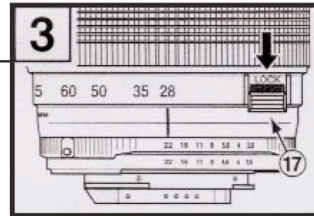
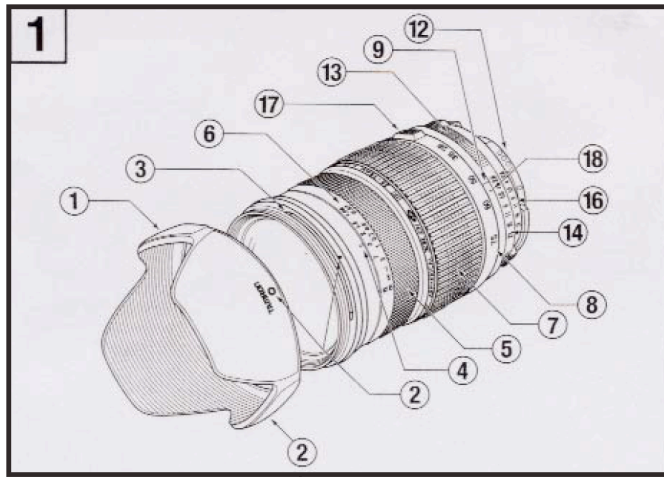

ATTACHING LENS TO CAMERA

- How to mount the lens

Removing the rear cap of the lens, align the lens attachment mark on the lens barrel with its counterpart on the lens mount of the camera and insert the lens mount into the camera's mount opening. Rotate the lens clockwise until it click-locks. For Nikon models, align the lens attachment mark with the dot on the camera and rotate the lens counter-clockwise until it click-locks.

- How to detach the lens

Pressing the lens release button of the camera down, turn the lens counter-clockwise (clockwise in case on Nikon), and lift the lens off the camera's lens mount.

* For further details, please read the instruction manual of your camera.

FOCUSING (Autofocus) (Ref. Figs. 1 & 2)

Set the camera on the autofocus mode (AF). Press the shutter button lightly while viewing through the camera's viewfinder, the lens focuses automatically. An in-focus mark will light when lens focuses on the main subject sharply. Press the shutter button further to photograph.

* Also, please read the camera's instruction booklet carefully.

- When set on AF mode, be very careful not to hinder the autofocusing movements of the lens. Such interference may cause a serious damage on the lens mechanism.
- Select between the autofocus and manual focus modes by the AF/MF mode selector switch on the lens barrel.

* For further details, please read the instruction manual of your camera.

FOCUSING (Manual Focus) (Ref. Fig. 2)

- Switch the focusing mode switch of the camera to manual focusing mode (MF) in case of Nikon, Minolta, or Pentax camera. In case of Canon, switch to MF on the AF-MF altering switch on the lens barrel. Focus manually, rotating the focusing ring while viewing through the camera's viewfinder. The main subject image in the viewfinder will be critically sharp on the viewfinder screen as lens focuses rightly.
- Press the shutter button lightly while operating the lens for focusing. The focus aid mark in the viewfinder will light up when the subject is in critical focus.
- Make sure the subject at infinity appears sharp in the finder when in focus. Because, the infinity position on the lens is made with certain allowance to assure right focus under a wide variety of photographing conditions.

* For further details, please read the instruction manual of your camera.

ZOOMING (Ref. Fig. 2)

- Rotate the zoom ring while viewing through the camera's viewfinder and compose your image with right focal length obtained.

ZOOM LOCK SWITCH (Ref. Fig 3 & 4)

Models A09 are equipped with a newly developed zoom lock switch mechanisms, which prevent lens barrels from extending toward long focal length by their own weight while hung from shoulders. Activated, the switches at 28mm settings to stop the lens barrels from rotating and extending.

How to activate the zoom lock switch mechanism

1. Locking: Set the lens to the 28-mm position. Move the zoom lock switch toward the camera for locking and zoom ring. In case of the model A09, the lens barrel is locked in position when the portion beneath "Lock" is shown in red and does not rotate or extend by its own weight.
2. Releasing: Push the switch away from your camera. The lens barrel is now free to rotate and extend for zooming.
 - The zoom lock switch cannot be activated unless the lens is set to the 28-mm position. Do not force the lock switch or do not try to rotate the lens barrel while locked.
 - The lens can be used at 28-mm setting for picture taking even when locked by the switch.
 - The zoom lock mechanism is made to prevent the lens barrel from extending while carried around on the shoulder. When not locked, the zoom lens may change its focal length during a long exposure if used while in a low or high angle position.

LENS APERTURE AND AE MODE (Ref. Fig. 7 & 8)

- Setting lens f-numbers with Canon & Minolta cameras

Set the f-number with aperture setting device of the camera body in accordance with the selected photographing mode.

* For further details, please read the instruction manual of your camera.

- Setting the f-numbers with Nikon & Pentax cameras

Photographing in a programmed-AE or a shutter-speed-priority-AE mode, rotate the lens aperture ring to the minimum aperture setting position, in the case of a Nikon camera, and set on the "A" position in the case of a Pentax camera. The aperture ring will be locked in position automatically. When shooting in an aperture-priority-AE or manual-exposure mode, release the lens aperture ring by rotating the ring from the AE lock position and depressing the Aperture ring lock button. If your camera is a Nikon F401 or F50, you can set the aperture to any desired f-number, leaving the aperture ring at the minimum opening position.

* The lens aperture varies with zooming movement. Cameras read the different lens openings and automatically adjust the exposure properly.

* For further details, please read the instruction manual of your camera.

LENS HOOD (Ref. Figs. 1, 9, 10 & 11)

A bayonet-type lens hood is provided as a standard accessory. We recommend shooting with the hood attached whenever possible as the lens hood eliminates stray light, which is harmful to the picture. However, please be aware of the precautions written below when your camera is equipped with a built-in flash.

- Attaching the Lens Hood (Ref. Fig. 9 & 10)

Align the index mark on the hood with the corresponding index mark (O or the top of the index line of the distance scale) on the lens. Press the hood lightly onto the hood attaching bayonet ring (Fig. 9, No. 1) and then rotate it clockwise to secure (Fig. 9, No. 2). The lens hood will be securely held as the mark "TAMRON O" comes to the top (Fig. 10, No. 3). When attaching the lens hood, hold the focusing and zoom control rings so that they are not rotated unintentionally.

* Pay particular attention to align the hood attaching indices when using zoom lenses including wide-angle (i.e. 35mm or wider) settings. Improper attachment of a hood for wide-angle zoom lens may cause large shadowed areas in your pictures.

- Stowing Lens Hood
 - a. Detach and reverse lens hood then, align alignment mark of lens hood (TAMRON O) with alignment mark of lens. (Fig. 11,a).
 - b. Press lens hood evenly onto bayonet ring and turn hood clockwise until stop. When stopped, alignment mark of hood will be placed at top.

DEPTH OF FIELD

- With a camera equipped with a depth-of-field-preview button or a aperture-stop-down mechanism, the depth-of-field can be directly observed on the viewfinder screen of your camera. For the operational details, read the instruction manual of your camera.

* In case you need a depth-of-field table of your lens, please ask for it at a Tamron distributor or a service station.

* You can also download a depth-of-field table of your interest from our website.
Tamron URL: <http://www.tamron.co.jp>

INFRARED PHOTOGRAPHY

Please be aware that there is no infrared index line on any models listed on this owner's manual, and therefore, practically no black-and-white infrared film can be used with these lenses.

PRECAUTIONS IN SHOOTING

- The Tamron lenses, AP AF28-75mm (Model A09) employ an internal focusing (IF) system to achieve a remarkable minimum photographing distances of 0.33 meter (1.08 feet). Because of the characteristics of this optical design, the angles of view at distances other than infinity are wider than that of the lenses applying an ordinary focusing system.
- When the built-in flash on the camera is used, adverse photographic phenomena such as corner illumination fall-off or vignetting at the bottom part of the image may be observed, especially in wide-angle ranges. This is due to the inherent limitation of coverage of the built-in flash, and/or the relative position of the flash to the edge of the lens barrel, which causes shadows on the image. It is strongly recommended to use a suitable separate flash unit provided by the camera manufacturer for all flash photography.

* For further details, please read the "built-in flash article on the instruction manual of your camera.

- When using the lens in the telephoto focal range, it may be necessary to use a tripod to avoid camera shake. Using high-speed film (ISO 400 or faster) with a fast shutter speed is also helpful to reduce the influence of camera shake.
 - Tele-converters are efficient tools to add focal length to the photographer's telephoto lenses including zoom lenses but cannot be recommended for use with wide-angle lenses or zoom lenses that cover wide-angle range focal lengths.
- * When a tele-converter is attached, the focal length of the lens becomes longer but the depth of field becomes shallower and it may be difficult to focus in AF mode. Therefore, focusing in MF (Manual Focusing) mode is recommended when a tele-converter is used. 2X tele-converters cannot be used with this lens. Do not use 2X tele-converters.
- Certain camera models may indicate the maximum and minimum aperture values of the lens as inappropriate numbers. This is inherent to the design of the camera and not an indication of an error.

TO ENSURE LONG-TERM SATISFACTION

- Avoid touching the glass element surface. Use a photographic lens cloth or blower to remove dust from the lens element surface. When not using the lens, always place a lens cap on it for protection.
- Use a lens cleaning tissue or a lint cloth with a drop of cleaning solution to remove fingerprints or dirt on the glass lens surface with a rotary motion from the center to the edge. Use a silicon cloth to clean your lens barrel only.
- Mildew is an enemy of your lens. Clean the lens after shooting near water or in any humid place. Store your lens in a clean, cool and dry place. When storing the lens in a lens case, store it with a commercially available drying agent such as silica gel, and change the agent occasionally. If you find mildew on your lens, consult a repair shop or nearby photographic store.
- Do not touch the lens-camera interface contacts since dust, dirt and/or stains may cause contact failure between the lens and camera.
- When using your equipment [camera(s) and lens(es)] in an environment where the temperature changes from one extreme to the other, make sure to put your equipment temporarily in a case or a plastic bag for a length of time in order for the equipment to go through a gradual temperature shift. This will reduce potential equipment trouble.