



A20-Mini

Digital Wireless Transmitter
with **GainForward** and **SpectraBand Technologies**

User Guide v7.40

Table of Contents

Welcome to the A20-Mini	3
SpectraBand	4
Panel Views	4
Power	7
A20-Mini Holster	8
Introduction to A20-Remote	9
A20-Remote Overview	10
Manage Transmitters	13
Transmitter List	16
Transmitter View	20
Group Control	24
Group Setup	24
Group View	25
Connecting Lavalier Microphones to A20-Mini	28
Tuning A20-Mini and the Receiver	28
GainForward	28
Recording WAV Files	28
Jamming Timecode on A20-Mini	29
File Transfer to a Computer	29
Updating A20-Mini Firmware	30
SD-Utility	31
A20-BatteryDoublor	34
PowerStation-8M	35
PowerStation-8M Specifications	37
A20-Mini Specifications	38
Antenna Guide	40
Servicing the A20-Mini	41
Warranty	41
Included Accessories	41
Legal Notices	42
Declaration of Conformity	45

Welcome to the A20-Mini

Sound Devices' first miniature transmitter incorporates state-of-the-art features such as full remote control via the A20-Remote app, long range modulation, GainForward Architecture, SpectraBand's 470 MHz – 1525 MHz tuning range, internal 32-bit float recording, and more. The A20-Mini is fully compatible with the A20-Nexus, A20-RX and the A10-RX.

- Worldwide tuning range of 470 MHz – 1525 MHz.
- Full remote control of the Mini via the A20-Nexus receiver or A20-Remote companion app.
- State-of-the-art 100% digital long-range modulation delivers the longest transmission distance of any system on the market.
- GainForward Architecture: set the Mini's gain levels via trim control (with an 8-Series or other mixer) or at the A20-Nexus/A20-RX/A10-RX.
- Full 10 Hz – 20 kHz audio bandwidth; 100% digital RF modulation and transmission. Same excellent range and audio quality as the A10-TX.
- Built-in 32-bit float, 48 kHz recorder with 64 GB storage for over 80 hours of record time.
- USB-C for file offload and optionally conform/convert with SD-Utility.
- Powering via Lithium AAA or NP-BX1 (Li-Ion) batteries with built-in charging for NP-BX1.
- Double the battery run time with the A20-BatteryDoubler accessory
- Internal timecode generator with supercapacitor backup can be jammed via USB-C.
- Water-resistant with a rounded form factor.

Our friendly and knowledgeable support team, based in the USA and the UK, is here for all your questions and comments. Our job is to make your job easier.

We are honored to be part of your kit.

Sincerely,
Sound Devices

SpectraBand

The A20-Mini introduces SpectraBand, a technology that enables the A20-Mini to tune over a super wide range of 470-1525 MHz. Tuning within this range varies by country. For instance:

In the USA, the available frequency ranges are:

- The entire UHF TV band (470-608 MHz)
- The 600 MHz guard band (614-616 MHz)
- The 600 MHz duplex gap (653-663 MHz)
- The 900 MHz ISM Band (902-928MHz)
- The 950 MHz STL Band (941.5-960 MHz)
- The 1.5 GHz AFTRCC band (1435-1525 MHz), with an appropriate license.

In the UK, the available frequency ranges are:

- The core UK UHF TV band (470-702 MHz)
- The 800 MHz duplex gap (823-832 MHz)
- The 800 MHz guard band (863-865 MHz)
- The DME bands (961-1015 MHz, 1045-1075 MHz, 1105-1154 MHz), with an appropriate license.
- The IMT band (1518-1525 MHz)

Please see <https://www.sounddevices.com/available-frequencies/> for further detailed information on which frequency ranges are available for each country.

Panel Views

Top and Bottom Panels

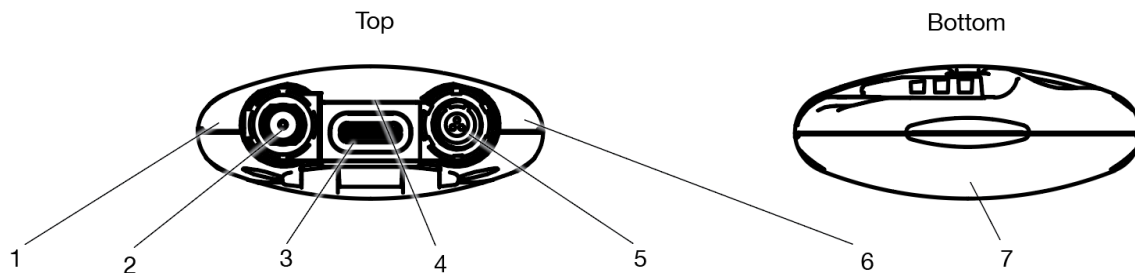

1: Battery Power LED

Indicates the state of battery life.

Green = Good

Orange = Marginal, about an hour of battery life remaining.

Red = Low, 15-20 minutes of battery life remaining.

Flashing Red = Critically low, RF, audio, and recording disabled.

Blue = Batteries inserted. Power LED is blue when batteries are inserted and goes off when the unit is ready to be powered on by the red button or from the A20-Remote app.

2: Antenna Connector

SMA connector. Attach antenna with a length specific to the frequency in use. Using the wrong length of antenna reduces RF range. See Antenna Guide for more information.

3: USB-C Port

Multifunction port used for:

Powering A20-Mini
Charging internal Sony NP-BX1 rechargeable battery (not included)
Timecode input and output
Transferring files to and from a computer

4: Charge/Pairing/Record/Media/Timecode Jam LED

Indicates charging, Bluetooth pairing, recording, media activity, and timecode status.

Solid Orange = Charging
Solid Green = Charging complete
Off = No charging
Solid Red = Recording
Flashing Red = Recording stopped due to full media or recording error
Flickering Blue = Media activity
Flashing Blue = Timecode Jam in progress
Pulsing Blue = Timecode Output active
Rapid Flashing Blue = Bluetooth Pairing

5: Lavalier Microphone Input

3-Pin LEMO connector for connecting a lavalier microphone. Can be set to power transmitter on and off via lav mic connection and disconnection.

6: Audio/Timecode LED

Audio/Timecode LED indicates audio activity and timecode status.

Green (variable intensity) = Audio activity from lavalier microphone
Red = Microphone clipping
Solid Blue = Microphone is muted
Pulsing Blue = Timecode 00 frame (only when unit is off)

Note: Due to the high dynamic range of the microphone input, under normal use the audio LED should never light up red. If it does, this is an indicator that the microphone itself (not the mic preamp) is clipping and the audio level should be attenuated acoustically by moving the mic capsule or using a lower sensitivity microphone.

7: Bottom Panel Charge/Pair/Record/Media/Timecode LED

LED indicates charging status, timecode sync, Bluetooth pairing, recording, and media activity. Positioned on the bottom of the A20-Mini to make it easily visible when slotted into the optional PowerStation-8M.

Solid Orange = Charging
Solid Green = Charging complete
Off = Not charging
Solid Red = Recording
Flashing Red = Recording stopped due to full media or recording error
Flickering Blue = Media activity
Flashing Blue = Timecode Jamming
Pulsing Blue = Timecode 00 frame (when unit is off and jammed timecode is held or when Timecode Output is active following a jam)
Rapid Flashing Blue = Bluetooth Pairing

Front, Front (Door Open), Left, Right and Back Panels

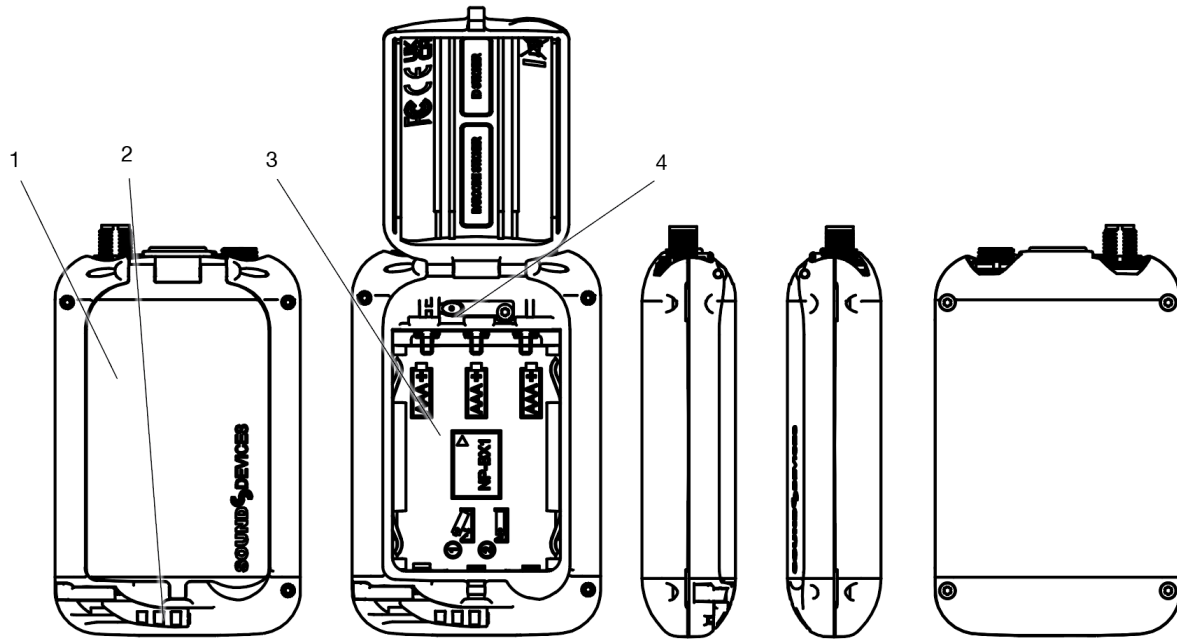

1: Battery Door

Access to the battery compartment and red button. The battery door can be easily swapped with the A20-BatteryDoubler accessory which gives double the battery run time.

2: Door Latch

Slide left to unlock the battery door.

3: Battery Compartment

Accepts either 3x AAA Lithium batteries or one rechargeable Sony NP-BX1 Li-Ion battery. Sound Devices recommends using genuine Sony NP-BX1 or Energizer AAA Lithium primary batteries for best performance. Alkaline and NiMH are not recommended because of compromised run times.

4: Red Button

This button is used to power the A20-Mini on or off and enter Bluetooth Pairing mode.

Power On = Press and release button.

Power Off = Press and hold button for 3 seconds.

Pairing Mode = While A20-Mini is off, press and hold button for 5 seconds. The Pairing LED on the bottom and top panel flashes blue rapidly while in Pairing mode.

Power

The A20-Mini powers via USB-C, 3x Energizer AAA Lithium primary batteries, one Sony NP-BX1 Li-Ion battery, or two Sony NP-BX1 Li-Ion batteries (when fitted with the A20-BatteryDoubler accessory).

Opening the Battery Door

To open the A20-Mini battery door:

1. Slide the door latch to the left to unlock the battery door.
2. Lift the battery door using the indented space on the bottom right-hand side of the battery door.

Closing the Battery Door

To close the A20-Mini battery door:

1. Slide and hold the door latch to the left.
2. Close the battery door.
3. Release the door latch to lock the battery door.

Powering from AAA or Sony NP-BX1 Li-Ion

To power the A20-Mini using AAA batteries or Sony NP-BX1 Li-Ion:

1. Open the A20-Mini battery door.
2. Insert three AAA batteries or one Sony NP-BX1 Li-Ion into the battery compartment, taking care to place the batteries in the correct orientation.
3. AAA batteries should be inserted with the negative side (without springs) first.
4. Sony NP-BX1 should be inserted with the contact side (with springs) first.
5. Power LED is blue when batteries are inserted and goes off when the unit is ready to be powered on. Press and release the red button to power on the A20-Mini.
6. Close the A20-Mini battery door.
7. To power off the A20-Mini, press and hold the red button for three seconds. The Power LED flashes rapidly while the A20-Mini powers off. The Power LED is off when the unit is off.
8. To remove the batteries, open the battery door and remove the AAA or NP-BX1 battery with the non-spring side first.

Note: The A20-Mini resumes its prior power state upon battery insertion.

Powering from Two NP-BX1 Batteries for Extended Run Time

Use the optional A20-BatteryDoubler accessory to double the A20-Mini run time. See A20-BatteryDoubler for more details.

USB-C

USB-C can be used to power the A20-Mini and/or to charge inserted Sony NP-BX1 batteries. The A20-Mini does not charge AAA batteries. USB-C is the priority power source whenever connected.

To power the A20-Mini via USB-C:

1. Connect a USB power source to the A20-Mini's USB-C port.
2. Open the battery door then press the red button.
3. To power the A20-Mini off, press and hold the red button for three seconds.

To charge the Sony NP-BX1 from USB-C:

1. Open the battery door and insert a Sony NP-BX1 into the battery compartment.
2. Connect a USB power source to the A20-Mini USB-C port.
3. The Charge/Pair/Rec LED glows solid orange while the battery is charging. The Charge LED turns solid green when charging is complete.

The A20-Mini is fully operational when charging batteries from USB-C.

PowerStation-8M

The PowerStation-8M is an optional accessory for the A20-Mini. An A20-Mini using a Sony NP-BX1 battery can be inserted into a charging bay of the PowerStation-8M to charge the battery. See PowerStation-8M for more details.

Auto Power On and Off with PowerStation-8M

The A20-Mini automatically powers off when inserted into a charging bay of the PowerStation-8M. To save time from having to manually power on the A20-Mini, use the Power On When Removed from the PowerStation-8M feature. When this feature is

selected, removing an A20-Mini from the PowerStation-8M immediately powers on the transmitter. This feature is turned on or off in the A20-Remote application. See A20-Remote for more details.

Auto Power with Lav Mic Connection

When Auto Power with Lav Mic Connection is selected, connecting a lavalier microphone to the A20-Mini automatically powers on the transmitter. Removing the LEMO connection automatically powers the A20-Mini off.

This feature can be turned on or off in the A20-Remote application. See A20-Remote for more details.

Estimated Battery Runtime

The A20-Mini can operate for up to 5.5 hours (or 9 hours with the BatteryDoubler). Battery rundown times will vary depending on setup and workflow. Utilize the A20-Mini's ability to power the unit on and off remotely from the A20-Remote app to extend battery runtime.

A20-Mini Holster

The A20-Mini ships with an easy-to-assemble holster. The A20-Mini can be inserted with the antenna and lavalier microphone coming out of the top or bottom of the holster.

Inserting the A20-Mini in the A20-Mini Holster

Slide the A20-Mini into the A20-Mini Holster's pocket in the orientation that works best for the situation. Fold the security flap over, securing the transmitter in place using the hook-and-loop fastener strips. Use the clip on the back of the holster to attach the transmitter to the talent's garments.



Introduction to A20-Remote

A20-Remote is an application for Android/iOS phones and tablets designed to pair with the A20-Mini. All settings for the A20-Mini are conveniently controlled using A20-Remote.



When connected via Bluetooth LE to the A20-Mini, A20-Remote offers control and display of all A20-Mini parameters, including:

- Power on and off the A20-Mini
- Monitor battery status
- Frequency, Modulation, and RF power setup
- Monitor audio signal presence
- Microphone mute
- Transport controls (Record, Stop)
- Timecode display
- Media formatting and monitoring of remaining space
- A20-Mini settings (Mode, power options, and more)
- Group control of powering, recording, and more

Download and install the A20-Remote app from the Google Play Store or Apple App Store.

<https://www.sounddevices.com/a20-remote>

A20-Remote has the following minimum operating requirements: Android tablets and phones running Android 8+, or iPad and iOS devices running iOS 13+. The device must have Bluetooth and Location Services on in order to connect with an A20-Mini.

IMPORTANT: The mobile device's location is used to determine available frequencies, RF power levels, and TV channel mapping of the A20-Mini. The Country setting is automatically set using the mobile device's Location Services.

The mobile device's system date and time are used in the metadata of recorded files.



A20-Remote Overview

Tablet View

The screenshot displays the A20-Remote interface in tablet view. It is divided into several sections:

- Transmitter List (Left):** A list of transmitters under two categories: 'Custom Group' (3 Transmitters) and 'All Transmitters' (5 Transmitters). The list includes:
 - Gerald:** 03:46:11:04, 514.600 MHz, 70% battery.
 - Nancy:** 03:46:11:06, 512.600 MHz, 90% battery.
 - Zoes:** 03:46:11:04, 545.400 MHz, 94% battery.
 - Rick:** 03:46:11:09, 594.200 MHz, 65% battery.
 - Delores:** 523.000 MHz, 92% battery.
- Settings (Top Center):** A gear icon (2) for configuration.
- Transmitter Detail (Right):** A large panel for the selected transmitter 'Gerald' (5). It shows:
 - Frequency: 514.600 MHz (6)
 - RF Power: Normal
 - Time: 03:46:11:04 (7)
 - 23.98 fps
 - 00:11:21
 - 32-bit float / 48 KHz
 - Remaining: 89h50m / 62.0 GB
 - 70% Li-ion battery (8)
 - ON/OFF power buttons (9)
 - REC recording button
 - Buttons for Name, Mute Mic, Mode, Format, Modulation, Frequency, RF Power, LEDs, Options, and Information.

At the bottom, the version 'A20-Remote version - 5.00.005' and the 'SOUND DEVICES' logo are visible.

Phone View

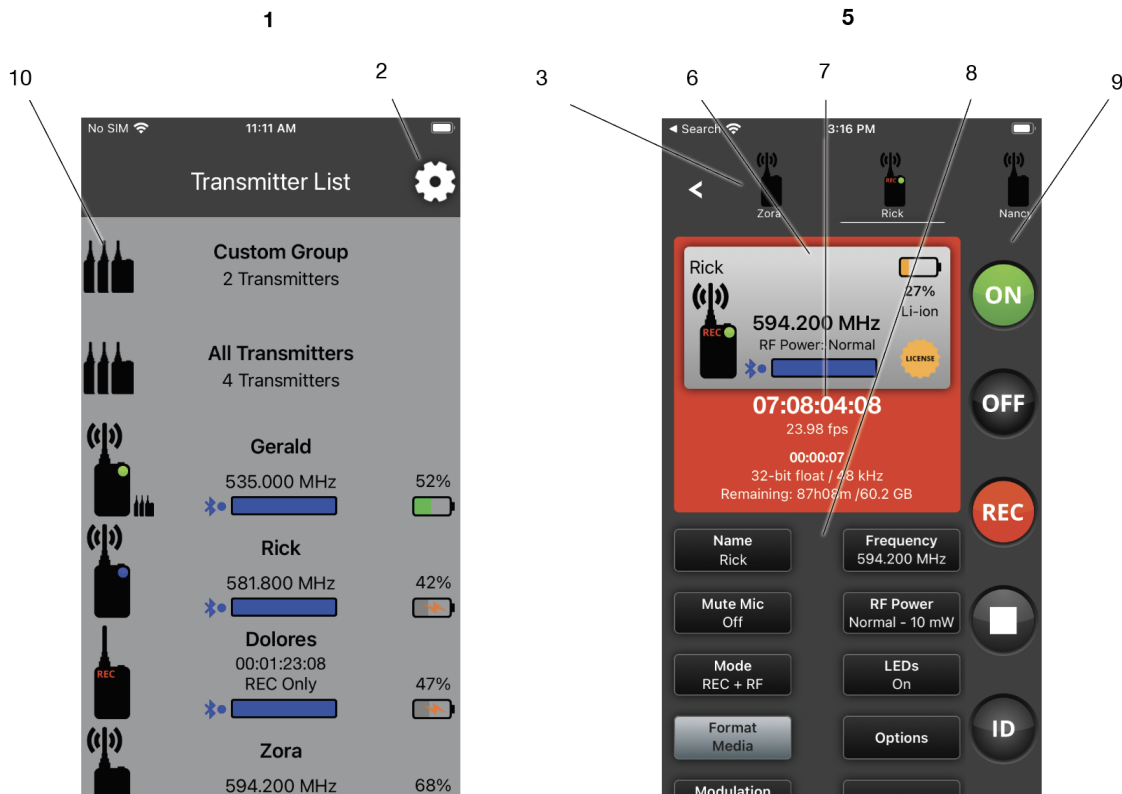

1: Transmitter List

Scroll to see all available transmitters in the Transmitter List. Touch a transmitter or transmitter group to display the Transmitter View or Group View. Transmitters that are enabled from Manage Transmitters appear in the Transmitter List. See Transmitter List for more details.

2: Manage Transmitters

Touch the Gear icon to access Manage Transmitters. From Manage Transmitters, pair transmitters, enable transmitters, set Country, setup groups, unlock Restricted Frequencies, access A20-Mini User Guide, and view A20-Remote version information.

3: Transmitter Quick List (Phone View Only)

From a phone, the Transmitter List and Transmitter View are not displayed simultaneously. The Quick List is a simplified version of the Transmitter List allowing for quick selection of transmitters from the Transmitter View. The list is horizontally scrollable and lists transmitters by name with their Status indicator. Touch the Back button to return to the Transmitter List.

4: Active Transmitter or Group

Touch any transmitter or Group in the Transmitter List to make it the active view. From a tablet, the highlighted transmitter or group in the Transmitter List indicates the active transmitter or group shown in the Transmitter View displayed on the right-hand side of the app. From a phone, the active transmitter or group is the one displayed in the Transmitter View and underlined in the Transmitter Quick List.

5: Transmitter View

Displays the active transmitter's status window and provides access to the transmitter's menus and controls.

6: Transmitter Status Window

Displays the active transmitter's name, transmitter status, battery life, power source, frequency, RF power level, licensed frequency icon, and Bluetooth signal strength meter.

7: Record and Timecode Window

Displays the current timecode value, frame rate, absolute time of recording, and the remaining time and space of media. The window is red when the transmitter is actively recording. This window is not displayed when A20-Mini Mode is set to RF Only.

8: Transmitter Menu

This menu offers control of the active transmitter's Name, Frequency, Mute Mic, RF Power, Mode, and power options. The menu also provides access to format media and information about the transmitter.

9: Transmitter Controls

Allows control of the active transmitter's Power On, Power Off, Record, Stop, and Identify mode.

10: Transmitter Groups, Group View

See Group Control for details.

Manage Transmitters

Manage Transmitters is the first page displayed when launching the A20-Remote app if no transmitters have been paired to the mobile device.

Manage Transmitters displays all transmitters within range that are in Pairing mode and any A20-Mini that has been previously paired to the mobile device. Transmitters appear in Manage Transmitters with transmitter name and current firmware version. Paired transmitters that are not within Bluetooth range or are connected to another device are displayed in italics and the Enable switch is grayed out. Enter Manage Transmitters at any time by touching the Transmitter List gear icon.

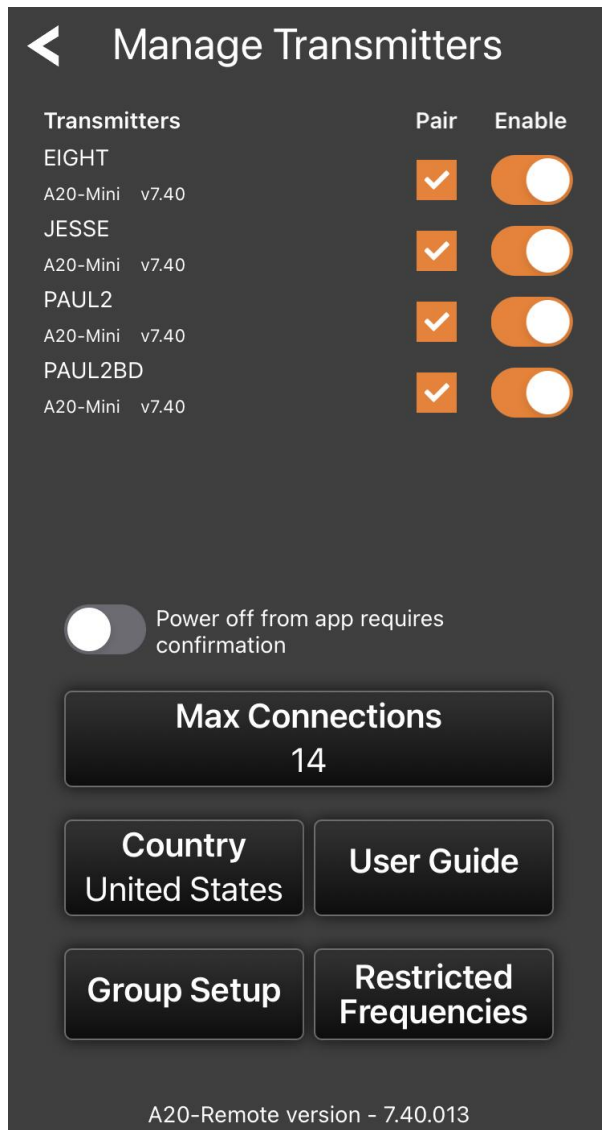

Pairing an A20-Mini with A20-Remote

With A20-Mini off, press and hold the red button until the blue LED blinks continuously. USB must be disconnected from computers to enter Pairing mode. Make sure all instances of A20-Remote are fully closed on other mobile devices before attempting to pair to a new device.

From A20-Remote's Manage Transmitters window, touch the Pair box to add a check mark and pair the A20-Mini to the mobile device. The A20-Mini exits Pairing mode once it has been paired with the mobile device. Agree to the Terms and Conditions displayed in the app to continue.

To unpair/remove an A20-Mini from the mobile device, touch the Pair box to clear the check mark. Once removed, repeat the pairing process to re-add the transmitter.

Enabling A20-Mini Transmitters for control

From the A20-Remote Manage Transmitter window, enable an A20-Mini for control using the Enable switch. Enabled transmitters are added to the Transmitter List and can be controlled from A20-Remote. Disable A20-Mini control if handing control over to another device running A20-Remote or A20-Nexus.

Power off from app requires confirmation

When Power off from app requires confirmation is active, touching the Power button in the Transmitter View displays a confirmation pop up to avoid accidentally powering off an A20-Mini. Deactivate this option when you want the Power button to power off A20-Mini transmitters without confirmation.

Max Connections

All mobile devices have a maximum number of supported Bluetooth devices (smartwatches, headphones etc) that they can connect to simultaneously. The maximum number of simultaneous connections is dependent on iOS/Android hardware and operating system version. When A20-Remote attempts to control A20-Mini transmitters exceeding the maximum number of supported simultaneous connections by the mobile device, there is the potential for communication errors.

The Max Connections setting enables A20-Remote to maintain reliable Bluetooth communication with all transmitters in situations where there are more transmitters than the maximum number allowed by the mobile device. It does this by automatically staggering communication. The top transmitters in the Transmitter List are treated as priority, then communication steps through the remaining transmitters in the list, one at a time. All of this is managed automatically by A20-Remote.

Determining the Max Connections Value:

Start by setting Max Connections to 7.

If A20-Remote is able to simultaneously connect to 7 transmitters, then try setting to a higher Max Connections value.

If A20-Remote is unable to simultaneously connect to 7 transmitters, the following warning is displayed:

Connection Failed
 [A20-Mini name] failed to connect.
 Consider reducing Max Connections to 6

Reduce Max Connections to 6. If the 'Connection Failed' warning keeps being displayed, then decrease Max Connections until the warning no longer appears.

A transmitter has an active simultaneous connection if a dot is displayed between the transmitter's Bluetooth symbol and signal strength meter.



The maximum number of available connections is dependent on all Bluetooth devices currently connected to the smartphone/tablet. For this reason, it may be necessary to change Max Connections from time to time and/or disconnect other bluetooth devices (such as watches, headphones, smart speakers etc) not currently in use.

Country

Country is automatically set by Location Services of the mobile device. The Country setting determines available Frequencies and RF Power options. It is the users responsibility to operate on allowed frequencies in their region. Make sure to set A20-Nexus and A20-RX receivers to the same country as the A20-Mini transmitters.

Group Setup

Enters the Group Setup menu. See Group Control for more information.

User Guide

Touch to visit Sound Devices website with quick links to the A20-Mini User Guide, FAQ, and tutorial videos.

Restricted Frequencies

The wireless system operator needs to be aware of local regulations and comply with all applicable laws regarding operation of wireless devices.

The Manage Restricted Frequencies menu allows the unlocking of restricted frequencies that require proof of a valid license before they can be used. Once a license has been granted, please contact Sound Devices (RF_Request@SoundDevices.com) to obtain the necessary unlock code. The license will be applied to the unique device ID provided to Sound Devices. Tap the Check for Licenses button or manually enter the License Code to unlock the restricted frequencies.

An example of a frequency band requiring an unlock code in the United States is 1435-1525 MHz. Program Making and Special Events (PMSE) wireless operators typically call 1435-1525 MHz the "AFTRCC band". AFTRCC stands for Aerospace and Flight Test Radio Coordinating Council. This organization coordinates a number of frequency bands for use by air and spacecraft in the United States. This includes 1435-1525 MHz.

Per the United States Federal Communications Commission (FCC) rules, Wireless microphones are allowed as secondary users in the 1435-1525 MHz AFTRCC band. This is detailed in the FCC Part 74 rules:

<https://www.ecfr.gov/current/title-47/chapter-I/subchapter-C/part-74>

One section of the Part 74 rules that's of particular interest to operators seeking an AFTRCC band license is 74.803(d):

[https://www.ecfr.gov/current/title-47/chapter-I/subchapter-C/part-74#p-74.803\(d\)](https://www.ecfr.gov/current/title-47/chapter-I/subchapter-C/part-74#p-74.803(d))

Similar to the 914.5 - 944 MHz band, nationwide licenses are not typically granted for wireless operation in 1435-1525 MHz.

Generally speaking, a wireless operator needs to show they've used all other available spectrum before the AFTRCC will consider a license request in the 1435-1525 MHz range. If granted, the license is normally assigned for a specific location and a specific time range.

Sound Devices encourages all wireless operators to obtain a Part 74 license, and specifically to make sure applicable parts of the 600 MHz and 950 MHz range are included with their license application. This can help show an operator is aware of the available spectrum and is utilizing it responsibly.

More information on Part 74 licensing can be found here: <https://www.local695.com/fcc-licensing/>

A20-Remote Version

Displays the current A20-Remote software version.

Transmitter List



The Transmitter List is a scrollable list of Groups and all enabled transmitters.

Groups appear at the top of the Transmitter List. The All Transmitter and custom groups can be removed from the Transmitter List in Group Setup.

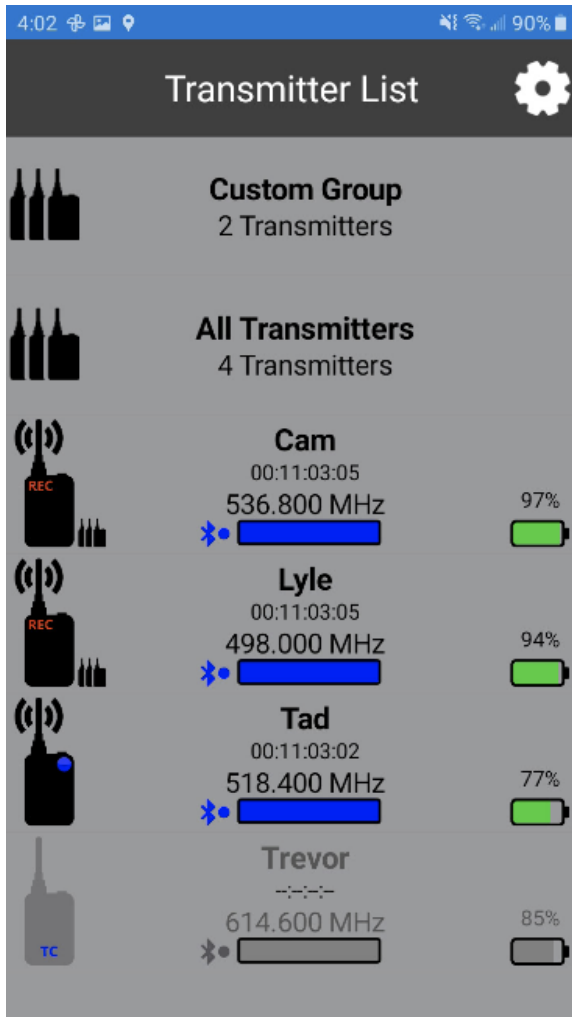
Each transmitter is listed with a high-level view of the transmitter's status. This includes the transmitter's name, set frequency, Bluetooth signal strength meter, the status of battery level/charging, custom Group assignment, and an A20-Mini Status indicator that displays the status of A20-Mini power, audio presence/mute, record, RF transmission, and Identify mode.



A20-Mini Status Indicator

Icon	Description
	<p>A20-Mini On The A20-Mini appears black when it is on.</p>
	<p>A20-Mini Recording The letters "REC" appear in red in the top left corner when the A20-Mini is recording.</p>
	<p>A20-Mini Transmitting RF The A20-Mini appears with RF waves coming from the antenna when it is transmitting RF.</p>
	<p>A20-Mini Audio Presence The A20-Mini appears with a green circle in the top right corner when audio is present.</p>
	<p>A20-Mini Mic Muted The A20-Mini appears with a blue circle in the top right corner when the microphone is muted.</p>
	<p>A20-Mini Recording, Transmitting, Audio The A20-Mini is on, recording, transmitting RF, and audio is present.</p>
	<p>A20-Mini Identify Mode The A20-Mini appears with a flashing 'ID' when the unit is in Identify mode.</p>
	<p>A20-Mini Off The A20-Mini appears gray when it is powered off.</p>
	<p>A20-Mini Off, Holding Timecode The A20-Mini appears gray with "TC" in blue when it is powered off and holding timecode.</p>
	<p>A20-Mini Unknown State The A20-Mini appears with '?' when the status is unknown. This could be displayed because the unit is out of range or the power source has been removed or depleted.</p>

Custom Group Indicator

The Custom Group indicator displays when the A20-Mini is a member of the custom group. See Group Control for more information.





Bluetooth Signal Strength Indicator

Displays the signal strength of the A20-Mini Bluetooth signal received by the mobile device. The Bluetooth meter border is red when the mobile device is not communicating with the A20-Mini. A blue dot appears after the Bluetooth icon when the A20-Mini is connected.



Battery/Power Status Indicator

Icon	Description
	<p>Battery Level Indicator Displays the level of the battery.</p> <ul style="list-style-type: none"> Green = Good Orange = Marginal, about an hour of battery life remaining. Red = Low, 15-20 minutes of battery life remaining. Flashing Red = Critically low, RF, audio, and recording disabled. <p>Remaining battery is displayed directly above the battery icon in percentage for Li-Ion and in voltage for AAA batteries.</p> <p>It is normal to see voltages increase for the first 60-90 minutes when fresh Energizer Lithium primary AAA cells are put under load. This is due to the characteristic of the cells gradually warming up, raising the terminal voltage.</p>
	<p>Battery Charge Indicator Displays the charging status of the battery.</p> <ul style="list-style-type: none"> Orange = Charging Green = Charging complete
	<p>USB Power Displays when USB is powering the A20-Mini and there are no batteries inserted.</p>

Transmitter Name

Displays the name of the A20-Mini. The serial number is the default name of the A20-Mini. The A20-Mini name is changed in the Transmitter View menu.

Transmitter Timecode

Displays the timecode values in hours:minutes:seconds:frames of the connected transmitter. This allows you to quickly see that the connected A20-Mini transmitters are running the same timecode. It is normal to observe a few frames difference between transmitter timecode displays.

If the transmitter is either off or not connected, timecode values are displayed as --:--:--:--. Timecode values are not displayed in RF Only mode.

Transmitter Frequency

Displays the RF frequency on which the A20-Mini is transmitting. The RF frequency can be changed in the Transmitter View menu.

Reordering the Transmitter List

Reorder Transmitter List by pressing and holding an A20-Mini, then dragging it into the desired position. Groups cannot be reordered. Groups can be removed from Transmitter List in the Group Setup menu.

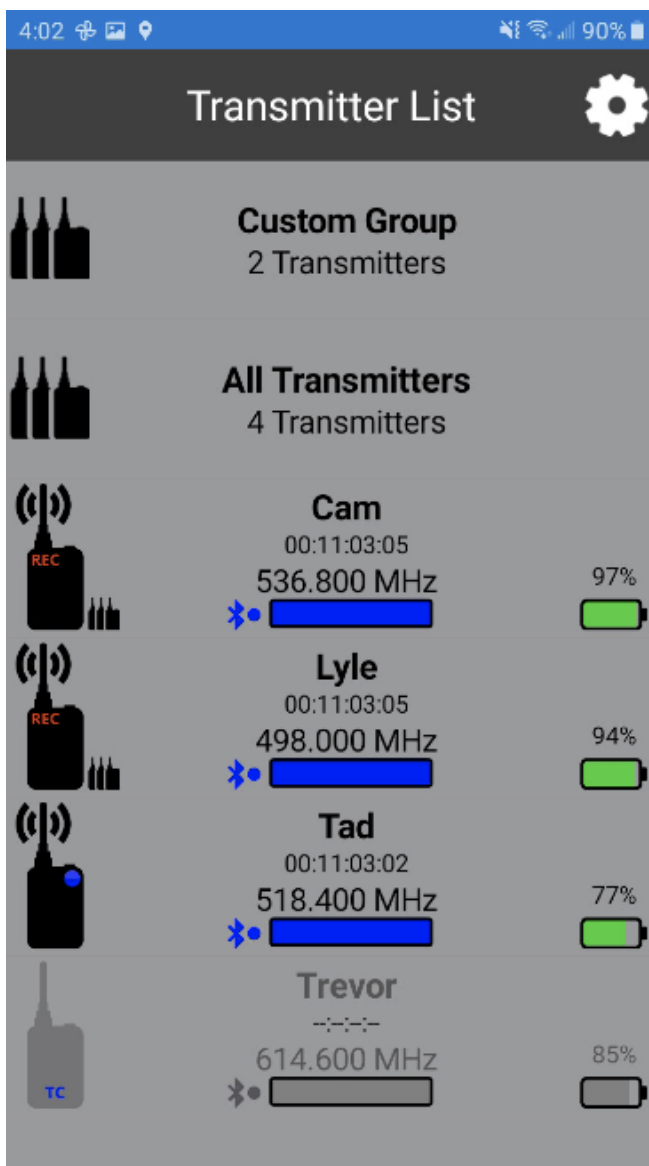

Transmitter View

The Transmitter View displays further details of the active A20-Mini and provides control of functions and menus of the selected transmitter.

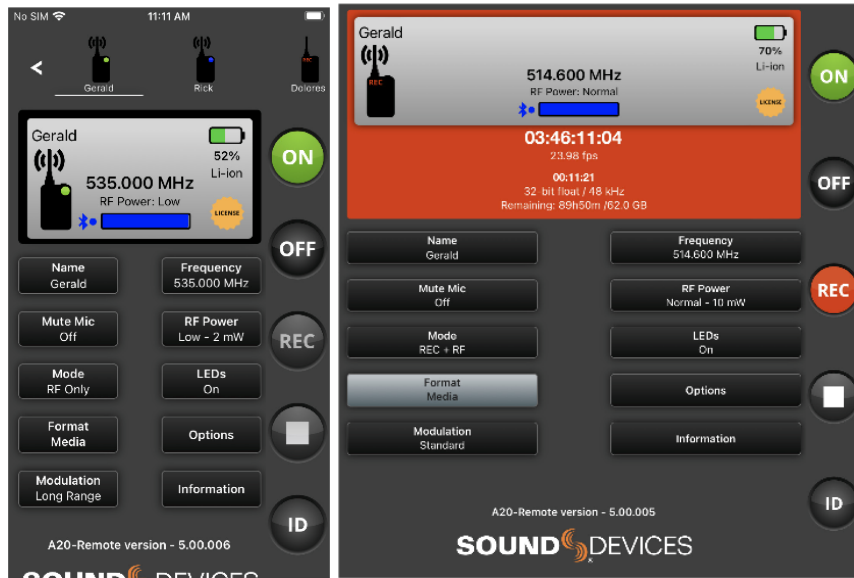

Active A20-Mini in the Transmitter View

The active A20-Mini in the Transmitter View is indicated by the highlighted entry of the Transmitter List. Touch any transmitter in the Transmitter List to make it the active transmitter.

Quick List (Phone Only)

The Transmitter Quick List is available on phones only because the nature of the phone's smaller screen size does not allow the Transmitter List and the Transmitter View to be simultaneously displayed.

The Quick List is a horizontally scrollable list of all enabled transmitters displayed only with the A20-Mini Status indicator and transmitter names. Touch a transmitter in the Quick List to make it the active transmitter in the Transmitter View. Touch the back button to exit back to the Transmitter List.

Transmitter Status Window

The Transmitter Status window displays detailed information of the active transmitter. The A20-Mini Status indicator, Battery /Power status indicator, and Bluetooth Signal Strength meter are described in detail in the Transmitter List section. These indicators are also present in the Transmitter Status window. In addition, the Transmitter Status window shows the active power source and RF Transmission details.

Power Source Details

The active power source is displayed next to the Battery Level meter and battery percentage/voltage.

- AAA is displayed when powering from AAA batteries.
- Li-Ion is displayed when powering from a Li-Ion Sony NP-BX1 battery.
- USB is displayed when powering the A20-Mini from the USB-C connector.

RF Transmission Details

RF Transmission details are displayed when A20-Mini mode is set to RF Only or REC + RF (not available in the U.S.). The set frequency is displayed in MHz and the RF Power setting is listed below.

License Required

Some frequencies may require a license to operate on in your area. The License icon appears as a reminder to the user if the set frequency requires a license for the current Country.



Recording & Timecode Status Window





Recording & Timecode details are displayed when A20-Mini mode is set to REC Only or REC + RF (not available in the U.S.). Timecode values, frame rate, absolute record time counter, file format (32-bit float, 48 kHz), and remaining record time / space of the media. This window is red when the A20-Mini is recording.

Controlling A20-Mini from A20-Remote

From the Transmitter View you can control parameters of the A20-Mini while it is powered on. The A20-Mini continues to communicate with the app when powered off. While off, the A20-Mini settings and timecode are displayed. The A20-Mini can be powered on or put into Identify mode from the app while the A20-Mini is powered off.

Transmitter Controls

The far right-hand side of the Transmitter View provides easy access to Power, Identify mode, Record, and Stop.

Icon	Description
	Transmitter Power On Touch the Power ON button to power the A20-Mini on. The button is black when the transmitter is off and green when on.
	Transmitter Power Off Touch the Power OFF button to power the A20-Mini off. The button is gray when the transmitter is off and black when on. By default a confirmation pop up message appears when powering off the A20-Mini from the app. This can be deactivated in Manage Transmitters by deactivating Power off from app requires confirmation.
	Record Touch the Record button to start a recording on the A20-Mini. The button is red while recording. The button is gray when recording is not permitted.
	Stop Touch the Stop button to stop recording. The button is yellow while recording is stopped. The button is gray when recording is not permitted.
	Identify Mode Touch the Identify button to put the A20-Mini into Identify mode. All LEDs (except the audio LED) on the A20-Mini flash blue making it easy to locate a specific A20-Mini. When Identify mode is active, the Identify button is green and the A20-Mini Status indicator shows "ID" in green text. Touch the Identify button again or press the A20-Mini red button to disable Identify mode. Identify mode is available when the A20-Mini is powered on or off.

Transmitter Menu

The Transmitter Menu is displayed beneath the Transmitter and Record & Timecode Status windows of the Transmitter View. It offers control of the A20-Mini Name, Frequency, Mute Mic, RF Power, Mode, LEDs, Format Media, Options, Modulation, and access to A20-Mini Information.

Naming the A20-Mini

While in the Transmitter View, touch the Name button and use the pop up QWERTY keyboard to rename the transmitter. Up to twelve alpha-numeric characters can be used for the transmitter's name. The serial number of the unit is the name by default. Transmitter names are sent over RF to the A10-RX and are embedded in metadata as the Track Names of recorded WAV files.

Setting Frequency

The A20-Mini transmits on frequencies ranging from 470 MHz – 1525 MHz. The frequencies available are determined by geographic location and whether you have entered a unique license code issued by Sound Devices to unlock the use of restricted frequencies. See Manage Transmitters for more information.

Because the A10 and A20 digital RF transmission is inherently immune to intermodulation, multiple A10 and A20 Digital Wireless transmitters can be used simultaneously on nearby adjacent frequencies without worry of intermodulation interference. Systems can be used together when separated by at least 400 kHz. When operating in the 902-928 MHz Band, it is recommended to separate channel frequencies by at least 1 MHz.

Touch the Frequency button to enter the Frequency menu. From the frequency menu, use the scroll wheels to select a frequency (integer and fractional of MHz) or use the +400 kHz and -400 kHz buttons. Touch the Set Frequency button to set the frequency and exit back to the Transmitter View.

After changing frequency, attach an antenna with a length specific to the frequency in use. Using the wrong length of antenna reduces RF range. The recommended antenna for the set frequency is displayed in the Information menu. See Antenna Guide for more information.

Setting RF Power

RF power is the strength of the transmitting signal. The A20-Mini offers the following RF power settings.

- Off - A20-Mini is not transmitting RF.
- Low - 2 mW
- Normal - 10 mW
- High - 20 mW
- *Extra High - 40 mW. This setting only appears when Options>Allow Extra High - 40 mW RF Power is active.

RF Power settings are based on the selected Country of the device running A20-Remote as some legal restrictions may apply. Touch the RF Power button and make a selection from the list.

In situations where the transmitter is relatively close to the receiver, the Low - 2 mW setting offers the best battery life. For most common wireless microphone applications, the Normal - 10 mW setting provides excellent range. In situations where body absorption may be an issue or extended range is required, the High - 20 mW setting can be helpful.

If significant body absorption is unavoidable or maximum range is required, the Extra High - 40 mW setting can be enabled via the settings menu. Please be aware that the Extra High - 40 mW RF Power setting can reduce battery life by over 20%.

Tip: Try using Long Range Modulation to increase RF range prior to increasing the RF Power setting.

Mode

Touch the Mode button to enter the Mode menu. Select between RF Only, REC Only, and REC + RF.

Simultaneous Record and Transmit mode is not available on A20-Mini units sold or operated in the United States of America.

Record & Timecode details are not displayed in the TX Status Window when RF Only is selected. RF Transmission details are not displayed in the Transmitter Status window when REC Only is selected.

Mute Mic

Touch the Mute Mic button to mute the microphone. When muted, no audio is present in the recordings or transmitted. Mute status is indicated by a blue Mute Mic menu button, a blue dot in the A20-Mini Status indicator, and the A20-Mini Audio LED turns solid blue.

LEDs

The A20-Mini LEDs can be turned on or off. Turn the LEDs off when you need the A20-Mini to be discreet. When Off, the LEDs do not illuminate except when pressing the red button to power on, power off, or pair, in Identify mode, and when USB-C is connected.

Formatting Media

Formatting the A20-Mini media deletes all recorded files. It is good practice to periodically format media. Make certain to transfer any files before formatting. The first eleven characters of the transmitter name are used to name the media. Media is named at time of format.

Modulation

Select Standard or Long Range Modulation. When compared to Standard Modulation, Long Range Modulation has better sensitivity. This increased sensitivity results in more robust performance in challenging RF environments.

The Modulation setting must match between the A20-Mini and the A10-RX in order for the transmitted signal to be received.

Information

Displays the recommended antenna and TV Channel of the current set frequency, version of A20-Mini firmware, A20-Mini serial number, and compliance documentation for local government requirements if applicable.

Options

The Options menu provides access to a sub-menu of less frequently changed settings.

- Power on when removed from PowerStation-8M
- Power on with Lav mic connection
- Resume record state upon power on
- Allow Extra High - 40 mW RF Power
- Battery Type
- Restore Defaults

Auto Power On When Removed from the PowerStation-8M

The A20-Mini automatically powers off when connected to a charging bay of the PowerStation-8M. To save time from having to manually power on the A20-Mini, activate the Power On When Removed from the PowerStation-8M feature. When active, removing the A20-Mini from the PowerStation-8M powers the transmitter on. This feature can be turned on or off. See PowerStation-8M for more details.

Auto Power with Lav Mic Connection

The A20-Mini can auto-detect the presence of a lavalier microphone connection and power on and off accordingly. When Auto Power with Lav Mic Connection is active, connecting a lavalier microphone to the A20-Mini automatically powers on the transmitter. Removing the lavalier mic connection automatically powers the A20-Mini off. This feature can be turned on or off.

Resume Record State Upon Powering On

The A20-Mini by default powers on in Stop mode. When Resume Record State Upon Powering On is active, the A20-Mini resumes the state of the recorder when it was powered off. This menu item is not available when in RF Only mode.

Allow Extra High - 40 mW RF Power

Activate this option when you want the Extra High - 40 mW setting available in the RF Power menu. See RF Power for more information.

Battery Type

To ensure accurate battery remaining power indication, set this option to 'Battery Doubler' when using the A20-BatteryDoubler accessory.

Restore Defaults

Touch the Restore Defaults button to restore default settings.

- Name = Serial Number
- Frequency = Lowest frequency allowed in current Country
- Mode = REC + RF (International), RF Only (United States)
- LEDs = On
- RF Power = Normal - 10 mW
- Mute Mic = Off
- Modulation = Standard
- Power on when removed from PowerStation-8M = Off
- Auto power with lav mic connection = On
- Resume record state upon powering on = Off
- Allow Extra High - 40 mW RF Power = Off
- Recording = Stopped
- Timecode = 00:00:00:00
- Frame Rate = 30 fps
- Identify mode = Off
- Power = On

Group Control

Multiple A20-Mini transmitters can be controlled as a group from the A20-Remote app. Group Control drastically simplifies the workflow and saves time when changing powering and record status of multiple A20-Mini transmitters.

Two groups are available, All Transmitters group for controlling all enabled transmitters and a custom group for controlling select group of transmitters.

Groups appear at the top of the Transmitter List. When selected, the Group View is displayed. The Group view displays the status of all transmitters in the group and provides group control of the following functions.

- Power On
- Power Off
- Record
- Stop



Group Setup

Navigate to Manage Transmitters>Group Setup to change group options and create a custom group.

Show “All Transmitters” Group in the Transmitter List

When active, the All Transmitters group is displayed and accessible from the Transmitter List. Deactivate to remove the All Transmitters group from the Transmitter List.

Show Custom Group in the Transmitter List

When active, the custom group is displayed and accessible from the Transmitter List. Deactivate to remove the custom group from the Transmitter List.

Custom Group Name

Touch the text box and use the pop up QWERTY keyboard to rename the custom group. Up to twelve alpha-numeric characters can be used for the custom group name. Custom Group is the name by default.

Assigning A20-Mini Transmitters to the Custom Group

All A20-Mini transmitters paired to the A20-Remote application are displayed in the Group Setup list. Touch the Group check box to assign or unassign an A20-Mini to the custom group.

Use the Select All check box to assign or unassign all paired transmitters to the custom group. A20-Mini transmitters assigned to the custom group appear with a Custom Group Indicator in the Transmitter List and Transmitter view.

Selecting a Group from the Transmitter List

Groups appear at the top of the Transmitter List. Groups are shown with the number of available transmitters in the group. Touch a group to enter the Group View.

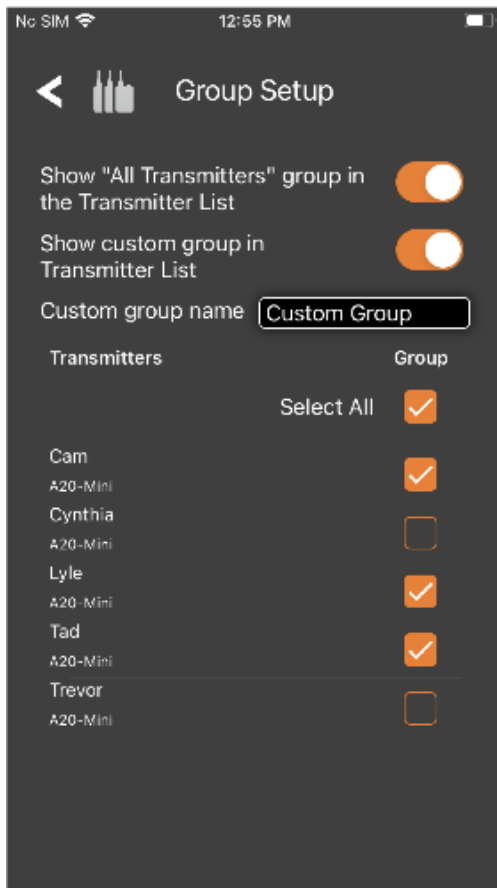

Group View

The Group View displays a scrollable list of all available A20-Mini transmitters in the group. Transmitters are displayed with the same information shown in the Transmitter List. Touching a transmitter accesses the A20-Mini’s Transmitter View.

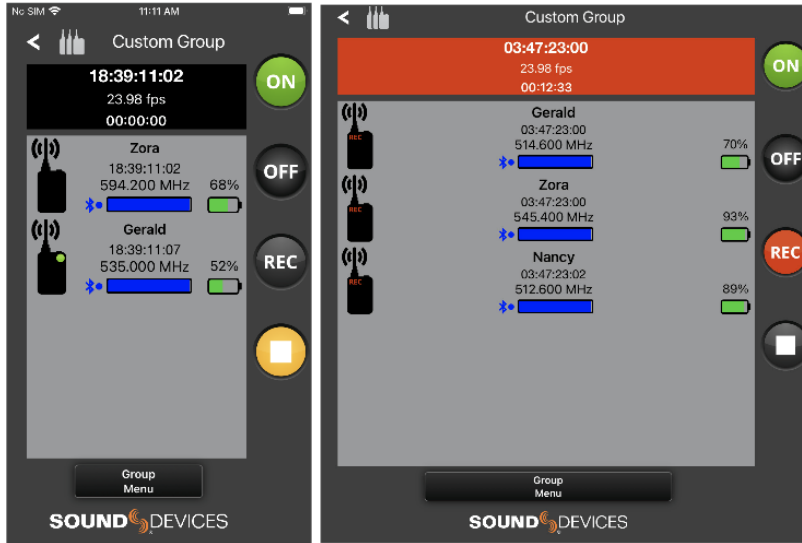

The Recording and Timecode window displays timecode, frame rate, and an absolute record time counter. The window is red when recording and black when stopped. This window is not displayed in RF Only mode. The first transmitter of the group list is used to display the details of the Recording and Timecode window.

Controlling a Group of A20-Mini Transmitters

Touch any button in the Group View to apply the function to all available transmitters in the group.

Icon	Description
	Group Power On Touch the Group Power ON button to power on the group of transmitters. The button is black when the transmitters are off and green when on.
	Group Power Off Touch the Group Power OFF button to power off the group of transmitters. The button is gray when the group is off and black when on. By default a confirmation pop up message appears when powering off A20-Mini transmitters from the app. This can be deactivated in Manage Transmitters by deactivating Power off from app requires confirmation.
	Group Record Touch the Group Record button to start recording on the group of A20-Mini transmitters. The button is red while the group is recording and black when stopped. The button is gray when recording is not permitted.
	Group Stop Touch the Group Stop button to stop recording on the group of A20-Mini transmitters. The button is yellow while stopped and black when recording. The button is gray when recording is not permitted.
	Partial Partial is displayed in between the ON and OFF buttons and in between the Record and Stop buttons when there is a discrepancy between transmitters in the group. For example, if the group is powered on and an individual A20-Mini is then powered off, "Partial" flashes between the ON and OFF buttons.

Group Status Screen

A Group Status screen appears while A20-Remote is sending commands to transmitters in the group. The status of the command sent is displayed for each A20-Mini in the group. The status text is green while sending the command, white when successful, and red if the A20-Mini was unable to accept the command.

Touch the Cancel button to abort the group command. Canceling a command does not revert any changes already applied and may result with the group in a “Partial” state.

Group Menu

The Group Menu allows you to set Mute, RF Power, Mode, LEDs, Modulation, and Format Media for all transmitters in the group. Partial is displayed in the menu button when transmitters in the group have different settings.

Touch the Group List button to return to the Group View.



Connecting Lavalier Microphones to A20-Mini

Connect a 2- or 3-wire lavalier microphone to the A20-Mini transmitter's 3-Pin LEMO connector. Lock the connection by turning clockwise until the connector is firmly attached to the A20-Mini.

The AC-BALXLR-4 3-pin LEMO to XLR female cable is not compatible with the A20-Mini as it does not have a balanced-input mode/microphone preamplifier.

Source Type	A10-TX	A20-Mini
2-wire lav	Yes	Yes
3-wire lav	--	Yes
Balanced mic XLR	Yes	--
Balanced line XLR	Yes	--
Auto-power-on w/ lav	--	Yes

Tuning A20-Mini and the Receiver

RF signals transmitted by the A20-Mini transmitter are received by the Sound Devices A20-Nexus, A20-RX and Audio Ltd A10-RX. Set the same modulation and frequency on the transmitter and receiver. See the A20-Nexus, A20-RX and A10-RX User Guides for more details.

GainForward

The A20-Mini transmitter introduces GainForward, a new feature that eliminates the need to adjust microphone preamplifier gain at the wireless transmitter. Audio levels from the transmitter are controlled either directly at the mixer's trim control or at the wireless receiver. If the talent speaks too softly or emotes too loudly after being "wired" with the transmitter, simply adjust the transmitter gain with the mixer's gain trim. Read more about GainForward at:

<https://www.sounddevices.com/gainforward-explained/>

Adjusting Audio of the A20-Mini Signal from the A20-RX and A10-RX Receiver

From the A20-RX or A10-RX home screen, press the channel's arrow button twice to enter the Input menu. From the Input menu, press the middle button to select a sub-menu to adjust gain, low cut, or limiter of the incoming A20-Mini transmitted signal.

Gain is adjustable from 0 to 60 dB. Low cut can be set to Off, 40 Hz, 60 Hz, 80 Hz, 100 Hz, or 200 Hz. Limiter can be turned on or off. The information menu displays the status of the tuned A20-Mini. See the A20-RX or A10-RX User Guides for more details.

Adjusting Audio of the A20-Mini Signal from the A20-Nexus Receiver

See the A20-Nexus User Guide for details.

Adjusting Audio of the A20-Mini Signal from the 8-Series or 688

When the A20-RX or A10-RX receiving A20-Mini signal is slotted into the SL-2 or SL-6, the A20-RX or A10-RX Input menu settings are bypassed and all gain, low cut, and limiter activity are performed and controlled by the 688, 833, 888, or Scorpio. This is also the case when using an A20-Nexus docked to an 8-Series. See the Mixer-Recorder User Guides for more information.

Recording WAV Files

The A20-Mini records 32-bit float Broadcast WAV (under 4 GB) or RF64 WAV (over 4 GB) files at 48 kHz sampling rates. 32-bit float files are recorded such that gain decisions can be made after recording. Because of the high dynamic range of the A20-Mini audio levels are never too high or too low. Learn more about 32-bit float at:

<https://www.sounddevices.com/a20-mini-32-bit-float-recording>

A20-Mini recordings are started and stopped using the record and stop buttons in the A20-Remote Transmitter View.

The file name format is

transmitter name-YYMMDDHHMMSS.WAV.

For example, if the A20-Mini name has been changed to “Barney” and a recording is created on July 10, 2021 at 09:30 (24 hour format), the resulting file is named Barney-210710093000.WAV. All files are recorded at root of the media (no folders).

Jamming Timecode on A20-Mini

The A20-Mini accepts timecode from external LTC sources. The timecode value and frame rate are taken from incoming LTC source. If timecode has not been jammed, the A20-Mini starts rolling timecode from 00:00:00:00 when it is powered on.

Jammed timecode values are held for up to four hours after powering off, and up to one hour after the battery has been removed. This allows for time to swap batteries without having to re-jam timecode.

To jam timecode, connect a valid LTC source using one of the optional accessories, Sound Devices XL-TC-USBC-LEMO or XL-TC-USBC-BNC, to the A20-Mini USB-C port. Timecode is automatically jammed once a valid LTC source is connected. After a successful timecode jam, the Audio/LTC LED flashes blue on the 00 frame crossing.

Timecode is output from the USB-C using the Sound Devices XL-TCU-LEMO, so that you can verify the A20-Mini timecode is in sync with the LTC source. The Audio/LTC LED stops flashing blue when USB-C is disconnected.

For more information about the A20-Mini timecode accessory cables visit:

<https://www.sounddevices.com/product/xl-tc-usbc-bnc/>

<https://www.sounddevices.com/product/xl-tc-usbc-lemo/>

A20-Mini can also jam timecode from 8-Series Mixer-Recorders using a standard USB-C to USB-A cable. Connect the A20-Mini to the 8-Series USB-A port. Enter the 8-Series Menu>Timecode/Sync>Jam A20-Mini then select Jam A20. The 8-Series Jam A20-Mini menu displays the current timecode frame rate and values for the 8-Series and A20-Mini and displays the difference between the two units.

When the A20-Mini is powered off, the Audio/LTC LED and the Charge & Timecode LED flash blue on the 00 frame crossing to indicate timecode is being held.

The A20-Mini can also receive and jam timecode while connected to the optional PowerStation-8M via USB-C. See PowerStation-8M for more details.

	A10-TX	A20-Mini	Cables
LTC via Lemo-3	Yes	--	AC-TCBNC-IN
AC-TCBNC-OUT AC-TCLEMO™ LTC via USB-C	--	Yes	XL-TC-USBC-LEMO XL-TC-USBC-BNC
Timecode jam via USB-A on 8-Series	--	Yes	Standard USB-C to USB-A
Mass Timecode jam via PowerStation-8M	--	Yes	BNC

File Transfer to a Computer

The A20-Mini connects via USB-C to a computer as an exFAT-formatted mass storage device. Copy WAV files from the A20-Mini to the computer. When file transfer is complete, eject the drive from the operating system and disconnect USB.

Recording must be stopped on the A20-Mini before connecting to the computer. While connected to a computer RF transmission, audio, and recording are disabled.

Up to eight A20-Mini transmitters can be connected to a computer for file transfer using the optional PowerStation-8M. See PowerStation-8M for more details.

Updating A20-Mini Firmware

Register your A20-Mini to stay informed of firmware updates. <https://my.sounddevices.com/>

To update your A20-Mini firmware:

1. Connect the A20-Mini to the computer for file transfer using a USB-C cable or the PowerStation-8M. See File Transfer and PowerStation-8M for more information.
2. Download the A20-Mini firmware PRG file from:
<https://www.sounddevices.com/download/?prod=a20-mini>
3. Copy the PRG file to the root of the A20-Mini media.
4. Eject the A20-Mini from the computer.

At this point, the LEDs “dance” to indicate the firmware update is in progress. The firmware update can take a few minutes to complete. Wait for all LED activity to stop before using or powering off the A20-Mini.

When the firmware update completes, the A20-Mini automatically deletes the PRG file from the media. Firmware version information is displayed in A20-Remote Manage Transmitter view and in the Transmitter View Information menu.

SD-Utility

Sound Devices SD-Utility is a companion application for MacOS and Windows. This application can be used to process files recorded by the A20-Mini to be more suited to the given workflow. A20-Mini 32-bit float, 48 kHz, monophonic WAV and RF64 WAV files can be renamed, snipped by timecode values, converted to 24 bit, conformed to a CSV Sound Report, exported as monophonic or polyphonic WAV, and more.



SD-Utility is also a companion application for the Audio Ltd A10-TX, A10-RX, and A20-RX. For details specific to those products, please refer to their respective user guides.

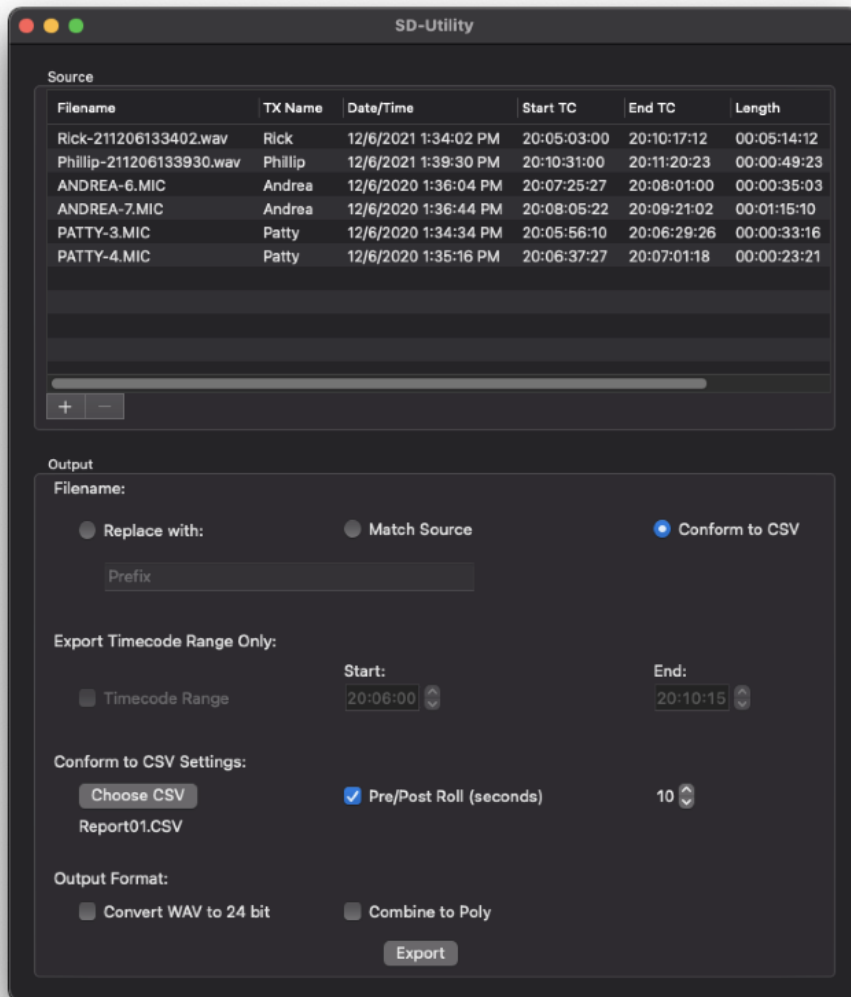

Installing SD-Utility

Download the SD-Utility Installer for MacOS or Windows from:

<https://www.sounddevices.com/download/?prod=sd-utility>

Open the installer and install the application by following the on-screen instructions.

Minimum operating requirements:

MacOS 10.11+, 64-bit

Windows 10+, 64-bit

Importing A20-Mini WAV Files into SD-Utility

SD-Utility accepts monophonic WAV and RF64 WAV files recorded by the A20-Mini or MIC files recorded by the Audio Ltd A10-TX. There are three methods for importing files into SD-Utility.

Drag-and-drop WAV files or volumes/folders containing WAV files into the Source window.

Navigate File > Add and select WAV file(s) for import.

On the bottom left of the Source window, click + in Mac or Add in Windows, then select file(s) for import.

The Source window displays the following information for all imported files.

- Filename
- Transmitter name
- Date and time of file creation
- Start timecode
- End timecode
- Length of recording
- Frame Rate

Removing WAV files from the Source Window

There are three methods for removing WAV files from the Source window.

1. Highlight the WAV file(s) to be removed from the Source window, then click - on Mac or Remove on Windows.
2. Highlight the WAV file(s) to be removed from the Source window, then navigate File > Remove.
3. Highlight the WAV file(s) to be removed from the Source window, then press the Delete key.

Organizing Source Files

Click on a Information Header cell to order the list of files in the Source Window by information. For example, click the Start TC cell to arrange the files by timecode start times from lowest to highest. Click again to reverse the order from highest to lowest.

To manually order the list of source files, click and hold a file row and drag it into the desired position.

Selecting Files to Export

Highlight the file(s) to process and export from the Source window. Multiple files can be selected using keyboard modifiers, Apple and Shift in MacOS, Ctrl and Shift in Windows. If no files are selected, processing is applied to all files in the Source window.

Naming of Processed WAV Files

Processed WAV files will be named according to the Filename selection.

- **Match Source** uses the source file's name in the processed WAV file.
- **Replace with** allows the processed file to be named based on the custom entry.
- **Conform to CSV** uses the take information from a CSV Sound Report to determine the processed file names. See [Conforming A20-Mini WAV Files to CSV sound reports](#).

Creating Shorter WAV Files Based on Timecode Range

When a shorter WAV file is needed than the original recording, you can use the Timecode Range feature to create a shorter WAV file. The length and content of the exported file is based on the entered timecode start and stop times.

1. Highlight the source file(s) from the Source window.
2. Select the Timecode Range check box.
3. Enter valid timecode start and end times. The values must fall within the range of the source file.
4. Select Export.

Conforming A20-Mini WAV Files to CSV Sound Reports

CSV sound report files generated by Sound Devices recorders can be used to extract only relevant audio from the A20-Mini WAV or A10-TX MIC files. Audio is extracted and a new WAV file is created based on the timecode in/out values of takes listed within the CSV.

The exported WAV file names and embedded metadata are changed to match the filenames and metadata of the corresponding takes in the CSV sound report.

Adding Pre- and Post-Roll to conformed files can benefit post production with access to audio just prior to and following head and tail slates. To add pre- and post-roll to conformed WAV files, select the Pre/Post Roll check box and enter a value from 0 to 10 seconds in 1 second steps.

If the source file does not contain audio data for the duration of the pre- or post-roll location, the exported file will begin and end at the closest point to the pre- and post-roll location where audio data is present.

Selecting Bit Depth of Exported WAV Files

The A20-Mini records 32-bit float WAV files. To convert the WAV files to 24-bit integer, select the Convert WAV to 24 bit check box. Files that contain audio that exceeds 0 dBFS will be normalized to -0.1 dBFS to avoid clipping when exported as 24-bit.

Combining to Poly

Combine to Poly allows for the export of a single polyphonic WAV file containing audio tracks from each relevant transmitter for takes of the CSV Sound Report or a select timecode range.

Select the Combine to Poly check box to export a polyphonic WAV file, leave unchecked to export monophonic WAV files for each transmitter.

Combine to Poly is available with the following setups:

- Conform to CSV is selected
- Replace with: and Timecode Range are selected

The interleave order of the polyphonic WAV tracks are determined by the order of the files in the Source Window. Silence is written to a track of the exported polyphonic WAV file whenever audio data is not available from the source files.

A20-BatteryDoubler

The A20-BatteryDoubler dual-battery adapter for the A20-Mini is an optional accessory that doubles the A20-Mini's run time by using two NP-BX1 batteries. With the BatteryDoubler fitted, the A20-Mini's height and width are unchanged; only its depth is increased. Both batteries can be charged simultaneously when the A20-Mini is connected to a USB-C power source.

Swapping the A20-BatteryDoubler with the A20-Mini battery door

The A20-BatteryDoubler and standard A20-Mini battery door can be easily and quickly swapped back and forth by using the 1.4mm screwdriver that comes with the A20-BatteryDoubler.

1. Open the A20-Mini battery door by sliding the A20-Mini door latch to the left.
2. Using the 1.4 mm included screwdriver, unscrew the hinge pin cap screw from the right side of the A20-Mini.
3. From the right, push out the hinge pin and remove. Put the A20-Mini battery door safely to one side.
4. Align the A20-BatteryDoubler door with the A20-Mini and insert the hinge pin all the way through.
5. Screw in the hinge pin cap screw until snug. Do not over tighten.

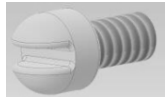

Hinge Pin Cap Screw

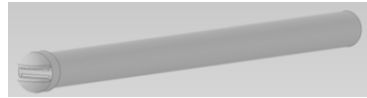

Hinge Pin



Opening the BatteryDoubler Door

To open the A20-BatteryDoubler door:

1. Slide the A20-Mini door latch to the left to unlock the battery door.
2. Lift the battery door using the indented space on the bottom right-hand side of the battery door.

Closing the Battery Door

To close the A20-BatteryDoubler door:

1. Slide and hold the door latch to the left.
2. Close the battery door.
3. Release the door latch to lock the battery door.

Powering from the A20-BatteryDoubler

To power the A20-Mini using two Sony NP-BX1 Li-Ion batteries:

1. Open the A20-BatteryDoubler door.
2. Insert one Sony NP-BX1 Li-Ion into the A20-Mini battery compartment, taking care to place the batteries in the correct orientation.
3. Insert the second Sony NP-BX1 battery into the A20-BatteryDoubler door so that the NP-BX1 battery terminals mate with the BatteryDoubler's contact pins. The door is designed to prevent the NP-BX1 from being inserted the wrong way.
4. Close the A20-BatteryDoubler door.
5. The A20-Mini is ready for turning on.

Setting the Battery Type in A20-Remote

To ensure accurate battery remaining power indication in the A20-Remote app when using the A20-BatteryDoubler:

1. Set Battery Type to 'Battery Doubler' in the A20-Remote app >Transmitter View > Options menu.
2. Always start with two fully charged Sony NP-BX1. If one is more discharged than the other, remaining indication will not be accurate..

PowerStation-8M

The PowerStation-8M Eight Slot Charger for A20-Mini is an optional accessory. It offers battery charging, A20-Mini timecode jamming, and USB file transfer to and from a computer for up to eight A20-Mini transmitters or four A20-Mini transmitters fitted with the A20-BatteryDoubler.

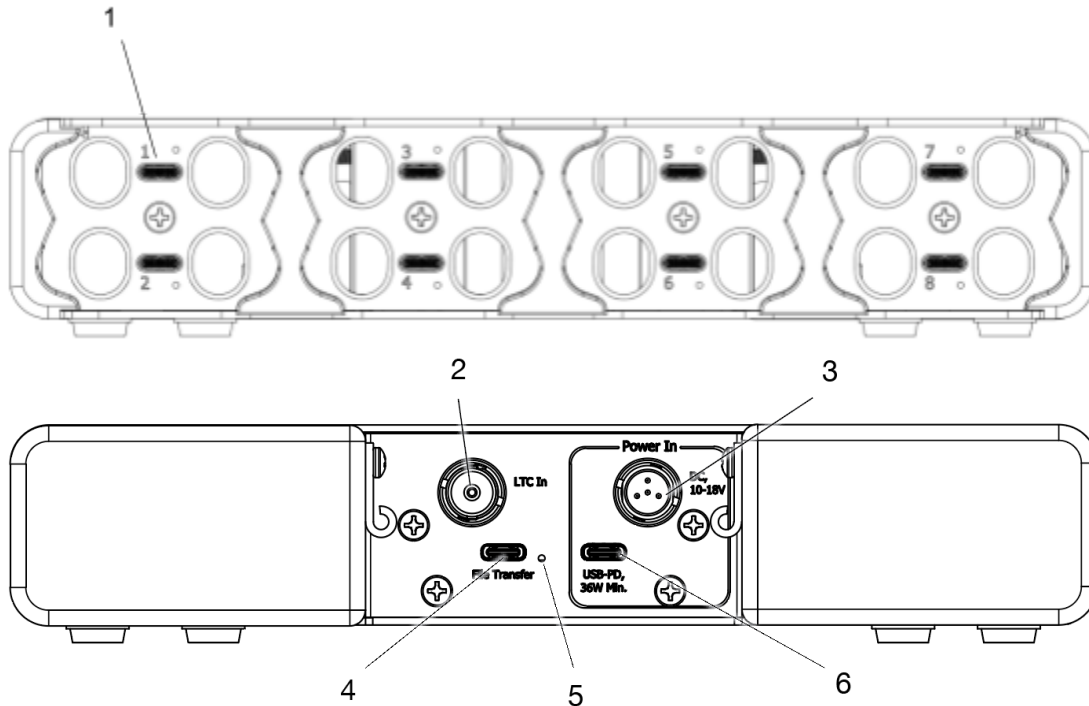

- 1: Charging Bay**
- 2: BNC LTC Input**
- 3: TA-4 10-18 Volt DC Input**
- 4: USB-C for File Transfer**
- 5: File Transfer Status LED**
- 6: USB-PD Power Input**

Charging Batteries from the PowerStation-8M

Enabled charging bays are indicated by LEDs within each charging bay. If a TA-4 or USB-PD with proper rating is used, all eight charging bay LEDs illuminate. If a USB adapter is used which does not supply sufficient power, then only three of the charging bay LEDs will illuminate.

The PowerStation-8M only charges Sony NP-BX1 batteries within an A20-Mini. AAA battery charging is not supported. Inserting A20-Minis with AAA batteries into the charging bay will not damage anything, but the unit will not charge.

Insert the A20-Mini into an enabled charging bay of the PowerStation-8M. The A20-Mini slides into a charging bay with the antenna-side first, the antenna may be left attached. Sound Devices recommends disconnecting lavalier microphones before inserting the A20-Mini into the charging bay.

Charging status is indicated by the A20-Remote application and the A20-Mini bottom panel Charge LED.

- Solid Orange = Charging
- Solid Green = Charging complete
- Off = Not charging

A20-Mini transmitters are powered off when inserted into a charging bay. The A20-Mini powers on when removed from the charging bay if 'Power On When Removed from PowerStation-8M' is active.

Bottom Panel 1/4"-20 Mounting Point (not pictured)

The PowerStation-8M offers a 1/4"-20 mounting point on the bottom panel for securely attaching to a rack shelf, such as the Pyle 1U Server Rack Shelf Mount Tray PLRSTN14U.
<https://pyleusa.com/products/plrstn14u>

Powering the PowerStation-8M

The PowerStation-8M is powered via 12 VDC TA-4 connector or USB-PD power supply. The supplied 36 W USB-PD power supply supports full operation. Make certain third-party USB-C power supplies offer 36 W or higher in order to charge all eight A20-Mini transmitters at a time. Make certain any external supply connected to the TA-4 connector supplies at least 36 W.

Distributing Timecode to A20-Mini Transmitters

The PowerStation-8M is equipped with a Timecode input on BNC. Connecting a valid LTC timecode source to the PowerStation-8M jams the frame rate and timecode value to all inserted A20-Mini transmitters. The A20-Mini bottom panel Timecode LED flashes blue on the 00 frame following a successful jam.

Transferring A20-Mini Files via PowerStation-8M

The File Transfer USB-C connector is used to connect A20-Mini transmitters slotted into the PowerStation-8M to a computer as mass storage devices. Each connected A20-Mini transmitter will appear as its own mass storage device when the PowerStation-8M is connected to a computer. The PowerStation-8M USB-C connector is SuperSpeed USB (5 Gb/s) offering maximum transfer speeds when all eight slots are filled.

The File Transfer LED lights red when USB-C File Transfer is plugged in without a power adapter connected. The File Transfer LED lights green when USB-C File Transfer and either TA-4 or USB-PD are plugged in.

See File Transfer to a Computer for more information.

Updating A20-Mini Firmware via PowerStation-8M

Using File Transfer in combination with the PowerStation-8M, Firmware can be updated on up to eight A20-Mini transmitters.

PowerStation-8M A20-Mini Extraction Tool

The PowerStation-8M ships with an A20-Mini Extraction tool for easy removal of A20-Mini transmitters from PowerStation-8M charging bays. When multiple A20-Mini transmitters are in the charging bays, the Extraction tool provides more finger room.

The Extraction tool comes with an 18-inch steel lanyard for securing it to a rack. The lanyard can be removed by sliding the loop end of the lanyard over the center pillar of the extraction tool.

For safe keeping, insert the A20-Mini Extraction tool handle side first while pinching into an empty charging bay.

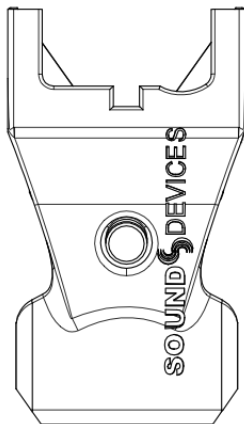

Removing A20-Mini from PowerStation-8M with the A20-Mini Extraction Tool

Align the Sound Devices logos of the Extraction tool and the A20-Mini battery door, then slide Extraction tool onto the A20-Mini until you hear a click. Pull the A20-Mini out of the slot. Pinch the handle to release the A20-Mini from the Extraction tool.

PowerStation-8M Specifications

Specifications are subject to change without prior notice. For the latest information available on all Sound Devices products, visit our website: www.sounddevices.com.

Power

- USB-C: PD (Power Delivery), 36 W or higher, or
- TA-4: 10 - 18 VDC, 36 W or higher
- Pin-4 hot, pin-1 ground, pin-2 and pin-3 data for smart batteries. Leave pins-2 and pin-3 disconnected if not using smart batteries.

LTC Input

- Input impedance: 5k ohm
- Signal level: 0.3 - 5 Vp-p

USB-C

- USB 3.0 SuperSpeed, internal hub

Dimensions (HxWxD)

- 40 mm x 220 mm x 136 mm (without feet)
- 1.58 in x 8.66 in x 5.35 in (without feet)

Weight

- 670 g
- 1.5 lb

Included Accessories

- Power Supply
- 2x USB-C to USB-C Cables, USB 3.0

A20-Mini Specifications

Specifications are subject to change without prior notice. For the latest information available on all Sound Devices products, visit our website: www.sounddevices.com.

Frequency Range

- 470 to 1525 MHz
- Transmitters are tunable in 25 kHz steps
- Available frequencies are dependent on region

RF Output Power

- Off, Low - 2 mW, Normal - 10 mW, High - 20 mW, Max -40 mW, selectable

Modulation Mode

- Proprietary, 100% digital RF modulation
- Standard or Long Range, selectable

Antennas

- UHF RF: SMA connector, removable
- 2.4 GHz built-in

Audio Frequency Response

- 10 Hz - 20 kHz, +/- 1 dB re 1 kHz

Audio Input Type

- Lavalier Microphone via 3-pin LEMO
- Pin-1 ground
- Pin-2 5 V bias
- Pin-3 audio/bias (8k ohm to 5 V)

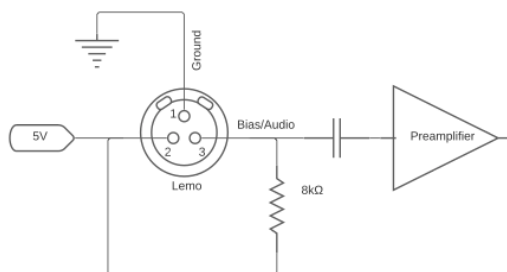

Bias Power

- 5 V

Input Impedance

- 8k ohms

Input Clipping Level

- +5 dBu

Dynamic range

- 130 dB min (A-weighted)

Menu and Controls

- Power & Pair button protected inside battery compartment
- A20-Remote, mobile device application of iOS, iPad, and Android

Remote Control

- A20-Remote Android, iOS, and iPad app via Bluetooth 5.2 LE
- A20-Nexus via NexLink

Recording Media

- Internal 64 GB
- 10% over-provisioned for optimum performance

Recording File Format

- 32 Bit Float, 48 kHz, Monophonic
- Broadcast WAV (<4 GB), RF64 WAV (>4 GB)

Simultaneous Record and Transmit mode is not available on A20-Mini units sold or operated in the United States of America.

Timecode (LTC)

- Input via XL-TC-USBC-LEMO or XL-TC-USBC-BNC:
- 0.3 V - 3 V p-p (-17 dBu to +3 dBu), 20k ohm impedance
- Output via XL-TC-USBC-LEMO:
- 3 V p-p, 400 ohm impedance

Timecode Clock

- 0.2 ppm accuracy
- Holds accurate clock for four hours while powered down with batteries inserted, holds for one hour without batteries via internal supercap
- Auto Jams timecode from LTC source via USB-C connector, or from optional PowerStation-8M

Timecode Frame Rates

- 23.98, 24, 25, 29.97 DF, 29.97 ND, 30 DF, 30 ND
- Frame rates are auto-detected from incoming source

USB-C

- Mass Storage (USB-C): USB 2.0 high speed for file transfer
- Powers A20-Mini

Powering

- 3x AAA batteries (Energizer Ultimate AAA Lithium primary batteries recommended), or Sony NP-BX1 rechargeable Li-Ion
- Extended battery run time via the optional A20-BatteryDoubler
- Built-in Li-Ion charger via USB-C (7.5 W or more needed)
- Sony NP-BX1 is rechargeable via optional PowerStation-8M

Battery Runtime

- Up to 9 hours with A20-BatteryDoubler accessory; up to 5.5 hours with standard battery door
- Unit can be completely powered off remotely via app to extend battery runtime.

Environmental

- Operating: -10° C to 38° C
- Storage: -40° C to 85° C
- Water Resistant
- 0 to 90% relative humidity (non-condensing)

Dimensions (H x W x D)

- 75.8 mm (2.98 in) x 48 mm (1.88 in) x 19 mm (0.74 in); with standard battery door
- 75.8 mm (2.98 in) x 48 mm (1.88 in) x 26.5 mm (1.04 in); with A20-BatteryDoubler

Weight

- 51 g (without batteries)
- 1.8 oz (without batteries)

Antenna Guide

The A20-Mini ships with an antenna set with three antennas (1 straight 470-548 MHz, 1 straight 548-638 MHz, 1 straight uncut, set of antenna caps).

Sound Devices offers additional pre-cut and uncut antennas as available options.

Attach antennas with a length specific to the frequency in use. Using the wrong length of antenna reduces RF range.

Cutting Antennas to Length

Uncut antennas need to be cut to the length specific to the frequency for intended use.

1. Determine the frequency range intended for the uncut antenna using the Antenna Length chart.
2. Measure the antenna for the cut point. Measurements should begin from the bottom of the SMA connector.
3. Using a pair of cutters, cut the quarter-wave antenna at the specified cut point.
4. Position the antenna cap onto the cut-end of the antenna and push the cap firmly onto the antenna.

Antenna Length Chart

#	Frequency Range	Antennae Length in mm	Antennae Length in inches
1	470 - 548 MHz	140 mm	5.51"
2	548 - 663 MHz	120 mm	4.72"
3	638 - 738 MHz	104 mm	4.09"
4	738 - 865 MHz	89 mm	3.50"
5	902 - 1015 MHz	74 mm	2.92"
6	1045 - 1154 MHz	65 mm	2.55"
7	1240 - 1260 MHz	57 mm	2.24"
8	1350 - 1525 MHz	49 mm	1.93"



Servicing the A20-Mini

Do not attempt to service the A20-Mini. The case is water-sealed and needs to have new gaskets installed if taken apart. The internal parts are microscopic and not user serviceable. Please send to Sound Devices for any service needs.
<https://service.sounddevices.com/contact-support/>

Warranty

Sound Devices, LLC warrants the items listed above against defects in materials and workmanship for a period of ONE (1) year from date of original retail purchase. Users who register their product directly with Sound Devices Technical Support using the online form or by phone, will receive an additional ONE (1) year of warranty coverage, extending the complete warranty period to TWO (2) years from the date of original retail purchase. In order to extend the warranty coverage period, registration must be completed within the initial ONE (1) year warranty period. Products must be purchased through authorized Sound Devices resellers to qualify for Warranty coverage. Damage resulting from the opening of a Sound Devices product or attempted repairs by a non-authorized Sound Devices repair technician will void warranty coverage.

This is a non-transferable warranty that extends only to the original purchaser. Sound Devices, LLC will repair or replace the product at its discretion at no charge. Warranty claims due to severe service conditions will be addressed on an individual basis.

THE WARRANTY AND REMEDIES SET FORTH ABOVE ARE EXCLUSIVE. SOUND DEVICES, LLC DISCLAIMS ALL OTHER WARRANTIES, EXPRESS OR IMPLIED, INCLUDING WARRANTIES OF MERCHANTABILITY AND FITNESS FOR A PARTICULAR PURPOSE. SOUND DEVICES, LLC IS NOT RESPONSIBLE FOR SPECIAL, INCIDENTAL, OR CONSEQUENTIAL DAMAGES ARISING FROM ANY BREACH OF WARRANTY OR UNDER ANY OTHER LEGAL THEORY. Because some jurisdictions do not permit the exclusion or limitations set forth above, they may not apply in all cases.

For all service, including warranty repair, please contact Sound Devices for an RMA (return merchandise authorization) before sending your unit in for repair. Product returned without an RMA number may experience delays in repair. When sending a unit for repair, please do not include accessories, including SSD drives, CF cards, batteries, power supplies, carry cases, cables, or adapters unless instructed by Sound Devices. Sound Devices repairs and replacements may be completed using refurbished, returned or used parts that have been factory certified as functionally equivalent to new parts.

Sound Devices, LLC

Services Repair RMA #XXXXX

E7556 State Road 23 and 33
Reedsburg, WI 53959 USA
Telephone: +1-608-524-0625

Included Accessories

The A20-Mini includes the following accessories.

- **Antenna set** (1 straight 470-548 MHz, 1 straight 548-638 MHz, 1 straight uncut, 3 antenna caps)
- **A20-Mini Holster**

Legal Notices

Product specifications and features are subject to change without prior notification. Read and fully understand this manual before operation.

Copyright© 2022 Sound Devices, LLC. All rights reserved. This product is subject to the terms and conditions of a software license agreement provided with the product, and may be used in accordance with the license agreement. This document is protected under copyright law. An authorized licensee of this product may reproduce this publication for the licensee's own personal use. This document may not be reproduced or distributed, in whole or in part, for commercial purposes, such as selling copies or providing educational services or support. This document is supplied as a technical guide. Special care has been taken in preparing the information for publication; however, since product specifications are subject to change, this document might contain omissions and technical or typographical inaccuracies. Sound Devices, LLC does not accept responsibility for any losses due to the use of this guide.

LIMITATION ON SOUND DEVICES' LIABILITY. TO THE FULLEST EXTENT PERMITTED BY LAW, SOUND DEVICES SHALL HAVE NO LIABILITY TO THE END USER OR ANY OTHER PERSON FOR COSTS, EXPENSES, DIRECT DAMAGES, INCIDENTAL DAMAGES, PUNITIVE DAMAGES, SPECIAL DAMAGES, CONSEQUENTIAL DAMAGES OR OTHER DAMAGES OF ANY KIND OR NATURE WHATSOEVER ARISING OUT OF OR RELATING TO THE PRODUCTS, THESE TERMS AND CONDITIONS OR THE PARTIES' RELATIONSHIP, INCLUDING, WITHOUT LIMITATION, DAMAGES RESULTING FROM OR RELATED TO THE DELETION OR OTHER LOSS OF AUDIO RECORDINGS OR DATA, REDUCED OR DIMINISHED AUDIO QUALITY OR OTHER SIMILAR AUDIO DEFECTS ARISING FROM, RELATED TO OR OTHERWISE ATTRIBUTABLE TO THE PRODUCTS OR THE END USER'S USE OR OPERATION THEREOF, REGARDLESS OF WHETHER SUCH DAMAGES ARE CLAIMED UNDER CONTRACT, TORT OR ANY OTHER THEORY. "CONSEQUENTIAL DAMAGES" FOR WHICH SOUND DEVICES SHALL NOT BE LIABLE SHALL INCLUDE, WITHOUT LIMITATION, LOST PROFITS, PENALTIES, DELAY DAMAGES, LIQUIDATED DAMAGES AND OTHER DAMAGES AND LIABILITIES WHICH END USER SHALL BE OBLIGATED TO PAY OR WHICH END USER OR ANY OTHER PARTY MAY INCUR RELATED TO OR ARISING OUT OF ITS CONTRACTS WITH ITS CUSTOMERS OR OTHER THIRD PARTIES. NOTWITHSTANDING AND WITHOUT LIMITING THE FOREGOING, IN NO EVENT SHALL SOUND DEVICES BE LIABLE FOR ANY AMOUNT OF DAMAGES IN EXCESS OF AMOUNTS PAID BY THE END USER FOR THE PRODUCTS AS TO WHICH ANY LIABILITY HAS BEEN

DETERMINED TO EXIST. SOUND DEVICES AND END USER EXPRESSLY AGREE THAT THE PRICE FOR THE PRODUCTS WAS DETERMINED IN CONSIDERATION OF THE LIMITATION ON LIABILITY AND DAMAGES SET FORTH HEREIN AND SUCH LIMITATION HAS BEEN SPECIFICALLY BARGAINED FOR AND CONSTITUTES AN AGREED ALLOCATION OF RISK WHICH SHALL SURVIVE THE DETERMINATION OF ANY COURT OF COMPETENT JURISDICTION THAT ANY REMEDY HEREIN FAILS OF ITS ESSENTIAL PURPOSE.

The "wave" logo is a registered trademark of Sound Devices, LLC. Windows is a registered trademark of Microsoft Corporation in the U.S. and other countries. Bluetooth LE is a registered trademark of Bluetooth SIG, Inc. Android is a registered trademark of Google. iPad, iPhone, and iOS are registered trademark of Apple Inc. All other trademarks herein are the property of their respective owners.

FCC Conformity



This device complies with part 74 and part 15 of the FCC Rules. Operation is subject to the following two conditions:
(1) This device may not cause harmful interference, and
(2) this device must accept any interference received, including interference that may cause undesired operation.
Changes or modifications not expressly approved by the manufacturer could void the user's authority to operate the equipment.

Warning! Any modifications or changes made to this device, unless explicitly approved by Sound Devices may invalidate the authorization of this device. Operation of an unauthorized device is prohibited under Section 302 of the Communications act of 1934, as amended, and Subpart 1 of Part 2 of Chapter 47 of the Code of Federal Regulations.

FCC & ISED User Statement

This device complies with FCC and ISED RF exposure limits for general population / uncontrolled environments.

Cet appareil est conforme à la norme FCC et ISED les limites d'exposition pour la population générale / l'exposition incontrôlée

FCC Interference Statement

This equipment has been tested and found to comply with the limits for a Class B digital device, pursuant to Part 15 of the FCC Rules. These limits are designed to provide reasonable protection against harmful interference in a residential installation. This equipment generates uses and can radiate radio frequency energy and, if not installed and used in accordance with the instructions, may cause harmful interference to radio communications. However, there is no guarantee that interference will not occur in a particular installation. If this equipment does cause harmful interference to radio or television reception, which can be determined by turning the equipment off and on, the user is encouraged to try to correct the interference by one or more of the following measures:

- Reorient or relocate the receiving antenna
- Increase the separation between the equipment and receiver
- Connect the equipment into an outlet on a circuit different from that to which the receiver is connected
- Consult the dealer or an experienced radio/TV technician for help

Industry Canada Conformity

This device operates on a no-interference, no-protection basis. Should the user seek to obtain protection from other radio services operating in the same TV bands, a radio licence is required. For further details, consult Innovation, Science and Economic Development Canada's Client Procedures Circular CPC-2-1-28, Voluntary Licensing of Licence-Exempt Wireless Microphones in the TV Bands.

This radio transmitter 22225-9295W has been approved by Innovation, Science and Economic Development Canada to operate with the antenna types listed below, with the maximum permissible gain indicated. Antenna types not included in this list that have a gain greater than the maximum gain indicated for any type listed are strictly prohibited for use with this device.

The transmitter is supplied with the above unique antenna types; to replace a lost, damaged or faulty antenna, please contact Sound Devices, LLC.

Part #	Manufacturer	Description	Maximum Gain	Impedance
11224	Sound Devices, LLC	Antenna straight 470-548 MHz (140 mm / 5.51 ")	+2.15 dBi	50 ohms
11225	Sound Devices, LLC	Antenna straight 548-638 MHz (120 mm / 4.72 ")	+2.15 dBi	50 ohms

This Device complies with Industry Canada License-exempt RSS standard(s). Operation is subject to the following two conditions:

- 1) this device may not cause interference, and
- 2) this device must accept any interference, including interference that may cause undesired operation of the device.

Conformité à Industrie Canada

Cet appareil opère selon un régime de non-brouillage et de non-protection. Si l'utilisateur veut obtenir une protection par rapport aux autres services radio opérant sur les mêmes bandes TV, une licence radio est requise. Pour plus de détails, veuillez consulter le circulaire de procédures client CPC-2-1-28 Délivrance de licences sur une base volontaire pour les microphones sans fils exempts de licence exploités dans les bandes de télévision, publié par Innovation, Sciences et Développement économique Canada.

Ce transmetteur radio 22225-9295W a été approuvé par Innovation, Sciences et Développement économique Canada pour opérer avec les types d'antennes listés ci-dessous, avec gain maximum permissible indiqué. Les types d'antennes non inclus dans cette liste et dont le gain excède le gain maximum indiqué sur n'importe quel type listé ci-dessous sont strictement prohibés d'utilisation avec cet appareil.

Ce transmetteur est fourni avec les types d'antenne unique ci-dessus; pour remplacer une antenne perdue, endommagée ou défectueuse, veuillez contacter Sound Devices, LLC.

# Pièce	Manufacturier	Description	Gain Maximum	Impédance
11224	Sound Devices, LLC	Antenne droite 470-548 MHz (140 mm / 5.51 ")	+2.15 dBi	50 ohms

11225	Sound Devices, LLC	Antenne droite 548-638 MHz (120 mm / 4.72 ")	+2.15 dBi	50 ohms
-------	-----------------------	--	-----------	---------

Cet appareil est conforme aux normes CNR exemptes de licence d'Industrie Canada. Son fonctionnement est soumis aux deux conditions suivantes:

- 1) ce dispositif ne peut pas causer d'interférences, et
- 2) ce dispositif doit accepter toute interférence, y compris les interférences qui peuvent causer un mauvais fonctionnement de l'appareil.

WEEE Statement

If you wish to discard a Sound Devices product in Europe, contact Sound Devices (England) for further information.

**Battery Advisory**

Incorrect use of batteries poses a danger of explosion. Replace only with the same or equivalent type. Properly recycle batteries. Do not crush, disassemble, incinerate, dispose in a fire or expose batteries to high temperatures.

Declaration of Conformity



Manufacturer's Name: Sound Devices, LLC
Manufacturer's Address: E7556 State Road 23 and 33 Reedsburg, WI 53959 USA

We, Sound Devices LLC, declare under our sole responsibility that the product

Product Name:	A20-Mini
Model Number:	9295
Description:	Digital Wireless Microphone Transmitter

is in conformity with the essential requirements of the following relevant Union harmonisation legislation:

Radio Equipment Directive (RED)	2014/53/EU
Low Voltage Directive	2014/35/EU
RoHS Directive	2011/65/EU

The following harmonised standards and/or normative documents were applied:

Health & Safety (Article 3.1(a) of RED)	EN 62368-1:2014 EN 50566:2017
EMC (Article 3.1(b) of RED)	EN 301-489-1 v2.2.3:2019 EN 301-489-9 v2.1.1:2019 EN 301-489-17 v3.2.4:2020
RF Spectrum (Article 3.2 of RED)	EN 300 422-1 v2.1.2:2017 EN 300 328 v2.2.2:2019 EN 300 440 v2.1.1:2017

Signed for and on behalf of Sound Devices LLC:

July 20th, 2021

Date



Matt Anderson - Sound Devices, LLC President

SOUND  **DEVICES**

Post Office Box 576
E7556 State Rd. 23 and 33
Reedsburg, Wisconsin 53959 USA

support@sounddevices.com

+1608.524.0625 main
800.505.0625 toll free (U.S. only)

www.sounddevices.com