

BOLT 6



Table of Contents

Quick Start Guides

- Bolt 6 XT Quick Start Guide 4
- Bolt 6 LT Quick Start Guide 18
- Bolt 6 LT-HDMI Quick Start Guide 31
- Bolt 6 Monitor Module Quick Start Guide 42
- Bolt 6 LT TX (Japan) Quick Start Guide 52
- Bolt 6 XT TX (Japan) Quick Start Guide 65

Physical Properties

- Bolt 6 XT System 77
- Bolt 6 LT System 79
- Bolt 6 LT-HDMI 80
- Bolt 6 Monitor Module (TX/RX) 81

Getting Started

- Device Operation 81
- Power and Connect 82
- Power Cables 84

Configuration

- Wireless Configuration 85
- Wireless Configuration Recommendations 88
- Pairing and Unpairing 90
- Video Settings Configuration 93
- Tools 95
- Advanced Settings 99
- Info 101
- Bolt Manager 102

Bolt App

- Bolt App 105

Mounting

Device Placement	107
Antenna Orientation	109
Additional Information	
Regulatory Information	110
Bolt 6 U-NII-5 (6GHz) support by region	118
Frequencies by Region.....	120
Technical Specifications	
Bolt 6 XT System.....	120
Bolt 6 LT System.....	124
Bolt 6 LT-HDMI System	128
Bolt 6 Monitor Module	131
Bolt Panel Antenna v.4.....	134

Bolt 6 XT Quick Start Guide

The Bolt 6 XT Set is a real-time wireless video transmission system that supports 4K video with Teradek's patented Zero-Delay technology, now with less interference using the newly opened 6GHz wireless frequency. Bolt 6 XT can send and receive color-accurate, True-HDR videos in under 0.001 seconds using the set's included Bolt 6 XT video Transmitter and Receiver. Bolt 6 XT has been redesigned to seamlessly fit into your setup, with a smaller, lighter-weight build that runs cooler and 50% quieter than the Bolt 4K. An integrated 5-pin USB port allows for effortless and wireless camera-control setup when using SmallHD Smart Monitors, and an improved long range wireless video mode. Bolt 6 also offers new tools for high-end users to have better visibility over their connections and signals, adding confidence to the workflow no matter how challenging the environment.

Table of Contents

1. [WHAT'S INCLUDED](#)
2. [PHYSICAL PROPERTIES](#)
3. [POWER AND CONNECT](#)
4. [PAIRING](#)
5. [POWER CABLES](#)
6. [MOUNTING](#)
7. [TX/RX CONFIGURATION MENUS](#)
 - [Wireless Settings](#)
 - [Video Settings](#)
 - [Tools](#)
 - [Advanced/System Settings](#)
 - [Additional Information](#)
8. [BOLT APP](#)
9. [OTHER RESOURCES](#)

What's Included

- Bolt 6 XT Transmitter and Receiver
- Lightstand Adapter 3/8in
- Hot Shoe Adaptor
- (Bit 118) 2pin Conn. to PowerTap - 18in Cable
- Ultra Thin HDMI Male Type A (Full) - HDMI Male Type A (Full) 18in Cable
- SDI 12G BNC to BNC Cable Length: 18in / 46cm
- USB 2.0 Type A Male to USB Type C Male - 1m Cable
- PSU 2pin Conn. to 30W AC Adapter (Int) - 6ft Cable

Physical Properties



Power and Connect

1. Connect your power source to the transmitter and receiver using the included A/C adapter. If both devices are equipped with battery plate accessories, attach a compatible battery (**Gold** or **V mount**).
2. Connect the output from your video source to either the SDI or HDMI input (**D** or **G**) on the Bolt transmitter.
3. Connect either the SDI or HDMI output (**E** or **K**) from the Bolt receiver to the video input on your monitor.
4. Turn the units on by moving the power switches on both the transmitter and receiver (**J**) to the ON position.

Pairing/Unpairing

Bolt devices purchased as a set (TX and RX), are paired by default, requiring no additional configuration. Bolt devices purchased separately need to be paired using the device's front panel (OLED) menu, **Bolt Manager**, or the **Bolt App**. To pair your transmitter with multiple receivers, you will need to use either Bolt Manager or the Bolt App. **NOTE: Before starting either pairing process, ensure that both the transmitter and receiver have the same firmware version and have Bluetooth enabled.**

PAIRING/UNPAIRING VIA FRONT PANEL

To Pair:

1. Using the Menu Joystick, navigate to the **Pair** menu on both the transmitter and the receiver front panel.
2. Select **Pair** to begin the pairing process. The transmitter will begin scanning for a receiver within range and automatically pair to the receiver.
3. Once paired, the front panel will indicate whether or not Pairing is successful.

To Unpair:

1. Navigate to the **Unpair** menu on either the transmitter and the receiver.
2. Select the transmitter/receiver you want to unpair. If you have multiple devices paired, you can select **Unpair All**.

PAIRING TIPS

If you're having trouble getting units to pair, we recommend keeping the transmitter and receiver six feet apart when pairing. Keep all other RF devices nearby turned off or out of range to ensure the transmitter and receiver are only detecting each other. To eliminate any chance of interference, perform the Wired Pairing process via Bolt Manager.

PAIRING VIA BOLT APP

To Pair:

1. Open the Bolt App from your iOS or Android device, then tap the **Pairing** button.
2. Select the transmitter you wish to pair, then tap the **Next** button.
3. Select the receiver(s) you wish to pair with the transmitter, then tap the **Pair!** button. The Bolt App will indicate when the pairing process is complete.

To Unpair:

1. Open the Bolt App from your iOS or Android device, then tap the settings button (3 dots) on the top right corner of the screen.
2. Enter the **Pairing** menu, select the receiver(s) you wish to unpair, then tap the **Unpair** button.

WIRED PAIRING VIA BOLT MANAGER

To Pair:

1. Connect both the transmitter and receiver(s) to your computer (Windows/Mac) via USB.
2. Open Bolt Manager, select the **Pairing** tab, then tap the **Wired Pairing** button.
3. Select the devices you want to pair, then click the **Pair Devices** button. Bolt Manager will indicate whether or not Pairing is successful.

To Unpair:

1. Connect both the transmitter and receiver(s) to your computer (Windows/Mac) via USB.
2. Open Bolt Manager, select the **Pairing** tab, then tap the **Unpair All** button.

Power Cables

2-Pin Power Connector

Bolt devices use a locking 2-pin power connector similar to the 0B 302 series LEMO connector.

2-Pin Power Connector Pin Out	
Pin	Description
1*	GND
2	+DC

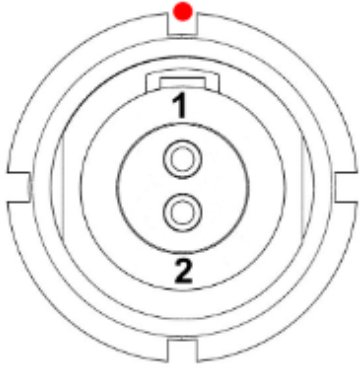

* Pin 1 is closest to the red dot on the connector.

Input Voltage: 6-28V DC

Max Power Consumption: 20W (TX) and 18W (RX)

Custom/3rd Party Cables

- Test the power cable polarity with **ONLY** the power cable connected to Bolt. Do not connect video cables.
- Check the power cable for shorts and proper grounding.

12G-SDI Input/Output Cables

Bolt 6 XT units require the use of 12G-SDI cables to reliably transport 12G video signals, and are included as a standard item. Ensure that your cables are rated for compatibility with your camera's output.

CAUTION:

Using a reverse polarity or improperly-constructed power cable can damage the product and is not covered under warranty. To prevent the inputs from being damaged, best practice is to

plug in the power cable first, THEN connect the video cable from the camera before powering on the TX unit.

Mounting

WITHOUT DUAL MOUNT

Bolt 6 XT devices have a 1/4"-20 threaded hole (additional 3/8"-16 threaded hole on the receiver) and two M3 threaded holes on the bottom for mounting the included light stand adapter or any other mounting accessory.

CAUTION: DO NOT OVERTIGHTEN SCREWS INSERTED INTO THE THREADED HOLES. Doing so can damage the device's chassis and internal components, voiding the warranty.

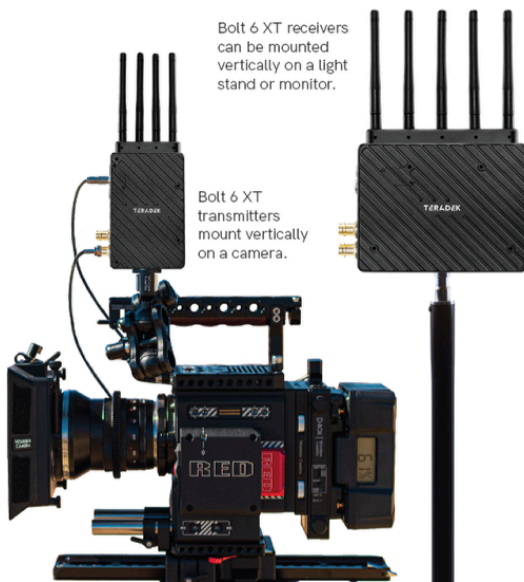

WITH DUAL MOUNT

Depending on the model, Bolt 6 XT devices are equipped with a dual mount battery plate that allows you to attach your device to either the back of a camera, monitor, or Bolt Panel Antenna.



TX/RX Configuration Menus

Wireless Settings

Switch TX (RX Only) - Bolt 6 receivers can pair with up to four transmitters at a time. Switch TX allows you to quickly switch from one paired transmitter's camera feed to another paired transmitter. This feature is especially useful in multi-camera situations when you need to switch to a different camera's view mid-shoot, without having to perform the pairing process every time. **NOTE: The transmitter(s) need to first be paired with the receiver.**

Band - Select either the **5GHz** or **6GHz** wireless frequency. The 5GHz frequency provides more channels but is utilized by more devices, resulting in frequent interferences and video dropouts. The 6GHz frequency is less crowded than the 5GHz frequency, resulting in faster connections and less interference. **NOTE: The 6GHz band is intended for indoor use only.**

Enable Broadcast Mode (Bolt 6 XT MAX units only)- Broadcast Mode allows you to transmit to multiple receivers simultaneously (non-DFS frequencies only), while also extending your Bolt 6's transmission range.

- **Broadcast Mode Disabled (Standard Multicast Mode)** - Transmitter and connected receiver(s) coordinate and maintain two-way communication with each other to optimize frequency usage and video transmission.
- **Broadcast Mode Enabled** - Data uplink channel is disabled, allowing the transmitter to connect to an unlimited number of receivers, as long as they have already been paired. To achieve even better range performance, attach the receiver to your Bolt Panel Antenna while in Broadcast Mode.
NOTE: Bolt 6 XT 750 and 1500 receivers will not link to a Bolt 6 XT MAX transmitter in Broadcast

Mode, even if they were previously paired. You must use a Bolt 6 XT MAX receiver. Otherwise, the receiver's OLED will display **Broadcast Not Supported**.

Enable Fixed Frequency - Fixed Frequency Mode allows your transmitter to designate a specific non-DFS channel within the selected wireless region for use, providing a stronger connection in difficult environments. There are two options for Fixed Frequency Mode:

1. Non-DFS and non-6GHz channels
2. Specific non-DFS 5GHz channels

NOTE: By default, Bolt 6 XT will select the lowest available frequency from the Frequencies list if one has not been selected beforehand.

Bandwidth - Choose between 20MHz and 40MHz bandwidth options

Frequencies - Select which frequency to use (determined by **Fixed Frequency Mode** selection).

Video Quality - The Video Quality menu lets you adjust the balance between your signal's maximum range and quality according to the number of antennas used to transmit fine information. Bolt 6 XT has several picture quality levels that vary based on the lowest quality link or the furthest receiver.

- **Auto Mode** - (*Default*) Transmitter automatically determines how many fine antennas are needed based on the range and signal quality.
- **Longer Distance Mode** - (*One fine antenna*) Maintains the maximum range in situations where other sources of interference might be present, but will slightly reduce your video signal's maximum quality.
- **Better Quality Mode** - (*Two fine antennas*) Maintains higher signal quality but reduces the maximum range.
- **Best Quality Mode** - (*Three fine antennas*) Ideal for complex, high-contrast scenes that require the highest possible quality.
- **Low Power Mode** - (*One fine antenna with shorter range*) Reduces the transmitter's total power consumption by about 1.5W and may reduce any unwanted interference in multi-system environments.

Video Settings

HDMI/SDI Output (RX only) - Select the video output format. You can choose to match the video source's resolution (**Same As Input**) or choose from the resolutions listed. If using the receiver with a recorder or monitor that is sensitive to video signal changes, select **Continuous Output** to ensure the signal stays constant even if the link is interrupted. Note that this adds a small delay to the video output.

3D LUT Settings (RX Only) - The 3D LUT settings menu contains specific looks that can be applied to your video output that either match or simulate how the video will appear after editing, along with options for how they are overlaid on your video output (**Full** or **Split-screen**).

- **3D LUT Presets** - Select a specific look from the list of 3D LUT presets.
- **3D LUT Mode** - Select whether the look is applied to the entire video output (**Full Screen**) or half (**Split Screen**).

Video OSD Settings (RX Only) - Choose when to display the OSD.

- **Never show** - Disable OSD.
- **Show when operating** - Hide OSD until it is activated by the joystick.
- **Show when no video** - Display the OSD when there is no video feed; hide the OSD when video appears (default).
- **Always show** - Always display OSD unless temporarily deactivated by the joystick.

Display Settings - Use the Display Settings to control the OLED display operation. By default, the OLED display will invert every 30 minutes.

Tools

SDI Eye Pattern (TX only) - The SDI Eye Pattern provides a graphical display of the SDI signal coming from the camera to the transmitter, and is useful in determining the amount of interference present. The size of the "eye" displayed on the front panel indicates the quality of the SDI signal. The bigger the size of the eye pattern is, the better the SDI signal.

Signal Quality Graph (RX Only) - The Signal Quality Graph indicates the quality and reliability of the signal being received according to the amount of interference that is present between the RX and TX. Signal Quality is represented in percentages:

- Figures below 30% indicate **poor** signal quality
- Figures between 30% and 45% indicate **fair** signal quality
- Figures above 45% indicate **good** signal quality

Spectrum Analyzer (RX Only) - The built-in Spectrum Analyzer provides a visual indication of channel noise and saturation across the entire available frequency range. Move the Menu joystick left and right to select a frequency. Frequencies are represented by bars; the higher the bar, the more congested that frequency is.

Test Pattern (RX Only) - This menu allows you to select a video resolution format to output a test pattern over HDMI or SDI. Select a specific output resolution from the resolutions list.

Advanced/System Settings

Lock Keypad - The Lock Keypad feature prevents the menu joystick from being used to avoid any accidental or unauthorized configurations. There are two ways to lock the keypad:

- Navigate to **Advanced Settings** via the front panel and select **Lock Keypad**.
- Press and hold the menu joystick upward for 5 seconds.

To unlock, press and hold the menu joystick upwards for five seconds or until the display reads "**KEYPAD UNLOCKED**."

HDMI (RX only) - Bolt 6 supports all HDMI output modes. You can select from one of the following options:

- Auto
- RGB 8bit
- RGB 10bit
- YCbCR 4:4:4 8bit
- YCbCR 4:4:4 10bit
- YCbCR 4:2:2 10bit
- YCbCR 4:2:0 8bit
- YCbCR 4:2:0 10bit

Audio (RX only) - Configure Bolt's Audio settings. If **Beep on REC** is activated, you will hear a short tone whenever the camera begins or stops recording. The **Mute Settings** allow you to completely mute audio or only mute audio while recording.

Bluetooth - Use the Bluetooth menu to enable or disable Bluetooth communication. **NOTE: Bluetooth is enabled by default.**

- **Enable Bluetooth** - Allows transmitter and receiver to be paired and communicate with the Bolt App.
- **Use Bluetooth PIN** - Enables the use of a PIN for authentication when using the Bolt App.
- **Change PIN** - Press the Menu joystick towards the right to change the Bluetooth PIN

Background Color (RX only)- The Background Color feature allows you to select a screen color to be displayed on the monitor when there is no video being received from the transmitter. This is a useful tool that indicates to the crew that a signal has been dropped and the TX and RX need to be synced again.

Reset All Settings - Reset all configurable options to their factory settings.

Additional Information

Device Info - Displays the model and serial number of the device

Firmware Versions - Displays the current firmware versions for all device components.

Regulatory - Displays all compliance certifications and certification markings related to radio frequencies used by the TX and RX to communicate. For complete regulatory information and declarations of conformity, please visit the [Regulatory Information](#) section.

Bolt App

Use the Bolt App to remotely manage and monitor every parameter of Bolt 6 including pairing, frequency selection, and 3D LUTs.

CONNECT VIA BLUETOOTH

1. Download the Bolt App.
2. Enable Bluetooth on your iOS or Android device.
3. Navigate to the Bluetooth menu on both the transmitter and receiver, then select **Enable**.
4. Open the Bolt App from your iOS or Android device, then tap the **Bolt Devices** button.
5. Select the device(s) you want to pair or monitor.

Transmitter Status Display



- **Settings** (Descriptions listed in [Transmitter Menu](#) section) - Tap the settings button on the top right corner of the screen to customize the transmitter’s various settings.
- **Status** - Displays the current status of:
 - Video Input
 - Network Status
 - Connected Receivers
 - Current Frequency
 - Quality
 - Temperature
 - Camera Recording
 - Region
 - Bandwidth
 - OSD name

Receiver Status Display

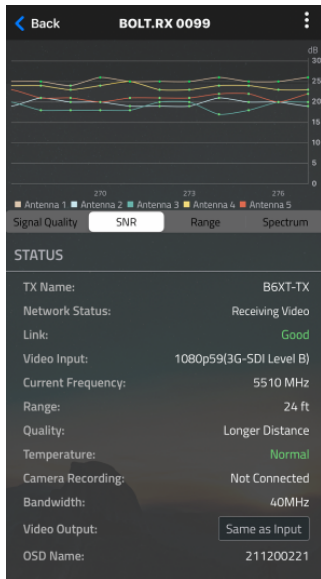

- **Settings** (Descriptions listed in [Receiver Menu](#) section) - Tap the settings button on the top-right corner of the display to customize the receiver’s various settings such as the output format, audio, display, and OSD.
- **Signal Quality** - Determine the quality and reliability of the signal being received.
- **SNR (Signal to Noise Ratio)** - Compare the signal power level to the noise power level from the antennas.
- **Range Analyzer** - Displays the transmission distance between the transmitter and receiver.

- **Status** - Displays the current status of:
 - TX Name
 - Network Status
 - Link
 - Video Input
 - Current Frequency
 - Range
 - Quality
 - Temperature
 - Camera Recording
 - Bandwidth
 - Region
 - Video Output
 - OSD name

Other Resources

- **USER MANUAL:** <https://guide.teradek.com/m/112641>
- **FIRMWARE UPGRADE:** <https://teradek.com/pages/downloads#bolt6>

Bolt 6 LT Quick Start Guide

The Bolt 6 LT Set is a real-time wireless video transmission system that supports 4K video with Teradek's patented Zero-Delay technology, now with less interference using the newly opened 6GHz wireless frequency. Bolt 6 LT can send and receive color-accurate, True-HDR videos in under 0.001 seconds using the set's included Bolt 6 LT video Transmitter and Receiver. Bolt 6 LT is cross-compatible with the entire Bolt 4K Series – including Bolt 4K, Bolt 4K LT, and the Bolt 4K Monitor Modules – giving you the option to expand your workflow requirements. Link up to 6 receivers to one transmitter, or unlimited receivers when used in Broadcast Mode (available on MAX models).

Table of Contents

1. [WHAT'S INCLUDED](#)
2. [PHYSICAL PROPERTIES](#)
3. [POWER AND CONNECT](#)
4. [PAIRING](#)
5. [POWER CABLES](#)
6. [MOUNTING](#)
7. [TX/RX CONFIGURATION MENUS](#)
 - [Wireless Settings](#)
 - [Video Settings](#)
 - [Tools](#)
 - [Advanced/System Settings](#)
 - [Additional Information](#)
8. [BOLT APP](#)
9. [OTHER RESOURCES](#)

What's Included

- Bolt 6 LT Transmitter and Receiver
- Hot Shoe Adaptor
- Lightstand Adapter 1/4-20in
- (Bit 118) 2pin Conn. to PowerTap - 18in Cable
- (Bit 718) 2pin Conn. to 2pin Conn. (Alexa) 18in Cable
- SDI - BNC to BNC Cable, 10in
- USB Male Type A (Full) - USB Male Type B (Micro) -3ft Cable
- Ultra Thin HDMI Male Type A (Full) - HDMI Male Type A (Full) 18in Cable
- PSU 2pin Conn. to 18W AC Adapter (Int) - 6ft Cable

Physical Properties



Power and Connect

1. Connect your power source to the transmitter and receiver using the included A/C adapter. If both devices are equipped with battery plate accessories, attach a compatible battery (**Gold** or **V mount**).
2. Connect the output from your video source to either the SDI or HDMI input (**C** or **E**) on the Bolt transmitter.
3. Connect either the SDI or HDMI output (**D** or **J**) from the Bolt receiver to the video input on your monitor.
4. Turn the units on by moving the power switches on both the transmitter and receiver (**J**) to the ON position.

Pairing/Unpairing

Bolt devices purchased as a set (TX and RX), are paired by default, requiring no additional configuration. Bolt devices purchased separately need to be paired using the device's front panel (OLED) menu, **Bolt Manager**, or the **Bolt App**. To pair your transmitter with multiple receivers, you will need to use either Bolt Manager or the Bolt App. **NOTE: Before starting either pairing process, ensure that both the transmitter and receiver have the same firmware version and have Bluetooth enabled.**

PAIRING/UNPAIRING VIA FRONT PANEL

Pair:

1. Using the Menu Joystick, navigate to the **Pair** menu on both the transmitter and the receiver front panel.
2. Select **Pair** to begin the pairing process. The transmitter will begin scanning for a receiver within range and automatically pair to the receiver.
3. Once paired, the front panel will indicate whether or not Pairing is successful.

To Unpair:

1. Navigate to the **Unpair** menu on either the transmitter and the receiver.
2. Select the transmitter/receiver you want to unpair. If you have multiple devices paired, you can select **Unpair All**.

PAIRING TIPS

If you're having trouble getting units to pair, we recommend keeping the transmitter and receiver six feet apart when pairing. Keep all other RF devices nearby turned off or out of range to ensure the transmitter and receiver are only detecting each other. To eliminate any chance of interference, perform the Wired Pairing process via Bolt Manager.

PAIRING VIA BOLT APP

Pair:

1. Open the Bolt App from your iOS or Android device, then tap the **Pairing** button.
2. Select the transmitter you wish to pair, then tap the **Next** button.
3. Select the receiver(s) you wish to pair with the transmitter, then tap the **Pair!** button. The Bolt App will indicate when the pairing process is complete.

To Unpair:

1. Open the Bolt App from your iOS or Android device, then tap the TX settings button (3 dots) on the top right corner of the screen.
2. Enter the **Pairing** menu, select the receiver(s) you wish to unpair, then tap the **Unpair** button.

WIRED PAIRING VIA BOLT MANAGER

To Pair:

1. Connect both the transmitter and receiver(s) to your computer (Windows/Mac) via USB.
2. Open Bolt Manager, select the **Pairing** tab, then tap the **Wired Pairing** button.
3. Select the devices you want to pair, then click the **Pair Devices** button. Bolt Manager will indicate whether or not Pairing is successful.

To Unpair:

1. Connect the transmitter to your computer (Windows/Mac) via USB.
2. Open Bolt Manager, select the **Pairing** tab, then tap the **Unpair All** button.

Power Cables

2-Pin Power Connector

Bolt devices use a locking 2-pin power connector similar to the 0B 302 series LEMO connector.

2-Pin Power Connector Pin Out		
Pin	Description	
1*	GND	
2	+DC	

* Pin 1 is closest to the red dot on the connector.

Input Voltage: 6-28V DC

Max Power Consumption: 20W (TX) and 18W (RX)

Custom/3rd Party Cables

- Test the power cable polarity with **ONLY** the power cable connected to Bolt. Do not connect video cables.
- Check the power cable for shorts and proper grounding.

CAUTION:

Using a reverse polarity or improperly-constructed power cable can damage the product and is not covered under warranty. To prevent the inputs from being damaged, best practice is to plug in the power cable first, THEN connect the video cable from the camera before powering on the TX unit.

Mounting

WITHOUT DUAL MOUNT

Bolt 6 LT devices have a 1/4"-20 threaded hole and two M3 threaded holes on the bottom for mounting the included light stand adapter or any other mounting accessory.

⚠ CAUTION: DO NOT OVERTIGHTEN SCREWS INSERTED INTO THE THREADED HOLES. Doing so can damage the device's chassis and internal components, voiding the warranty.

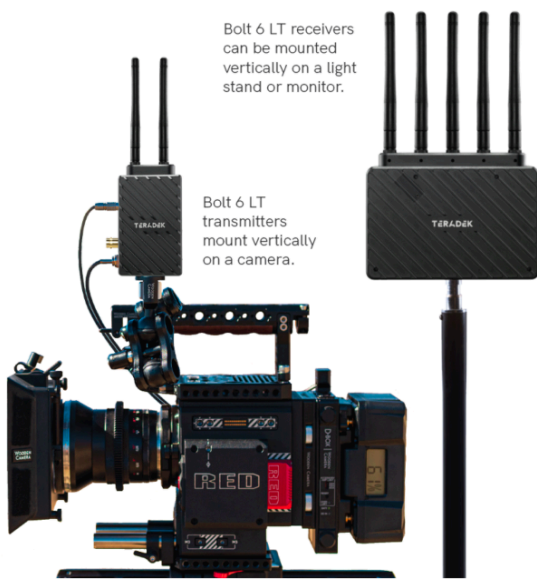

TX/RX Configuration Menus

Wireless Configuration

Switch TX (RX Only) - Bolt 6 receivers can pair with up to four transmitters at a time. Switch TX allows you to quickly switch from one paired transmitter's camera feed to another paired transmitter. This feature is especially useful in multi-camera situations when you need to switch to a different camera's view mid-shoot, without having to perform the pairing process every time. **NOTE: The transmitter(s) need to first be paired with the receiver.**

Band - Select either the **5GHz** or **6GHz** wireless frequency. The 5GHz frequency provides more channels but is utilized by more devices, resulting in frequent interferences and video dropouts. The 6GHz

frequency is less crowded than the 5GHz frequency, resulting in faster connections and less interference. **NOTE: The 6GHz band is intended for indoor use only**

Enable Broadcast Mode (Bolt 6 LT MAX transmitters only) - Broadcast Mode allows you to transmit to multiple receivers simultaneously (non-DFS frequencies only), while also extending your Bolt 6's transmission range.

- **Broadcast Mode Disabled** (Standard Multicast Mode) - Transmitter and connected receiver(s) coordinate and maintain two-way communication with each other to optimize frequency usage and video transmission.
- **Broadcast Mode Enabled** - Data uplink channel is disabled, allowing the transmitter to connect to an unlimited number of receivers, as long as they have already been paired. To achieve even better range performance, attach the receiver to your Bolt Panel Antenna while in Broadcast Mode.
NOTE: Bolt 6 LT 750 and 1500 receivers will not link to a Bolt 6 LT MAX transmitter in Broadcast Mode, even if they were previously paired. You must use a Bolt 6 LT MAX receiver. Otherwise, the transmitter's OLED will display **Broadcast Not Supported**.

Enable Fixed Frequency - Fixed Frequency Mode allows your transmitter to designate a specific non-DFS channel within the selected wireless region for use, providing a stronger connection in difficult environments. There are two options for Fixed Frequency Mode:

1. Non-DFS and non-6GHz channels
2. Specific non-DFS 5GHz channels

NOTE: By default, Bolt 6 LT will select the lowest available frequency from the Frequencies list if one has not been selected beforehand.

Bandwidth - Choose between 20MHz and 40MHz bandwidth options

Frequencies - Select which frequency to use (determined by **Fixed Frequency Mode** selection).

Video Quality - The Video Quality menu lets you adjust the balance between your signal's maximum range and quality according to the number of antennas used to transmit fine information. Bolt 6 LT has three picture quality levels that vary based on the lowest quality link or the furthest receiver.

- **Auto Mode** - (*Default*) Transmitter automatically determines how many fine antennas are needed based on the range and signal quality.
- **Longer Distance Mode** - (*One fine antenna*) Maintains the maximum range in situations where other sources of interference might be present, but will slightly reduce your video signal's maximum quality.
- **Better Quality Mode** - (*Two fine antennas*) Maintains higher signal quality but reduces the maximum range.

Video Settings

3D LUT Settings (RX Only) - The 3D LUT settings menu contains specific looks that can be applied to your video output that either match or simulate how the video will appear after editing, along with options for how they are overlaid on your video output (**Full** or **Split-screen**).

- **3D LUT Presets** - Select a specific look from the list of 3D LUT presets.
- **3D LUT Mode** - Select whether the look is applied to the entire video output (**Full Screen**) or half (**Split Screen**).

Video OSD Settings (RX Only) - Choose when to display the OSD.

- **Never show**
- **Show when operating**
- **Show when no video**
- **Always show**

Display Settings - Use the Display Settings to control the OLED display operation. By default, the OLED display will invert every 30 minutes.

Tools

Signal Quality Graph (RX Only) - The Signal Quality Graph indicates the quality and reliability of the signal being received according to the amount of interference that is present between the RX and TX. Signal Quality is represented in percentages:

- Figures below 30% indicate **poor** signal quality
- Figures between 30% and 45% indicate **fair** signal quality
- Figures above 45% indicate **good** signal quality

Spectrum Analyzer (RX Only) - The built-in Spectrum Analyzer provides a visual indication of channel noise and saturation across the entire available frequency range. Move the Menu joystick left and right to select a frequency. Frequencies are represented by bars; the higher the bar, the more congested that frequency is.

Test Pattern (RX Only) - This menu allows you to select a video resolution format to output a test pattern over HDMI or SDI. Select a specific output resolution from the resolutions list.

Advanced/System Settings

Lock Keypad - The Lock Keypad feature prevents the menu joystick from being used to avoid any accidental or unauthorized configurations. There are two ways to lock the keypad:

- Navigate to **Advanced Settings** via the front panel and select **Lock Keypad**.
- Press and hold the menu joystick upward for 5 seconds.

To unlock, press and hold the menu joystick upwards for five seconds or until the display reads "**KEYPAD UNLOCKED**."

HDMI (RX only) - Bolt 6 supports all HDMI output modes. You can select from one of the following options:

- Auto
- RGB 8bit
- RGB 10bit
- YCbCR 4:4:4 8bit
- YCbCR 4:4:4 10bit
- YCbCR 4:2:2 10bit
- YCbCR 4:2:0 8bit
- YCbCR 4:2:0 10bit

Audio (RX only) - Configure Bolt's Audio settings. If **Beep on REC** is activated, you will hear a short tone whenever the camera begins or stops recording. The **Mute Settings** allow you to completely mute audio or only mute audio while recording.

Bluetooth - Use the Bluetooth menu to enable or disable Bluetooth communication. **NOTE: Bluetooth is enabled by default.**

- **Enable Bluetooth** - Allows transmitter and receiver to be paired and communicate with the Bolt App.
- **Use Bluetooth PIN** - Enables the use of a PIN for authentication when using the Bolt App.
- **Change PIN** - Press the Menu joystick towards the right to change the Bluetooth PIN

Background Color (RX only)- The Background Color feature allows you to select a screen color to be displayed on the monitor when there is no video being received from the transmitter. This is a useful tool that indicates to the crew that a signal has been dropped and the TX and RX need to be synced again.

Reset All Settings - Reset all configurable options to their factory settings.

Additional Information

Device Info - Displays the model and serial number of the device

Firmware Versions - Displays the current firmware versions for all device components.

Regulatory - Displays all compliance certifications and certification markings related to radio frequencies used by the TX and RX to communicate. For complete regulatory information and declarations of conformity, please visit the [Regulatory Information](#) section.

Bolt App

Use the Bolt App to remotely manage and monitor every parameter of Bolt 6 including pairing, frequency selection, and 3D LUTs.

CONNECT VIA BLUETOOTH

1. Download the Bolt App.
2. Enable Bluetooth on your iOS or Android device.
3. Navigate to the Bluetooth menu on both the transmitter and receiver, then select **Enable**.
4. Open the Bolt App from your iOS or Android device, then tap the **Bolt Devices** button.
5. Select the device(s) you want to pair or monitor.

Transmitter Status Display



- **Settings** (Descriptions listed in [Transmitter Menu](#) section) - Tap the settings button on the top right corner of the screen to customize the transmitter's various settings.
- **Status** - Displays the current status of:
 - Video Input
 - Network Status
 - Connected Receivers
 - Current Frequency
 - Quality
 - Temperature
 - Camera Recording
 - Region
 - Bandwidth
 - OSD name

Receiver Status Display

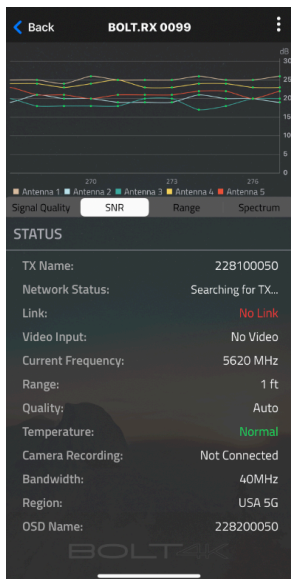

- **Settings** (Descriptions listed in [Receiver Menu](#) section) - Tap the settings button on the top-right corner of the display to customize the receiver's various settings such as the output format, audio, display, and OSD.
- **Signal Quality** - Determine the quality and reliability of the signal being received.
- **SNR (Signal to Noise Ratio)** - Compare the signal power level to the noise power level from the antennas.
- **Range Analyzer** - Displays the transmission distance between the transmitter and receiver.

- **Status** - Displays the current status of:
 - TX Name
 - Network Status
 - Link
 - Video Input
 - Current Frequency
 - Range
 - Quality
 - Temperature
 - Camera Recording
 - Bandwidth
 - Region
 - OSD name

Other Resources

- **USER MANUAL:** <https://guide.teradek.com/m/112641>
- **FIRMWARE UPGRADE:** <https://teradek.com/pages/downloads#bolt6>

Bolt 6 LT-HDMI Quick Start Guide

The Bolt 6 LT HDMI Set is a real-time wireless video transmission system that supports 4K video with Teradek's patented Zero-Delay technology, now with less interference using the newly opened 6GHz wireless frequency. Bolt 6 LT can send and receive color-accurate, True-HDR videos in under 0.001 seconds. When used in high-traffic areas, 6GHz wireless frequency gives Bolt 6 LT-HDMI users more options for frequency adjustments with 12 new channels. Bolt 6 can also pass metadata, timecode, and start/stop flags from most camera manufacturers.

Table of Contents

1. [WHAT'S INCLUDED](#)
2. [PHYSICAL PROPERTIES](#)
3. [POWER AND CONNECT](#)
4. [PAIRING](#)
5. [POWER CABLES](#)
6. [MOUNTING](#)
7. [TX/RX CONFIGURATION MENUS](#)
 - [Wireless Settings](#)
 - [Bluetooth Settings](#)
 - [Display Settings](#)
 - [Reset All Settings](#)
 - [Device Info](#)
 - [Firmware Versions](#)
8. [BOLT APP](#)
9. [OTHER RESOURCES](#)

What's Included

- Bolt 6 LT-HDMI Transmitter and Receiver
- 1x Hot Shoe Adaptor
- 1x (Bit 118) 2pin Conn. to PowerTap - 18in Cable
- 2x Ultra Thin HDMI Male Type A (Full) - HDMI Male Type A (Full) 18in Cable
- 1x USB 2.0 Type A Male to USB Type C Male - 1m Cable

Physical Properties

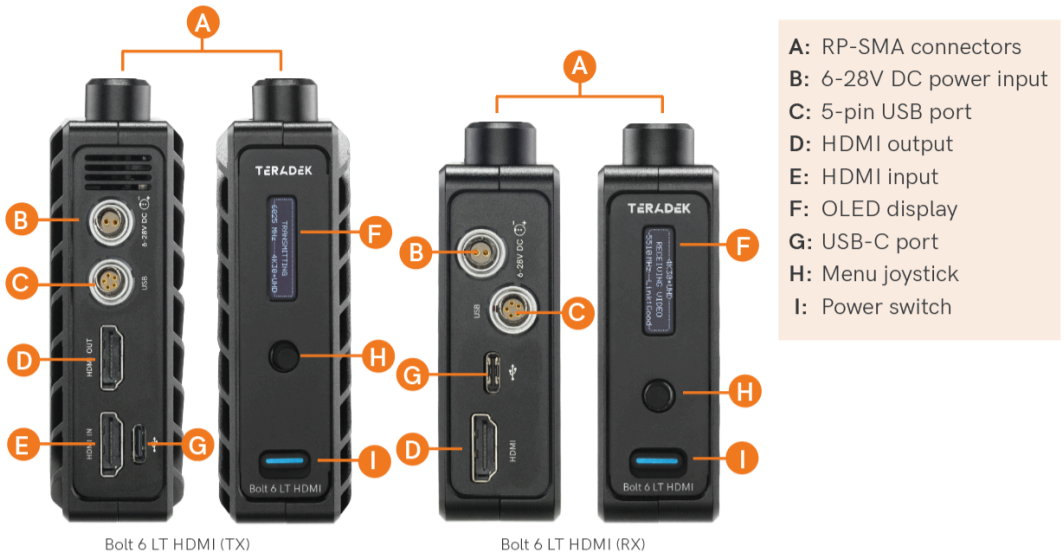

Power and Connect

1. Connect your power source to the transmitter and receiver using the included A/C adapter. If the receiver is equipped with a battery plate, attach a compatible battery (**Gold** or **V mount**).
2. Connect the output from your video source to the HDMI input (**E**) on the Bolt transmitter.
3. Connect the HDMI output (**D**) from the Bolt receiver to the video input on your monitor.
4. Move the power switches on both the transmitter and receiver (**I**) to the ON position.

Pairing/Unpairing

Bolt devices purchased as a set (TX and RX), are paired by default, requiring no additional configuration. Bolt devices purchased separately need to be paired using the device's front panel (OLED) menu, **Bolt Manager**, or the **Bolt App**. To pair your transmitter with multiple receivers, you will need to use either Bolt Manager or the Bolt App. **NOTE: Before starting either pairing process, ensure that both the transmitter and receiver have the same firmware version and have Bluetooth enabled.**

PAIRING/UNPAIRING VIA FRONT PANEL

Pair:

1. Using the Menu Joystick, navigate to the **Pair** menu on both the transmitter and the receiver front panel.

2. Select **Pair** to begin the pairing process. The transmitter will begin scanning for a receiver within range and automatically pair to the receiver.
3. Once paired, the front panel will indicate whether or not Pairing is successful.

To Unpair:

1. Navigate to the **Unpair** menu on either the transmitter and the receiver.
2. Select the transmitter/receiver you want to unpair. If you have multiple devices paired, you can select **Unpair All**.

PAIRING TIPS

If you're having trouble getting units to pair, we recommend keeping the transmitter and receiver six feet apart when pairing. Keep all other RF devices nearby turned off or out of range to ensure the transmitter and receiver are only detecting each other. To eliminate any chance of interference, perform the [Wired Pairing](#) process via Bolt Manager.

PAIRING VIA BOLT APP

Pair:

1. Open the Bolt App from your iOS or Android device, then tap the **Pairing** button.
2. Select the transmitter you wish to pair, then tap the **Next** button.
3. Select the receiver(s) you wish to pair with the transmitter, then tap the **Pair!** button. The Bolt App will indicate when the pairing process is complete.

To Unpair:

1. Open the Bolt App from your iOS or Android device, then tap the TX settings button (3 dots) on the top right corner of the screen.
2. Enter the **Pairing** menu, select the receiver(s) you wish to unpair, then tap the **Unpair** button.

WIRED PAIRING VIA BOLT MANAGER

To Pair:

1. Connect both the transmitter and receiver(s) to your computer (Windows/Mac) via USB.
2. Open Bolt Manager, select the **Pairing** tab, then tap the **Wired Pairing** button.
3. Select the devices you want to pair, then click the **Pair Devices** button. Bolt Manager will indicate whether or not Pairing is successful.

To Unpair:

1. Connect the transmitter to your computer (Windows/Mac) via USB.
2. Open Bolt Manager, select the **Pairing** tab, then tap the **Unpair All** button.

Power Cables

2-Pin Power Connector

Bolt devices use a locking 2-pin power connector similar to the 0B 302 series LEMO connector.

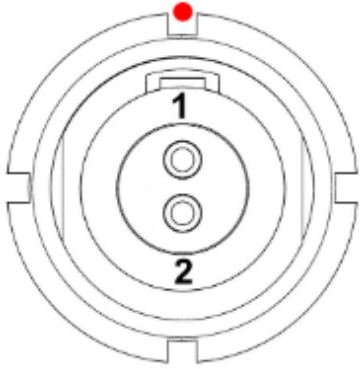
2-Pin Power Connector Pin Out		
Pin	Description	
1*	GND	
2	+DC	

* Pin 1 is closest to the red dot on the connector.

Input Voltage: 6-28V DC

Max Power Consumption: 20W (TX) and 18W (RX)

Custom/3rd Party Cables

- Test the power cable polarity with **ONLY** the power cable connected to Bolt. Do not connect video cables.
- Check the power cable for shorts and proper grounding.

CAUTION:

Using a reverse polarity or improperly-constructed power cable can damage the product and is not covered under warranty. To prevent the inputs from being damaged, best practice is to plug in the power cable first, THEN connect the video cable from the camera before powering on the TX unit.

Mounting

Bolt 6 LT devices have a 1/4"-20 threaded hole and two M3 threaded holes on the bottom for mounting the included light stand adapter or any other mounting accessory.

CAUTION: DO NOT OVERTIGHTEN SCREWS INSERTED INTO THE THREADED HOLES. Doing so can damage the device's chassis and internal components, voiding the warranty.



TX/RX Configuration Menus

Wireless Settings

Band - Select either the **5GHz** or **6GHz** wireless frequency. The 5GHz frequency allows for higher total output power and backward compatibility with Bolt 4K devices but is more likely to experience interference from other wireless devices. The 6GHz (U-NII-5) band is virtually vacant compared to the 5GHz band, and although the allowed output power is lower, it should offer better connection stability with fewer interruptions. **NOTE: The 6GHz band is intended for indoor use only.**

Enable Fixed Frequency - Fixed Frequency Mode allows your transmitter to designate a specific non-DFS channel within the selected wireless region for use, providing a stronger connection in difficult environments. There are two options for Fixed Frequency Mode:

1. Non-DFS and non-6GHz channels

2. Specific non-DFS 5GHz channels

NOTE: By default, Bolt 6 LT-HDMI will select the lowest available frequency from the Frequencies list if one has not been selected beforehand.

Select Bandwidth - Choose between 20MHz and 40MHz bandwidth options

Select Frequency - Select which frequency to use (determined by **Fixed Frequency Mode** selection).

Bluetooth Settings

Use the Bluetooth menu to enable or disable Bluetooth communication. **NOTE: Bluetooth is enabled by default.**

- **Enable Bluetooth** - Allows transmitter and receiver to be paired and communicate with the Bolt App.
- **Use Bluetooth PIN** - Enables the use of a PIN for authentication when using the Bolt App.
- **Change PIN** - Press the Menu joystick towards the right to change the Bluetooth PIN

Display Settings

Use the Display Settings to control the OLED display operation. By default, the OLED display will invert every 30 minutes. You can set the display to invert every 30 minutes (lengthens the display life), or it can dim or turn off after 10 seconds or 10 minutes.

Reset All Settings

Reset all configurable options to their factory settings.

Device Info

Displays the model and serial number of the device, and all compliance certifications and certification markings related to radio frequencies used by the TX and RX to communicate.

Firmware Versions

Displays the current firmware versions for all device components.

Bolt App

Use the Bolt App to remotely manage and monitor every parameter of Bolt 6 including pairing, frequency selection, and 3D LUTs.

CONNECT VIA BLUETOOTH

1. Download the Bolt App.
2. Enable Bluetooth on your iOS or Android device.
3. Navigate to the Bluetooth menu on both the transmitter and receiver, then select **Enable**.
4. Open the Bolt App from your iOS or Android device, then tap the **Bolt Devices** button.
5. Select the device(s) you want to pair or monitor.

Transmitter Status Display

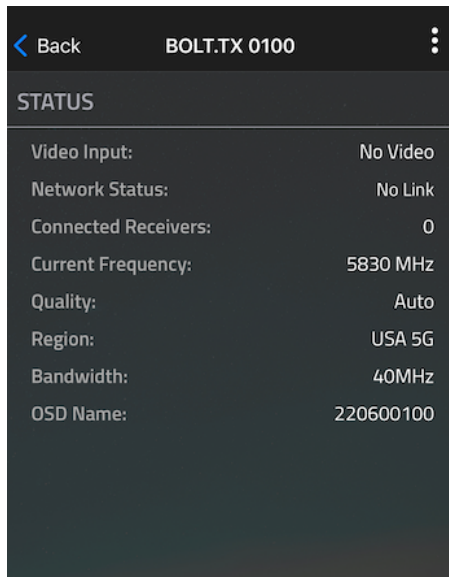

- **Settings** (Descriptions listed in [Transmitter Menu](#) section) - Tap the settings button on the top right corner of the screen to customize the transmitter's various settings.
- **Status** - Displays the current status of:
 - Video Input
 - Network Status
 - Connected Receivers
 - Current Frequency
 - Quality
 - Region
 - Bandwidth

- OSD name

Receiver Status Display

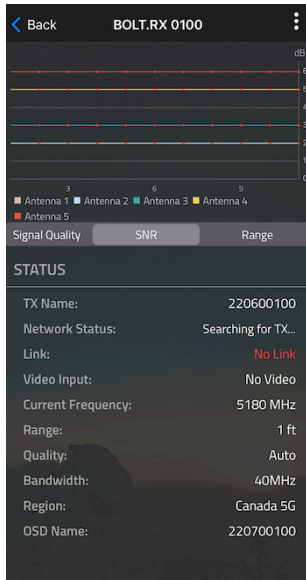

- **Settings** (Descriptions listed in [Receiver Menu](#) section) - Tap the settings button on the top-right corner of the display to customize the receiver's various settings such as the output format, audio, display, and OSD.
- **Signal Quality** - Determine the quality and reliability of the signal being received.
- **SNR (Signal to Noise Ratio)** - Compare the signal power level to the noise power level from the attached antennas.
- **Range Analyzer** - Displays the transmission distance between the transmitter and receiver.
- **Status** - Displays the current status of:
 - TX Name
 - Network Status
 - Link
 - Video Input
 - Current Frequency
 - Range
 - Quality
 - Bandwidth
 - Region
 - OSD name

Other Resources

- USER MANUAL: <https://guide.teradek.com/m/112641>
- FIRMWARE UPGRADE: <https://teradek.com/pages/downloads#bolt6>

Bolt 6 Monitor Module Quick Start Guide

The Bolt 6 Monitor Module (TX or RX) is a real-time wireless video transmitter that supports 4K video with Teradek's patented Zero-Delay technology, now with less interference using the newly opened 6GHz wireless frequency. This Monitor Module integrates directly with the SmallHD Smart 7 Monitor Series. Send color-accurate, 4K HDR videos in under 0.001 milliseconds. Key features of the Bolt 6 Monitor Module include range options designed for a variety of production needs, fast reconnection times, intuitive and easy setup with the Bolt Manager App for iOS or Android, and consistent, stable connectivity.

Table of Contents

1. [PHYSICAL PROPERTIES](#)
2. [POWER AND CONNECT](#)
3. [PAIRING](#)
 - [Pairing via Smart 7 Monitor](#)
 - [Pairing via Bolt App](#)
4. [BOLT APP](#)
 - [Transmitter Status Display](#)
 - [Receiver Status Display](#)
5. [MODULE CONFIGURATION MENUS](#)
 - [TX Module Configuration](#)
 - [RX Module Configuration](#)
6. [BOLT APP](#)
7. [OTHER RESOURCES](#)

Physical Properties

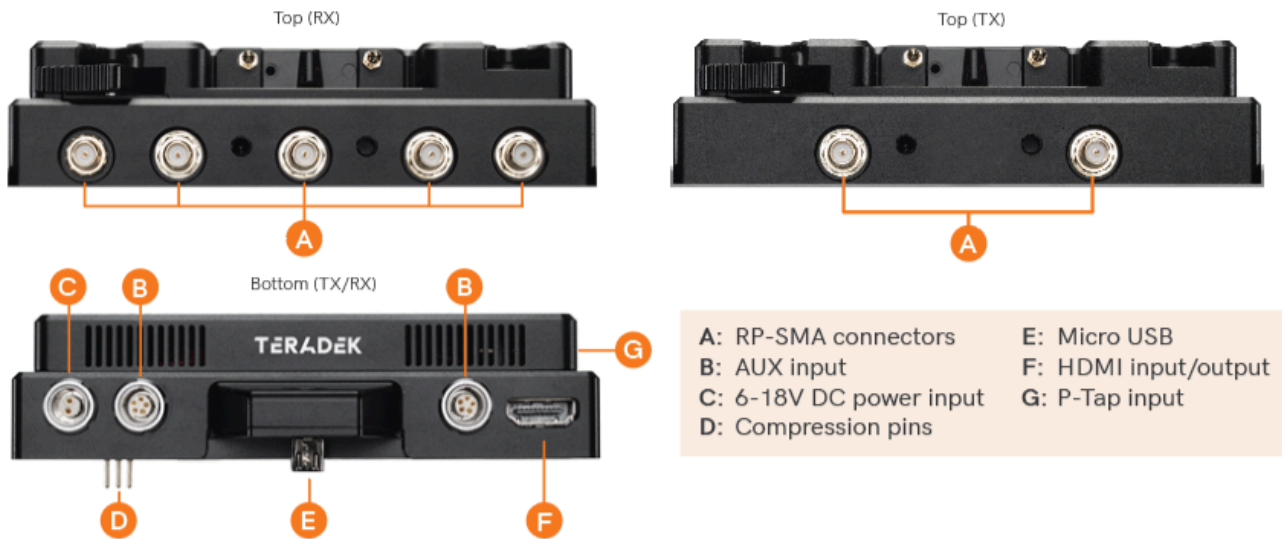

Power and Connect

1. Remove the battery plate from the back.
2. **TX Module** - Detach the cover plate from the back of the Bolt 4K Monitor Module to expose the JST connector.
 - RX Module** - Remove the battery plate from the back of the Bolt 4K Monitor Module to expose the

two top mounting holes.

NOTE: There is no need to disconnect the JST connector.

3. Place the monitor module firmly against the back of the Smart 7 monitor. Ensure the two top mounting holes, connector pins, and micro USB align with their corresponding terminals.
4. Insert two M3 socket-head screws through the two top mounting holes on the monitor module and into the back of the monitor (**see image below**). **DO NOT OVER-TIGHTEN.**
5. **TX Module - (OPTIONAL)** Attach an L-series battery plate to the monitor module, then tighten the four Phillips screws.
RX Module - Reattach the battery plate to the monitor module, then tighten the four Phillips screws.
6. Insert, then tighten the 1/4"-20 hex screw to secure the monitor module assembly against the back of the monitor (**see image below**). **DO NOT OVER-TIGHTEN.**
7. Attach a compatible battery to the battery plate (**optional for TX Module**), or connect power to the module's 6-18V DC input using the included A/C adapter.
NOTE: Ensure the A/C adapter is connected to the module and NOT the monitor.
8. Turn the system on by pressing and holding down the monitor's power button.

Pairing

Before use, Bolt 6 Monitor Modules need to be paired with a Bolt 6 transmitter or receiver using SmallHD Smart 7's user interface or the Bolt App. **NOTE: Before starting any pairing process, ensure that both the transmitter, receiver, and monitor have the latest firmware version and have Bluetooth enabled.**

Pairing via Smart 7 Monitor

TO PAIR:

1. Swipe right on the monitor's touchscreen, then tap on the **Settings** option once it appears.
2. Scroll back up and tap to select the **TERADEK BOLT 4K** option, then tap **Pair new receiver**.
3. Enable Pairing on the Bolt 6 receiver(s) or by selecting **Pair** on the front panel menu. The Monitor Module will begin scanning for receivers to automatically pair with. **Note: You can pair the transmitter with up to six receivers at one time.**
4. Once the devices are paired successfully, tap **Accept** to dismiss the menu. If pairing fails, try again.

TO UNPAIR:

1. Swipe right on the monitor's touchscreen, then tap on the **Settings** option once it appears.
2. Scroll down the left column and select the **TERADEK BOLT 4K** option, then tap **Unpair ALL receivers**.

PAIRING TIPS

If you're having trouble getting units to pair, we recommend keeping the transmitter and receiver six feet apart when pairing. Keep all other RF devices nearby turned off or out of range to ensure the transmitter and receiver are only detecting each other. To eliminate any chance of interference, perform the Wired Pairing process via Bolt Manager.

Pairing via Bolt App

1. Swipe right on the monitor's touchscreen until **Settings** is displayed, then scroll down the left column and navigate to **Accessories>App Connection**.
2. Select **Enable Device Discovery**.
3. Open the Bolt App from your iOS or Android device, then tap **Pairing**.
4. Select the transmitter/receiver you wish to pair, then tap **Next**.
5. Select **SmallHD Monitor**, then tap the **Pair!** button. The Bolt App will indicate when the pairing process is completed.

Bolt App

Use the Bolt App to remotely manage and monitor every parameter of the Bolt 6 Monitor Module including pairing, frequency selection, and 3D LUTs.

CONNECT VIA BLUETOOTH

1. Download the Bolt App.
2. Enable Bluetooth on your iOS or Android device.
3. Open the Bolt App, then tap the **Status/Configuration** button.
4. Select the device you want to monitor.

Transmitter Status Display

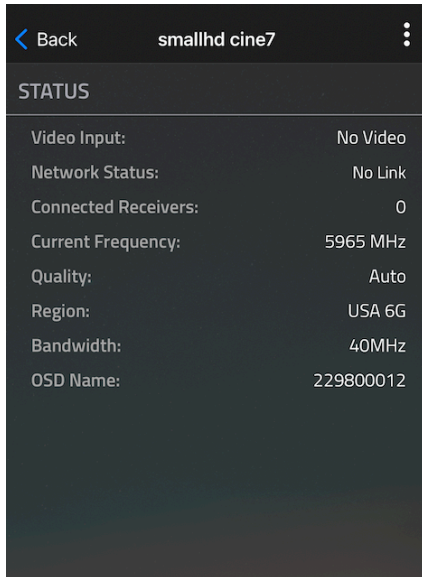

- **Settings** (Descriptions listed in the [Transmitter Menu](#) section) - Tap the settings button on the top right corner of the screen to customize the transmitter's various settings.
- **Status** - Displays the current status of:
 - Video Input
 - Network Status
 - Connected Receivers
 - Current Frequency
 - Quality
 - Region
 - Bandwidth
 - OSD name

Receiver Status Display

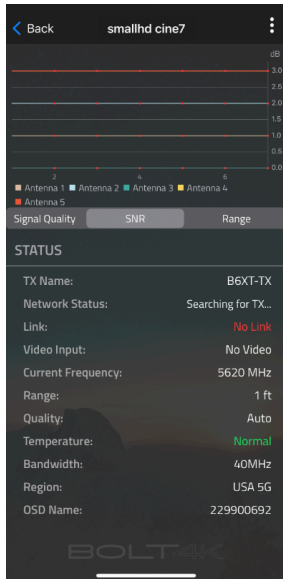

- **Settings** (Descriptions listed in [Receiver Menu](#) section) - Tap the settings button on the top-right corner of the display to customize the receiver's various settings such as the output format, audio, display, and OSD.
- **Signal Quality** - Determine the quality and reliability of the signal being received.
- **SNR (Signal to Noise Ratio)** - Compare the signal power level to the noise power level from the attached antennas.
- **Range Analyzer** - Displays the transmission distance between the transmitter and receiver.
- **Status** - Displays the current status of:
 - TX Name
 - Network Status
 - Link
 - Video Input
 - Current Frequency
 - Range
 - Quality
 - Temperature
 - Bandwidth
 - Region
 - OSD name

Module Configuration Menus

Bolt 6 Monitor Modules can be configured using the Smart 7 Monitor's built-in interface. Once connected, tap the **TERADEK BOLT 4K** tab.

TX Module Configuration

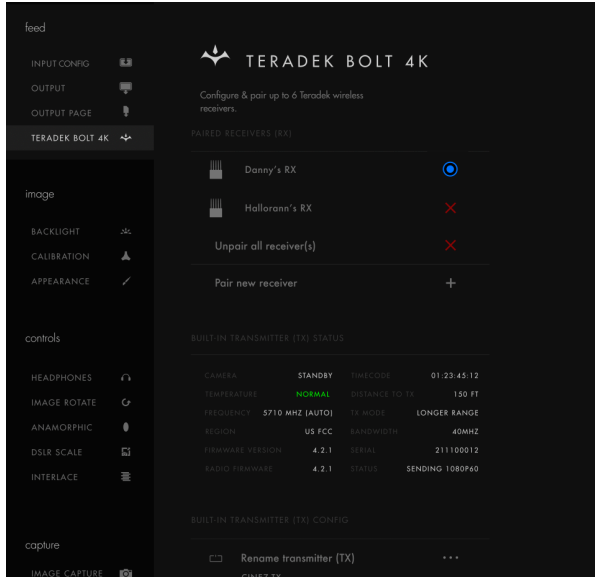

Paired Receivers - This screen displays all paired receivers (if any), and allows you to pair or unpair additional receivers with the TX module.

Built-In Transmitter (TX) Status - This screen displays the following information:

- Camera
- Controller Version
- TX Mode
- Temperature
- Radio Version
- Bandwidth
- Frequency
- Timecode
- Serial
- Region
- Distance to RX
- Status

Built-In Transmitter (TX) Configuration

- Rename transmitter (TX) - Rename the transmitter so that it's easier to identify among other Bolt systems that are present.
- Video quality - Select a video quality setting to modify or balance the range and reliability of the signal.
- Frequency mode - Select either **AUTO** or **FIXED** mode.
- Available frequencies - Specify which frequency to use whenever Fixed Frequency Mode is enabled.
- Bandwidth - Select either 20MHz or 40MHz.
- Fan Mode - Turn the internal fan OFF or ON or enable the fan to remain **OFF DURING RECORDING**.
- Band - Select either 5GHz or 6GHz.

RX Module Configuration

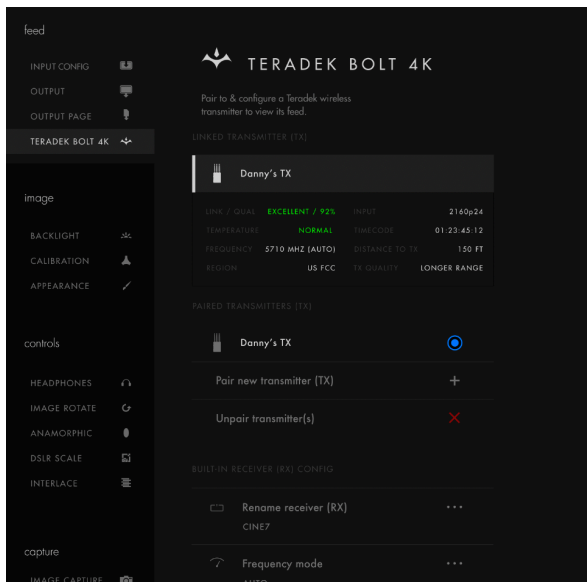

Linked Transmitter (TX) - This screen displays the name of the paired transmitter along with:

- Link/Quality Status
- Input Resolution
- Current Temperature
- Timecode
- Frequency
- Distance to TX
- Region
- TX Quality

Paired Transmitters (TX) - This screen displays all paired transmitters (if any), and allows you to pair or unpair transmitters with the monitor module.

Built-In Receiver (RX) Configuration

- Rename receiver (RX) - Rename the receiver so that it's easier to identify among other Bolt systems that are present.
- Frequency mode - Select either **AUTO** or **FIXED** mode.
- Selected Frequency - Specify which frequency to use whenever Fixed Frequency Mode is enabled.
- Bandwidth - Select either 20MHz or 40MHz.
- Band - Select either 5GHz or 6GHz.
- Fan Mode - Turn the internal fan OFF or ON or enable the fan to remain **OFF DURING RECORDING**.

Other Resources

- USER MANUAL: <https://guide.teradek.com/m/112641>
- FIRMWARE UPGRADE: <https://teradek.com/pages/downloads#bolt6>

Bolt 6 LT TX (Japan) Quick Start Guide

The **Bolt 6 LT TX (Japan) and RX** set was built to meet Japan's MICA 6GHz requirements for certification. It is a real-time wireless video transmission system that supports 4K video with Teradek's patented Zero-Delay technology, now with less interference using the newly opened 6GHz wireless frequency. Bolt 6 LT can send and receive color-accurate, True-HDR videos in under 0.001 seconds using the set's included Bolt 6 LT video Transmitter and Receiver. Bolt 6 LT is cross-compatible with the entire Bolt 4K Series – including Bolt 4K, Bolt 4K LT, and the Bolt 4K Monitor Modules – giving you the option to expand your workflow requirements. Link up to 6 receivers to one transmitter.

Table of Contents

1. [WHAT'S INCLUDED](#)
2. [PHYSICAL PROPERTIES](#)
3. [POWER AND CONNECT](#)
4. [PAIRING](#)
5. [POWER CABLES](#)
6. [TX/RX CONFIGURATION MENUS](#)
 - [Wireless Settings](#)
 - [Video Settings](#)
 - [Tools](#)
 - [Advanced/System Settings](#)
 - [Additional Information](#)
7. [BOLT APP](#)
8. [OTHER RESOURCES](#)

What's Included

- Bolt 6 LT Transmitter w/Internal Antenna and Receiver w/External Antenna
- Hot Shoe Adaptor
- Lightstand Adapter 1/4-20in
- (Bit 118) 2pin Conn. to PowerTap - 18in Cable
- (Bit 718) 2pin Conn. to 2pin Conn. (Alexa) 18in Cable
- SDI - BNC to BNC Cable, 10in
- USB Male Type A (Full) - USB Male Type B (Micro) -3ft Cable
- Ultra Thin HDMI Male Type A (Full) - HDMI Male Type A (Full) 18in Cable
- PSU 2pin Conn. to 18W AC Adapter (Int) - 6ft Cable

Physical Properties

BOLT 6 LT



Bolt 6 LT - Transmitter

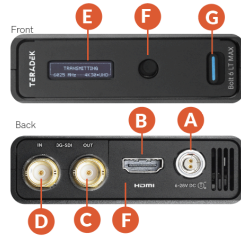

Bolt 6 LT - Receiver



- A: 6-28V DC power input
- B: HDMI input
- C: 12G-SDI output
- D: 12G-SDI input
- E: OLED display
- F: Menu joystick
- G: Power switch
- H: HDMI output

Power and Connect

1. Connect your power source to the transmitter and receiver using the included A/C adapter. If both devices are equipped with battery plate accessories, attach a compatible battery (**Gold** or **V mount**).
2. Connect the output from your video source to either the SDI or HDMI input (**C** or **E**) on the Bolt transmitter.
3. Connect either the SDI or HDMI output (**D** or **J**) from the Bolt receiver to the video input on your monitor.
4. Turn the units on by moving the power switches on both the transmitter and receiver (**J**) to the ON position.

Pairing/Unpairing

Bolt devices purchased as a set (TX and RX), are paired by default, requiring no additional configuration. Bolt devices purchased separately need to be paired using the device's front panel (OLED) menu, **Bolt Manager**, or the **Bolt App**. To pair your transmitter with multiple receivers, you will need to use either Bolt Manager or the Bolt App. **NOTE: Before starting either pairing process, ensure that both the transmitter and receiver have the same firmware version and have Bluetooth enabled.**

PAIRING/UNPAIRING VIA FRONT PANEL

Pair:

1. Using the Menu Joystick, navigate to the **Pair** menu on both the transmitter and the receiver front panel.
2. Select **Pair** to begin the pairing process. The transmitter will begin scanning for a receiver within range and automatically pair to the receiver.
3. Once paired, the front panel will indicate whether or not Pairing is successful.

To Unpair:

1. Navigate to the **Unpair** menu on either the transmitter and the receiver.
2. Select the transmitter/receiver you want to unpair. If you have multiple devices paired, you can select **Unpair All**.

PAIRING TIPS

If you're having trouble getting units to pair, we recommend keeping the transmitter and receiver six feet apart when pairing. Keep all other RF devices nearby turned off or out of range to ensure the transmitter and receiver are only detecting each other. To eliminate any chance of interference, perform the Wired Pairing process via Bolt Manager.

PAIRING VIA BOLT APP

Pair:

1. Open the Bolt App from your iOS or Android device, then tap the **Pairing** button.
2. Select the transmitter you wish to pair, then tap the **Next** button.
3. Select the receiver(s) you wish to pair with the transmitter, then tap the **Pair!** button. The Bolt App will indicate when the pairing process is complete.

To Unpair:

1. Open the Bolt App from your iOS or Android device, then tap the TX settings button (3 dots) on the top right corner of the screen.
2. Enter the **Pairing** menu, select the receiver(s) you wish to unpair, then tap the **Unpair** button.

WIRED PAIRING VIA BOLT MANAGER

To Pair:

1. Connect both the transmitter and receiver(s) to your computer (Windows/Mac) via USB.
2. Open Bolt Manager, select the **Pairing** tab, then tap the **Wired Pairing** button.
3. Select the devices you want to pair, then click the **Pair Devices** button. Bolt Manager will indicate whether or not Pairing is successful.

To Unpair:

1. Connect the transmitter to your computer (Windows/Mac) via USB.
2. Open Bolt Manager, select the **Pairing** tab, then tap the **Unpair All** button.

Power Cables

2-Pin Power Connector

Bolt devices use a locking 2-pin power connector similar to the 0B 302 series LEMO connector.

2-Pin Power Connector Pin Out		
Pin	Description	
1*	GND	
2	+DC	

* Pin 1 is closest to the red dot on the connector.

Input Voltage: 6-28V DC

Max Power Consumption: 20W (TX) and 18W (RX)

Custom/3rd Party Cables

- Test the power cable polarity with **ONLY** the power cable connected to Bolt. Do not connect video cables.
- Check the power cable for shorts and proper grounding.

CAUTION:

Using a reverse polarity or improperly-constructed power cable can damage the product and is not covered under warranty. To prevent the inputs from being damaged, best practice is to plug in the power cable first, THEN connect the video cable from the camera before powering on the TX unit.

TX/RX Configuration Menus

Wireless Configuration

Switch TX (RX Only) - Bolt 6 receivers can pair with up to four transmitters at a time. Switch TX allows you to quickly switch from one paired transmitter's camera feed to another paired transmitter. This feature is especially useful in multi-camera situations when you need to switch to a different camera's view mid-shoot, without having to perform the pairing process every time. **NOTE: The transmitter(s) need to first be paired with the receiver.**

Band - Select either the **5GHz** or **6GHz** wireless frequency. The 5GHz frequency provides more channels but is utilized by more devices, resulting in frequent interferences and video dropouts. The 6GHz frequency is less crowded than the 5GHz frequency, resulting in faster connections and less interference. **NOTE: The 6GHz band is intended for indoor use only**

Enable Broadcast Mode (Bolt 6 LT MAX transmitters only) - Broadcast Mode allows you to transmit to multiple receivers simultaneously (non-DFS frequencies only), while also extending your Bolt 6's transmission range.

- **Broadcast Mode Disabled** (Standard Multicast Mode) - Transmitter and connected receiver(s) coordinate and maintain two-way communication with each other to optimize frequency usage and video transmission.
- **Broadcast Mode Enabled** - Data uplink channel is disabled, allowing the transmitter to connect to an unlimited number of receivers, as long as they have already been paired. To achieve even better range performance, attach the receiver to your Bolt Panel Antenna while in Broadcast Mode. **NOTE: Bolt 6 LT 750 and 1500 receivers will not link to a Bolt 6 LT MAX transmitter in Broadcast Mode, even if they were previously paired. You must use a Bolt 6 LT MAX receiver. Otherwise, the transmitter's OLED will display **Broadcast Not Supported.****

Enable Fixed Frequency - Fixed Frequency Mode allows your transmitter to designate a specific non-DFS channel within the selected wireless region for use, providing a stronger connection in difficult environments. There are two options for Fixed Frequency Mode:

1. Non-DFS and non-6GHz channels
2. Specific non-DFS 5GHz channels

NOTE: By default, Bolt 6 LT will select the lowest available frequency from the Frequencies list if one has not been selected beforehand.

Bandwidth - Choose between 20MHz and 40MHz bandwidth options

Frequencies - Select which frequency to use (determined by **Fixed Frequency Mode** selection).

Video Quality - The Video Quality menu lets you adjust the balance between your signal's maximum range and quality according to the number of antennas used to transmit fine information. Bolt 6 LT has three picture quality levels that vary based on the lowest quality link or the furthest receiver.

- **Auto Mode** - (*Default*) Transmitter automatically determines how many fine antennas are needed based on the range and signal quality.
- **Longer Distance Mode** - (*One fine antenna*) Maintains the maximum range in situations where other sources of interference might be present, but will slightly reduce your video signal's maximum quality.
- **Better Quality Mode** - (*Two fine antennas*) Maintains higher signal quality but reduces the maximum range.

Video Settings

3D LUT Settings (RX Only) - The 3D LUT settings menu contains specific looks that can be applied to your video output that either match or simulate how the video will appear after editing, along with options for how they are overlaid on your video output (**Full** or **Split-screen**).

- **3D LUT Presets** - Select a specific look from the list of 3D LUT presets.
- **3D LUT Mode** - Select whether the look is applied to the entire video output (**Full Screen**) or half (**Split Screen**).

Video OSD Settings (RX Only) - Choose when to display the OSD.

- **Never show**
- **Show when operating**
- **Show when no video**
- **Always show**

Display Settings - Use the Display Settings to control the OLED display operation. By default, the OLED display will invert every 30 minutes.

Tools

Signal Quality Graph (RX Only) - The Signal Quality Graph indicates the quality and reliability of the signal being received according to the amount of interference that is present between the RX and TX. Signal Quality is represented in percentages:

- Figures below 30% indicate **poor** signal quality
- Figures between 30% and 45% indicate **fair** signal quality
- Figures above 45% indicate **good** signal quality

Spectrum Analyzer (RX Only) - The built-in Spectrum Analyzer provides a visual indication of channel noise and saturation across the entire available frequency range. Move the Menu joystick left and right to select a frequency. Frequencies are represented by bars; the higher the bar, the more congested that frequency is.

Test Pattern (RX Only) - This menu allows you to select a video resolution format to output a test pattern over HDMI or SDI. Select a specific output resolution from the resolutions list.

Advanced/System Settings

Lock Keypad - The Lock Keypad feature prevents the menu joystick from being used to avoid any accidental or unauthorized configurations. There are two ways to lock the keypad:

- Navigate to **Advanced Settings** via the front panel and select **Lock Keypad**.
- Press and hold the menu joystick upward for 5 seconds.

To unlock, press and hold the menu joystick upwards for five seconds or until the display reads "**KEYPAD UNLOCKED.**"

HDMI (RX only) - Bolt 6 supports all HDMI output modes. You can select from one of the following options:

- Auto
- RGB 8bit
- RGB 10bit
- YCbCR 4:4:4 8bit
- YCbCR 4:4:4 10bit
- YCbCR 4:2:2 10bit
- YCbCR 4:2:0 8bit
- YCbCR 4:2:0 10bit

Audio (RX only) - Configure Bolt's Audio settings. If **Beep on REC** is activated, you will hear a short tone whenever the camera begins or stops recording. The **Mute Settings** allow you to completely mute audio or only mute audio while recording.

Bluetooth - Use the Bluetooth menu to enable or disable Bluetooth communication. **NOTE: Bluetooth is enabled by default.**

- **Enable Bluetooth** - Allows transmitter and receiver to be paired and communicate with the Bolt App.
- **Use Bluetooth PIN** - Enables the use of a PIN for authentication when using the Bolt App.
- **Change PIN** - Press the Menu joystick towards the right to change the Bluetooth PIN

Background Color (RX only)- The Background Color feature allows you to select a screen color to be displayed on the monitor when there is no video being received from the transmitter. This is a useful

tool that indicates to the crew that a signal has been dropped and the TX and RX need to be synced again.

Reset All Settings - Reset all configurable options to their factory settings.

Additional Information

Device Info - Displays the model and serial number of the device

Firmware Versions - Displays the current firmware versions for all device components.

Regulatory - Displays all compliance certifications and certification markings related to radio frequencies used by the TX and RX to communicate. For complete regulatory information and declarations of conformity, please visit the [Regulatory Information](#) section.

Bolt App

Use the Bolt App to remotely manage and monitor every parameter of Bolt 6 including pairing, frequency selection, and 3D LUTs.

CONNECT VIA BLUETOOTH

1. Download the Bolt App.
2. Enable Bluetooth on your iOS or Android device.
3. Navigate to the Bluetooth menu on both the transmitter and receiver, then select **Enable**.
4. Open the Bolt App from your iOS or Android device, then tap the **Bolt Devices** button.
5. Select the device(s) you want to pair or monitor.

Transmitter Status Display



- **Settings** (Descriptions listed in [Transmitter Menu](#) section) - Tap the settings button on the top right corner of the screen to customize the transmitter's various settings.
- **Status** - Displays the current status of:
 - Video Input
 - Network Status
 - Connected Receivers
 - Current Frequency
 - Quality
 - Temperature
 - Camera Recording
 - Region
 - Bandwidth
 - OSD name

Receiver Status Display

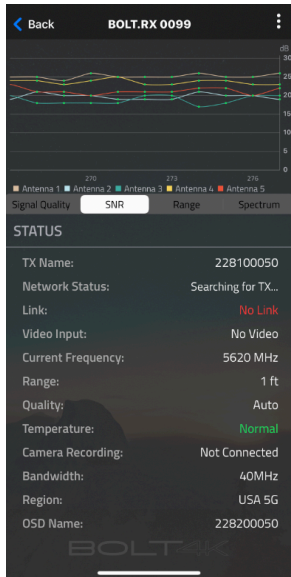

- **Settings** (Descriptions listed in [Receiver Menu](#) section) - Tap the settings button on the top-right corner of the display to customize the receiver's various settings such as the output format, audio, display, and OSD.
- **Signal Quality** - Determine the quality and reliability of the signal being received.
- **SNR (Signal to Noise Ratio)** - Compare the signal power level to the noise power level from the antennas.
- **Range Analyzer** - Displays the transmission distance between the transmitter and receiver.
- **Status** - Displays the current status of:
 - TX Name
 - Network Status
 - Link
 - Video Input
 - Current Frequency
 - Range
 - Quality
 - Temperature
 - Camera Recording
 - Bandwidth
 - Region
 - OSD name

Other Resources

- USER MANUAL: <https://guide.teradek.com/m/112641>
- FIRMWARE UPGRADE: <https://teradek.com/pages/downloads#bolt6>

Bolt 6 XT TX (Japan) Quick Start Guide

The **Bolt 6 XT TX (Japan) and RX** set was built to meet Japan's MICA 6GHz requirements for certification. It is a real-time wireless video transmission system that supports 4K video with Teradek's patented Zero-Delay technology, now with less interference using the newly opened 6GHz wireless frequency. Bolt 6 XT can send and receive color-accurate, True-HDR videos in under 0.001 seconds using the set's included Bolt 6 XT video Transmitter and Receiver. Bolt 6 XT has been redesigned to seamlessly fit into your setup, with a smaller, lighter-weight build that runs cooler and 50% quieter than the Bolt 4K. An integrated 5-pin USB port allows for an effortless and wireless camera-control setup when using SmallHD Smart Monitors, and an improved long-range wireless video mode. Bolt 6 also offers new tools for high-end users to have better visibility over their connections and signals, adding confidence to the workflow no matter how challenging the environment.

Table of Contents

1. [WHAT'S INCLUDED](#)
2. [PHYSICAL PROPERTIES](#)
3. [POWER AND CONNECT](#)
4. [PAIRING](#)
5. [POWER CABLES](#)
6. [TX/RX CONFIGURATION MENUS](#)
 - [Wireless Settings](#)
 - [Video Settings](#)
 - [Tools](#)
 - [Advanced/System Settings](#)
 - [Additional Information](#)
7. [BOLT APP](#)
8. [OTHER RESOURCES](#)

What's Included

- Bolt 6 XT Transmitter w/Internal Antenna and Receiver w/External Antenna
- Lightstand Adapter 3/8in
- Hot Shoe Adaptor
- (Bit 118) 2pin Conn. to PowerTap - 18in Cable
- Ultra Thin HDMI Male Type A (Full) - HDMI Male Type A (Full) 18in Cable
- SDI 12G BNC to BNC Cable Length: 18in / 46cm
- USB 2.0 Type A Male to USB Type C Male - 1m Cable
- PSU 2pin Conn. to 30W AC Adapter (Int) - 6ft Cable

Physical Properties

BOLT 6 XT



Bolt 6 XT - Transmitter

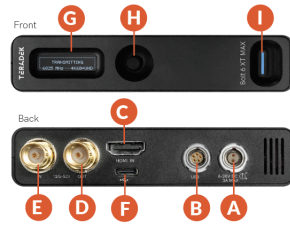

Bolt 6 XT - Receiver

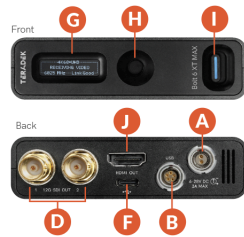

- A: 6-28V DC power input
- B: 5-Pin USB port
- C: HDMI input
- D: 12G-SDI output
- E: 12G-SDI input
- F: USB-C port
- G: OLED display
- H: Menu joystick
- I: Power switch
- J: HDMI output

Power and Connect

1. Connect your power source to the transmitter and receiver using the included A/C adapter. If both devices are equipped with battery plate accessories, attach a compatible battery (**Gold** or **V mount**).
2. Connect the output from your video source to either the SDI or HDMI input (**D** or **G**) on the Bolt transmitter.
3. Connect either the SDI or HDMI output (**E** or **K**) from the Bolt receiver to the video input on your monitor.
4. Turn the units on by moving the power switches on both the transmitter and receiver (**J**) to the ON position.

Pairing/Unpairing

Bolt devices purchased as a set (TX and RX), are paired by default, requiring no additional configuration. Bolt devices purchased separately need to be paired using the device's front panel (OLED) menu, **Bolt Manager**, or the **Bolt App**. To pair your transmitter with multiple receivers, you will need to use either Bolt Manager or the Bolt App. **NOTE: Before starting either pairing process, ensure that both the transmitter and receiver have the same firmware version and have Bluetooth enabled.**

PAIRING/UNPAIRING VIA FRONT PANEL

To Pair:

1. Using the Menu Joystick, navigate to the **Pair** menu on both the transmitter and the receiver front panel.
2. Select **Pair** to begin the pairing process. The transmitter will begin scanning for a receiver within range and automatically pair to the receiver.
3. Once paired, the front panel will indicate whether or not Pairing is successful.

To Unpair:

1. Navigate to the **Unpair** menu on either the transmitter and the receiver.
2. Select the transmitter/receiver you want to unpair. If you have multiple devices paired, you can select **Unpair All**.

PAIRING TIPS

If you're having trouble getting units to pair, we recommend keeping the transmitter and receiver six feet apart when pairing. Keep all other RF devices nearby turned off or out of range to ensure the transmitter and receiver are only detecting each other. To eliminate any chance of interference, perform the Wired Pairing process via Bolt Manager.

PAIRING VIA BOLT APP

To Pair:

1. Open the Bolt App from your iOS or Android device, then tap the **Pairing** button.
2. Select the transmitter you wish to pair, then tap the **Next** button.
3. Select the receiver(s) you wish to pair with the transmitter, then tap the **Pair!** button. The Bolt App will indicate when the pairing process is complete.

To Unpair:

1. Open the Bolt App from your iOS or Android device, then tap the settings button (3 dots) on the top right corner of the screen.
2. Enter the **Pairing** menu, select the receiver(s) you wish to unpair, then tap the **Unpair** button.

WIRED PAIRING VIA BOLT MANAGER

To Pair:

1. Connect both the transmitter and receiver(s) to your computer (Windows/Mac) via USB.
2. Open Bolt Manager, select the **Pairing** tab, then tap the **Wired Pairing** button.
3. Select the devices you want to pair, then click the **Pair Devices** button. Bolt Manager will indicate whether or not Pairing is successful.

To Unpair:

1. Connect both the transmitter and receiver(s) to your computer (Windows/Mac) via USB.
2. Open Bolt Manager, select the **Pairing** tab, then tap the **Unpair All** button.

Power Cables

2-Pin Power Connector

Bolt devices use a locking 2-pin power connector similar to the 0B 302 series LEMO connector.

2-Pin Power Connector Pin Out	
Pin	Description
1*	GND
2	+DC

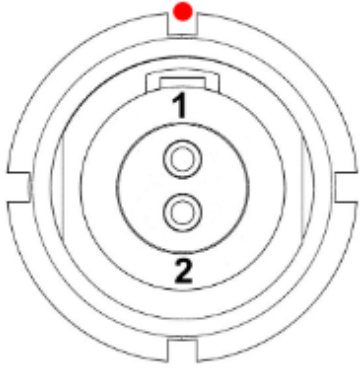

* Pin 1 is closest to the red dot on the connector.

Input Voltage: 6-28V DC

Max Power Consumption: 20W (TX) and 18W (RX)

Custom/3rd Party Cables

- Test the power cable polarity with **ONLY** the power cable connected to Bolt. Do not connect video cables.
- Check the power cable for shorts and proper grounding.

12G-SDI Input/Output Cables

Bolt 6 XT units require the use of 12G-SDI cables to reliably transport 12G video signals, and are included as a standard item. Ensure that your cables are rated for compatibility with your camera's output.

CAUTION:

Using a reverse polarity or improperly-constructed power cable can damage the product and is not covered under warranty. To prevent the inputs from being damaged, best practice is to

plug in the power cable first, THEN connect the video cable from the camera before powering on the TX unit.

TX/RX Configuration Menus

Wireless Settings

Switch TX (RX Only) - Bolt 6 receivers can pair with up to four transmitters at a time. Switch TX allows you to quickly switch from one paired transmitter's camera feed to another paired transmitter. This feature is especially useful in multi-camera situations when you need to switch to a different camera's view mid-shoot, without having to perform the pairing process every time. **NOTE: The transmitter(s) need to first be paired with the receiver.**

Band - Select either the **5GHz** or **6GHz** wireless frequency. The 5GHz frequency provides more channels but is utilized by more devices, resulting in frequent interferences and video dropouts. The 6GHz frequency is less crowded than the 5GHz frequency, resulting in faster connections and less interference. **NOTE: The 6GHz band is intended for indoor use only.**

Enable Broadcast Mode (Bolt 6 XT MAX units only)- Broadcast Mode allows you to transmit to multiple receivers simultaneously (non-DFS frequencies only), while also extending your Bolt 6's transmission range.

- **Broadcast Mode Disabled** (Standard Multicast Mode) - Transmitter and connected receiver(s) coordinate and maintain two-way communication with each other to optimize frequency usage and video transmission.
- **Broadcast Mode Enabled** - Data uplink channel is disabled, allowing the transmitter to connect to an unlimited number of receivers, as long as they have already been paired. To achieve even better range performance, attach the receiver to your Bolt Panel Antenna while in Broadcast Mode. **NOTE:** Bolt 6 XT 750 and 1500 receivers will not link to a Bolt 6 XT MAX transmitter in Broadcast Mode, even if they were previously paired. You must use a Bolt 6 XT MAX receiver. Otherwise, the receiver's OLED will display **Broadcast Not Supported**.

Enable Fixed Frequency - Fixed Frequency Mode allows your transmitter to designate a specific non-DFS channel within the selected wireless region for use, providing a stronger connection in difficult environments. There are two options for Fixed Frequency Mode:

1. Non-DFS and non-6GHz channels
2. Specific non-DFS 5GHz channels

NOTE: By default, Bolt 6 XT will select the lowest available frequency from the Frequencies list if one has not been selected beforehand.

Bandwidth - Choose between 20MHz and 40MHz bandwidth options

Frequencies - Select which frequency to use (determined by **Fixed Frequency Mode** selection).

Video Quality - The Video Quality menu lets you adjust the balance between your signal's maximum range and quality according to the number of antennas used to transmit fine information. Bolt 6 XT has several picture quality levels that vary based on the lowest quality link or the furthest receiver.

- **Auto Mode** - (*Default*) Transmitter automatically determines how many fine antennas are needed based on the range and signal quality.
- **Longer Distance Mode** - (*One fine antenna*) Maintains the maximum range in situations where other sources of interference might be present, but will slightly reduce your video signal's maximum quality.
- **Better Quality Mode** - (*Two fine antennas*) Maintains higher signal quality but reduces the maximum range.
- **Best Quality Mode** - (*Three fine antennas*) Ideal for complex, high-contrast scenes that require the highest possible quality.
- **Low Power Mode** - (*One fine antenna with shorter range*) Reduces the transmitter's total power consumption by about 1.5W and may reduce any unwanted interference in multi-system environments.

Video Settings

HDMI/SDI Output (RX only) - Select the video output format. You can choose to match the video source's resolution (**Same As Input**) or choose from the resolutions listed. If using the receiver with a recorder or monitor that is sensitive to video signal changes, select **Continuous Output** to ensure the signal stays constant even if the link is interrupted. Note that this adds a small delay to the video output.

3D LUT Settings (RX Only) - The 3D LUT settings menu contains specific looks that can be applied to your video output that either match or simulate how the video will appear after editing, along with options for how they are overlaid on your video output (**Full** or **Split-screen**).

- **3D LUT Presets** - Select a specific look from the list of 3D LUT presets.
- **3D LUT Mode** - Select whether the look is applied to the entire video output (**Full Screen**) or half (**Split Screen**).

Video OSD Settings (RX Only) - Choose when to display the OSD.

- **Never show** - Disable OSD.
- **Show when operating** - Hide OSD until it is activated by the joystick.
- **Show when no video** - Display the OSD when there is no video feed; hide the OSD when video appears (default).

- **Always show** - Always display OSD unless temporarily deactivated by the joystick.

Display Settings - Use the Display Settings to control the OLED display operation. By default, the OLED display will invert every 30 minutes.

Tools

SDI Eye Pattern (TX only) - The SDI Eye Pattern provides a graphical display of the SDI signal coming from the camera to the transmitter, and is useful in determining the amount of interference present. The size of the "eye" displayed on the front panel indicates the quality of the SDI signal. The bigger the size of the eye pattern is, the better the SDI signal.

Signal Quality Graph (RX Only) - The Signal Quality Graph indicates the quality and reliability of the signal being received according to the amount of interference that is present between the RX and TX. Signal Quality is represented in percentages:

- Figures below 30% indicate **poor** signal quality
- Figures between 30% and 45% indicate **fair** signal quality
- Figures above 45% indicate **good** signal quality

Spectrum Analyzer (RX Only) - The built-in Spectrum Analyzer provides a visual indication of channel noise and saturation across the entire available frequency range. Move the Menu joystick left and right to select a frequency. Frequencies are represented by bars; the higher the bar, the more congested that frequency is.

Test Pattern (RX Only) - This menu allows you to select a video resolution format to output a test pattern over HDMI or SDI. Select a specific output resolution from the resolutions list.

Advanced/System Settings

Lock Keypad - The Lock Keypad feature prevents the menu joystick from being used to avoid any accidental or unauthorized configurations. There are two ways to lock the keypad:

- Navigate to **Advanced Settings** via the front panel and select **Lock Keypad**.
- Press and hold the menu joystick upward for 5 seconds.

To unlock, press and hold the menu joystick upwards for five seconds or until the display reads "**KEYPAD UNLOCKED.**"

HDMI (RX only) - Bolt 6 supports all HDMI output modes. You can select from one of the following options:

- Auto
- RGB 8bit
- RGB 10bit
- YCbCR 4:4:4 8bit
- YCbCR 4:4:4 10bit
- YCbCR 4:2:2 10bit
- YCbCR 4:2:0 8bit
- YCbCR 4:2:0 10bit

Audio (RX only) - Configure Bolt's Audio settings. If **Beep on REC** is activated, you will hear a short tone whenever the camera begins or stops recording. The **Mute Settings** allow you to completely mute audio or only mute audio while recording.

Bluetooth - Use the Bluetooth menu to enable or disable Bluetooth communication. **NOTE: Bluetooth is enabled by default.**

- **Enable Bluetooth** - Allows transmitter and receiver to be paired and communicate with the Bolt App.
- **Use Bluetooth PIN** - Enables the use of a PIN for authentication when using the Bolt App.
- **Change PIN** - Press the Menu joystick towards the right to change the Bluetooth PIN

Background Color (RX only)- The Background Color feature allows you to select a screen color to be displayed on the monitor when there is no video being received from the transmitter. This is a useful tool that indicates to the crew that a signal has been dropped and the TX and RX need to be synced again.

Reset All Settings - Reset all configurable options to their factory settings.

Additional Information

Device Info - Displays the model and serial number of the device

Firmware Versions - Displays the current firmware versions for all device components.

Regulatory - Displays all compliance certifications and certification markings related to radio frequencies used by the TX and RX to communicate. For complete regulatory information and declarations of conformity, please visit the [Regulatory Information](#) section.

Bolt App

Use the Bolt App to remotely manage and monitor every parameter of Bolt 6 including pairing, frequency selection, and 3D LUTs.

CONNECT VIA BLUETOOTH

1. Download the Bolt App.
2. Enable Bluetooth on your iOS or Android device.
3. Navigate to the Bluetooth menu on both the transmitter and receiver, then select **Enable**.
4. Open the Bolt App from your iOS or Android device, then tap the **Bolt Devices** button.
5. Select the device(s) you want to pair or monitor.

Transmitter Status Display



- **Settings** (Descriptions listed in [Transmitter Menu](#) section) - Tap the settings button on the top right corner of the screen to customize the transmitter's various settings.
- **Status** - Displays the current status of:
 - Video Input
 - Network Status
 - Connected Receivers
 - Current Frequency
 - Quality
 - Temperature
 - Camera Recording
 - Region
 - Bandwidth
 - OSD name

Receiver Status Display

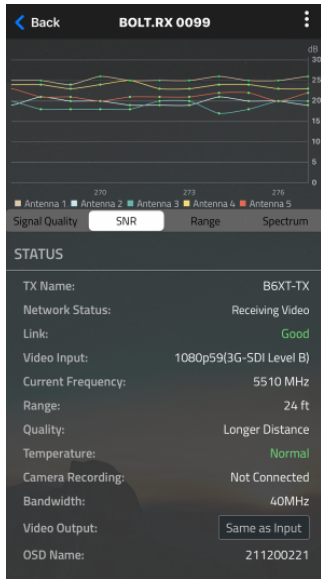

- **Settings** (Descriptions listed in [Receiver Menu](#) section) - Tap the settings button on the top-right corner of the display to customize the receiver’s various settings such as the output format, audio, display, and OSD.
- **Signal Quality** - Determine the quality and reliability of the signal being received.
- **SNR (Signal to Noise Ratio)** - Compare the signal power level to the noise power level from the antennas.
- **Range Analyzer** - Displays the transmission distance between the transmitter and receiver.
- **Status** - Displays the current status of:
 - TX Name
 - Network Status
 - Link
 - Video Input
 - Current Frequency
 - Range
 - Quality
 - Temperature
 - Camera Recording
 - Bandwidth
 - Region
 - Video Output
 - OSD name

Other Resources

- USER MANUAL: <https://guide.teradek.com/m/112641>
- FIRMWARE UPGRADE: <https://teradek.com/pages/downloads#bolt6>

Bolt 6 XT System



- | | |
|---------------------------------|-------------------------|
| A: RP-SMA connectors | G: USB-C port |
| B: 10-28V DC power input | H: OLED display |
| C: 5-Pin USB port | I: Menu joystick |
| D: HDMI input | J: Power switch |
| E: 12G-SDI output | K: HDMI output |
| F: 12G-SDI input | |

Receiver Antennas

This image illustrates the order of the receiver's antennas. The numbers below correspond to the antenna numbers in [Bolt App's](#) per-antenna SNR (Signal-to-noise ratio) graph, which can be used to troubleshoot signal quality issues. **Antenna 1** is closest to the video outputs, while **Antenna 5** is closest to the OLED screen.



Bolt 6 LT System



- A:** RP-SMA connectors
- B:** 6-28V DC power input
- C:** HDMI input
- D:** 3G-SDI output
- E:** 3G-SDI input
- F:** OLED display
- G:** Menu joystick
- H:** Power switch
- I:** USB port (not shown)
- J:** HDMI output

Receiver Antennas

This image illustrates the order of the receiver's antennas. The numbers below correspond to the antenna numbers in [Bolt App's](#) per-antenna SNR (Signal-to-noise ratio) graph, which can be used to troubleshoot signal quality issues. **Antenna 1** is closest to the video outputs, while **Antenna 5** is closest to the OLED screen.



Bolt 6 LT-HDMI



- A:** RP-SMA connectors
- B:** 6-28V DC power input
- C:** 5-pin USB port
- D:** HDMI output
- E:** HDMI input
- F:** OLED display
- G:** USB-C port
- H:** Menu joystick
- I:** Power switch

Receiver Antennas

This image illustrates the order of the receiver's antennas. The numbers below correspond to the antenna numbers in [Bolt App's](#) per-antenna SNR (Signal-to-noise ratio) graph, which can be used to troubleshoot signal quality issues. **Antenna 1** is closest to the video outputs, while **Antenna 5** is closest to the OLED screen.



Bolt 6 Monitor Module (TX/RX)

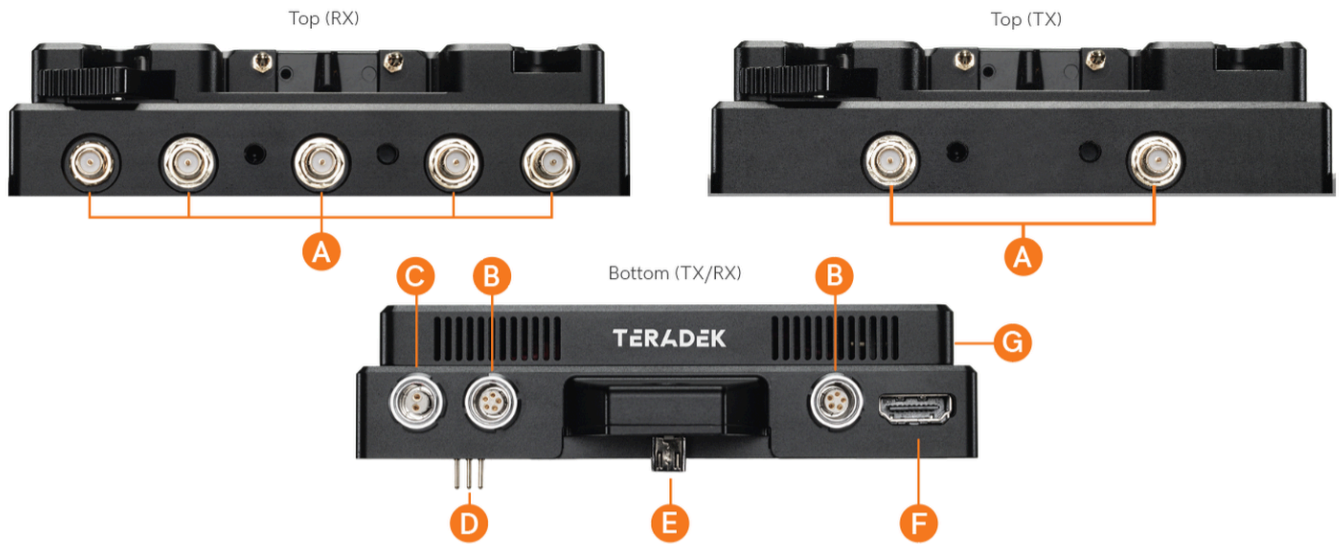

- A.** RP-SMA connectors
- B.** AUX input
- C.** 6-18V DC input
- D:** Compression pins

- E.** Micro USB
- F:** HDMI input/output
- G:** P-Tap input

Device Operation

- Keep the transmitter and receiver at close range for 60 seconds after powering on the devices. This allows them to scan for and select the best wireless frequency.
- For best results when using multiple Bolt systems in the same area, place the transmitters and receivers a few feet apart from each other.
- Operation of other wireless equipment may interfere with the Bolt. Try to separate other wireless transmitters and receivers as much as possible.

Power and Connect

Bolt 6 XT/LT

1. Connect power to the Bolt transmitter and receiver with the included A/C adapter, or if both devices are equipped with battery plate accessories, attach a compatible battery (Gold or V mount).
2. Connect the output from your video source to either the SDI or HDMI input on the Bolt transmitter.
3. Connect either the SDI or HDMI output from the Bolt receiver to the video input on your monitor.
NOTE: If mounting the receiver upright on a stand above the monitor, use a right-angle SDI adapter to relieve any strain caused by the weight of the cable, and to avoid damaging the SDI output's internal connectors.
4. Move the power switches on both the transmitter and receiver to the ON position.

Bolt 6 Monitor Modules

1. Remove the battery plate from the back.
2. **TX Module** - Detach the cover plate from the back of the Bolt 4K Monitor Module to expose the JST connector.
RX Module - Remove the battery plate from the back of the Bolt 4K Monitor Module to expose the two top mounting holes.
NOTE: There is no need to disconnect the JST connector.
3. Place the monitor module firmly against the back of the Smart 7 monitor. Ensure the two top mounting holes, connector pins, and micro USB align with their corresponding terminals.
4. Insert two M3 socket-head screws through the two top mounting holes on the monitor module and into the back of the monitor (**see image below**). **DO NOT OVER-TIGHTEN.**
5. **TX Module - (OPTIONAL)** Attach an L-series battery plate to the monitor module, then tighten the four Phillips screws.
RX Module - Reattach the battery plate to the monitor module, then tighten the four Phillips screws.
6. Insert, then tighten the 1/4"-20 hex screw to secure the monitor module assembly against the back of the monitor (**see image below**). **DO NOT OVER-TIGHTEN.**
7. Attach a compatible battery to the battery plate (**optional for TX Module**), or connect power to the module's 6-18V DC input using the included A/C adapter.
NOTE: Ensure the A/C adapter is connected to the module and NOT the monitor.
8. Turn the system on by pressing and holding down the monitor's power button.

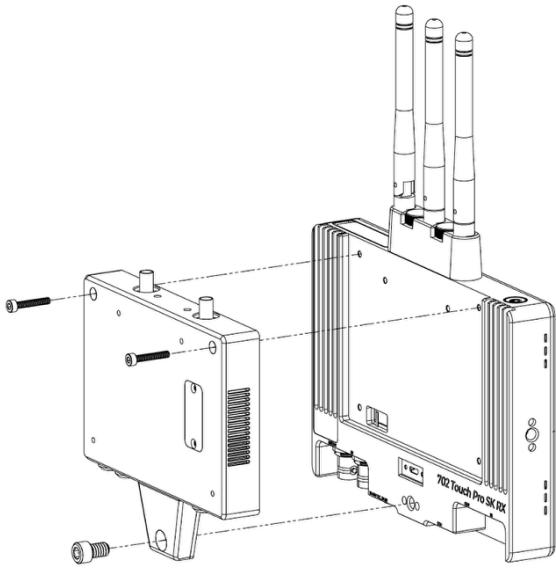

Power Cables

2-Pin Power Connector

Bolt devices use a locking 2-pin power connector similar to the 0B 302 series LEMO connector.

2-Pin Power Connector Pin Out	
Pin	Description
1*	GND
2	+DC

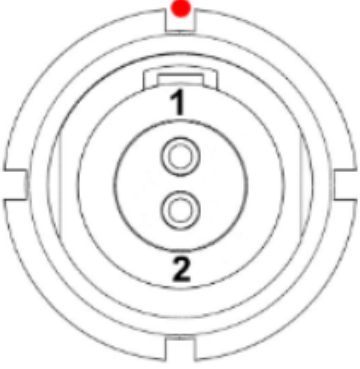

* Pin 1 is closest to the red dot on the connector.

Input Voltage: 10-28V DC

Max Power Consumption: 20W (TX) and 18W (RX)

Custom/3rd Party Cables

- Test the power cable polarity with **ONLY** the power cable connected to Bolt. Do not connect video cables.
- Check the power cable for shorts and proper grounding.

12G-SDI Input/Output Cables (Bolt 6 XT)

Bolt 6 XT units require the use of 12G-SDI cables to reliably transport 12G video signals, and are included as a standard item. Ensure that your cables are rated for compatibility with your camera's output.

CAUTION:
Using a reverse polarity or improperly-constructed power cable can damage the product and is not covered under warranty. To prevent the inputs from being damaged, best practice is to

plug in the power cable first, THEN connect the video cable from the camera before powering on the TX unit.

Wireless Configuration

Bolt 6 contains several wireless configuration options that allow the system to work at its best in different environments. The system is designed to work adequately using its default, automatic settings, but they may not be ideal for all situations. This section details all available wireless configuration options for the transmitter and receiver.

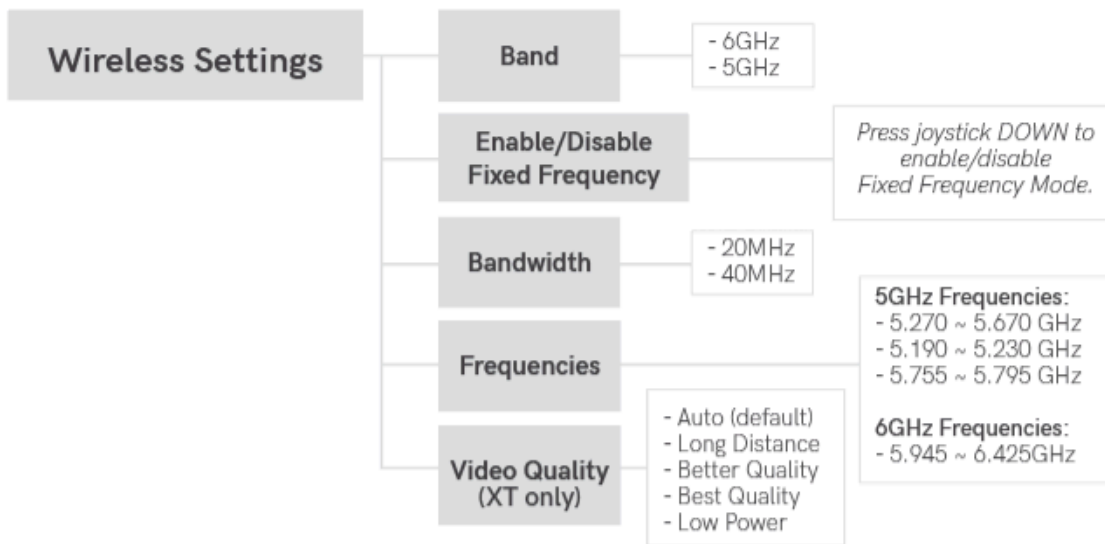

Wireless Settings

Band

The Band menu lets you select either **5GHz** or **6GHz**, frequency bands. The 5GHz frequency allows for higher total output power and backward compatibility with Bolt 6 devices but is more likely to experience interference from other wireless devices (Wi-Fi routers, cell phones, IoT devices, and other wireless video systems), resulting in frequent interference and video dropouts.

The 6GHz (U-NII-5) band is virtually vacant compared to the 5GHz band, and although the allowed output power is lower, it should offer better connection stability with fewer interruptions. The 6GHz frequency, intended for outdoor use only, is currently available in the US and Canada, with more countries opening the 6GHz frequency in 2023. For all available frequencies, refer to the [FREQUENCIES BY REGION](#) chart.

Enable Broadcast Mode (Bolt 6 MAX units only)

Enabling Broadcast Mode improves the system's maximum transmission range by allowing Bolt MAX systems to operate without any back-channel communication between the receiver and transmitter and reduces any interference.

- **Broadcast Mode Disabled** (Standard Multicast Mode) - Transmitter and connected receiver(s) coordinate and maintain two-way communication with each other to optimize frequency usage and video transmission.
- **Broadcast Mode Enabled** - This allows the transmitter to connect to an unlimited number of receivers, as long as they have already been paired. To achieve even better range performance, attach the receiver to your Bolt Panel Antenna while in Broadcast Mode.

NOTE: Bolt 6 XT/LT 750 and 1500 receivers will not link to a Bolt 6 XT/LT MAX transmitter in Broadcast Mode, even if they were previously paired. You must use a Bolt 6 MAX receiver. Otherwise, the receiver's OLED will display **Broadcast Not Supported**.

Enable Fixed Frequency

Fixed Frequency Mode bypasses any automatic frequency switching logic, allowing your Bolt 6 system to always attempt to connect on a specified frequency. Once a frequency is selected, the transmitter will only use that frequency. This allows the transmitter to link/reconnect to the receiver much faster. After enabling Fixed Frequency mode, navigate to **Frequencies** and select a frequency within the selected wireless region (non-DFS frequencies only). There are two options for Fixed Frequency Mode:

1. Non-DFS and non-6GHz channels
2. Specific non-DFS 5GHz channels

For best results, ensure that both the transmitter and receiver have **Fixed Frequency Mode** enabled, and use the **Spectrum Analyzer** (on the receiver's front panel or the Bolt app) to search for the least congested frequency to use.

- **Fixed Frequency Mode Disabled** - Bolt 6 scans all available frequencies and repeatedly switches from one frequency to the next during transmission.
- **Fixed Frequency Mode Enabled** - Bolt 6 connects to one specific frequency.

NOTE: By default, Bolt 6 will select the lowest available frequency from the Frequencies list if one has not been selected beforehand.

Select Bandwidth

The Bandwidth menu lets you choose between 40MHz (default) and 20MHz operating modes. Ensure that both the transmitter and receiver are set to the same bandwidth with a resolution of up to 1080p60. For all available frequencies, refer to the **FREQUENCIES BY REGION** chart.

- **20MHz** - Reduces the amount of bandwidth by half, effectively doubling the number of usable frequencies while decreasing interference.
- **40MHz** - (*Default*) Increases the amount of bandwidth by bonding two 20MHz frequencies, allowing for faster transfer rates but increased interference.

NOTE: 20MHz mode supports HD/3G resolutions up to 1080p60. Resolutions up to 4k30 are also supported but downscaled to 1080p before transmission (4k50/59/60 is not supported).

Select Frequency

The Frequencies menu contains a list of all available frequencies. Bolt 6 will automatically select an operating frequency when multiple values are selected. If both the transmitter and receiver have **Fixed Frequency Mode** enabled, you can only select one frequency for Bolt 6 to use. Frequencies marked with (DFS) must be scanned for one minute before they can be used, but are typically less crowded. For all available frequencies, refer to the [FREQUENCIES BY REGION](#) chart.

Video Quality (Bolt 6 XT/LT Transmitters only)

The Video Quality menu lets you adjust the balance between your signal's maximum range and quality according to the number of antennas used to transmit fine information. Bolt 6 has three picture quality levels that vary based on the lowest quality link or the furthest receiver.

- **Auto Mode** - (*Default*) Transmitter automatically determines how many fine antennas are needed based on the range and signal quality.
- **Longer Distance Mode** - (*One fine antenna*) Maintains the maximum range in situations where other sources of interference might be present, but will slightly reduce your video signal's maximum quality.
- **Better Quality Mode** - (*Two fine antennas*) Maintains higher signal quality but reduces the maximum range.
- **Best Quality Mode (Bolt 6 XT only)** - (*Three fine antennas*) Ideal for complex, high contrast scenes that require the highest possible quality.
- **Low Power Mode (Bolt 6 XT only)** - (*One fine antenna with shorter range*) Reduces the transmitter's total power.

Wireless Configuration Recommendations

Bolt 6 can be used in many different situations that require you to configure the wireless settings to provide the optimal video transmission quality possible. The following table (**TX Video Quality Descriptions**) describes the Video Quality modes available on the TX. The table below (**Recommended Wireless Configurations**) illustrates some of the most common scenarios encountered while using the Bolt 6, along with recommended wireless settings that will provide you with the best video quality in those situations.

TX Video Quality Descriptions

VIDEO QUALITY MODES	DESCRIPTION
Auto Mode (Default)	In Auto Mode, the system will jump between the configurations listed below based on the range and signal quality - if you know your conditions won't change, you can set them manually.
Longer Distance Mode	Longer Distance Mode is best for outside use, especially in situations where other sources of interference might be present, but will slightly reduce your video signal's maximum quality.
Better Quality Mode	This mode is best for inside use, especially when there are other WiFi networks in the vicinity. Better Quality Mode maintains higher signal quality but reduces the maximum range.
Best Quality Mode	Best Quality Mode is ideal for complex, high-contrast scenes that require the highest possible quality. This mode is also best for inside use, especially when there are other WiFi networks in the vicinity.
Low Power Mode	Low Power Mode provides the best connection possible at extremely short distances by reducing the transmitter's total power consumption and any unwanted interference in multi-system environments.

Recommended Wireless Configurations

USER SCENARIOS	WIRELESS SETTINGS				
	Band	Broadcast Mode	Fixed Frequency	Bandwidth	Video Quality (TX)
Auto (Default)	5GHz	Disabled	Disabled	40MHz	Auto Mode

	WIRELESS SETTINGS				
USER SCENARIOS	Band	Broadcast Mode	Fixed Frequency	Bandwidth	Video Quality (TX)
Longest Range (No interference)	5GHz	Enabled w/ Panel Antenna	Optional	40MHz	Longer Distance Mode
Long Range (Busy RF)	6GHz	Enabled	Optional	40MHz	Longer Distance Mode
Short Range	6GHz	Optional	Enabled	40MHz	Auto or Best Quality Mode
Best Video Quality (4K)	6GHz	Disabled	Optional	40MHz	Auto or Best Quality Mode
Best Video Quality (HD)	6GHz	Disabled	Optional	40MHz	Auto or Best/Better Quality Mode
Multi-System* (Close Range)	6GHz	Disabled	Enabled	20MHz	Better Quality Mode
Multi-System* (Mid Range)	6GHz	Disabled	Enabled	20MHz	Longer Distance Mode
Multi-System* (Short Range)	6GHz	Optional	Optional	40MHz	Low Power Mode

* **Multi-System** scenarios refer to situations where multiple TX and RX paired systems are in use in the same vicinity as the system you are trying to configure.

Pairing and Unpairing

Bolt 6 devices purchased as a set (TX and RX) are paired by default, requiring no additional configuration. Bolt 6 devices purchased separately need to be paired using the device's front panel (OLED) menu, **Bolt Manager**, or the **Bolt App**. To pair your transmitter with multiple receivers, you will need to use either Bolt Manager or the Bolt App. **NOTE: Before starting either pairing process, ensure that both the transmitter and receiver have the same firmware version and have Bluetooth enabled.**

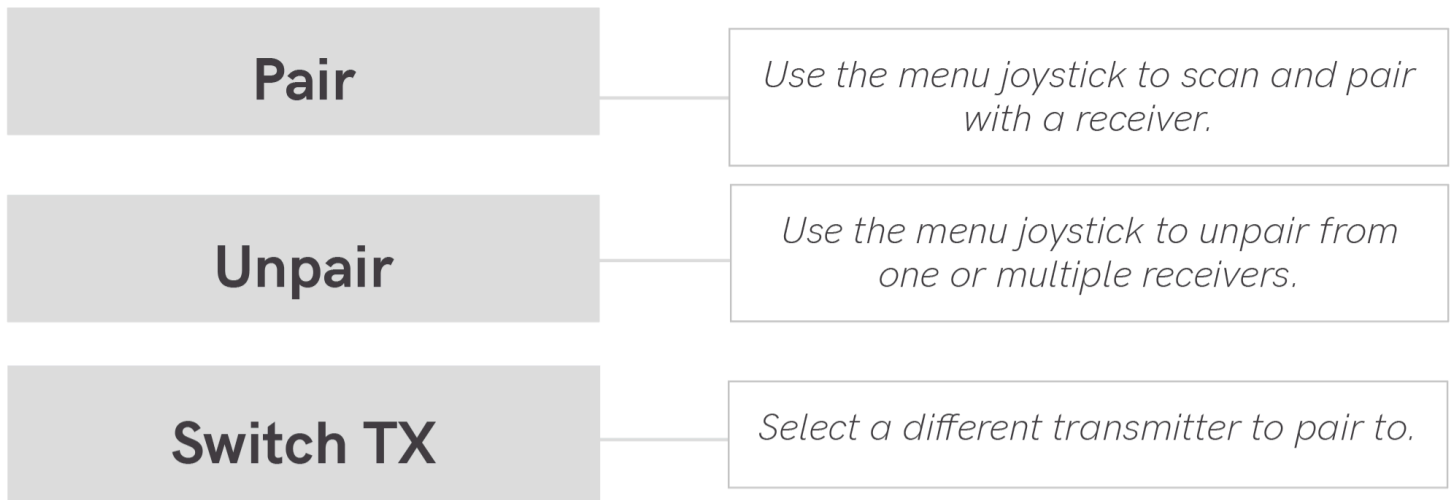

Pairing/Unpairing via the Front Panel

TO PAIR:

1. Using the Menu Joystick, navigate to the **Pair** menu on both the transmitter and the receiver.
2. Select Pair to begin the pairing process. The transmitter will begin scanning for a receiver within range and automatically pair to the receiver.
3. Once paired, the front panel will indicate whether or not Pairing is successful.

TO UNPAIR:

1. Navigate to the **Unpair** menu on either the transmitter and the receiver.
2. Select the transmitter/receiver you want to unpair. If you have multiple devices paired, you can select **Unpair All**.

PAIRING TIPS

If you're having trouble getting units to pair, we recommend keeping the transmitter and receiver six feet apart when pairing (if antennas are connected). Without antennas, they can be closer. Keep all other RF devices nearby turned off or out of range to ensure the transmitter and receiver are only detecting each other. To eliminate any chance of interference, perform the **Wired Pairing** process via Bolt Manager.

Pairing via Smart 7 Monitor (TX Module)

TO PAIR:

1. Swipe right on the monitor's touchscreen, then tap on the **Settings** option once it appears.
2. Scroll back up and tap to select the **TERADEK BOLT 4K** option, then tap **Pair new receiver**.
3. Enable Pairing on the Bolt 6 receiver(s) or by selecting **Pair** on the front panel menu. The Monitor Module will begin scanning for receivers to automatically pair with. **Note: You can pair the transmitter with up to six receivers at one time.**
4. Once the devices are paired successfully, tap **Accept** to dismiss the menu. If pairing fails, try again.

TO UNPAIR:

1. Swipe right on the monitor's touchscreen, then tap on the **Settings** option once it appears.
2. Scroll down the left column and select the **TERADEK BOLT 4K** option, then tap **Unpair ALL receivers**.

Pairing via Smart 7 Monitor (RX Module)

TO PAIR:

1. Swipe right on the monitor's touchscreen, then tap on the **Settings** option once it appears.
2. Tap to select the **TERADEK BOLT 4K** option, then tap **Pair new transmitter (TX)**.
3. Enable Pairing on the Bolt 6 transmitter(s) by selecting **Pair** on the transmitter's front panel menu. The RX module will begin scanning for transmitters to automatically pair with. **Note: You can pair the receiver with up to six transmitters at one time.**
4. Once the devices are paired successfully, tap **Accept** to dismiss the menu. If pairing fails, try again.

TO UNPAIR:

1. Swipe right on the monitor's touchscreen, then tap on the **Monitor Settings** option once it appears.
2. Tap to select the **TERADEK BOLT 4K** option, then tap **Unpair transmitter(s)**.

Pairing/Unpairing via the Bolt App

TO PAIR:

1. Open the Bolt App from your iOS or Android device, then tap the **Pairing** button.
2. Select the transmitter you wish to pair, then tap the **Next** button.
3. Select the receiver(s) you wish to pair with the transmitter, then tap the **Pair!** button. The Bolt App will indicate when the pairing process is complete.

TO UNPAIR:

1. Open the Bolt App from your iOS or Android device, then tap the settings button (3 dots) on the top right corner of the screen.
2. Enter the **Pairing** menu, select the receiver(s) you wish to unpair, then tap the **Unpair** button.

Wired Pairing via Bolt Manager

TO PAIR:

1. Connect both the transmitter and receiver(s) to your computer (Windows/Mac) via USB.
2. Open Bolt Manager, select the **Pairing** tab, then tap the **Wired Pairing** button.
3. Select the devices you want to pair, then click the **Pair Devices** button. Bolt Manager will indicate whether or not Pairing is successful.

TO UNPAIR:

1. Connect both the transmitter and receiver(s) to your computer (Windows/Mac) via USB.
2. Open Bolt Manager, select the **Pairing** tab, then tap the **Unpair All** button.

Switch TX (RX only)

Bolt 6 receivers can pair with up to four transmitters at a time. **Switch TX** allows you to quickly switch from one paired transmitter's camera feed to another paired transmitter. This feature is especially useful in multi-camera situations when you need to switch to a different camera's view mid-shoot, without having to perform the pairing process every time. The Switch TX feature can be found in the main menu. **NOTE: The transmitter(s) need to first be paired with the receiver.**

Video Settings Configuration

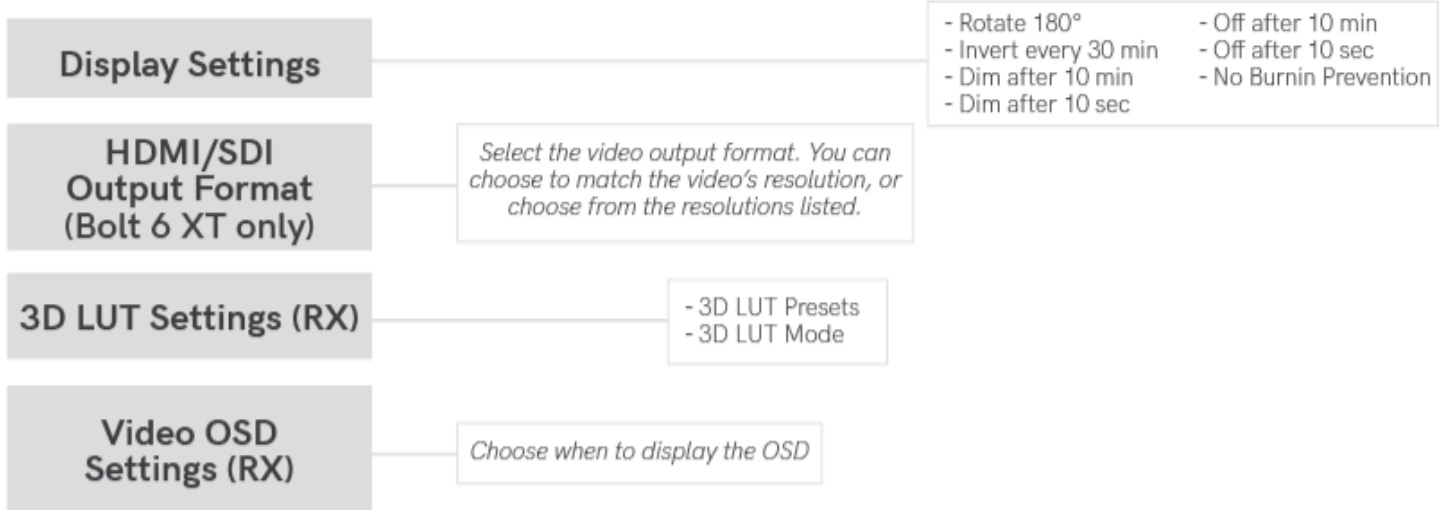

Display Settings

Use the Display Settings to control the OLED display operation. By default, the OLED display will invert every 30 minutes. You can set the display to invert every 30 minutes (lengthens the display life), or it can dim or turn off after either 10 minutes or 10 seconds.

- **Rotate 180°**
- **Invert every 30 min**
- **Dim every 10 min**
- **Dim after 10 sec**
- **Dim after 10 min**
- **Off after 10 sec**
- **No Burnin Prevention**

HDMI/SDI Output (Bolt 6 XT Receiver)

You can choose to match the video source's resolution (**Same As Input**) or choose from the resolutions list. If using the receiver with a recorder or monitor that is sensitive to video signal changes, select **Continuous Output** to ensure the signal stays constant even if the link is interrupted. Keep in mind that selecting Continuous Output adds a small delay to the video output. Selecting **SD, HD, or 6G-UHD** matches the video source's frame rate while adjusting the resolution. This is useful for when you need to down-convert a 4K video to display on an HD monitor.

- **Continuous Output** - Video signal output stays constant when using a monitor or recorder that is sensitive to video signal changes.
- **Same as Input** - Matches the transmitter's video source resolution.
- **SD** - Matches the TX frame rate and outputs SD resolution.
- **HD** - Matches the TX frame rate and outputs 1920x1080p.
- **6K-UHD** - Matches the TX frame rate and outputs 3840x2160.
- **Resolutions List** - Select a specific output resolution:
 - 4K (DCI) - 23.98/24/25/29.97/30/50/59.94/60
 - 4K (UHD) - 23.98/24/25/29.97/30/50/59.94/60
 - 1080p - 23.98/24/25/29.97/30/50/59.94/60
 - 1080psf - 23.98/24/25/29.97/30
 - 1080i - 50/59.94/60
 - 720p - 50/59.94/60
 - 480p - 50/59.94 (via HDMI ports only)

3D LUT Settings (Bolt 6 XT/LT Receiver)

The 3D LUT settings menu contains specific looks that can be applied to your video output that either match or simulate how the video will appear after editing, along with options for how they are overlaid on your video output (**Full** or **Split-screen**). Additional color preset files can be added and saved from your computer using [BOLT MANAGER](#).

- **3D LUT Presets** - Select a specific look from the list of 3D LUT presets.
- **3D LUT Mode** - Select whether the look is applied to the entire video output (**Full Screen**) or half (**Split Screen**).

Video OSD Settings (Bolt 6 XT/LT Receiver)

Choose when to display the OSD.

- **Never show** - Disable OSD.
- **Show when operating** - Hide OSD until it is activated by the joystick.
- **Show when no video** - Display OSD when there is no video feed; hide OSD when video appears (default).
- **Always show** - Always display OSD unless temporarily deactivated by the joystick.

Tools

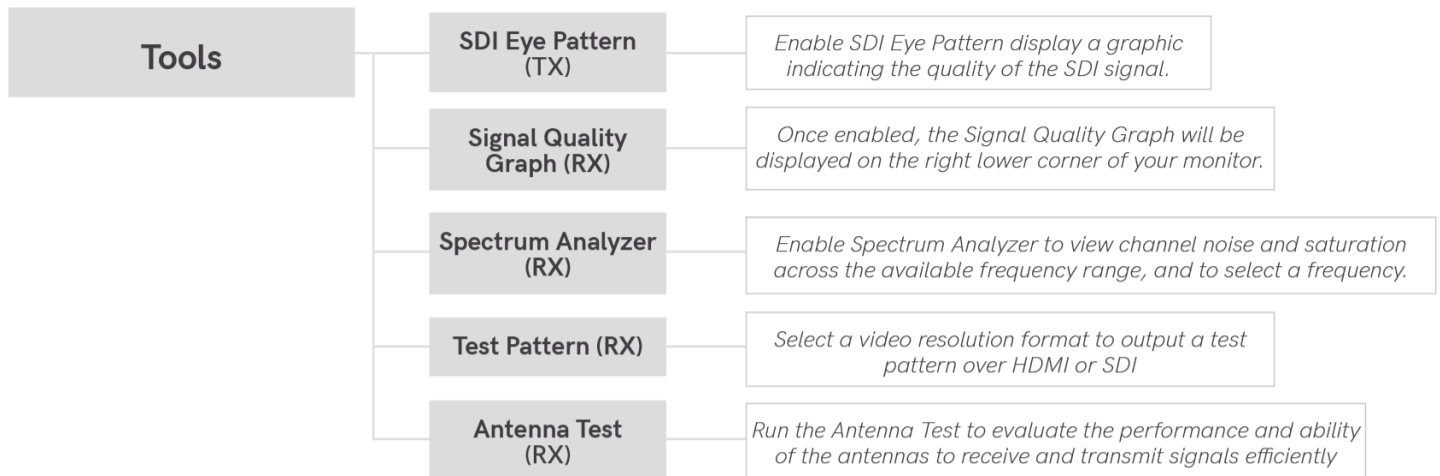

SDI EYE PATTERN (TX)

The SDI Eye Pattern provides a graphical display of the SDI signal coming from the camera to the transmitter, and is useful in determining the amount of interference present, or if the SDI cable is damaged. The size of the "eye" displayed on the front panel indicates the quality of the SDI signal. The bigger the size of the eye pattern is, the better the SDI signal.

SIGNAL QUALITY GRAPH (RX)

The Signal Quality Graph indicates the quality and reliability of the signal being received according to the amount of interference that is present between the RX and TX. When enabled, the graph will be displayed on the right lower corner of your monitor. Signal Quality is represented in percentages:

- Figures below 30% indicate **poor** signal quality
- Figures between 30% and 45% indicate **fair** signal quality
- Figures above 45% indicate **good** signal quality

SPECTRUM ANALYZER (EXCEPT BOLT 6 LT-HDMI)

The built-in Spectrum Analyzer visually indicates channel noise and saturation across the entire available frequency range. Move the Menu joystick left and right to select a frequency.



Frequencies are represented by bars; the higher the bar, the more congested that frequency is. Bars without a dot (1) indicate the frequency is not as saturated and can be used. Bars with a dot (2) indicate the frequency is too saturated to connect to. Faded bars (3) represent a frequency that is unavailable for use due to restrictions in particular regions.

TEST PATTERN (RX)

The Test Pattern menu allows you to select a video resolution format to output a test pattern over HDMI or SDI.

- **Resolutions List**- Select a specific output resolution:
 - **4K** - 23.98/24/25/29.97/30/50/59.94/60
 - **1080p** - 23.98/24/25/29.97/30/50/59.94/60
 - **1080psf** - 23.98/24/25/29.97/30
 - **1080i** - 50/59.94/60
 - **720p** - 50/59.94/60
 - **480p** - 59.94/576p - 50 (via HDMI ports only)
 - **480i** (NTSC)
 - **576i** (PAL)

ANTENNA TEST (RX ONLY)

The Antenna Test option allows you to evaluate the performance and ability of Bolt's antennas to receive and transmit signals efficiently. Before beginning the Antenna Test, ensure that there is a good link between the RX and TX and that all the antennas are attached correctly.



Perform Antenna Test

1. Attach antennas to both the TX and RX. Ensure that the antennas are tightened and secured to the device.
2. Ensure that the TX and RX are paired. If not, visit the [Pairing](#) section for instructions on pairing your devices.
3. Place the TX and RX at least 5 feet apart from each other.
4. Power on both units and allow them to link. The OLED will display one of the following messages:
 1. **NO VIDEO** - No video source is connected.
 2. **SENDING VIDEO/RECEIVING VIDEO** - A video source is connected.
5. From the RX front panel main menu, navigate to **TOOLS>Antenna Test**, then select **NEXT**. The Front panel will display **TEST IN PROGRESS** until the test is complete.
6. If the antenna test is passed, the OLED will display **TEST PASSED**. If the antenna test fails, the OLED will display an antenna table that indicates which antenna(s) have failed (see image below).

ANTENNA MAPPING

The antenna indicators displayed after a failed Antenna Test correspond with the antennas on your TX and RX units. Antenna 1 is closest to the video outputs, while Antenna 4/5 is closest to the OLED screen.

OLED DISPLAY



DESCRIPTION

TX Failed Symbols:	✓	X	X	✓	✓
TX Antennas:	4	3	2	1	Rx
RX Failed Symbols:	X	✓	✓	✓	✓
RX Antennas:	5	4	3	2	1

The Antenna test results can be read as follows:

- **TX ANT:** Lists all of the transmit antennas. 2 or 4 depending on the TX (Bolt LT only uses 2 transmit antennas), and one for the backchannel antenna at the RX (far right).
- **RX ANT:** Lists all of the RX antennas, from left-to-right starting with the antenna closest to the front panel.
- **PowAMP:** This is the result of a self-test on the RF power amplifiers for each transmit antenna. Similar to the TX antennas, there is one for each antenna on the TX (2 or 4), and one for the RX backchannel antenna at the far right.

If any of the antennas report an 'X' indicating a failure, check that the physical antenna is not damaged, the antenna is connected tightly, and there are no obstructions inside the antenna connector. If there is an X for any of the PowAMP readings there may be physical damage to the product. Get in touch with Teradek Support to troubleshoot.

Advanced Settings

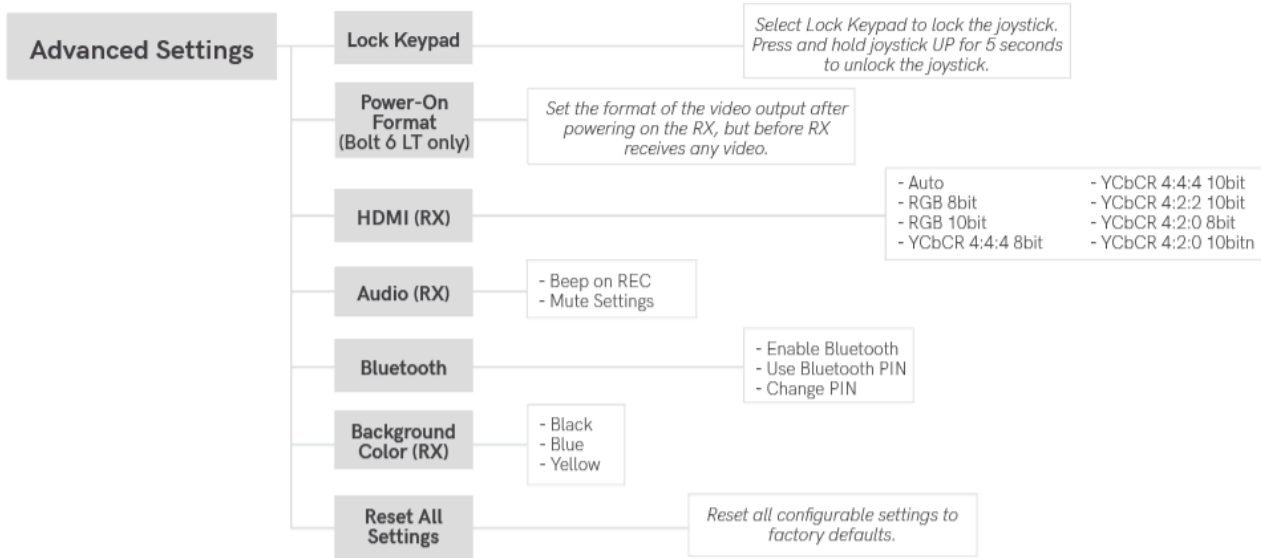

LOCK KEYPAD

Enabling the Lock Keypad feature prevents the menu joystick from being used to avoid any accidental or unauthorized configurations. There are two ways to lock the keypad:

- Navigate to **Advanced Settings** via the front panel and select **Lock Keypad**.
- Press and hold the menu joystick upward for 5 seconds.

To unlock, press and hold the menu joystick upwards for five seconds or until the display reads **"KEYPAD UNLOCKED."**

POWER-ON FORMAT

Power-On Format sets the video output format after power-up and before RX receives any video. This allows your receiver to maintain the same resolution that was applied before the unit is turned off.

HDMI (RX only)

Bolt 6 supports all HDMI output modes. You can select from one of the following options:

- **Auto**
- **RGB 8bit**
- **RGB 10bit**
- **YCbCr 4:4:4 8bit**
- **YCbCr 4:4:4 10bit**
- **YCbCr 4:2:2 10bit**
- **YCbCr 4:2:0 8bit**
- **YCbCr 4:2:0 10bit**

AUDIO (RX only)

Configure Bolt's Audio settings. If **Beep on REC** is activated, you will hear a short tone whenever the camera begins or stops recording. The **Mute Settings** allow you to completely mute audio or only mute audio while recording.

- **Beep on REC** - Short tone when the camera begins or stops recording
- **Mute Settings**- Select an option:
 - Off
 - Mute while recording
 - On

BLUETOOTH

Use the Bluetooth menu to enable or disable Bluetooth communication.

- **Enable Bluetooth** - Allows transmitter and receiver to be paired and communicate with the Bolt App.
- **Use Bluetooth PIN** - Enables the use of a PIN for authentication when using the Bolt App.
- **Change PIN** - Press the Menu joystick towards the right to change the Bluetooth PIN

NOTE: Bluetooth is disabled by default. To configure your Bolt 6 devices via the Bolt App, you must first enable Bluetooth.

BACKGROUND COLOR (RX only)

The Background Color feature allows you to select a screen color to be displayed on the monitor when there is no video being received from the transmitter. This is a useful tool that indicates to the crew that a signal has been dropped and the TX and RX need to be synced again.

RESET ALL SETTINGS

Reset all configurable options to their factory settings.

Info

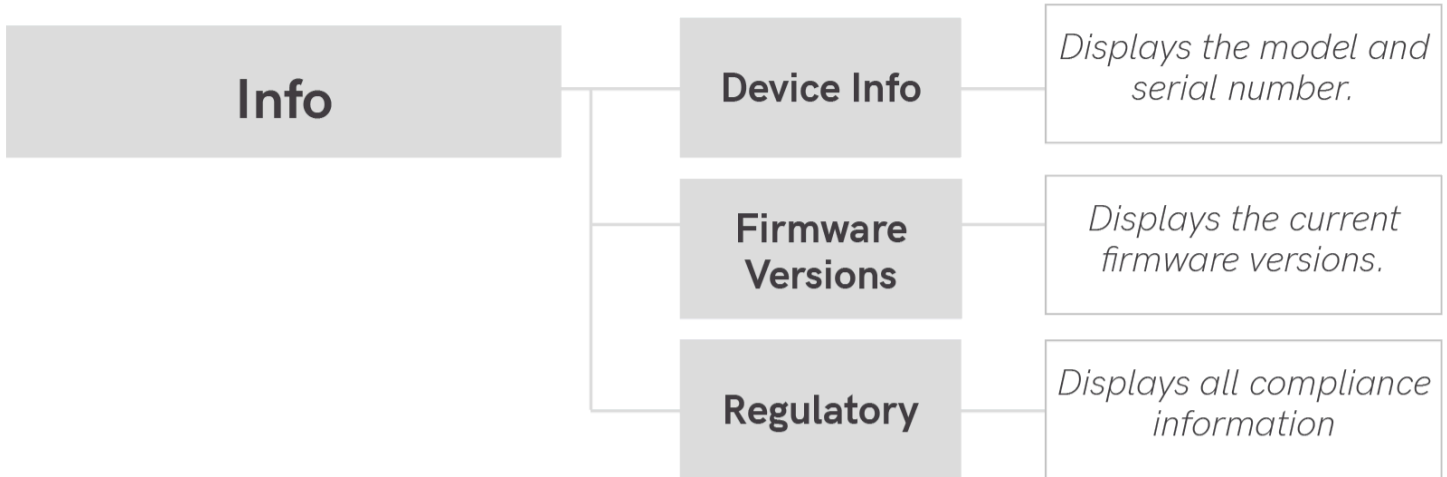

DEVICE INFO

Reset all configurable options to their factory defaults.

FIRMWARE VERSIONS

Displays the current firmware versions for all device components.

REGULATORY

Displays all compliance certifications relating to radio frequencies used by the TX and RX to communicate.

For complete regulatory information and declarations of conformity, please visit the [Regulatory Information](#) section.

Bolt Manager

With Bolt Manager, you can configure all of your Bolt 6 devices at once. Available as software for Windows and Mac, Bolt Manager allows you to pair multiple receivers to your transmitter, select frequencies, load 3D LUTs, and perform firmware upgrades.

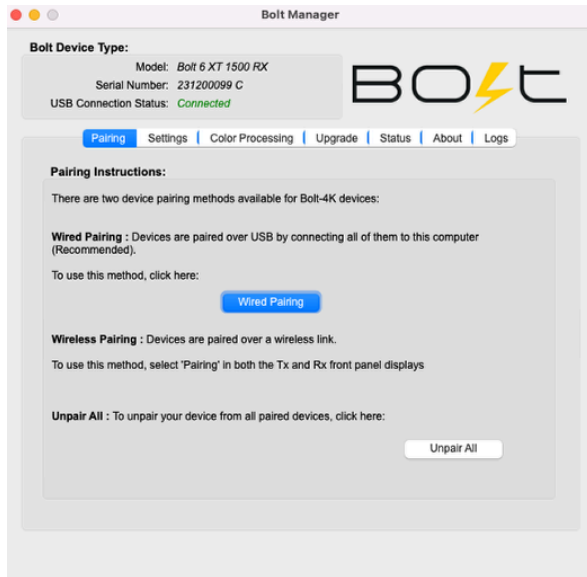

CONFIGURATION OPTIONS

NOTE: Available configuration settings will differ between Bolt models.

- **Pairing** - Pair or unpair your devices.
- **Settings** - Select the operating region (TX) and modify the RX/TX name.
- **Color Processing** - Allows you to apply 3D LUTS to the receiver's video output.
- **Upgrade** - Update your devices with the latest firmware.
- **Status** - Displays detailed information about configuration and update statuses.
- **About** - Displays the software version and License Agreement.
- **Logs** -

COLOR PROCESSING

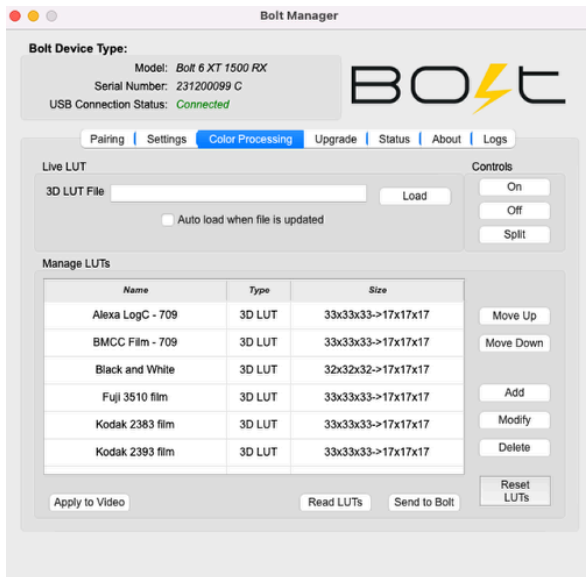

Color processing allows users to apply 3D LUTs directly to the receiver's video output or to add, remove, and modify up to 16 LUTs stored in Bolt 6's memory.

Live LUT - Click **Load** and browse for a 3D LUT file to apply to the video output. The following file formats are supported:

- **.dat** (DaVinci Resolve)
- **.3dl** (Assimilate Scratch)
- **.cube** (DaVinci Resolve)
- **.lut** (Pomfort LiveGrade)
- **.mga** (Final Cut)

Select **Auto load when file is updated**. The LUT file will be re-read and applied to the video automatically whenever it is updated on your computer.

Manage LUTs - The LUT manager allows you to select up to 16 3D LUT files to store on Bolt. LUTs can be rearranged, renamed, added, and removed using the corresponding buttons.

- **Sync** - Sync all currently loaded LUTs from the receiver's memory. After syncing, the LUTs will be displayed in the manager window.
- **Apply to Video** - Apply the selected 3D LUT file to the video output. Once applied, the LUT file can be turned **On**, **Off**, or applied to half the display using the **Split** option.
- **Read LUTs** - Read Bolt's storage and overwrite the contents of the LUT management window.
- **Send to Bolt** - Load your LUT presets to your device
- **Reset LUTs** - Reset Bolt's storage to default values. A number of pre-defined LUTs are contained in the default configuration.

UPGRADE

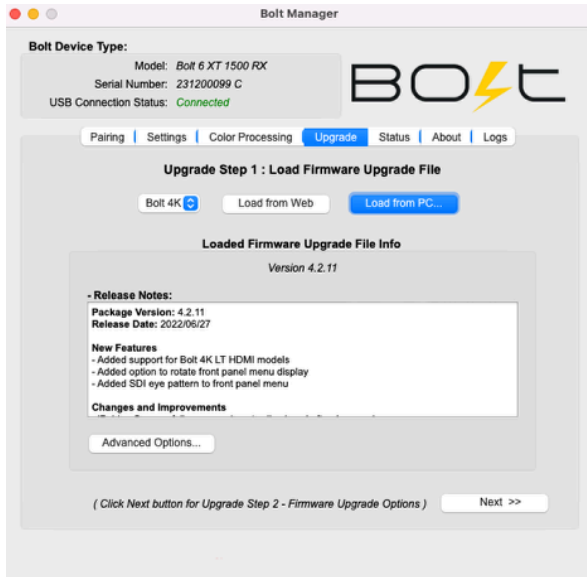

Teradek releases firmware updates periodically that add new features, improve performance, and fix vulnerabilities. To update Bolt 6, you'll need to load a firmware package into Bolt Manager.

- **Load from Web** - If you have an Internet connection, click **Load from Web** to download the latest firmware package from Teradek's servers.
- **Load from PC** - Click **Load from PC** if you have already downloaded the firmware package you wish to use. For latest firmware, visit: <https://www.teradek.com/pages/downloads#bolt4k>

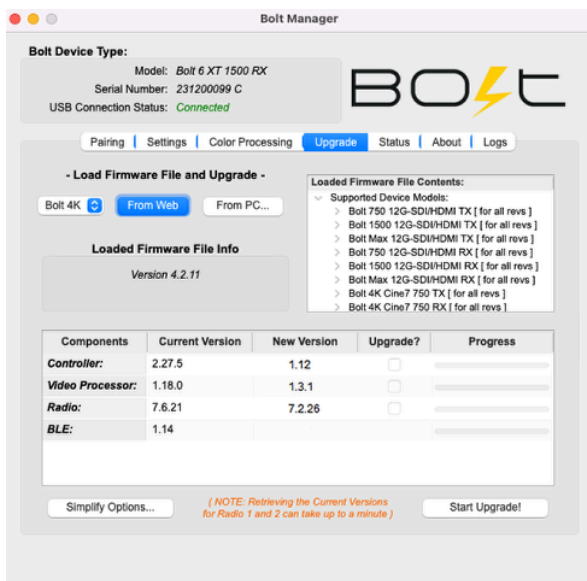

Once the firmware is loaded, and information about the package is displayed, click **Next** to proceed with the upgrade. You will then be presented with a list of device components and whether or not they are scheduled to be updated, along with two options:

- **Start Upgrade** - Update your Bolt 6 device(s) with the latest firmware version.
- **Advanced Options** - View detailed version information for each component and the firmware upgrade package components. The Advanced screen also allows users to select which components to upgrade.

Bolt App

Use the Bolt App to remotely manage and monitor every parameter of Bolt 6 including pairing, frequency selection, and 3D LUTs.

Connect via Bluetooth

1. Download the Bolt App.
2. Enable Bluetooth on your iOS or Android device.
3. Navigate to the Bluetooth menu on both the transmitter and receiver, then select **Enable**.
4. Open the Bolt App from your iOS or Android device, then tap the **Bolt Devices** button.
5. Select the device(s) you want to pair or monitor.

Transmitter Status Display

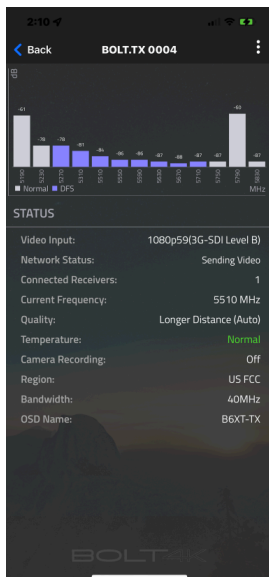

- **Settings** (Descriptions listed on [Transmitter Display Operation](#) section) - Tap the settings button on the top right corner of the screen to customize the transmitter's various settings.

- **Spectrum Analyzer** - Detects congestion in the area and determines which frequencies are available to use. Each bar represents a frequency, and the height represents the amount of congestion in that frequency; the higher the bar, the more congested that frequency is. Make sure to always select the shortest, least congested bar.
- **Status** - Displays the current status of:
 - Video input
 - Temperature
 - Network
 - Camera recording
 - Connected receivers
 - Region
 - Current frequency
 - Bandwidth
 - Quality
 - OSD name

Receiver Status Display

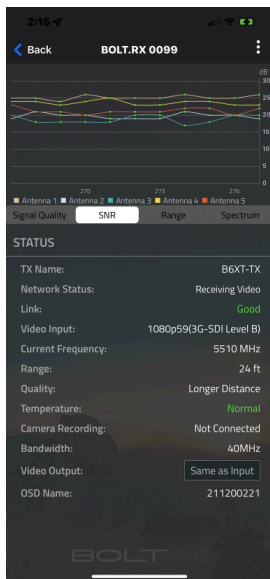

- **Settings** (Descriptions listed on [Receiver Display/OSD Operation](#) section) - Tap the settings button on the top-right corner of the display to customize the receiver's various settings such as the output format, audio, display, and OSD.
- **Signal Quality** - Determine the quality and reliability of the signal being received.
- **SNR (Signal to Noise Ratio)** - Compare the signal power level to the noise power level from the attached antennas.
- **Range Analyzer** - Displays the transmission distance between the transmitter and receiver.
- **Spectrum Analyzer** - Detects congestion in the area and determines which frequencies are available to use. Each bar represents a frequency, and the height represents the amount of

congestion in that frequency; the higher the bar, the more congested that frequency is. Make sure to always select the shortest, least congested bar.

- **Status** - Displays the current status of:
 - TX Name
 - Quality
 - Network
 - Temperature
 - Link
 - Camera recording
 - Video input
 - Bandwidth
 - Current frequency
 - Video output
 - Range
 - OSD name

Device Placement

Without Dual Mount

Bolt 6 XT/LT devices have a 1/4"-20 threaded hole (additional 3/8"-16 threaded hole on the receiver) on the bottom for mounting the included light stand adapter or any other mounting accessory.

! **CAUTION: DO NOT OVERTIGHTEN SCREWS INSERTED INTO THE 1/4"-20 OR 3/8"-16 THREADED HOLES.** Doing so can damage the device's chassis and internal components, voiding the warranty

Bolt 6 receivers can be mounted vertically on a light stand or monitor.

Bolt 6 transmitters mount vertically on a camera

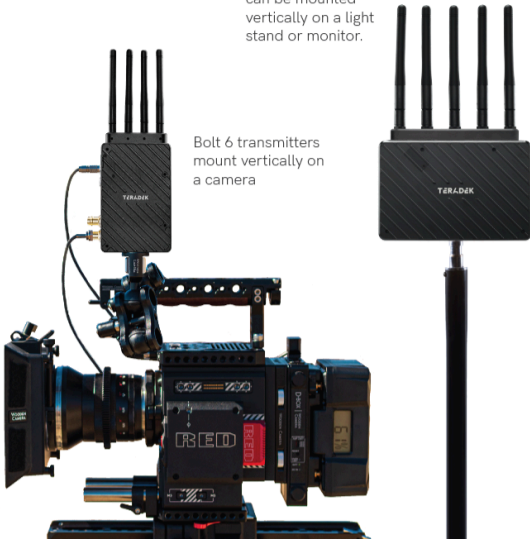

With Dual Mount

Depending on the model, Bolt 6 XT/LT devices are equipped with a dual mount battery plate that allows you to attach your device to either the back of a camera, monitor, or Bolt Panel Antenna.

Bolt 6 transmitters (w/dual mount) attaches to the back of a camera.



Antenna Orientation

Bolt 6 transmitters and receivers require the use of external antennas for basic operation. Different conditions will determine the type, orientation, and placement of the antennas.

Vertical and Horizontal Antennas

Vertical (V) antennas are included as a standard item with your Bolt 6, offering good performance in a wide variety of short-to-medium range situations when quick setup and flexibility are key. V antennas are ideal for achieving diversity indoors. Once you move outdoors with the V antennas, the RF signals travel in a similar or identical manner towards the receiver, weakening diversity. **Horizontal (H) antennas** were designed for use with the V antennas. H antennas cause the RF signal from the transmitter to propagate in a perpendicular manner compared to the vertical signal from the V antenna. The H+V antenna configuration helps to maintain the quality and performance of your video transmission, especially when your signal would otherwise begin to deteriorate due to noise and/or longer ranges.



Bolt 6 LT system with H+V configuration

Bolt 6 XT system with H+V configuration

Recommended Antenna Orientation

For most setups, the ideal position for the four TX antennas and the five RX antennas is perpendicular to the ground/horizontal plane so that they point straight up and down. If the transmitter is mounted at an angle or on its side, the antennas must also be arranged so that they point up. Pointing the antennas in any other direction re-orientes the radiation pattern and may reduce performance.



Examples of Bolt 4K TX in various mounted positions

Regulatory Information

PRODUCT INFORMATION

This product is designed to be compliant with rules and regulations in the country it is sold to and therefore is marked as required. These markings signify the countries the device is approved in. Operating the product without regulatory approval is illegal. Any changes or modifications to the product not expressly approved by Teradek could void the user's authority to operate the equipment and its regulatory approvals. Please make sure you use the latest revision of this document which is available at teradek.com.

SAFETY INSTRUCTIONS

- Keep these instructions in a safe and accessible place for future use.
- When operating this equipment, read and follow all the instructions in this manual.
- Do not open the unit.
- Do not block the air ventilation openings, and provide proper ventilation for the units to allow it to cool down during operation.
- Use only accessories/batteries/chargers specified or recommended by Teradek.
- When devices are switched ON, keep away at least 20 cm (7.9 in) from your body.
- People with pacemakers should **ALWAYS** keep the device at the listed distance from their pacemaker when turned ON. Should you have any reason to suspect that interference is taking place, you should turn your device OFF.
- Do not expose to moisture, excessive heat, or fire.
- Keep away from water and other liquids.
- Clean with a dry cloth only.
- Unplug this apparatus during lightning storms or when unused for long periods of time.

- To reduce the risk of fire or electric shock, refer servicing to qualified service personnel.
Declared maximum operating temperature: +40°C
- Please avoid electrostatic discharge from the antenna ports for proper operation

WARNING

Bolt 6 devices contain sensitive electronic components that can be damaged by electrostatic discharge (ESD). When handling, care must be taken so that the device is not damaged. Damage due to inappropriate handling is not covered by the warranty. For complete warranty information, please see the warranty card that arrived with the device, or visit www.teradek.com/pages/warranty-information.

MODIFICATIONS

Any changes or modifications could void the user's authority to operate the equipment and invalidate the regulatory approval.

ANTENNA REQUIREMENTS

The product is provided with approved antennas. Use only antennas supplied by TERADEK. Any changes or modifications to the antenna may void the regulatory approvals obtained for the product.

USING THE AC POWER ADAPTOR

- All components must be dry before connecting to an external power source
- Use ONLY a UL/IEC 62368 or UL/IEC 60950-1 2nd revision approved AC/DC power adapter class LPS with electrical output ratings range of 10-28V DC, 3A, with ambient temperature range of 0°C to 40°C.
- Use of an alternative AC/DC power adapter will invalidate any approvals given to this unit and may be dangerous.

BATTERY

This device is not supplied with batteries. In case a battery is used, please adhere to the following general battery usage guidelines:

- Use batteries with the rated voltage and current characteristics as listed in the manual.
- Use IEC 62133-approved lithium batteries such as the **Anton Bauer Digital Battery (Dionic XT 150/ Dionic XT 90)**.
- Verify battery temperature is within the range specified.
- Do not use incompatible/incorrect batteries. Use of an incompatible battery may present a risk of fire, explosion, leakage, or other hazard.
- Severe impact from dropping any battery-operated device on a hard surface could cause the battery to overheat.

- The use of a battery is not allowed for the Bolt 6 Transmitter or the Bolt 6 LT Transmitter in UNII5.

RF MODULES

These devices contain the following approved radio modules:

Device	Description	IC	FCC ID
AMN41012	HD Video Transmitter	7680A-AMN41012	VQSAMN41012
AMN42012	HD Video Receiver	7680A-AMN42012	VQSAMN42012
MBN52832	BT Module	4492A-2832	HSW2832

EU AND INTERNATIONAL RF EXPOSURE STATEMENT

The product complies with internationally recognized standards covering human exposure to electromagnetic fields from radio devices. To satisfy local RF exposure regulation requirements, the transmitting product must operate with a minimum separation distance of 20 cm or more from a person's body.

FCC RF EXPOSURE STATEMENT

This equipment complies with the FCC RF radiation exposure limits set forth for an uncontrolled environment. This equipment should be installed and operated with a minimum distance of 20 centimeters between the radiator and your body. This transmitter must not be co-located or operating in conjunction with any other antenna or transmitter.

IC RADIATION EXPOSURE STATEMENT

Important Note: Radiation Exposure Statement

This equipment complies with IC radiation exposure limits set forth for an uncontrolled environment. This equipment should be installed and operated with minimum distance 20cm between the radiator and your body.

Note Importante: Déclaration d'exposition aux radiations

Cet équipement est conforme aux limites d'exposition aux rayonnements IC établies pour un environnement non contrôlé. Cet équipement doit être installé et utilisé avec un minimum de 20 cm de distance entre la source de rayonnement et votre corps.

Antenna Information

The radio transmitters **7680A-AMN41012 (HD Transmitter)**, **7680A-AMN42012 (HD Receiver)**, and **4492A-2832 (BT Module)** have been approved by Industry Canada to operate with the antenna types listed below with the maximum permissible gain indicated. Antenna types not included in this list, having a gain greater than the maximum gain indicated for that type, are strictly prohibited for use with

this device. Under Industry Canada regulations, this radio transmitter may only operate using an antenna of a type and maximum (or lesser) gain approved for the transmitter by Industry Canada. To reduce potential radio interference to other users, the antenna type and its gain should be so chosen that the equivalent isotropically radiated power (e.i.r.p.) is not more than that necessary for successful communication.

Informations sur l'antenne

Les présent émetteur radios **7680A-AMN41012 (HD Transmitter)**, **7680A-AMN42012 (HD Receiver)**, and **4492A-2832 (BT Module)** ont été approuvé par Industrie Canada pour fonctionner avec les types d'antenne énumérés ci-dessous et ayant un gain admissible maximal et l'impédance requise pour chaque type d'antenne. Les types d'antenne non inclus dans cette liste, ou dont le gain est supérieur au gain maximal indiqué, sont strictement interdits pour l'exploitation de l'émetteur. Conformément à la réglementation d'Industrie Canada, le présent émetteur radio peut fonctionner avec une antenne d'un type et d'un gain maximal (ou inférieur) approuvé pour l'émetteur par Industrie Canada. Dans le but de réduire les risques de brouillage radioélectrique à l'intention des autres utilisateurs, il faut choisir le type d'antenne et son gain de sorte que la puissance isotrope rayonnée équivalente (p.i.r.e.) ne dépasse pas l'intensité nécessaire à l'établissement d'une communication satisfaisante.

Modules IC	Antenna	Max Permissible Gain	Location	Antenna Impedance
7680A-AMN41012	Dipole	2dBi Typical at 5GHz	External	50Ω
7680A-AMN42012	Dipole	2dBi Typical at 5GHz	External	50Ω
7680A-AMN42012	Dipole	11dBi Typical at 5GHz	External	50Ω
4492A-2832	Internal Antenna		Internal	

UNINTENTIONAL RADIO INTERFERENCE

FCC COMPLIANCE STATEMENT

This equipment has been tested and found to comply with the limits for a Class A digital device, pursuant to Part 15 of the FCC rules. These limits are designed to provide reasonable protection against harmful interference in a residential installation. This equipment generates, uses, and can radiate radio frequency energy, and, if not installed and used in accordance with the instructions, may cause harmful interference to radio communications. However, there is no guarantee that interference will not occur in a particular installation. If this equipment does cause harmful interference to radio or television reception, which can be determined by turning the equipment off and on, the user is encouraged to try to correct the interference by one or more of the following measures:

- Reorient or relocate the receiving antenna.

- Increase the separation between the equipment and the receiver.
- Connect the equipment into an outlet on a circuit different from that to which the receiver is connected.
- Consult the dealer or an experienced radio or television technician for help

This equipment complies with **Part 15** of the FCC rules. Operation is subject to the following two conditions:

1. This device may not cause harmful interference, and
2. This device must accept any interference received, including interference that may cause undesired operation.

IC COMPLIANCE STATEMENT - CAN ICES-3 (A)/NMB-3 (A)

This device complies with the Innovation, Science and Economic Development Canada's licence-exempt RSS(s). Operation is subject to the following two conditions:

1. This device may not cause harmful interference, and
2. This device must accept any interference received, including interference that may cause undesired operation.

L'émetteur/récepteur exempt de licence contenu dans le présent appareil est conforme aux CNR d'Innovation, Sciences et Développement économique Canada applicables aux appareils radio exempts de licence. L'exploitation est autorisée aux deux conditions suivantes:

1. L'appareil ne doit pas produire de brouillage, et
2. L'appareil doit accepter tout brouillage radioélectrique subi, même si le brouillage est susceptible d'en compromettre le fonctionnement.

RADIO TRANSMITTER

General

- Operation of these devices in the 5.925-6.425 GHz band is prohibited on oil platforms, cars, trains, boats, and aircraft, except that operation of this device is permitted in large aircraft while flying above 10,000 feet.
- Operation of these devices in the 5.925-6.425 GHz band is prohibited for control of or communications with unmanned aircraft systems.
- Any changes or modifications not expressly approved by the party responsible for compliance could void the user's authority to operate the equipment.
- In the 5.925-6.425 GHz band, devices containing AMN42012 (a client device) must operate under the control of a device containing the AMN41012, an indoor access point. Access points may connect to other access points. Client devices are prohibited from connecting directly to another

client device. In all cases, an exception exists for transmitting brief messages to an access point when attempting to join its network after detecting a signal that confirms that an access point is operating on a particular channel.

FCC STATEMENT

Radio Transmitters (Part 15) – Class A Digital Devices

This device complies with Part 15 of the FCC Rules. Operation is subject to the following two conditions:

1. This device may not cause harmful interference, and
2. This device must accept any interference received, including interference that may cause undesired operation.
3. FCC regulations restrict the operation of these devices in the 5.925-6.425 GHz band to indoor use only.

IC STATEMENT

This device complies with RSS-247 AND RSS-248 of the Industry Canada Rules. Operation is subject to the following two conditions:

1. This device may not cause harmful interference, and
2. This device must accept any interference received, including interference that may cause undesired operation.

Ce dispositif est conforme à la norme CNR-247 et CNR-248 d'Industrie Canada applicable aux appareils radio exempts de licence. Son fonctionnement est sujet aux deux conditions suivantes:

1. Le dispositif ne doit pas produire de brouillage préjudiciable, et
2. Ce dispositif doit accepter tout brouillage reçu, y compris un brouillage susceptible de provoquer un fonctionnement indésirable.

IC STATEMENT - Operation at 5GHz Range

Caution:

1. The device for operation in the band 5150-5250 MHz is only for indoor use to reduce the potential for harmful interference to co-channel mobile satellite systems;
2. Users should also be advised that high-power radars are allocated as primary users (i.e. priority users) of the bands 5250-5350 MHz and 5650-5850 MHz and that these radars could cause interference and/or damage to LE-LAN devices.
3. The maximum antenna gain permitted for devices in the bands 5250-5350 MHz and 5470-5725 MHz shall be such that the equipment still complies with the e.i.r.p. limit;
4. The maximum antenna gain permitted for devices in the band 5725-5850 MHz shall be such that the equipment still complies with the e.i.r.p. limits specified for point-to-point and non point-to-point operation as appropriate.
5. Operation is limited to indoor use only in the band 5925-6425 MHz.

6. Operation on oil platforms, cars, trains, boats, and aircraft shall be prohibited except for on large aircraft flying above 10,000 ft.

Avertissement:

1. Les dispositifs fonctionnant dans la bande 5 150-5 250 MHz sont réservés uniquement pour une utilisation à l'intérieur afin de réduire les risques de brouillage préjudiciable compliesaux systèmes de satellites mobiles utilisant les mêmes canaux;
2. De plus, les utilisateurs devraient aussi être avisés que les utilisateurs de radars de haute puissance sont désignés utilisateurs principaux (c.-à-d., qu'ils ont la priorité) pour les bandes 5250-5350 MHz et 5650-5850 MHz et que ces radars pourraient causer du brouillage et/ou des dommages aux dispositifs LAN-EL.
3. Le gain d'antenne maximum autorisé pour les appareils fonctionnant sous les bandes de fréquences 5250-5350 MHz et 5470-5725 MHz doit être tel que l'équipement est toujours conforme à la limite PIRE;
4. Le gain d'antenne maximum autorisé pour les appareils fonctionnant sous les bandes de fréquences 5725-5850 MHz doit être tel que l'équipement est toujours conforme à la limite PIRE spécifiée pour un fonctionnement point à point et non point à point, le cas échéant.
5. Utilisation limitée à l'intérieur seulement dans la bande 5925-6425 MHz.
6. Utilisation interdite à bord de plateformes de forage pétrolier, de voitures, de trains, de bateaux et d'aéronefs, sauf à bord d'un gros aéronef volant à plus de 10 000 pieds d'altitude

EC DECLARATION OF CONFORMITY

This equipment may be operated in all EU countries with the following restrictions:

- 5.925 - 6.425GHz frequencies for indoor use only

Teradek hereby declares that this Radio Transmitter is in compliance with the essential requirements and other relevant provisions of Directives 2014/53/EU, 2011/65/EU, and 2015/863/EU. The full text of the EU DoC is located at: <https://support.cs.inc/s/article/What-is-the-EC-Declaration-of-Conformity-for-CE-mark-for-my-Teradek-product>

WASTE ELECTRICAL AND ELECTRONIC EQUIPMENT (WEEE)

English: Waste electrical and electronic equipment should not be disposed of with household waste. Please recycle where facilities exist. Check with your local authority or retailer for recycling advice.

Français: Déchets d'équipements électriques et électroniques ne doit pas être jeté avec les ordures ménagères. S'il vous plaît recycler où les installations existent. consultez auprès de votre autorité locale ou le détaillant pour obtenir des conseils de recyclage.

Deutsch: Elektro- und Elektronik-Altgeräte dürfen nicht mit dem Hausmüll entsorgt werden. Bitte recyceln, wo Anlage vorhanden sind. Beraten Sie sich bei Ihren lokale Behörde oder händler über Recycling information.

SUPPORT RESOURCES

In addition to this Reference Guide, you can find more information on Bolt 4K devices' features and operation by visiting www.teradek.com. If you are unable to find what you need online, please contact Teradek's support staff.

E-mail: support@teradek.com | Phone: (888) 941-2111 ext. 2 (available M-F 7 am-6 pm PST)

DISCLAIMER

This manual is intended for user information only. Every effort has been made to ensure that the contents within are accurate at the time of printing, and that updates are made in a timely manner. Teradek cannot be held responsible for inaccuracies, typographical errors, or out-of-date information contained within this manual.

Bolt 6 U-NII-5 (6GHz) support by region

Bolt 6 radios are calibrated and tested to support operation in the U-NII-5 (5.925–6.425GHz) frequencies. Although the product and its internal radios support these additional frequencies vs. previous Bolt products, regulatory restrictions mean that U-NII-5 operation is allowed only in the regions where it has been cleared for use. As different regions approve U-NII-5 for unlicensed operation, Teradek will release firmware updates to enable the additional frequencies. Note that we sometimes refer to U-NII-5 frequencies as “6GHz” to make it simpler to understand Bolt 4K (5GHz only) vs. Bolt 6 operation (5GHz and 6GHz).

Background

Bolt 4K and Bolt 6 operate on license free frequencies within certain U-NII (Unlicensed National Information Infrastructure) frequency bands. Bolt 4K works in U-NII-1, U-NII-2A, U-NII-2C, and U-NII-3 bands. These frequencies are now also common in commercial wi-fi equipment. Bolt 6 supports all of those, but adds support for U-NII-5 as a separate frequency range. Note that the following table represents the US (FCC) region, other regions may be more limited.

U-NII band	Frequency range	Selectable Frequencies (40MHz)	Selectable Frequencies (20MHz)	Bolt 4K Support	Bolt 6 Support*
U-NII-1	5.150–5.250	2	5	?	?
U-NII-2A (DFS)	5.250–5.350	2	4	?	?
U-NII-2B (DFS)	5.350–5.470	-	-	?	?
U-NII-2C (DFS)	5.470–5.725	6	12	?	?
U-NII-3	5.725-5.850	3	6	?	?
U-NII-4	5.850–5.925	-	-	?	?
U-NII-5	5.925–6.425	12	25	?	?
		Total selectable frequencies (40/20 MHz)		13/27	25/52

*Note that Bolt 4K LT HDMI supports the same frequencies as Bolt 6, as of firmware package 4.3.0

U-NII-5 (6GHz) support by region

Teradek products are built to comply with regulatory requirements for all markets in which they are sold. As such, we can only enable U-NII-5 support in the regions where it is approved for license-free use. Teradek will release firmware updates with additional regional support as they become available.

Region	U-NII-5 Approval	Firmware available	Expected availability
US (FCC)	Yes	Yes	Now
Europe	Yes*	Yes	Now
Canada	Yes	Yes	Now
Japan (Indoors)	Yes	Yes	Now
Japan (Outdoors)	Yes	Yes	Now
Australia/New Zealand	TBD	No	2024

*As of firmware package 4.3.4

NOTE: Additional region support TBD, will be added as regulation and certification allows

Configuration

By default, Bolt 6 operates in the 5GHz range. This allows backwards compatibility with Bolt 4K systems and in low interference environments will allow for the highest maximum range. Switching to U-NII-5 (6GHz) frequencies allows Bolt 6 to operate with minimal interference as very few other products support these frequencies. To configure Bolt 6 for 6GHz operation simply switch TX and RX units to the 6GHz band in the wireless settings menu. This can be done via the app or OLED display.

- **TX:** open menu, Wireless Settings, frequency range. Select 6GHz
- **RX:** open menu, Wireless Settings, frequency range. Select 6GHz

Associated menus for frequency selection will only show frequencies for the selected bands. Automatic frequency hopping works on either the 6GHz or 5GHz bands, but does not support scanning both. All systems must be set to 6GHz to work in the 6GHz range.

Frequencies by Region

NOTE: Pairing the TX and RX is required after a different region is selected.

Region	Channel	Freq	Power	Notes
USA	36	5120	300mW	
	37	5180	300mW	
	38	5240	300mW	
	39	5300	300mW	
	40	5360	300mW	
	41	5420	300mW	
	42	5480	300mW	
	43	5540	300mW	
	44	5600	300mW	
	45	5660	300mW	
Europe	36	5120	300mW	
	37	5180	300mW	
	38	5240	300mW	
	39	5300	300mW	
	40	5360	300mW	
	41	5420	300mW	
	42	5480	300mW	
	43	5540	300mW	
	44	5600	300mW	
	45	5660	300mW	
Japan	36	5120	300mW	
	37	5180	300mW	
	38	5240	300mW	
	39	5300	300mW	
	40	5360	300mW	
	41	5420	300mW	
	42	5480	300mW	
	43	5540	300mW	
	44	5600	300mW	
	45	5660	300mW	

Bolt 6 XT System

BOLT 6 XT SYSTEM

BOLT 6 XT TRANSMITTER

BOLT 6 XT RECEIVER

VIDEO

Video Inputs	1x 12G-SDI SMPTE 2082-1 standard/75 Ω (BNC x 1) 1x HDMI 2.0 Type-A receptacle	N/A
Video Outputs	1x Loopout 12G-SDI SMPTE 2082-1 standard/75 Ω (BNC x 1)	1x 12G-SDI SMPTE 2082-1 standard/75 Ω (BNC x 1) 1x HDMI 2.0 Type-A receptacle
SDI Ancillary Data Support	Supports transmitting timecode and start/stop flags from most camera manufacturers. More metadata for Arri and Sony cameras.	
Color Sampling	SDI: YCbCr 4:2:2, 10-bit HDMI: RGB/YCbCr; 4:4:4/4:2:2/4:2:0; 8/10-bit	SDI: YCbCr 4:2:2, 10-bit HDMI: RGB/YCbCr; 4:4:4/4:2:2/4:2:0; 8/10-bit

Delay (TX to RX)	<0.001sec (without format conversions)	
Supported Resolutions	4Kp23.98/24/25/29.97/30/50/59.94/60 1080p23.98/24/25/29.97/30/50/59.94/60 1080psf23.98/24/25/29.97/30 1080i50/59.94/60 720p50/59.94/60	
Input Cross Conversion	Yes (HDMI input to SDI loopout)	N/A
Output Video Processing	N/A	Yes (deinterlacer, frame rate converter, scaler, 3D LUTs)
Other Tools	SDI Eye Pattern Display	Spectrum Analyzer, Test Pattern Generator

VIDEO PROCESSING

Video Compression	Visually lossless	Visually lossless
Test Pattern Generator	N/A	Yes
Video Format Conversion Support	Yes	Yes
Spectrum Analyzer	N/A	Yes
Color Correction	N/A	17x17x17 3D LUT (Supports 10-bit color)

AUDIO

Audio Format	48kHz 24-bit PCM	48kHz 24-bit PCM
Audio Input	Embedded SDI/HDMI Audio Input (2 Channel)	N/A
Audio Output	N/A	Embedded SDI/HDMI Audio Output (2 Channel)

PHYSICAL ATTRIBUTES

Dimensions	5.2" x 3.6" x 1.1" (132 x 91 x 27mm)	4.4" x 5.5" x 1.1" (112 x 139 x 27mm)
Weight	12.1oz (344g)	15.2oz (430g)
Construction	Milled aluminum (chassis), regulation-compliant PCB	

INTERFACES

Configuration Interface	OSD with Menu Joystick Navigation	OSD with Menu Joystick Navigation
Switches	On/Off Switch	On/Off Switch
Desktop App	Bolt Manager app (OSX and Windows)	Bolt Manager app (OSX and Windows)
Mobile App	Bolt App (iOS and Android)	Bolt App (iOS and Android)
USB Interface Functionality	Upgrade via USB-C, 5-pin locking connector CCU	Upgrade via USB-C, 5-pin locking connector CCU
Bluetooth Compatibility	Yes	Yes

NETWORK

Wireless	DFS Frequencies: 5.270 ~ 5.670 GHz Non-DFS Frequencies: 5.190 ~ 5.230 GHz, 5.755 ~ 5.795 GHz, and 5.945 ~ 6.425GHz	DFS Frequencies: 5.270 ~ 5.670 GHz Non-DFS Frequencies: 5.190 ~ 5.230 GHz, 5.755 ~ 5.795 GHz, and 5.945 ~ 6.425GHz
Bluetooth	2.4GHz	2.4GHz
RF Channel Selection	Auto, Manual	Auto, Manual
Encryption	AES-256, RSA-1024 key exchange	AES-256, RSA-1024 key exchange
RF Power	23 dBm EIRP (max power)	21 dBm EIRP (max power)
Antennas	MAX: 4x External 2dBi antennas, 2x H-V antennas 750/1500: 4x External 2dBi antennas	MAX: 5x External 2dBi antennas, 2x H-V antennas 750/1500: 5x External 2dBi antennas

Range	MAX: Up to 3000ft (914m) line of sight (5000ft [1524m] with optional Bolt Panel Antenna) 1500: Up to 1500ft (457m) line of sight 750: Up to 750ft (229m) line of sight	
Multicast	750/1500/MAX: Can connect one transmitter to up to 6 receivers MAX (with Broadcast Mode enabled): Can connect one transmitter to unlimited receivers	
Noise Rejection	Can coexist with Wi-Fi and 5GHz cordless phones, and operate up to 6 sets in the same location	Can coexist with Wi-Fi and 5GHz cordless phones, and operate up to 6 sets in the same location
POWER		
Power Input	2-Pin locking connector 10-28 VDC	2-Pin locking connector 10-28 VDC
Battery	None, optional Sony/Canon dual battery plate	None, optional Gold or V-mount battery plate
Nominal Power Consumption	20 Watts	18 Watts
Operating Temperature	0~40 deg-C	0~40 deg-C
GENERAL		
Mounting	Multiple mounting options with M3 and 1/4-20" holes	Multiple mounting options with M3, 3/8" and 1/4-20" holes

Bolt 6 LT System

BOLT 6 LT SYSTEM

	BOLT 6 LT TRANSMITTER	BOLT 6 LT TRANSMITTER
VIDEO		
Video Inputs	1x 3G-SDI SMPTE 424M standard/75 Ω (BNC x 1), 1x HDMI 1.4b Type-A receptacle	N/A
Video Outputs	1x 3G-SDI SMPTE 424M standard/75 Ω (BNC x 1)	1x 3G-SDI SMPTE 424M standard/75 Ω (BNC x 1), 1x HDMI 1.4b Type-A receptacle
SDI Ancillary Data Support	Supports transmitting metadata, timecode, and start/stop flags from certain camera manufacturers.	
Color Sampling	SDI: YCbCr 4:2:2 10-Bit/HDMI: RGB 4:4:4, 8-bit	SDI: YCbCr 4:2:2 10-Bit/HDMI: RGB 4:4:4, 8-bit
Delay (TX to RX)	<0.001sec (without format conversions)	
Supported Resolutions	4Kp23.98/24/25/29.97/30 (HDMI only) 1080p23.98/24/25/29.97/30/50/59.94/60 1080psf23.98/24/25/29.97/30 1080i50/59.94/60 720p50/59.94/60	
Input Cross Conversion	Yes, HDMI to SDI (4Kp30 HDMI input is scaled and looped out as 1080p30 on SDI loopout)	N/A
Output Video Scaling	N/A	No (4Kp30 signals are output on HDMI, but scaled to 1080p30 and output over SDI. 4Kp60 signals received from Bolt 4K XT devices are scaled to 1080p60 and output over both HDMI and SDI outputs)
VIDEO PROCESSING		

Video Compression	Visually lossless	N/A
Test Pattern Generator	N/A	Yes
Spectrum Analyzer	N/A	Yes
AUDIO		
Audio Compression	48kHz 24-bit PCM	48kHz 24-bit PCM
Audio Input	Embedded SDI/HDMI Audio Input (2 channel)	N/A
Audio Output	N/A	Embedded SDI/HDMI Audio Input (2 channel)
PHYSICAL ATTRIBUTES		
Dimensions	2.4" x 4.1" x 1.3" (60 x 103 x 33mm)	4.8" x 3.7" x 1" (122 x 94 x 27mm)
Weight	7.3oz (206g)	10.3oz (292g)
Construction	Milled aluminum (chassis), regulation-compliant PCB	
INTERFACES		
Configuration Interface	OSD with Menu Joystick Navigation	OSD with Menu Joystick Navigation
Switches	On/Off Switch	On/Off Switch
Desktop App	Bolt Manager app (OSX and Windows)	Bolt Manager app (OSX and Windows)
Mobile App	Bolt App (iOS and Android)	Bolt App (iOS and Android)
USB Interface	Upgrade via Micro-USB	Upgrade via Micro-USB
Bluetooth Compatibility	Yes	Yes
NETWORK		

Wireless	DFS Frequencies: 5.270 ~ 5.670 GHz Non-DFS Frequencies: 5.190 ~ 5.230 GHz, 5.755 ~ 5.795 GHz, and 5.945 ~ 6.425GHz	DFS Frequencies: 5.270 ~ 5.670 GHz Non-DFS Frequencies: 5.190 ~ 5.230 GHz, 5.755 ~ 5.795 GHz, and 5.945 ~ 6.425GHz
Bluetooth	2.4GHz	2.4GHz
RF Channel Selection	Auto, Manual	Auto, Manual
Encryption	AES-256, RSA-1024 key exchange	AES-256, RSA-1024 key exchange
RF Power	23 dBm EIRP (max power)	21 dBm EIRP (max power)
Antennas	MAX: 2x External 2dBi antennas, 1x H-V antennas 750/1500: 4x External 2dBi antennas	MAX: 5x External 2dBi antennas, 2x H-V antennas 750/1500: 5x External 2dBi antennas
Range	MAX: Up to 3000ft (914m) line of sight (5000ft [1524m] with optional Panel Antenna) 1500: Up to 1500ft (457m) line of sight 750: Up to 750ft (229m) line of sight	MAX: Up to 3000ft (914m) line of sight (5000ft [1524m] with optional Panel Antenna) 1500: Up to 1500ft (457m) line of sight 750: Up to 750ft (229m) line of sight
Multicast	750/1500: Can connect one transmitter to up to 6 receivers MAX (with Broadcast Mode enabled): Can connect one transmitter to unlimited receivers	
Noise Rejection	Can coexist with Wi-Fi and 5GHz cordless phones, and operate up to 6 sets in the same location	Can coexist with Wi-Fi and 5GHz cordless phones, and operate up to 6 sets in the same location
Interoperability	Can transmit wireless video to all ranges of Bolt 4K XT and Bolt 4K LT receivers (limited by shortest range device)	Can receive wireless video from all ranges of Bolt 4K XT and Bolt 4K LT transmitters (limited by shortest range device)
POWER		
Power Input	2-Pin locking connector 6-28V DC	2-Pin locking connector 6-28V DC
Battery	None, optional Sony/Canon dual battery plate	None, optional Gold or V mount battery plate

Nominal Power Consumption	9 Watts	11 Watts
---------------------------	---------	----------

Operating Temperature	32~104°F (0~40°C)	32~104°F (0~40°C)
-----------------------	-------------------	-------------------

GENERAL

Mounting	Multiple mounting options with M3 and 1/4-20" holes	Multiple mounting options with 3/8"x16 and 1/4-20" holes
----------	---	--

Bolt 6 LT-HDMI System

	BOLT 4K LT-HDMI TRANSMITTER	BOLT 4K LT-HDMI RECEIVER
VIDEO		
Video Inputs	1x HDMI 1.4b Type-A receptacle	N/A
Video Outputs	1x HDMI 1.4b Type-A receptacle	1x HDMI 1.4b Type-A receptacle
SDI Ancillary Data Support	N/A	N/A
Color Sampling	YCbCr 4:2:2 10-bit RGB 4:4:4, 8-bit	YCbCr 4:2:2 10-bit RGB 4:4:4, 8-bit
Delay (TX to RX)	<0.001sec (without format conversions)	<0.001sec (without format conversions)
Supported Resolutions	4Kp23.98/24/25/29.97/30 1080p23.98/24/25/29.97/30/50/59.94/60 1080i50/59.94/60 720p50/59.94/60	4Kp23.98/24/25/29.97/30 1080p23.98/24/25/29.97/30/50/59.94/60 1080i50/59.94/60 720p50/59.94/60
Input Cross Conversion	N/A	N/A
Output Video Scaling	N/A	N/A
VIDEO PROCESSING		
Video Compression	Visually lossless	Visually lossless
Test Pattern Generator	N/A	N/A
Spectrum Analyzer	N/A	N/A
Color Correction	N/A	N/A
AUDIO		
Audio	48kHz 24-bit PCM	48kHz 24-bit PCM

Compression

Audio Input	Embedded HDMI Audio Input (2 channel)	N/A
Audio Output	N/A	Embedded HDMI Audio Input (2 channel)

PHYSICAL ATTRIBUTES

Dimensions	2.4" x 4.1" x 1.3" (60 x 103 x 33mm)	4.8" x 3.7" x 1" (122 x 94 x 25mm)
Weight	7.3oz (206g)	10.3oz (292g)
Construction	Milled aluminum (chassis) and regulation-compliant PCB	

INTERFACES

Configuration Interface	OLED Screen with Menu Joystick Navigation	OLED Screen with Menu Joystick Navigation
Switches	On/Off Switch	On/Off Switch
Desktop App	Bolt Manager app (OSX and Windows)	Bolt Manager app (OSX and Windows)
Mobile App	Bolt App (iOS and Android)	Bolt App (iOS and Android)
USB Interface	Upgrade via Micro-USB 5-pin Locking Connector CCU	Upgrade via Micro-USB 5-pin Locking Connector CCU
Bluetooth Compatibility	Yes	Yes

NETWORK

Wireless	DFS Frequencies: 5.270 ~ 5.670 GHz Non-DFS Frequencies: 5.190 ~ 5.230 GHz, 5.755 ~ 5.795 GHz, and 5.945 ~ 6.425GHz	DFS Frequencies: 5.270 ~ 5.670 GHz Non-DFS Frequencies: 5.190 ~ 5.230 GHz, 5.755 ~ 5.795 GHz, and 5.945 ~ 6.425GHz
Bluetooth	2.4GHz	2.4GHz
RF Channel Selection	Auto, Manual	Auto, Manual
Encryption	AES-256, RSA-1024 key exchange	AES-256, RSA-1024 key exchange

RF Power	19 dbm EIRP (2x external 2dBi antennas; <80mW transmit power)	17 dbm EIRP (1x external 2dBi antenna; <51mW transmit power)
Antennas	2x External 2dBi antennas	5x External 2dBi antennas
Range	Up to 750ft (229m) line of sight	Up to 750ft (229m) line of sight
Multicast	TX transmits video to up to 6 receivers simultaneously	Pair up to 4 transmitters per receiver
Noise Rejection	Can coexist with Wi-Fi and 5GHz cordless phones, and operate up to 6 sets in the same location	Can coexist with Wi-Fi and 5GHz cordless phones, and operate up to 6 sets in the same location
Interoperability	Can transmit wireless video to all ranges of Bolt 4K XT and Bolt 4K LT receivers (limited by shortest range device)	Can receive wireless video to all ranges of Bolt 4K XT and Bolt 4K LT transmitters (limited by shortest range device)

POWER

Power Input	2-Pin locking connector 6-28V DC	2-Pin locking connector 6-28V DC
Battery	None, optional Sony/Canon dual battery plate	None, optional Gold or V mount battery plate
Nominal Power Consumption	9 Watts	11 Watts
Operating Temperature	32~104°F (0~40°C)	32~104°F (0~40°C)

GENERAL

Mounting	Multiple mounting options with M3 and 1/4-20" holes	Multiple mounting options with 3/8"x16 and 1/4-20" holes
----------	---	--

Bolt 6 Monitor Module

BOLT 6 MONITOR MODULE (TX/RX)

VIDEO	
Video Input/Output	1x HDMI 1.4b Type-A receptacle, feeds into Smart 7 HDMI input v
Color Sampling	SDI: YCbCr 4:2:2 10-bit/HDMI: RGB 4:4:4, 8-bit
Delay (TX to RX)	<0.001sec (without format conversions)
SDI Ancillary Data Support	Supports reading metadata, timecode, and start/stop flags from
Supported Resolutions	4Kp23.98/24/25/29.97/30 1080p23.98/24/25/29.97/30/50/59.94/60 1080psf23.98/24/25/29.97/30 1080i50/59.94/60 720p50/59.94/60
VIDEO PROCESSING	
Video Compression	Visually lossless
Color Correction	None
Test Pattern Generator	N/A
Spectrum Analyzer	N/A
AUDIO	
Audio Compression	48kHz 24-bit PCM
Audio Input/Output	Embedded HDMI Audio Input (2 Channel)
PHYSICAL ATTRIBUTES	
Dimensions	5" x 4.6" x 1" (127 x 117 x 19mm)
Weight	10.1oz (268g)
Construction	Milled aluminum (chassis), regulation-compliant PCB
INTERFACES	

Configuration Interface	SmallHD Monitor UI
Switches	N/A
Desktop App	N/A
Mobile App	Bolt App (iOS and Android)
USB Interface Functionality	SmallHD Monitor UI, 2x 5-pin Locking Connector CCU (Host)
Bluetooth Compatibility	Via SmallHD Monitor
NETWORK	
Wireless	DFS Frequencies: 5.270 ~ 5.670 GHz Non-DFS Frequencies: 5.190 ~ 5.230 GHz, 5.755 ~ 5.795 GHz, and 5.945 ~ 6.425GHz
RF Channel Selection	Auto, Manual
Encryption	AES-256, RSA-1024 key exchange
RF Power	TX Module: 23 dbm EIRP RX Module: 21 dbm EIRP
Antennas	RX Module: 5x External 2dBi antennas (included) TX Module: 2x External 2dBi antennas (included)
Range	1500: Up to 1500ft (457m) line of sight 750: Up to 750ft (229m) line of sight
Multicast	Can connect one transmitter to up to 6 receivers
Noise Rejection	Can coexist with WiFi and 5GHz cordless phones, Can operate up to 6 sets in same location
Interoperability	TX Module: Can transmit wireless video to all ranges of Bolt 4K X (limited by shortest range device) RX Module: Can receive wireless video from all ranges of Bolt 4K X (limited by shortest range device)
POWER	
Power Input	2-Pin locking connector 6-18V DC
Battery	TX Module: None, optional Sony/Canon dual battery plate

RX Module: None, optional Gold or V mount battery plate

Nominal Power Consumption 6 Watts

Operating Temperature 32~104°F (0~40°C)

GENERAL

Mounting Mounts in between SmallHD Smart 7 monitor and battery plate.

Bolt Panel Antenna v.4

BOLT PANEL ANTENNA V.4

WIRELESS

Frequency Range	4.9 - 7.5 GHz
Gain	14 and 16dBi
Polarization	2x Horizontal, 5x Vertical for polarization
Beam-width deg horizontal	75°
Beam-width deg vertical	35°
Impedance	50 ohm

PHYSICAL ATTRIBUTES

Dimensions	13.78 x 13.78 x 1.25 in (35 x 35 x 3.18 cm)
Weight	39oz [1111.3g]
Construction	UV-protected plastic with aluminum alloy (construction-grade)
Connectors	RP-SMA
Operating Temperature	-40~176°F (-40°C to 80°C)