



Focus Gear & Clamp for Canon 100mm IS USM Lens

Product Number - 5509.71

Included in the Box

- Lens Ring - Canon 100mm IS USM # 0098.31
- Port Gear Sleeve # 0073.1
- Clamp # 9059.9

Installation and Use

Attach the Sleeve, Adapter and Clamp

1. Rotate Gear Sleeve Retainer counterclockwise and remove using Gear Sleeve Retainer Tool.
2. Place Port Gear Sleeve into the housing Port Mount opening.
3. Tighten Gear Sleeve Retainer into Port Mount using Gear Sleeve Retainer Tool. Tighten clockwise so Retainer is snug - **Diagram A**. DO NOT overtighten.
4. Slide Sleeve Adapter Small Slots into Gear Sleeve Posts - **Diagram B**.
5. Gently expand and place Clamp over front of lens. Push Clamp down to lens position shown - **Diagram C**.
6. Line up the two red dots on the camera face and bayonet end of the lens.
7. Rotate lens focus ring until Clamp Tabs line up with Sleeve Adapter Large Slots.
8. Lower lens and bayonet onto the camera body by rotating lens clockwise - **Diagram C**.
9. Push clamp down on the lens until the Clamp Tabs slide fully into the Sleeve Adapter Large Slots.
10. Rotate housing knob to check focus function.
11. Install Lens Port.

Diagram A

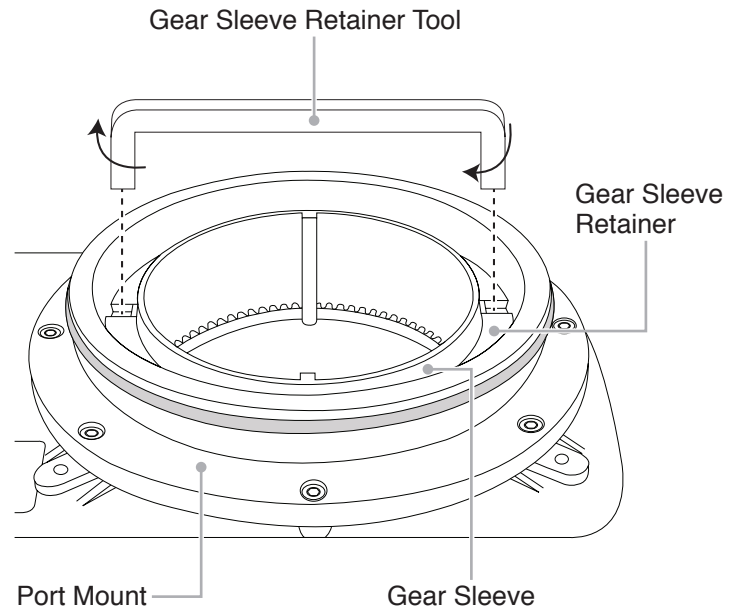
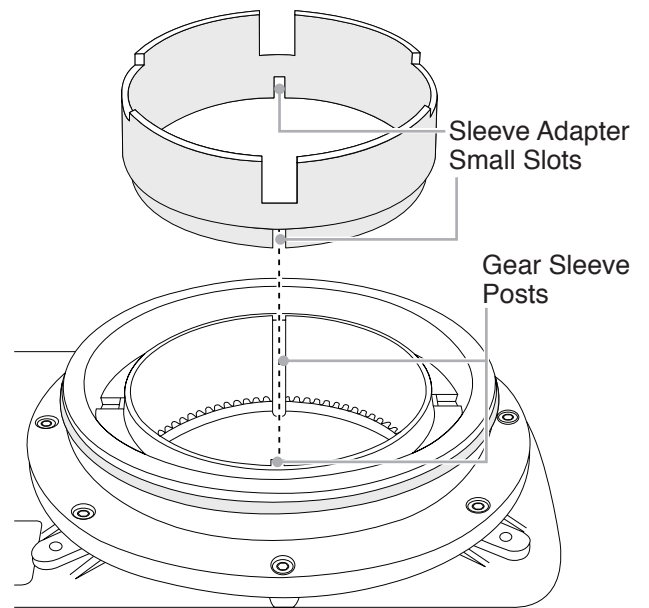

Diagram B



Limited Warranty

This Ikelite product is warranted against any manufacturing defects for a period of one (1) year from the original date of purchase. To obtain warranty service, the product must be returned to Ikelite postage paid. Ikelite will, at its sole discretion, repair or replace such products, and will return to customer postage paid. All other claims of any nature are not covered. Except as mentioned above, no other warranty expressed or implied applies to this Ikelite product.

Diagram C

