

PowerShot SX740 HS Camera User Guide

ENGLISH

- Make sure you read this guide, including the “Safety Instructions” (📖 12) section, before using the camera.
- Reading this guide will help you learn to use the camera properly.
- Store this guide safely so that you can use it in the future.

- Click the buttons in the lower right to access other pages.

 : Next page

 : Previous page

 : Page before you clicked a link

- To jump to the beginning of a chapter, click the chapter title at right.

Before Use

Basic Guide

Advanced Guide

Camera Basics

Auto Mode /
Hybrid Auto Mode

Other Shooting Modes

P Mode

Tv, Av, and M Mode

Playback

Wireless Features

Setting Menu

Accessories

Appendix

Index

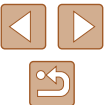

Before Use

Initial Information

Package Contents

Before use, make sure the following items are included in the package. If anything is missing, contact your camera retailer.

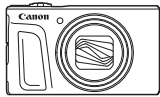

Camera



Battery Pack*



Battery Charger



Wrist Strap

* Do not peel off the adhesive covering from a battery pack.

- Printed matter is also included.
- A memory card is not included (📖2).

Compatible Memory Cards

The following memory cards (sold separately) can be used, regardless of capacity.

- SD memory cards*¹
- SDHC memory cards*^{1*2}
- SDXC memory cards*^{1*2}



*1 Cards conforming to SD standards. However, not all memory cards have been verified to work with the camera.

*2 UHS-I memory cards are also supported.

Before Use

Basic Guide

Advanced Guide

Camera Basics

Auto Mode /
Hybrid Auto Mode

Other Shooting Modes

P Mode

Tv, Av, and M Mode

Playback

Wireless Features

Setting Menu

Accessories

Appendix

Index

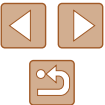

Preliminary Notes and Legal Information

- Take and review some test shots initially to make sure the images were recorded correctly. Please note that Canon Inc., its subsidiaries and affiliates, and its distributors are not liable for any consequential damages arising from any malfunction of a camera or accessory, including memory cards, that result in the failure of an image to be recorded or to be recorded in a way that is machine readable.
- The user's unauthorized photographing or recording (video and/or sound) of people or copyrighted materials may invade the privacy of such people and/or may violate others' legal rights, including copyright and other intellectual property rights. Note that restrictions may apply even when such photographing or recording is intended solely for personal use.
- The camera warranty is valid only in the area of purchase. In case of camera problems while abroad, return to the area of purchase before contacting a Customer Support Help Desk.
- Although the screen is produced under extremely high-precision manufacturing conditions and more than 99.99% of the pixels meet design specifications, in rare cases some pixels may be defective or may appear as red or black dots. This does not indicate camera damage or affect recorded images.
- When the camera is used over an extended period, it may become warm. This does not indicate damage.

Conventions in This Guide

- In this guide, icons are used to represent the corresponding camera buttons and dials on which they appear or which they resemble.
- The following camera buttons and controls are represented by icons. Numbers in parentheses indicate the numbers of corresponding controls in “Part Names” (📖4).
 - ▲ Up button (12) on back
 - ◀ Left button (8) on back
 - ▶ Right button (13) on back
 - ▼ Down button (15) on back
 - 🌀 Control dial (7) on back
- Shooting modes and on-screen icons and text are indicated in brackets.
- ⓘ: Important information you should know
- 📌: Notes and tips for expert camera use
- 📖xx: Pages with related information (in this example, “xx” represents a page number)
- Instructions in this guide apply to the camera under default settings.
- For convenience, all supported memory cards are simply referred to as the “memory card”.
- The symbols “▶ Still Images” and “▶ Movies” below titles indicate how the function is used—whether for still images or movies.

Before Use

Basic Guide

Advanced Guide

Camera Basics

Auto Mode /
Hybrid Auto Mode

Other Shooting Modes

P Mode

Tv, Av, and M Mode

Playback

Wireless Features

Setting Menu

Accessories

Appendix

Index



Part Names

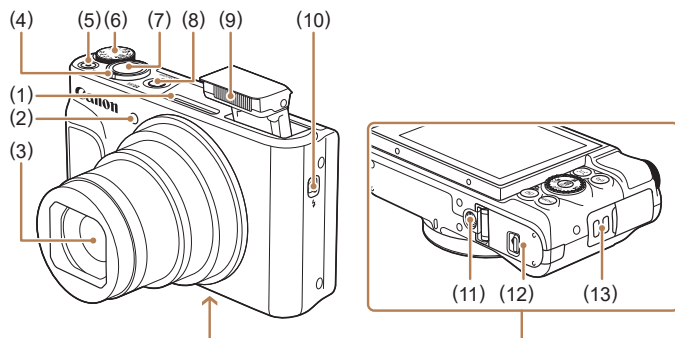

- | | |
|---|--------------------------------|
| (1) Microphone | (7) Shutter button |
| (2) Lamp | (8) Power button |
| (3) Lens | (9) Flash |
| (4) Zoom lever
Shooting: [T] (telephoto) / [W] (wide angle)
Playback: [Q] (magnify) / [I] (index) | (10) [Flash pop up] switch |
| (5) Movie button | (11) Tripod socket |
| (6) Mode dial | (12) Memory card/battery cover |
| | (13) Strap mount |

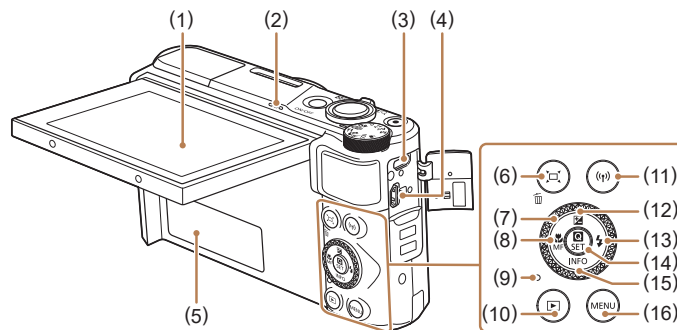

- | | |
|--|---|
| (1) Screen | (9) Indicator |
| (2) Speaker | (10) [Play] (Playback) button |
| (3) DIGITAL terminal | (11) [Wi-Fi] (Wi-Fi) button |
| (4) HDMI™ terminal | (12) [Exposure compensation] / [Up] (Exposure compensation) / Up button |
| (5) Serial number (Body number) | (13) [Flash] / [Right] (Flash) / Right button |
| (6) [Framing Assist - Seek] / [Single-image erase] (Framing Assist - Seek) / Single-image erase button | (14) [Quick Control menu/Set] (Quick Control menu/Set) button |
| (7) Control dial | (15) [INFO] (Information) / [Down] (Information) / Down button |
| (8) [Macro] / [MF] (Manual focus) / [Left] (Macro) / MF (Manual focus) / Left button | (16) MENU button |



- You can turn the control dial to perform most of the operations possible with the [Up]/[Down]/[Left]/[Right] buttons, such as choosing items and switching images.

Before Use

Basic Guide

Advanced Guide

Camera Basics

Auto Mode / Hybrid Auto Mode

Other Shooting Modes

P Mode

Tv, Av, and M Mode

Playback

Wireless Features

Setting Menu

Accessories

Appendix

Index

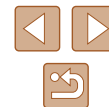

Table of Contents

Before Use

Initial Information	2
Package Contents	2
Compatible Memory Cards	2
Preliminary Notes and Legal Information	3
Conventions in This Guide	3
Part Names	4
Common Camera Operations	10
Safety Instructions	12

Basic Guide

Basic Operations	14
Initial Preparations	14
Attaching the Strap	14
Holding the Camera	14
Charging the Battery Pack	15
Inserting the Battery Pack and Your Memory Card	15
Removing the Battery Pack and Memory Card	16
Setting the Date, Time, and Time Zone	16
Display Language	17
Trying the Camera Out	18
Shooting	18
Viewing	19
Erasing Images	19

Advanced Guide

Camera Basics	20
On/Off	20
Shutter Button	21
Shooting Modes	21
Shooting Display Options	22
Adjusting the Screen Angle	22
Quick Control Screen	23
Menu Screen	23
On-Screen Keyboard	24
Indicator Display	25
Frames on the Shooting Screen	25
Auto Mode / Hybrid Auto Mode	26
Shooting with Camera-Determined Settings	26
Shooting (Smart Auto)	26
Shooting in Hybrid Auto Mode	28
Digest Movie Playback	29
Still Images	29
Movies	29
Scene Icons	29
Image Stabilization Icons	30
Common, Convenient Features	30
Zooming In Closer on Subjects (Digital Zoom)	30
Easily Reacquiring Subjects after Manual Zooming (Framing Assist – Seek)	31
Auto Zooming in Response to Subject Movement (Auto Zoom)	31
Adjusting the Constant Face Display Size	32
Adding a Date Stamp	33
Using the Self-Timer	33

Before Use
Basic Guide
Advanced Guide
Camera Basics
Auto Mode / Hybrid Auto Mode
Other Shooting Modes
P Mode
Tv, Av, and M Mode
Playback
Wireless Features
Setting Menu
Accessories
Appendix
Index

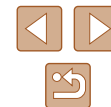

Continuous Shooting	34
Image Customization Features	34
Changing the Aspect Ratio	34
Changing Image Quality	35
Guidelines for Choosing Recording Pixel Setting Based on Paper Size (for 4:3 Images)	35
Helpful Shooting Features.....	35
Displaying a Grid	35
Deactivating Auto Level.....	36
Changing the IS Mode Settings.....	36
Deactivating Image Stabilization	36
Recording Movies with Subjects at the Same Size Shown before Shooting	37
Customizing Camera Operation	37
Preventing the AF-Assist Beam from Firing.....	37
Preventing the Red-Eye Reduction Lamp from Lighting Up.....	38
Changing the Image Display Period after Shots.....	38
Other Shooting Modes.....	39
Enhancing Colors in Shots of Food (Food)	39
Shooting Yourself under Optimal Settings (Self Portrait).....	40
Moving Subjects (Sports)	41
Specific Scenes.....	41
Applying Special Effects.....	42
Shooting with a Skin Smoothing Effect (Smooth Skin).....	43
Shooting in Monochrome (Grainy B/W).....	43
Shooting with a Soft Focus Effect.....	44
Shooting with a Fish-Eye Lens Effect (Fish-Eye Effect).....	44
Shots Resembling Oil Paintings (Art Bold Effect).....	45
Shots Resembling Watercolors (Water Painting Effect)	45
Shooting with a Toy Camera Effect (Toy Camera Effect).....	46
Shots Resembling Miniature Models (Miniature Effect).....	46

Recording Various Movies.....	47
Changing Movie Recording Size	47
Adjusting Image Brightness (Exposure Compensation).....	47
Disabling Auto Slow Shutter	48
Correcting Severe Camera Shake.....	48
Sound Settings	48
Deactivating the Wind Filter	48
Using the Attenuator	48
Recording Time-Lapse Movies	49
Miniature Model Effect in Movies (Miniature Effect Movie).....	49
Estimated Playback Time (for One-Minute Clips).....	49
Recording Video Snapshots	50
P Mode	51
Shooting in Program AE (P Mode)	51
Image Brightness (Exposure).....	52
Adjusting Image Brightness (Exposure Compensation).....	52
Locking Image Brightness / Exposure (AE Lock)	52
Changing the Metering Method	52
Changing the ISO Speed.....	53
Auto Correction of Brightness and Contrast (Auto Lighting Optimizer).....	53
Image Colors	54
Capturing Natural Colors (White Balance)	54
Custom White Balance.....	54
Manually Correcting White Balance	55
Customizing Colors (Style Settings)	55
Shooting Range and Focusing	56
Shooting Close-Ups (Macro)	56
Shooting in Manual Focus Mode	56
Easily Identifying the Focus Area (MF Peaking).....	57
Digital Tele-Converter	57
Choosing the AF Method	57

Before Use
Basic Guide
Advanced Guide
Camera Basics
Auto Mode / Hybrid Auto Mode
Other Shooting Modes
P Mode
Tv, Av, and M Mode
Playback
Wireless Features
Setting Menu
Accessories
Appendix
Index

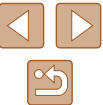

+Tracking.....	58
Choosing Subjects to Focus On (Tracking AF)	58
Center.....	59
Shooting with Servo AF	59
Changing the Focus Setting	60
Shooting with AF Lock	60
Flash.....	61
Changing the Flash Mode	61
Auto flash	61
Flash on.....	61
Slow Synchro	61
Flash off.....	61
Adjusting the Flash Exposure Compensation.....	62
Shooting with FE Lock.....	62
Other Settings	63
Changing the IS Mode Settings.....	63
Tv, Av, and M Mode	64
Specific Shutter Speeds (Tv Mode).....	64
Specific Aperture Values (Av Mode).....	65
Specific Shutter Speeds and Aperture Values (M Mode)	65
Adjusting the Flash Output	66
Playback.....	67
Viewing.....	67
Switching Display Modes.....	68
Overexposure Warning (for Image Highlights)	69
Histogram	69
GPS Information Display	69
Record of Sent Images.....	69
Viewing Short Movies Created When Shooting Still Images (Digest Movies).....	69

Browsing and Filtering Images	70
Navigating through Images in an Index	70
Finding Images Matching Specified Conditions.....	70
Image Viewing Options	71
Magnifying Images	71
Viewing Slideshows.....	72
Protecting Images	72
Protecting Multiple Images	72
Choosing a Selection Method	72
Choosing Images Individually	73
Selecting a Range	73
Specifying All Images at Once.....	74
Erasing Images	74
Erasing Multiple Images at Once.....	74
Choosing a Selection Method	74
Choosing Images Individually	75
Selecting a Range	75
Specifying All Images at Once.....	76
Rotating Images	76
Rating Images	77
Editing Still Images.....	77
Resizing Images	77
Cropping.....	78
Correcting Red-Eye.....	79
Editing Movies	79
Removing the Beginning/End of Movies.....	79
Extracting Frames of 4K Movies as Stills	80
Reducing File Sizes.....	80
Editing Digest Movies	81
Combining Video Snapshots	82

Before Use
Basic Guide
Advanced Guide
Camera Basics
Auto Mode / Hybrid Auto Mode
Other Shooting Modes
P Mode
Tv, Av, and M Mode
Playback
Wireless Features
Setting Menu
Accessories
Appendix
Index



Wireless Features	83
Available Wireless Features.....	83
Preparing to Use Wireless Features	84
Preparing the Camera	84
Preparing Smartphones.....	85
Pairing with Smartphones via Bluetooth.....	85
[Bluetooth function] Screen	86
Bluetooth function.....	86
Pairing	86
Check/clear connection info	86
Bluetooth address	86
Controlling the Camera from a Smartphone.....	86
Geotagging Images as You Shoot	87
Checking Location Information.....	87
Connecting to Smartphones via Wi-Fi.....	88
Connecting to Bluetooth Connected Smartphones via Wi-Fi	88
Connecting to Smartphones via Wi-Fi with the Wi-Fi Button.....	88
Establishing a Connection via an Access Point.....	89
Controlling the Camera from a Smartphone.....	89
Images on camera.....	89
Remote live view shooting.....	89
Sending Images to a Smartphone	90
Sending Images to a Smartphone from the Camera Menu...90	
Sending Images to a Smartphone During Playback.....90	
Sending Images to a Smartphone Automatically	
as You Shoot	90
Specifying Viewable Images.....	90
Ending Wi-Fi Connections	91
Sending Images to a Computer Automatically	91
Connecting to Printers via Wi-Fi.....	93
Establishing a Connection via an Access Point.....	94

Uploading Images to Web Services	94
Registering Web Services	94
Registering CANON iIMAGE GATEWAY.....	95
Registering Other Web Services	96
Uploading Images to Web Services	97
Reconnecting via Wi-Fi	97
Editing or Erasing Wireless Settings	98
Changing or Deleting Connection Settings.....	98
Restoring Default Wireless Settings	99
Clearing Information of Devices Paired via Bluetooth	99

Setting Menu..... 100

Adjusting Basic Camera Functions	100
Muting Camera Sounds.....	100
Adjusting the Volume.....	100
Lens Retraction Timing.....	101
Using Eco Mode	101
Power-Saving Adjustment	101
Screen Brightness	101
Hiding the Start-Up Screen.....	102
Formatting Memory Cards.....	102
Low-Level Formatting	102
Selecting and Creating Folders	103
File Numbering	103
Deactivating Auto Rotation	104
Metric / Non-Metric Display	104
Checking Certification Logos.....	104
Display Language.....	104
Changing the HDMI Output Resolution	105
Adjusting Other Settings.....	105
Restoring Default Camera Settings	105
Restoring Camera Defaults	105
Restoring Default Wireless Settings.....	105

Before Use
Basic Guide
Advanced Guide
Camera Basics
Auto Mode / Hybrid Auto Mode
Other Shooting Modes
P Mode
Tv, Av, and M Mode
Playback
Wireless Features
Setting Menu
Accessories
Appendix
Index

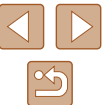

Hiding Feature Guidance.....	105
Accessories.....	106
System Map	106
Optional Accessories.....	107
Power Supplies.....	107
Other Accessories	108
Printers	108
Using Optional Accessories.....	108
Playback on a TV	108
Inserting and Charging the Battery Pack.....	109
Using a Computer to Charge the Battery	111
Using the Software.....	111
Saving Images to a Computer.....	112
Printing Images	112
Easy Print	112
Configuring Print Settings.....	113
Adding Images to the Print Orders (DPOF).....	113
Configuring Print Settings.....	113
Specifying Images to Print.....	114
Printing Images Added to the Print Order (DPOF)	114
Adding Images to a Photobook	115
Adding Images Individually.....	115
Adding Multiple Images at Once	115
Appendix.....	116
Troubleshooting.....	116
Errors and Warnings	118
On-Screen Information.....	119
Shooting (Detailed Information Display).....	119
Battery Level	119
Playback (Detailed Information Display).....	120

Handling Precautions	121
Specifications	121
Image Sensor.....	121
Lens.....	121
Shutter.....	122
Aperture.....	122
Flash Control	122
Screen	122
Shooting	122
Recording.....	123
Power	123
Interface	123
Operating Environment	123
Dimensions (CIPA compliant).....	123
Weight (CIPA compliant).....	123
Battery Pack NB-13L.....	124
Battery Charger CB-2LH/CB-2LHE	124
Compact Power Adapter CA-DC30/CA-DC30E	124
Index.....	125
Precautions for Wireless Features	127
Third-Party Software	128
Personal Information and Security Precautions	129
Trademarks and Licensing	129
Disclaimer.....	130

Before Use
Basic Guide
Advanced Guide
Camera Basics
Auto Mode / Hybrid Auto Mode
Other Shooting Modes
P Mode
Tv, Av, and M Mode
Playback
Wireless Features
Setting Menu
Accessories
Appendix
Index

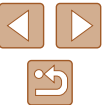

Common Camera Operations

Shoot

- Use camera-determined settings (Auto Mode, Hybrid Auto Mode)
 - 26, 28
- Enhance colors in shots of food (Food)
 - 39
- Shoot yourself under optimal settings (Self Portrait)
 - 40

Shooting people well



Portraits
(41)

Matching specific scenes



Sports
(41)



Night Scenes
(41)



Fireworks
(41)

Applying special effects



Smooth Skin
(43)



Fish-Eye Effect
(44)



Like Watercolor
Paintings
(45)



Like Oil Paintings
(45)



Miniature Effect
(46)



Toy Camera Effect
(46)



Soft Focus
(44)



Monochrome
(43)

- Focus on faces
 - 26, 41, 58
- Without using the flash (Flash Off)
 - 61
- Include yourself in the shot (Self-Timer)
 - 33
- Add a date stamp
 - 33
- Movie clips and photos together (Movie Digest)
 - 28

Before Use

Basic Guide

Advanced Guide

Camera Basics

Auto Mode /
Hybrid Auto Mode

Other Shooting Modes

P Mode

Tv, Av, and M Mode

Playback

Wireless Features

Setting Menu







Accessories

Appendix

Index



View

- View images
 -  67
- Automatic playback (Slide Show)
 -  72
- On a TV
 -  108
- On a computer
 -  112
- Browse through images quickly
 -  70
- Erase images
 -  74

Record/View Movies

- Record movies
 -  26,  47
- View movies
 -  67





Print

- Print pictures
 -  112

Save

- Save images to a computer
 -  112

Using Wi-Fi Features

- Send images to a smartphone
 -  85,  88
- Share images online
 -  94
- Send images to a computer
 -  91

Before Use

Basic Guide

Advanced Guide

Camera Basics

Auto Mode / Hybrid Auto Mode

Other Shooting Modes

P Mode

Tv, Av, and M Mode

Playback

Wireless Features

Setting Menu

Accessories

Appendix

Index

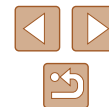

Safety Instructions

- Be sure to read these instructions in order to operate the product safely.
- Follow these instructions to prevent injury or harm to the operator of the product or others.



WARNING

Denotes the risk of serious injury or death.

- Keep the product out of the reach of young children. A strap wrapped around a person's neck may result in strangulation.
- Use only power sources specified in this instruction manual for use with the product.
- Do not disassemble or modify the product.
- Do not expose the product to strong shocks or vibration.
- Do not touch any exposed internal parts.
- Stop using the product in any case of unusual circumstances such as the presence of smoke or a strange smell.
- Do not use organic solvents such as alcohol, benzene or paint thinner to clean the product.
- Do not get the product wet. Do not insert foreign objects or liquids into the product.
- Do not insert foreign objects or liquids into the product.
- Do not use the product where flammable gases may be present. This may cause electric shock, explosion or fire.
- For products featuring a viewfinder, do not look through the viewfinder at strong light sources such as the sun on a bright day or lasers and other strong artificial light sources. This may harm your vision.

- Observe the following instructions when using commercially available batteries or provided battery packs.
 - Use batteries/battery packs only with their specified product.
 - Do not heat batteries/battery packs or expose them to fire.
 - Do not charge batteries/battery packs using non-authorized battery chargers.
 - Do not expose the terminals to dirt or let them come into contact with metallic pins or other metal objects.
 - Do not use leaking batteries/battery packs.
 - When disposing of batteries/battery packs, insulate the terminals with tape or other means.

This may cause electric shock, explosion or fire. If a battery/battery pack leaks and the material contacts your skin or clothing, flush the exposed area thoroughly with running water. In case of eye contact, flush thoroughly with copious amounts of clean running water and seek immediate medical assistance.

- Observe the following instructions when using a battery charger or AC adapter.
 - Periodically remove any dust buildup from the power plug and power outlet using a dry cloth.
 - Do not plug in or unplug the product with wet hands.
 - Do not use the product if the power plug is not fully inserted into the power outlet.
 - Do not expose the power plug and terminals to dirt or let them come into contact with metallic pins or other metal objects.
 - Do not touch the battery charger or AC adapter connected to a power outlet during lightning storms.
 - Do not place heavy objects on the power cord. Do not damage, break or modify the power cord.
 - Do not wrap the product in cloth or other materials when in use or shortly after use when the product is still warm in temperature.
 - Do not leave the product connected to a power source for long periods of time.

This may cause electric shock, explosion or fire.

Before Use

Basic Guide

Advanced Guide

Camera Basics

Auto Mode /
Hybrid Auto Mode

Other Shooting Modes

P Mode

Tv, Av, and M Mode

Playback

Wireless Features

Setting Menu

Accessories

Appendix

Index



- Do not allow the product to maintain contact with the same area of skin for extended periods of time during use.

This may result in low-temperature contact burns, including skin redness and blistering, even if the product does not feel hot. The use of a tripod or similar equipment is recommended when using the product in hot places and for people with circulation problems or less sensitive skin.

- Follow any indications to turn off the product in places where its use is forbidden.

Not doing so may cause other equipment to malfunction due to the effect of electromagnetic waves and even result in accidents.

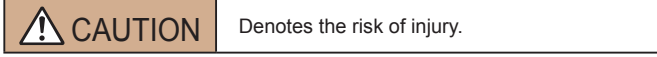

Denotes the risk of injury.

- Do not fire the flash near the eyes. It may hurt the eyes.

- Strap is intended for use on the body only. Hanging the strap with any product attached on a hook or other object may damage the product. Also, do not shake the product or expose the product to strong impacts.

- Do not apply strong pressure on the lens or allow an object to hit it. This may cause injury or damage to the product.

- Flash emits high temperatures when fired. Keep fingers, any other part of your body, and objects away from the flash unit while taking pictures.

This may cause burns or malfunction of the flash.

- Do not leave the product in places exposed to extremely high or low temperatures.

The product may become extremely hot/cold and cause burns or injury when touched.

CAUTION

Denotes the possibility of property damage.

- Do not aim the camera at intense light sources, such as the sun on a clear day or an intense artificial light source.

Doing so may damage the image sensor or other internal components.

- When using the camera on a sandy beach or at a windy location, be careful not to allow dust or sand to enter the camera.

- Wipe off any dust, grime, or other foreign matter on the flash with a cotton swab or cloth.

The heat emitted from the flash may cause foreign matter to smoke or the product to malfunction.

- Remove and store the battery pack/batteries when you are not using the product.

Any battery leakage that occurs may cause product damage.

- Before you discard the battery pack/batteries, cover the terminals with tape or other insulators.

Contacting other metal materials may lead to fire or explosions.

- Unplug any battery charger used with the product when not in use. Do not cover with a cloth or other objects when in use.

Leaving the unit plugged in for a long period of time may cause it to overheat and distort, resulting in fire.

- Do not leave any dedicated battery packs near pets.

Pets biting the battery pack could cause leakage, overheating, or explosion, resulting in product damage or fire.

- If your product uses multiple batteries, do not use batteries that have different levels of charge together, and do not use old and new batteries together. Do not insert the batteries with the + and – terminals reversed.

This may cause the product to malfunction.

- Do not sit down with the camera in your pant pocket.

Doing so may cause malfunctions or damage the screen.

Before Use

Basic Guide

Advanced Guide

Camera Basics

Auto Mode /
Hybrid Auto Mode

Other Shooting Modes

P Mode

Tv, Av, and M Mode

Playback

Wireless Features

Setting Menu

Accessories

Appendix

Index



Basic Guide

Basic Operations

Basic information and instructions, from initial preparations to shooting and playback

Initial Preparations

Prepare for shooting as follows.

Attaching the Strap

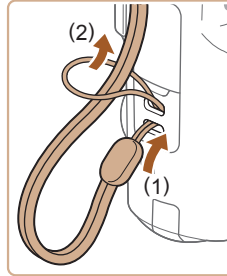

- Thread the end of the strap through the strap mount (1), and then pull the other end of the strap through the loop on the threaded end (2).

Holding the Camera

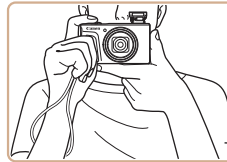

- Place the strap around your wrist.
- When shooting, keep your arms close to your body and hold the camera securely to prevent it from moving. If you have raised the flash, do not rest your fingers on it.

Before Use

Basic Guide

Advanced Guide

Camera Basics

Auto Mode /
Hybrid Auto Mode

Other Shooting Modes

P Mode

Tv, Av, and M Mode

Playback

Wireless Features

Setting Menu

Accessories

Appendix

Index

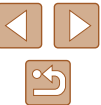

Charging the Battery Pack

Before use, charge the battery pack with the included charger. Be sure to charge the battery pack initially, because the camera is not sold with the battery pack charged.

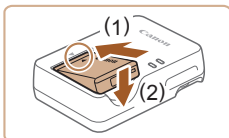

1 Insert the battery pack.

- After aligning the ▲ marks on the battery pack and charger, insert the battery pack by pushing it in (1) and down (2).

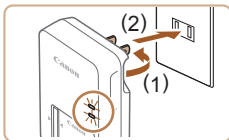

2 Charge the battery pack.

- Plug the battery charger into a power outlet as shown.
- If your battery charger has a power cord, connect the power cord to the charger, and then plug the other end into the power outlet.
- The charging lamp turns orange, and charging begins.
- When charging is finished, the lamp turns green.

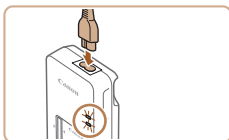

3 Remove the battery pack.

- After unplugging the battery charger, remove the battery pack by pushing it in (1) and up (2).

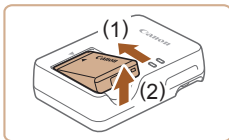

- To protect the battery pack and keep it in optimal condition, do not charge it continuously for more than 24 hours.



- Charged battery packs gradually lose their charge, even when they are not used. Charge the battery pack on (or immediately before) the day of use.
- The charger can be used in areas with 100 – 240 V AC power (50/60 Hz). For power outlets in a different format, use a commercially available adapter for the plug. Never use an electrical transformer designed for traveling, which may damage the battery pack.

Inserting the Battery Pack and Your Memory Card

Insert the included battery pack and a memory card (sold separately). Note that before using a memory card that is new or has been formatted in another device, you should format the memory card with this camera (102).

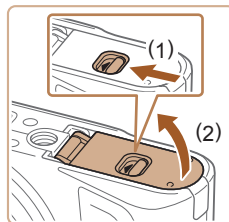

1 Open the cover.

- Slide the switch (1) and open the cover (2).

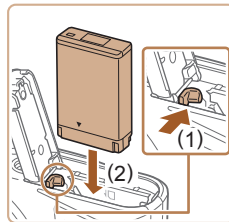

2 Insert the battery pack.

- Push the battery lock toward (1) and insert the battery pack toward (2) until the lock clicks shut.
- If you insert the battery pack facing the wrong way, it cannot be locked into the correct position. Always confirm that the battery pack is facing the right way and locks when inserted.

Before Use

Basic Guide

Advanced Guide

Camera Basics

Auto Mode /
Hybrid Auto Mode

Other Shooting Modes

P Mode

Tv, Av, and M Mode

Playback

Wireless Features

Setting Menu

Accessories

Appendix

Index



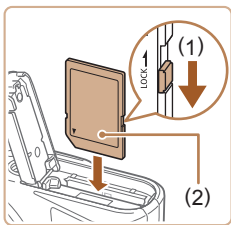

3 Check your card's write-protect switch and insert the memory card.

- Recording is not possible on memory cards with a write-protect switch when the switch is in the locked position. Move the switch toward (1).
- Insert the memory card with the label (2) facing as shown until it clicks into place.
- Make sure the memory card is facing the right way when you insert it. Inserting memory cards facing the wrong way may damage the camera.

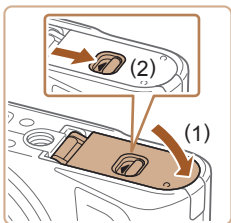

4 Close the cover.

- Lower the cover (1) and hold it down as you slide the switch, until it clicks into the closed position (2).

Removing the Battery Pack and Memory Card

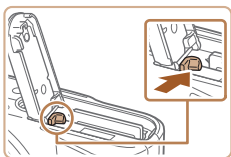

Remove the battery pack.

- Open the cover and press the battery lock in the direction of the arrow.
- The battery pack will pop up.

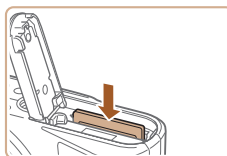

Remove the memory card.

- Push the memory card in until it clicks, and then slowly release it.
- The memory card will pop up.

Setting the Date, Time, and Time Zone

Set the current date and time. Information you specify this way is recorded in image properties when you shoot, and it is used when you manage images by shooting date or print images showing the date.

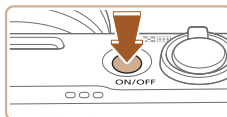

1 Turn the camera on.

- Press the power button.
- The [Date/Time/Zone] screen is displayed.

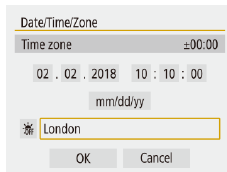

2 Set the time zone.

- Press the ◀/▶ buttons to choose the item, and then press the Ⓜ button.



Before Use
Basic Guide
Advanced Guide
Camera Basics
Auto Mode / Hybrid Auto Mode
Other Shooting Modes
P Mode
Tv, Av, and M Mode
Playback
Wireless Features
Setting Menu
Accessories
Appendix
Index



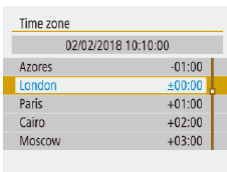

- Press the button again, press the buttons to choose an item, and then press the button.

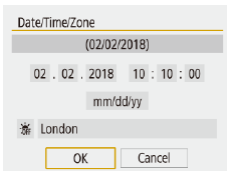

- Choose [OK] to return to [Date/Time/Zone].

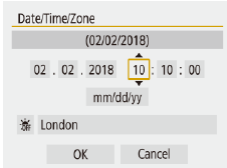

3 Set the date and time.

- Press the buttons to navigate and the button to select an item, press the buttons to adjust the date and time, and then press the button.
- Choose [OK] and press the button.



- Set the current date, time, and zone correctly if the [Date/Time/Zone] screen is displayed when you turn the camera on.



- You can also set the date/time/zone by pressing the **MENU** button and choosing menu (23) > [Date/Time/Zone].
- To set daylight saving time (1 hour ahead), set to on the [Date/Time/Zone] screen.

Display Language



1 Access the menu screen.

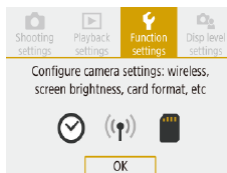

2 Choose the function settings menu.

- Press the buttons to choose , and then press the button.

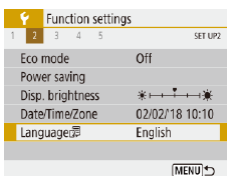

3 Choose [Language].



4 Set the display language.

Before Use
Basic Guide
Advanced Guide
Camera Basics
Auto Mode / Hybrid Auto Mode
Other Shooting Modes
P Mode
Tv, Av, and M Mode
Playback
Wireless Features
Setting Menu
Accessories
Appendix
Index



Viewing

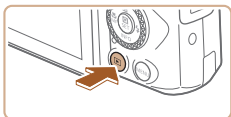

1 Switch to playback.

- Press the button.



2 Choose images.

- To view the previous or next image, press the / buttons or turn the dial.
- Movies are identified by a icon. To play movies, go to step 3.



3 Play movies.

- Press the button, choose , and press the button again.
- Playback now begins, and after the movie is finished, is displayed.
- To adjust the volume, press the / buttons during playback.

Erasing Images

To erase the current image, do the following. Note that erased images cannot be recovered.

1 Press the button.

2 Press the / buttons or turn the dial to choose [Erase], and then press the button.

Before Use

Basic Guide

Advanced Guide

Camera Basics

Auto Mode /
Hybrid Auto Mode

Other Shooting Modes

P Mode

Tv, Av, and M Mode

Playback

Wireless Features

Setting Menu

Accessories

Appendix

Index

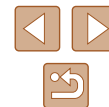

Advanced Guide

Camera Basics

Other basic operations and more ways to enjoy your camera, including shooting and playback options

On/Off





Shooting Mode

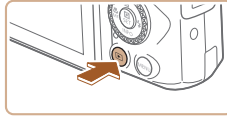

- Press the power button to turn the camera on and prepare for shooting.
- To turn the camera off, press the power button again.



Playback

- Press the  button to turn the camera on and view your shots.
- To turn the camera off, either press the  button again or press the power button.



- To switch to playback from shooting modes, press the  button.
- To switch to shooting mode from playback, press the shutter button halfway (📖21) or turn the mode dial (📖21).
- The lens is retracted after about a minute during playback. You can turn the camera off when the lens is retracted by pressing the  button.

Before Use

Basic Guide

Advanced Guide

Camera Basics

Auto Mode /
Hybrid Auto Mode

Other Shooting Modes

P Mode

Tv, Av, and M Mode

Playback

Wireless Features

Setting Menu

Accessories

Appendix

Index

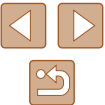

Shutter Button

To ensure your shots are in focus, always begin by holding the shutter button halfway down, and once the subject is in focus, press the button all the way down to shoot.

In this guide, shutter button operations are described as pressing the button *halfway* or *all the way down*.

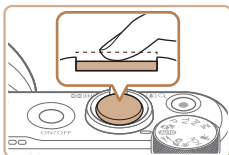

1 Press halfway. (Press lightly to focus.)

- Press the shutter button halfway. The camera beeps twice, and frames are displayed around image areas in focus.

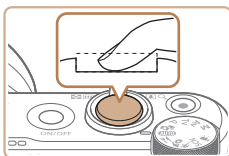

2 Press all the way down. (From the halfway position, press fully to shoot.)

- The camera shoots, as a shutter sound is played.
- Keep the camera still until the shutter sound ends.



- Images may be out of focus if you shoot without initially pressing the shutter button halfway.
- Length of shutter sound playback varies depending on the time required for the shot. It may take longer in some shooting scenes, and images will be blurry if you move the camera (or the subject moves) before the shutter sound ends.

Shooting Modes

Use the mode dial to access each shooting mode.

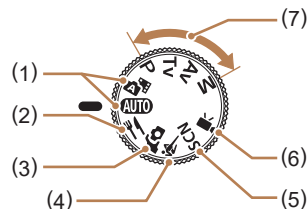

- (1) Auto Mode / Hybrid Auto Mode **AUTO**
Fully automatic shooting, with camera-determined settings (📖18, 📖26, 📖28).
- (2) Food Mode 🍴
Adjust color tones to make food look fresh and vibrant (📖39).
- (3) Self Portrait Mode 📷
Shoot yourself under optimal settings (📖40).
- (4) Sports Mode 🏃
Shoot continuously as the camera focuses on moving subjects (📖41).
- (5) Special Scene Mode **SCN**
Shoot with settings designed for specific scenes, or add a variety of effects (📖41).
- (6) Movie Mode 🎬
For shooting movies (📖47). You can also shoot movies when the mode dial is not set to Movie mode, simply by pressing the movie button.
- (7) P, Tv, Av, and M Modes **P/Tv/Av/M**
Take a variety of shots using your preferred settings (📖51, 📖64).

Before Use

Basic Guide

Advanced Guide

Camera Basics

Auto Mode / Hybrid Auto Mode

Other Shooting Modes

P Mode

Tv, Av, and M Mode

Playback

Wireless Features

Setting Menu

Accessories



Appendix

Index



Shooting Display Options

Press the ▼ button to view other information on the screen, or to hide the information. For details on the information displayed, see “On-Screen Information” (📖119).

	Simple Information Display
	Detailed Information Display
	No Information Display

Adjusting the Screen Angle

You can adjust the screen angle and orientation to suit the scene or how you are shooting.

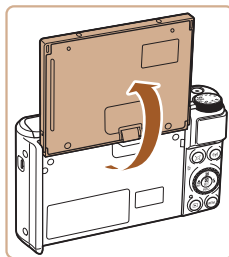

- The screen can be opened to about 180°.
- When including yourself in shots, you can view a mirror image of yourself by rotating the screen around toward the front of the camera.



- When the camera is not in use, keep the screen closed.
- Do not force the screen open any wider, which may damage the camera.



- To cancel reverse display, choose [👤] menu (📖23) > [Reverse display] > [Off].

Before Use

Basic Guide

Advanced Guide

Camera Basics

Auto Mode /
Hybrid Auto Mode

Other Shooting Modes

P Mode

Tv, Av, and M Mode

Playback

Wireless Features

Setting Menu

Accessories

Appendix

Index



Quick Control Screen

Configure commonly used shooting or playback features on the **[Q]** (Quick Control) screen.
Note that setting items and options vary depending on the shooting mode.



1 Access the Quick Control screen.

- Press the **[SET]** button.

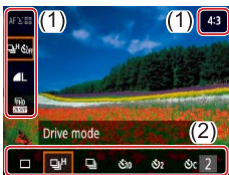

2 Choose a setting item.

- Press the **▲/▼** buttons to choose an item (1).

3 Choose a setting option.

- Press the **◀/▶** buttons to choose an option (2).
- Configure items labeled with a **[MENU]** icon by pressing the **MENU** button.

4 Confirm your choice and exit.

- Press the **[SET]** button.



- You can also configure Quick Control features from the Menu screen.

Menu Screen

Configure a variety of camera functions through the menu screen as follows. Setting items are organized by purpose, such as shooting **[CAM]** or playback **[REVIEW]**, and grouped on multiple tabs. Note that available items vary depending on the selected shooting mode.



1 Access the menu screen.

- Press the **MENU** button.

2 Choose a main tab.

- Press the **◀/▶** buttons to choose a main tab, and then press the **[SET]** button.

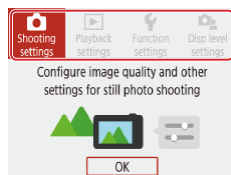

3 Choose a sub-tab.

- Press the **◀/▶** buttons to choose a sub-tab.

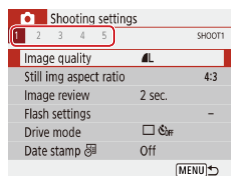

4 Choose a setting item.

- Press the **▲/▼** buttons to choose a setting item, and then press the **[SET]** button.
- Some items are selected with the **▲/▼** buttons on a different screen, after you press the **[SET]** button initially.

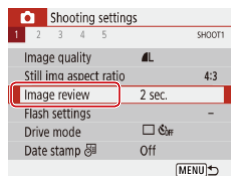

Before Use

Basic Guide

Advanced Guide

Camera Basics

Auto Mode /
Hybrid Auto Mode

Other Shooting Modes

P Mode

Tv, Av, and M Mode

Playback

Wireless Features

Setting Menu

Accessories

Appendix

Index



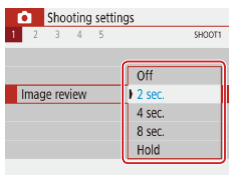

5 Choose a setting option.

- Press the ▲/▼/◀/▶ buttons to choose a setting option, and then press the button.

6 Confirm your choice and exit.

- Press the **MENU** button to return to the screen in step 2, and press it again to return to the shooting screen.

On-Screen Keyboard

Use the on-screen keyboard to enter information. Note that the length and type of information you can enter varies depending on the function you are using.



Entering Characters

- Press the ▲/▼/◀/▶ buttons or turn the dial to choose the key of your desired character, and then press the button.
- To enter uppercase letters, choose and press the button.
- The amount of information you can enter (1) varies depending on the function you are using.

Moving the Cursor

- Choose or and press the button.

Switching Input Modes

- Choose and press the button.
- Available input modes vary depending on the function you are using.

Deleting Characters

- Choose and press the button. The previous character will be deleted.

Returning to the Previous Screen

- Press the **MENU** button.

- Before Use
- Basic Guide
- Advanced Guide
 - Camera Basics
 - Auto Mode / Hybrid Auto Mode
 - Other Shooting Modes
 - P Mode
 - Tv, Av, and M Mode
 - Playback
 - Wireless Features
 - Setting Menu
 - Accessories
 - Appendix
- Index

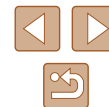

Indicator Display

The indicator on the back of the camera (📖4) lights up or blinks depending on the camera status.

Color	Indicator Status	Camera Status
Green	On	Recording stills to the memory card, or reading stills from the card
Green	Slow blinking	Display off
Green	Blinking	Recording movies to the memory card, reading movies from the card, or transmitting via Wi-Fi
Orange	On	Charging via USB
Orange	Blinking	USB charging error



- When card reading/writing is in progress, do not turn the camera off, open the memory card/battery cover, or shake or hit the camera. Doing so may corrupt images or damage the camera or memory card.

Frames on the Shooting Screen

White frame	Displayed around the subject or person's face detected as the main subject. When multiple subjects are detected, gray frames are displayed on subjects other than the main subject.
Green frame	Displayed after the camera focuses when you press the shutter button halfway.
Blue frame	Displayed as the camera continues to focus on moving subjects. Shown as long as you press the shutter button halfway.
Yellow frame	Displayed if the camera cannot focus when you press the shutter button halfway.



- Try shooting in **P** mode (📖51) if no frames are displayed, if frames are not displayed around desired subjects, or if frames are displayed on the background or similar areas.

Before Use

Basic Guide

Advanced Guide

Camera Basics

Auto Mode /
Hybrid Auto Mode

Other Shooting Modes

P Mode

Tv, Av, and M Mode

Playback

Wireless Features

Setting Menu

Accessories

Appendix

Index



Auto Mode / Hybrid Auto Mode

Convenient mode for easy shots with greater control over shooting

Shooting with Camera-Determined Settings

Use Auto mode for fully automatic selection of the optimal settings for the scene, based on the subject and shooting conditions determined by the camera.

Shooting (Smart Auto)

► Still Images ► Movies

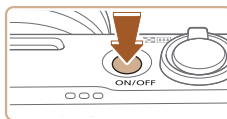

1 Turn the camera on.



2 Enter AUTO mode.

- Aim the camera at the subject. The camera will make a slight clicking noise as it determines the scene.
- Icons representing the scene (1) and image stabilization mode (2) are displayed in the upper left of the screen (📖29, 📖30).
- Frames displayed around any detected subjects indicate that they are in focus.



Before Use
Basic Guide
Advanced Guide
Camera Basics
Auto Mode / Hybrid Auto Mode
Other Shooting Modes
P Mode
Tv, Av, and M Mode
Playback
Wireless Features
Setting Menu
Accessories
Appendix
Index



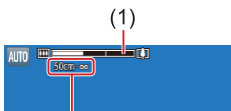
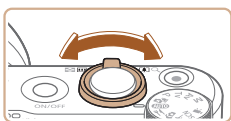

(2)

3 Zoom in or out, as needed.

- Move the zoom lever left or right.
- A zoom bar (1) showing the zoom position is displayed, along with the range of focus (2).

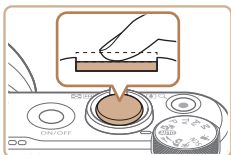

4 Shoot.

Shooting Still Images

1) Focus.

- Press the shutter button halfway. The camera beeps twice after focusing, and frames are displayed to indicate image areas in focus.
- Several frames are displayed when multiple areas are in focus.

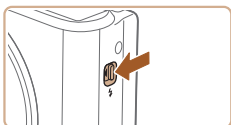

- To use the flash, raise it by moving the ⚡ switch. It will fire when shooting in low-light conditions. If you prefer not to use the flash, push it down with your finger, into the camera.

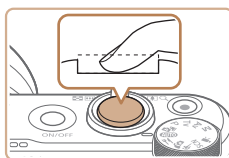

2) Shoot.

- Press the shutter button all the way down.
- As the camera shoots, a shutter sound is played, and in low-light conditions when you have raised the flash, it fires automatically.
- Keep the camera still until the shutter sound ends.
- After displaying your shot, the camera will revert to the shooting screen.



(1)

(2)



Recording Movies

1) Start recording.

- Press the movie button. Recording begins, and [REC] (2) is displayed with the elapsed time (1).
- Black bars are displayed on the top and bottom edges of the screen, and the subject is slightly enlarged. The black bars indicate image areas not recorded.
- Frames displayed around any detected faces indicate that they are in focus.
- Once recording begins, take your finger off the movie button.

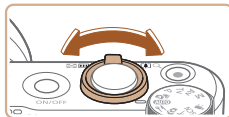

2) Adjust how the shot is composed, as needed.

- To resize the subject, repeat the operations in step 3. However, note that the sound of camera operations will be recorded. Note that movies shot at zoom factors shown in blue will look grainy.
- When you recompose shots, the focus, brightness, and colors will be automatically adjusted.

Before Use
Basic Guide
Advanced Guide
Camera Basics
Auto Mode / Hybrid Auto Mode
Other Shooting Modes
P Mode
Tv, Av, and M Mode
Playback
Wireless Features
Setting Menu
Accessories
Appendix
Index



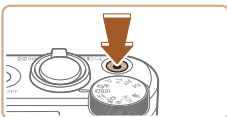

3) Stop recording.

- To stop movie recording, press the movie button again.
- Recording will stop automatically when the memory card becomes full.

Shooting in Hybrid Auto Mode

► Still Images ► Movies

You can make a short movie of the day just by shooting still images. The camera records 2 – 4-second clips of scenes before each shot, which are later combined in a digest movie.



1 Enter mode.



2 Compose the shot.

- Follow steps 3 – 4 in “Shooting (Smart Auto)” (📖26) to compose the shot and focus.
- For more impressive digest movies, aim the camera at subjects about four seconds before shooting still images.

3 Shoot.

- Follow step 4 in “Shooting (Smart Auto)” (📖26) to shoot a still image.
- The camera records both a still image and movie clip. The clip, which ends with the still image and a shutter sound, forms a single chapter in the digest movie.



- Battery life is shorter in this mode than in **AUTO** mode, because digest movies are recorded for each shot.
- A digest movie may not be recorded if you shoot a still image immediately after turning the camera on, choosing  mode, or operating the camera in other ways.
- Sounds and vibrations from operating the camera will be recorded in digest movies.



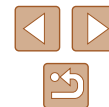

- Digest movie recording size is **[FHD 29.97P]** for NTSC or **[FHD 25.00P]** for PAL. This varies depending on the video output format.
- Sounds are not played when you press the shutter button halfway or trigger the self-timer.
- Digest movies are saved as separate movie files in the following cases even if they were recorded on the same day in  mode.
 - The digest movie file size reaches approximately 4 GB, or the total recording time reaches approximately 29 minutes and 59 seconds.
 - The digest movie is protected.
 - Daylight saving time, video system, or time zone settings are changed.
- Recorded shutter sounds cannot be modified or erased.
- If you prefer to record digest movies without still images, adjust the setting in advance. Choose **[📷]** menu (📖23) > [Digest type] > [No stills].
- Individual chapters can be edited (📖81).

Before Use
Basic Guide
Advanced Guide
Camera Basics
Auto Mode / Hybrid Auto Mode
Other Shooting Modes
P Mode
Tv, Av, and M Mode
Playback
Wireless Features
Setting Menu
Accessories
Appendix
Index





Digest Movie Playback

Display a still image shot in  mode to play the digest movie created on the same day (69).

Still Images



- A blinking  icon warns that images are more likely to be blurred by camera shake. In this case, mount the camera on a tripod or take other measures to keep it still.
- If your shots are dark despite the flash firing, move closer to the subject.
- The subject may be too close if the camera only beeps once when you press the shutter button halfway.
- To reduce red-eye and to assist in focusing, the lamp may be lit when shooting in low-light conditions.
- A blinking  icon displayed when you attempt to shoot indicates that shooting is not possible until the flash has finished recharging. Shooting can resume as soon as the flash is ready, so either press the shutter button all the way down and wait, or release it and press it again.
- Although you can shoot again before the shooting screen is displayed, your previous shot may determine the focus, brightness, and colors used.





- You can change how long images are displayed after shots (38).

Movies



- Keep your fingers away from the microphone (1) while recording movies. Blocking the microphone may prevent audio from being recorded or may cause the recording to sound muffled.



- Avoid touching camera controls other than the movie button when recording movies, because sounds made by the camera will be recorded.
- Once movie recording begins, the image display area changes and subjects are enlarged to allow for correction of significant camera shake. To shoot subjects at the same size shown before shooting, follow the steps in "Recording Movies with Subjects at the Same Size Shown before Shooting" (37).
- Individual movies that exceed 4 GB may be divided into multiple files. Automatic playback of divided movie files one after another is not supported. Play each movie separately.
- The camera may use a slower shutter speed under low-light conditions. Slower shutter speeds reduce image noise (Auto slow shutter).
If you prefer smoother movies that are less affected by subject shake, set [Auto slow shutter] to [Disable] in  mode, but note that they may be darker (48).



- Audio is recorded in stereo.

Scene Icons

► Still Images ► Movies

In /AUTO modes, shooting scenes determined by the camera are indicated by the icon displayed, and corresponding settings are automatically selected for optimal focusing, subject brightness, and color.

Before Use

Basic Guide

Advanced Guide

Camera Basics

Auto Mode /
Hybrid Auto Mode

Other Shooting Modes

P Mode

Tv, Av, and M Mode

Playback

Wireless Features

Setting Menu

Accessories

Appendix

Index





- Try shooting in **P** mode (📖51) if the scene icon does not match actual shooting conditions, or if it is not possible to shoot with your expected effect, color, or brightness.

Image Stabilization Icons

▶ Still Images ▶ Movies

Optimal image stabilization for the shooting conditions (Intelligent IS) is automatically applied, and the following icons are displayed.

	Image stabilization for still images (Normal)
	Image stabilization for still images when panning (Panning)*
	Image stabilization for angular camera shake and shift-shake in macro shots (Hybrid IS). For movies, is displayed and image stabilization is also applied.
	Image stabilization for movies, reducing strong camera shake, as when recording while walking (Dynamic)
	Image stabilization for slow camera shake, such as when recording movies at telephoto (Powered)
	No image stabilization, because the camera is mounted on a tripod or held still by other means. However, during movie recording, is displayed, and image stabilization to counteract wind or other sources of vibration is used (Tripod IS).

* Displayed when you pan, following moving subjects with the camera. When you follow subjects moving horizontally, image stabilization only counteracts vertical camera shake, and horizontal stabilization stops. Similarly, when you follow subjects moving vertically, image stabilization only counteracts horizontal camera shake.



- To cancel image stabilization, set [IS mode] to [Off] (📖36). In this case, an IS icon is not displayed.
- is not available in mode.

Common, Convenient Features

Zooming In Closer on Subjects (Digital Zoom)

▶ Still Images ▶ Movies

When distant subjects are too far away to enlarge using the optical zoom, use digital zoom for up to about 160x enlargement.

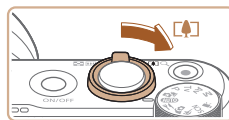

1 Move the zoom lever toward .

- Hold the lever until zooming stops.
- Zooming stops at the largest zoom factor before the image becomes noticeably grainy, which is then indicated on the screen.

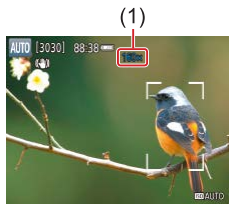

2 Move the zoom lever toward again.

- The camera zooms in even closer on the subject.
- (1) is the current zoom factor.



- Moving the zoom lever will display the zoom bar (which indicates the zoom position). The zoom bar is color-coded to indicate the zoom range.
 - White range: optical zoom range where the image will not appear grainy.
 - Yellow range: digital zoom range where the image is not noticeably grainy (ZoomPlus).
 - Blue range: digital zoom range where the image will appear grainy.
- Because the blue range will not be available at some recording pixel settings (📖35), the maximum zoom factor can be achieved by following step 1.

Before Use

Basic Guide

Advanced Guide

Camera Basics

Auto Mode / Hybrid Auto Mode

Other Shooting Modes

P Mode

Tv, Av, and M Mode

Playback

Wireless Features

Setting Menu

Accessories

Appendix

Index





- To deactivate digital zoom, choose [Camera] menu (23) > [Digital zoom] > [Off].

Easily Reacquiring Subjects after Manual Zooming (Framing Assist – Seek)

► Still Images ► Movies

If you lose track of a subject while zoomed in, you can find it more easily by temporarily zooming out.



1 Look for the lost subject.

- Press and hold the ZOOM OUT button.
- The camera zooms out and displays a white frame around the area shown before you pressed the ZOOM OUT button.



2 Reacquire the subject.

- Aim the camera so that the subject enters the white frame, and then release the ZOOM OUT button.
- The previous magnification is now restored, so that the area within the white frame fills the screen again.



- Some shooting information is not displayed while the camera is zoomed out.
- During movie shooting, the white frame is not displayed if you press the ZOOM OUT button. Also note that a changed zoom factor and camera operating sounds are recorded.



- If you prefer to shoot at the zoom factor of the screen in step 1, press the shutter button all the way down.
- You can adjust the zoom factor that the camera reverts to when you release the ZOOM OUT button by moving the zoom lever to resize the white frame while you hold the ZOOM OUT button.
- To adjust the area displayed when the ZOOM OUT button is pressed, choose [ZOOM OUT Display area] in the [Camera] menu (23), and choose one of the three options.
- The zoom factor cannot be changed with the ZOOM OUT button after you press the shutter button all the way down in self-timer mode (33).

Auto Zooming in Response to Subject Movement (Auto Zoom)

► Still Images ► Movies

The camera automatically zooms in and out to keep a detected face (58) at a constant size. If the person moves closer, the camera automatically zooms out, and vice versa. This size can also be adjusted, as needed.

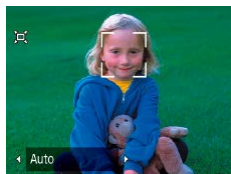

1 Enter ZOOM OUT Auto mode.

- Press and release the ZOOM OUT button quickly.
- [ZOOM OUT] is displayed.
- A white frame is displayed around the detected face, and the camera zooms in and out to keep the subject on the screen.
- When multiple faces are detected, a white frame is displayed around the main subject's face and up to two gray frames around other faces, as the camera zooms to keep these subjects on the screen.

Before Use
Basic Guide
Advanced Guide
Camera Basics
Auto Mode / Hybrid Auto Mode
Other Shooting Modes
P Mode
Tv, Av, and M Mode
Playback
Wireless Features
Setting Menu
Accessories
Appendix
Index



2 Shoot.

- Auto zooming continues even after you shoot, and the frames are still displayed.
- To cancel auto zooming, press the  button again. [Auto: Off] is displayed.





- A face may not be displayed at a constant size relative to the screen at some zoom factors, or if the person's head is tilted or facing the camera indirectly.
- During movie recording, a changed zoom factor and camera operating sounds are recorded.
- When  Auto is on, some shooting information is not displayed, and some shooting settings cannot be configured.
- Auto zooming to keep multiple subjects on the screen is not performed during movie recording, even if faces are detected.
- Auto zooming is not performed during continuous shooting.



- When a detected subject moves toward the edge of the screen, the camera zooms out to keep the subject on the screen.
- The zoom factor cannot be changed after you press the shutter button all the way down in self-timer mode (📖33).
- The camera prioritizes zooming to keep subjects on the screen. For this reason, it may not be possible to maintain a constant face display size, depending on subject movement and shooting conditions.
- When no face is detected, the camera zooms to a certain level and stops zooming until a face is detected.



Adjusting the Constant Face Display Size



- When  Auto is on, press the  /  buttons to choose the desired option.
- The camera zooms automatically to keep faces at the specified size.

Auto	Auto zoom to prevent subjects from moving off the screen. When multiple faces are detected, the camera zooms to keep these subjects on the screen.
Face	Keep faces large enough to show facial expressions clearly.
Upper body	Keep faces small enough to show the person's upper body.
Whole body	Keep faces small enough to show the person's entire body.
Manual	Keep faces at the size specified by moving the zoom lever. Release the zoom lever once the desired size has been obtained.



- The face size can also be adjusted in  menu (📖23) >  Auto zoom].
- You can zoom in or out with the zoom lever when [Face], [Upper body], or [Whole body] is selected, but the original zoom factor will be restored in a few seconds after you release the lever.
- You can clear your specified face size during movie recording by pressing the  button.
- Face sizes cannot be changed during movie recording.

Before Use

Basic Guide

Advanced Guide

Camera Basics

Auto Mode /
Hybrid Auto Mode

Other Shooting Modes

P Mode

Tv, Av, and M Mode

Playback

Wireless Features

Setting Menu

Accessories

Appendix

Index



Adding a Date Stamp

► Still Images ► Movies

The camera can add the shooting date to images, in the lower-right corner.

However, note that date stamps cannot be edited or removed, so confirm beforehand that the date and time are correct (16).

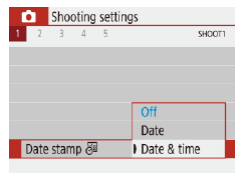

1 Configure the setting.

- Choose [CAMERA] menu (23) > [Date stamp] > [Date & time] or [Date].



2 Shoot.

- As you take shots, the camera adds the shooting date or time to the lower-right corner of images.



- Date stamps cannot be edited or removed.



- Shots taken without adding a date stamp can be printed with one as follows.
However, adding a date stamp this way to images that already have one may cause it to be printed twice.
 - Print using printer functions (113)
 - Use camera DPOF print settings (113) to print

Using the Self-Timer

► Still Images ► Movies

With the self-timer, you can include yourself in group photos or other timed shots. The camera will shoot about 10 seconds after you press the shutter button.

By setting the timer to two seconds, you can also avoid any camera shake from pressing the shutter button.



1 Configure the setting.

- On the Quick Control screen (23), choose [OFF], and then choose [10].

2 Shoot.

- For Still Images: Press the shutter button halfway to focus on the subject, and then press it all the way down.
- Once you start the self-timer, the lamp will blink and the camera will play a self-timer sound.



- Even when set, the self-timer has no effect if you press the movie button to start recording.



- Two seconds before self-timer shots, blinking and self-timer sounds accelerate (unless the flash will fire, in which case the lamp remains lit).

Before Use

Basic Guide

Advanced Guide

Camera Basics

Auto Mode /
Hybrid Auto Mode

Other Shooting Modes

P Mode

Tv, Av, and M Mode

Playback

Wireless Features

Setting Menu

Accessories

Appendix

Index



Continuous Shooting

► Still Images ► Movies

In **AUTO** mode, hold the shutter button all the way down to shoot continuously.



1 Configure the setting.

- On the Quick Control screen (📖23), choose [Off], and then choose [High] or [H].

2 Shoot.

- Hold the shutter button all the way down to shoot continuously.



- During continuous shooting, the focus, exposure, and colors are locked at the position/level determined when you pressed the shutter button halfway.
- Shooting may stop momentarily or continuous shooting may slow down depending on shooting conditions, camera settings, and the zoom position.
- As more shots are taken, shooting may slow down.
- Shooting may slow down if the flash fires.



- Cannot be configured in **AI** mode.

Image Customization Features

Changing the Aspect Ratio

► Still Images ► Movies

Change the image aspect ratio (ratio of width to height) as follows.



- On the Quick Control screen (📖23), choose [4:3], and then choose the desired option.

3:2	Same aspect ratio as 35mm film, used for printing images at 5 x 7-inch or postcard sizes.
4:3	Native aspect ratio of the camera screen. Used for display on standard-definition televisions or similar display devices. Also used for printing images at 3.5 x 5-inch or A-series sizes.
16:9	Used for display on widescreen HDTVs or similar display devices.
1:1	Square aspect ratio.



- Not available in **AI** mode.

Before Use

Basic Guide

Advanced Guide

Camera Basics

Auto Mode /
Hybrid Auto Mode

Other Shooting Modes

P Mode

Tv, Av, and M Mode

Playback

Wireless Features

Setting Menu

Accessories

Appendix

Index

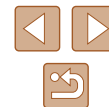

Changing Image Quality

► Still Images ► Movies

Choose from 5 combinations of size (number of pixels) and compression (image quality).

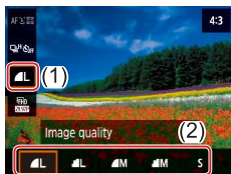

- On the Quick Control screen (p. 23), choose [Image Quality], and then choose the desired option.

Guidelines for Choosing Recording Pixel Setting Based on Paper Size (for 4:3 Images)

	A2 (16.5 x 23.4 in.)
	A3 – A5 (11.7 x 16.5 – 5.8 x 8.3 in.)
	For e-mailing and similar purposes



- Not available in mode.
- and indicate different levels of image quality depending on the extent of compression. At the same size (pixel count), offers higher image quality. Although images have slightly lower image quality, more fit on a memory card.

Helpful Shooting Features

Displaying a Grid

► Still Images ► Movies

Grid lines can be displayed for vertical and horizontal reference as you shoot.



- Choose [Camera] menu (p. 23) > [Grid display], and then choose the desired option.

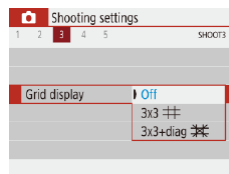

Before Use

Basic Guide

Advanced Guide

Camera Basics

Auto Mode / Hybrid Auto Mode

Other Shooting Modes

P Mode

Tv, Av, and M Mode

Playback

Wireless Features

Setting Menu

Accessories

Appendix

Index



Deactivating Auto Level

▶ Still Images ▶ Movies

Auto leveling keeps movies straight. To cancel this feature, choose [Disable].

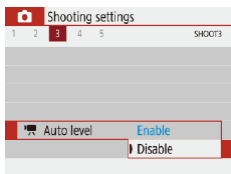

- Choose [CAMERA] menu (📖23) > [Auto level] > [Disable].



- Once recording begins, the display area narrows, and subjects are enlarged (📖37).

Changing the IS Mode Settings

▶ Still Images ▶ Movies

Deactivating Image Stabilization

When the camera is held still (as when shooting from a tripod), you should set image stabilization to [Off] to deactivate it.

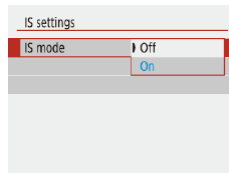

- Choose [CAMERA] menu (📖23) > [IS settings] > [IS mode] > [Off].

Off	Deactivates image stabilization.
On	Optimal image stabilization for the shooting conditions is automatically applied (Intelligent IS) (📖30).

Before Use

Basic Guide

Advanced Guide

Camera Basics

Auto Mode /
Hybrid Auto Mode

Other Shooting Modes

P Mode

Tv, Av, and M Mode

Playback

Wireless Features

Setting Menu

Accessories

Appendix

Index

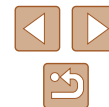

Recording Movies with Subjects at the Same Size Shown before Shooting

▶ Still Images ▶ Movies

Normally, once movie recording begins, the image display area changes and subjects are enlarged to allow for image straightening and correction of significant camera shake.

To record movies with subjects at the same size shown before shooting, you can reduce image stabilization and cancel Auto level.

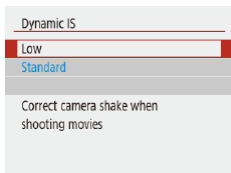

- Choose [CAMERA] menu (📖23) > [Auto level] > [Disable].
- Choose [IS settings] > [Dynamic IS] > [Low].



- You can also set [IS mode] to [Off], so that subjects are recorded at the same size shown before shooting.
- [Dynamic IS] is not available when [IS mode] is set to [Off] (📖36).

Customizing Camera Operation

Customize shooting functions in the [CAMERA] menu (📖23).

Preventing the AF-Assist Beam from Firing

▶ Still Images ▶ Movies

The lamp lights up to help you focus when you press the shutter button halfway in low-light conditions. This lamp can be deactivated.

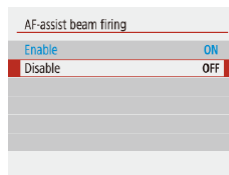

- Set [AF-assist beam firing] to [Disable].

Before Use

Basic Guide

Advanced Guide

Camera Basics

Auto Mode /
Hybrid Auto Mode

Other Shooting Modes

P Mode

Tv, Av, and M Mode

Playback

Wireless Features

Setting Menu

Accessories

Appendix

Index

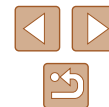

Preventing the Red-Eye Reduction Lamp from Lighting Up

► Still Images ► Movies

A red-eye reduction lamp lights up to reduce red-eye when the flash is used in low-light shots. This lamp can be deactivated.

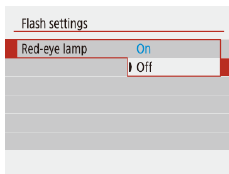

- In [Flash settings], set [Red-eye lamp] to [Off].

Changing the Image Display Period after Shots

► Still Images ► Movies

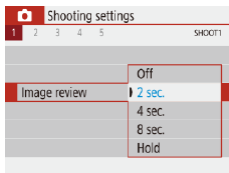

- In [Image review], choose the desired option.

Off	No image display after shots.
2 sec., 4 sec., 8 sec.	Displays images for the specified time. Even while the shot is displayed, you can take another shot by pressing the shutter button halfway again.
Hold	Displays images until you press the shutter button halfway.

Before Use

Basic Guide

Advanced Guide

Camera Basics

Auto Mode /
Hybrid Auto Mode

Other Shooting Modes

P Mode

Tv, Av, and M Mode

Playback

Wireless Features

Setting Menu

Accessories

Appendix

Index

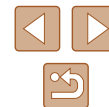

Other Shooting Modes

Shoot more effectively in various scenes, and take shots enhanced with unique image effects or captured using special functions

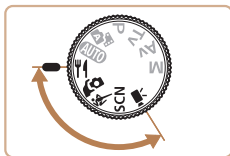

Enhancing Colors in Shots of Food (Food)

► Still Images ► Movies

Adjust color tones to make food look fresh and vibrant.



1 Enter P mode.



2 Change the color tone.

- On the Quick Control screen (23), choose [Color tone] and configure the setting.

3 Shoot.



- These color tones may not look suitable when applied to people.
- In flash shots, color tones are automatically set to the default setting.

Before Use

Basic Guide

Advanced Guide

Camera Basics

Auto Mode /
Hybrid Auto Mode

Other Shooting Modes

P Mode

Tv, Av, and M Mode

Playback

Wireless Features

Setting Menu

Accessories

Appendix

Index



Shooting Yourself under Optimal Settings (Self Portrait)

► Still Images ► Movies

For self-portraits, customizable image processing includes skin smoothing as well as brightness and background adjustment to make yourself stand out.



1 Enter Self Portrait mode.

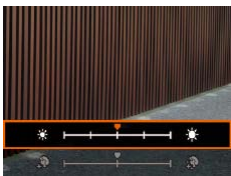

2 Configure the setting.

- Press the **▼** button to access the setting screen, and then configure brightness and skin smoothing.
- After you press the **⊞** button to close the setting screen, you can press the **◀** button to disable the background blur setting.

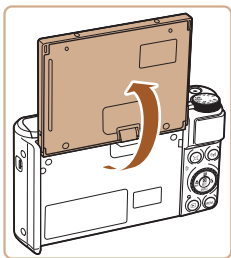

3 Open the screen.

- Open the screen as shown.

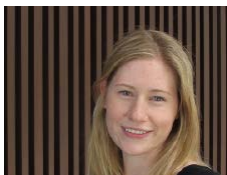

4 Shoot.

- Hold the camera steady as you shoot. When you press the shutter button all the way down with background blur set to [Auto], the camera shoots twice and processes the images.

Smooth skin effect	Choose from three levels of skin smoothing. Skin smoothing is optimized for the main subject's face.
Brightness	Choose from five levels of brightness.
Background blur	Blur the background.



- Areas other than people's skin may be modified, depending on the shooting conditions.
- Try taking some test shots first to make sure you obtain the desired results.



- In [⚡] flash mode, background blur is set to [Off] and cannot be changed.

Before Use

Basic Guide

Advanced Guide

Camera Basics

Auto Mode / Hybrid Auto Mode

Other Shooting Modes

P Mode

Tv, Av, and M Mode

Playback

Wireless Features

Setting Menu

Accessories

Appendix

Index



Moving Subjects (Sports)

► Still Images ► Movies

Shoot continuously as the camera focuses on moving subjects.



1 Enter mode.





2 Focus.

- While you are pressing the shutter button halfway, the camera will continue to adjust focus and image brightness where the blue frame is displayed.

3 Shoot.

- Hold the shutter button all the way down to shoot continuously.



- In  mode, shots may look grainy because the ISO speed (📖53) is increased to suit the shooting conditions.
- There may be a delay after continuous shooting before you can shoot again. Note that some types of memory cards may delay your next shot even longer.
- Shooting may slow down depending on shooting conditions, camera settings, and the zoom position.
- Continuous shooting is not available in  Auto mode (📖31).

Specific Scenes

Choose a mode matching the shooting scene, and the camera will automatically configure the settings for optimal shots.



1 Enter SCN mode.



2 Choose a shooting mode.

- On the Quick Control screen (📖23), choose , and then choose a shooting mode.

3 Shoot.



Shooting Portraits (Portrait)

► Still Images ► Movies

- Take shots of people with a softening effect.



Shooting Evening Scenes without Using a Tripod (Handheld Night Scene)

► Still Images ► Movies

- Beautiful shots of evening scenes or portraits with evening scenery in the background, without the need to hold the camera very still (as with a tripod).
- A single image is created by combining consecutive shots, reducing camera shake and image noise.

Before Use

Basic Guide

Advanced Guide

Camera Basics

Auto Mode /
Hybrid Auto Mode

Other Shooting Modes

P Mode

Tv, Av, and M Mode

Playback

Wireless Features

Setting Menu

Accessories

Appendix

Index

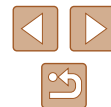



Shooting Fireworks (Fireworks)

► Still Images ► Movies

- Vivid shots of fireworks.



- In [P] mode, shots may look grainy because the ISO speed (p.53) is increased to suit the shooting conditions.
- Because the camera will shoot continuously in [P] mode, hold it steady while shooting.
- In [P] mode, excessive motion blur or certain shooting conditions may prevent you from obtaining the desired results.
- In [SCN] mode, mount the camera on a tripod or take other measures to keep it still and prevent camera shake. Additionally, you should set [IS mode] to [Off] when using a tripod or other means to secure the camera (p.36).



- When you use a tripod for evening scenes, shooting in **AUTO** mode instead of [P] mode will give better results (p.26).
- In [SCN] mode, although no frames are displayed when you press the shutter button halfway, optimal focus is still determined.

Applying Special Effects

Add a variety of effects to images when shooting.



1 Enter SCN mode.

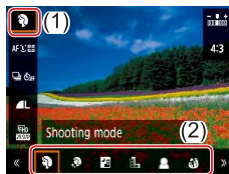

2 Choose a shooting mode.

- On the Quick Control screen (p.23), choose [P], and then choose a shooting mode.



- Try taking some test shots first to make sure you obtain the desired results.

Before Use

Basic Guide

Advanced Guide

Camera Basics

Auto Mode /
Hybrid Auto Mode

Other Shooting Modes

P Mode

Tv, Av, and M Mode

Playback

Wireless Features

Setting Menu

Accessories

Appendix

Index



Shooting with a Skin Smoothing Effect (Smooth Skin)

▶ Still Images ▶ Movies

Processes images to make skin look smoother.

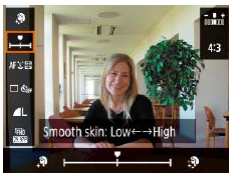

1 Choose [Smooth Skin].

2 Choose an effect level.

- Choose [Smooth skin effect] and configure the setting.
- A preview is shown of how your shot will look with the effect applied.

3 Shoot.



- Areas other than people's skin may be modified, depending on the shooting conditions.

Shooting in Monochrome (Grainy B/W)

▶ Still Images ▶ Movies

Take monochrome pictures with a gritty, rough feeling.



1 Choose [Filter effect].

2 Choose an effect level.

- Choose [Filter effect level] and configure the setting.
- A preview is shown of how your shot will look with the effect applied.

3 Shoot.

Before Use
Basic Guide
Advanced Guide
Camera Basics
Auto Mode / Hybrid Auto Mode
Other Shooting Modes
P Mode
Tv, Av, and M Mode
Playback
Wireless Features
Setting Menu
Accessories
Appendix
Index

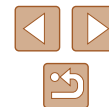

Shooting with a Soft Focus Effect

▶ Still Images ▶ Movies

This function allows you to shoot images as if a soft focus filter were attached to the camera. You can adjust the effect level as desired.

1 Choose [👤].

2 Choose an effect level.

- Choose [Filter effect level] and configure the setting.
- A preview is shown of how your shot will look with the effect applied.

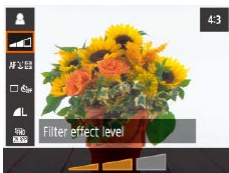

3 Shoot.

Shooting with a Fish-Eye Lens Effect (Fish-Eye Effect)

▶ Still Images ▶ Movies

Shoot with the distorting effect of a fish-eye lens.

1 Choose [👁].

2 Choose an effect level.

- Choose [Filter effect level] and configure the setting.
- A preview is shown of how your shot will look with the effect applied.

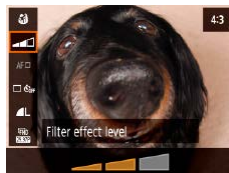

3 Shoot.

Before Use

Basic Guide

Advanced Guide

Camera Basics

Auto Mode /
Hybrid Auto Mode

Other Shooting Modes

P Mode

Tv, Av, and M Mode

Playback

Wireless Features

Setting Menu

Accessories

Appendix

Index

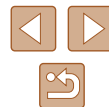

Shots Resembling Oil Paintings (Art Bold Effect)

▶ Still Images ▶ Movies

Make subjects look more substantial, like subjects in oil paintings.



1 Choose [Filter effect level].

2 Choose an effect level.

- Choose [Filter effect level] and configure the setting.
- A preview is shown of how your shot will look with the effect applied.

3 Shoot.

Shots Resembling Watercolors (Water Painting Effect)

▶ Still Images ▶ Movies

Soften colors, for photos resembling watercolor paintings.



1 Choose [Filter effect level].

2 Choose an effect level.

- Choose [Filter effect level] and configure the setting.
- A preview is shown of how your shot will look with the effect applied.

3 Shoot.

Before Use

Basic Guide

Advanced Guide

Camera Basics

Auto Mode /
Hybrid Auto Mode

Other Shooting Modes

P Mode

Tv, Av, and M Mode

Playback

Wireless Features

Setting Menu

Accessories

Appendix

Index

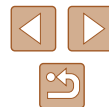

Shooting with a Toy Camera Effect (Toy Camera Effect)

► Still Images ► Movies

This effect makes images resemble shots from a toy camera, with vignetting (darker, blurred image corners) and modified color overall.

1 Choose [📷].

2 Choose a color tone.

- Choose [Type of filter effect] and configure the setting.
- A preview is shown of how your shot will look with the effect applied.

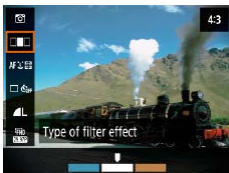

3 Shoot.

Standard	Shots resemble toy camera images.
Warm tone	Images have a warmer tone than with [Standard].
Cool tone	Images have a cooler tone than with [Standard].

Shots Resembling Miniature Models (Miniature Effect)

► Still Images ► Movies

Creates the effect of a miniature model, by blurring image areas above and below your selected area.

1 Choose [📏].

- A white frame is displayed, indicating the image area that will not be blurred.

2 Choose the area to keep in focus.

- Press the ▼ button.
- To move the frame, press the ▲/▼ buttons.
- To move the AF point, press the Ⓢ button and then the ▲/▼/◀/▶ buttons.



3 Return to the shooting screen and shoot.

- Press the Ⓢ button to return to the shooting screen, and then shoot.



- To switch the orientation of the frame (from horizontal to vertical or vice-versa), press the ◀/▶ buttons in step 2. You can move the frame in vertical orientation by pressing the ◀/▶ buttons.

Before Use

Basic Guide

Advanced Guide

Camera Basics

Auto Mode /
Hybrid Auto Mode

Other Shooting Modes

P Mode

Tv, Av, and M Mode

Playback

Wireless Features

Setting Menu

Accessories

Appendix

Index

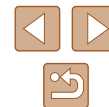

Recording Various Movies

▶ Still Images ▶ Movies



1 Enter **MOVIE** mode.

- Black bars are displayed on the top and bottom edges of the screen, and the subject is slightly enlarged. The black bars indicate image areas not recorded.

2 Shoot.

- Press the movie button.
- To stop movie recording, press the movie button again.

Changing Movie Recording Size

▶ Still Images ▶ Movies

Set the movie recording size and frame rate. The frame rate indicates how many frames are recorded per second, and available options depend on the NTSC or PAL setting.



- On the Quick Control screen (📖23), choose **[4K 29.97P]**, and then choose the desired option.



- Subjects are displayed larger for 4K movies than in other modes.
- If the camera temporarily overheats during extended 4K recording, **[H]** is displayed and recording stops. At this time, movie recording will be unavailable, even if you press the movie button. Following the instructions displayed, either choose a movie recording size other than **[4K 29.97P]** or **[4K 25.00P]** or turn off the camera to let it cool down before you resume recording.

Adjusting Image Brightness (Exposure Compensation)

▶ Still Images ▶ Movies

The standard exposure set by the camera can be adjusted in 1/3-stop increments, in a range of -3 to +3.

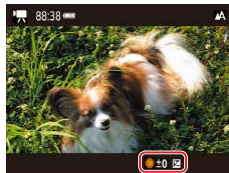

- Press the **▲** button. As you watch the screen, turn the **DISC** dial to adjust brightness, and then press the **▲** button again when finished.



- Image brightness can also be locked, as described in “Locking Image Brightness / Exposure (AE Lock)” (📖52).

Before Use
Basic Guide
Advanced Guide
Camera Basics
Auto Mode / Hybrid Auto Mode
Other Shooting Modes
P Mode
Tv, Av, and M Mode
Playback
Wireless Features
Setting Menu
Accessories
Appendix
Index

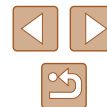

Disabling Auto Slow Shutter

▶ Still Images ▶ Movies

Auto slow shutter can be disabled if movement in [FHD 59.94P], [4HD 59.94P], [FHD 50.00P], or [4HD 50.00P] movies is rough. However, under low light, movies may look dark.

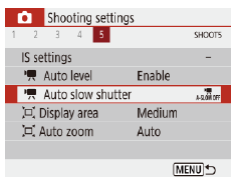

- Choose [CAMERA] menu (23) > [Auto slow shutter] > [Disable].

Correcting Severe Camera Shake

▶ Still Images ▶ Movies

Counteract severe camera shake, such as when recording while moving. The portion of images displayed changes more than for [Standard], and subjects are further enlarged.

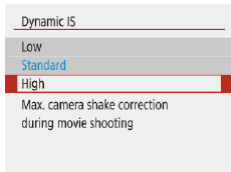

- Choose [CAMERA] menu (23) > [IS settings] > [Dynamic IS] > [High].



- [Dynamic IS] is not available when [IS mode] is set to [Off] (36).

Sound Settings

▶ Still Images ▶ Movies

Deactivating the Wind Filter

Noise caused by strong wind can be reduced. However, the recording may sound unnatural when this option is used when there is no wind. In this case, you can deactivate the wind filter.

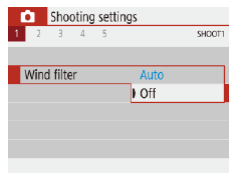

- Choose [CAMERA] menu (23) > [Wind filter] > [Off].

Using the Attenuator

The attenuator can reduce audio distortion in noisy environments. However, in quiet environments, it lowers the sound-recording level.

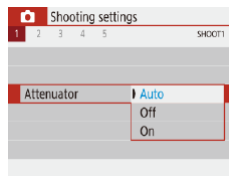

- Choose [CAMERA] menu (23) > [Attenuator], and then choose the desired option.

Before Use

Basic Guide

Advanced Guide

Camera Basics

Auto Mode /
Hybrid Auto Mode

Other Shooting Modes

P Mode

Tv, Av, and M Mode

Playback

Wireless Features

Setting Menu

Accessories

Appendix

Index



Recording Time-Lapse Movies

▶ Still Images ▶ Movies

Time-lapse movies combine images that are shot automatically at a specified interval. Any gradual changes of the subject (such as changes in a landscape) are played back in fast motion.

1 Access the [Time-lapse movie settings] screen.

- Choose [📷] menu (📖23) > [Time-lapse movie].

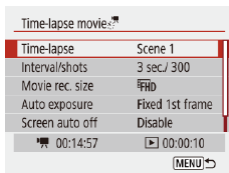

2 Configure the setting.

- In [Time-lapse], choose a scene.
- Choose an item, and then choose the desired option.
- Set [Screen auto off] to [Disable] to keep the screen on for 30 minutes after you start shooting. Set it to [Enable] to turn the screen off about 10 seconds after the first frame is captured. To activate or deactivate the screen during recording, press the ▼ button.
- As you configure the items, the time required (🕒) and movie playback time (▶) are displayed.

3 Return to the shooting screen.

- Press the MENU button to return to the shooting screen. To focus on the subject, press the shutter button halfway.
- Press the movie button.



- Do not disturb the camera while recording.
- To cancel recording, press the movie button again.
- Fast-moving subjects may look distorted in movies.
- Sound is not recorded.

Miniature Model Effect in Movies (Miniature Effect Movie)

▶ Still Images ▶ Movies

Creates the effect of a miniature model in movies, by blurring image areas outside a selected area.



1 Configure the setting.

- On the Quick Control screen (📖23), choose [📷OFF], and then choose an option.

2 Choose the area to keep in focus.

- Press the ▼ button.
- To move the frame, press the ▲/▼ buttons.
- To move the AF point, press the Ⓢ button and then the ▲/▼/◀/▶ buttons.

3 Return to the shooting screen and shoot.

- Press the Ⓢ button to return to the shooting screen. To focus on the subject, press the shutter button halfway.
- Press the movie button.

Estimated Playback Time (for One-Minute Clips)

Speed	Playback Time
5x	Approx. 12 sec.
10x	Approx. 6 sec.
20x	Approx. 3 sec.

Before Use

Basic Guide

Advanced Guide

Camera Basics

Auto Mode / Hybrid Auto Mode

Other Shooting Modes

P Mode

Tv, Av, and M Mode

Playback

Wireless Features

Setting Menu

Accessories

Appendix

Index





- Sound is not recorded.
- Set the movie recording size to [FHD 29.97P] or [FHD 25.00P].

Recording Video Snapshots

▶ Still Images ▶ Movies

Record a series of 4, 6, or 8 sec. video snapshots, and the camera will combine them to create a video snapshot album that shows these highlights of your trip or event.

Video snapshot	
Video snapshot	Enable
Album settings	New album
Playback time	4 sec.
Playback effect	1x speed
Show confirm msg	Enable
Time required	4 sec.

1 Enable video snapshots.

- Choose [📷] menu (📖23) > [Video snapshot] > [Enable].

2 Configure the setting.

- Choose an item to configure, and then choose the desired option.

Playback time	Choose the video snapshot playback time.
Playback effect	Choose the video snapshot playback effect.
Show confirm msg	Choose whether to display a confirmation message after each video snapshot is recorded.

- The time required to record a video snapshot is indicated, based on the playback time and effect.
- After your first video snapshot is recorded, in [Album settings], you can choose which album to save your next video snapshot to.

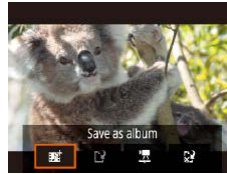
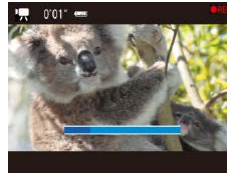

3 Shoot.

- Press the **MENU** button to return to the shooting screen, and then press the movie button.
- A bar showing the elapsed time is displayed, and recording stops automatically when finished.

4 Save to an album.

- This message is not displayed if you set [Show confirm msg] to [Disable] in step 2, and the video snapshot is automatically saved to the album you selected in [Album settings] in step 2.
- Repeat steps 3 – 4 as needed.

5 Disable video snapshots.

- On the Quick Control screen (📖23), choose [📷].



- Video snapshots are saved to a new album when the recording time of the current album exceeds 5 min.
- The indicated playback time per video snapshot is only a guideline.
- Set the movie recording size to [FHD 29.97P] or [FHD 25.00P].
- Any video snapshots that you manually stop recording are saved as normal movies.
- No sound is recorded when you set [Playback effect] to [2x speed] or [1/2x speed].

Before Use

Basic Guide

Advanced Guide

Camera Basics

Auto Mode / Hybrid Auto Mode

Other Shooting Modes

P Mode

Tv, Av, and M Mode

Playback

Wireless Features

Setting Menu

Accessories

Appendix

Index

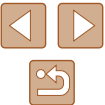

P Mode

More discerning shots, in your preferred shooting style



- Instructions in this chapter apply to the camera with the mode dial set to **P** mode. Some **P** mode features are also available in other modes.
- **P**: Program AE; AE: Auto Exposure

Shooting in Program AE (P Mode)

► Still Images ► Movies

You can customize many function settings to suit your preferred shooting style.



- 1 Enter **P** mode.
- 2 Customize the settings as desired (📖52 – 📖63), and then shoot.



- If standard exposure cannot be obtained when you press the shutter button halfway, the shutter speed and aperture value blink in white. In this case, try adjusting the ISO speed (📖53) or activating the flash (if subjects are dark, 📖61), which may enable standard exposure.
- Movies can be recorded in **P** mode as well, by pressing the movie button. However, some Quick Control (📖23) and MENU (📖23) settings may be automatically adjusted for movie recording.
- You can adjust the combination of shutter speed and aperture value by pressing the shutter button halfway and turning the  dial (Program Shift).

Before Use

Basic Guide

Advanced Guide

Camera Basics

Auto Mode /
Hybrid Auto Mode

Other Shooting Modes

P Mode

Tv, Av, and M Mode

Playback

Wireless Features

Setting Menu

Accessories

Appendix

Index

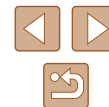
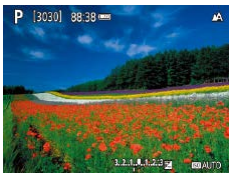



Image Brightness (Exposure)

Adjusting Image Brightness (Exposure Compensation)

▶ Still Images ▶ Movies

The standard exposure set by the camera can be adjusted in 1/3-stop increments, in a range of -3 to +3.



- Press the ▲ button. As you watch the screen, turn the  dial to adjust brightness, and then press the ▲ button again when finished.

Locking Image Brightness / Exposure (AE Lock)

▶ Still Images ▶ Movies

Before shooting, you can lock the exposure, or you can specify focus and exposure separately.



1 Lock the exposure.

- Aim the camera at the subject to shoot with the exposure locked. With the shutter button pressed halfway, press the ▲ button.
- [✕] is displayed, and the exposure is locked.
- This setting is unlocked automatically after the metering timer runs out.

2 Compose the shot and shoot.

- AE is unlocked once [✕] is no longer displayed.





- In **P**, **Tv**, **Av**, **M**, or  mode, an exposure value is displayed based on the time set in [Metering timer] in the  menu (23).



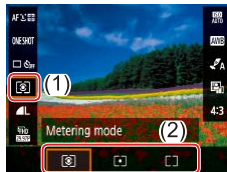

Changing the Metering Method

▶ Still Images ▶ Movies

Adjust the metering method (how brightness is measured) to suit shooting conditions as follows.



- On the Quick Control screen (23), choose , and then choose the desired option.

 Evaluative metering	For typical shooting conditions, including backlit shots. Automatically adjusts exposure to match the shooting conditions.
 Spot metering	Metering restricted to within the  (Spot AE Point frame), displayed in the center of the screen.
 Center-weighted average	Determines the average brightness of light across the entire image area, calculated by treating brightness in the central area as more important.

Before Use

Basic Guide

Advanced Guide

Camera Basics

Auto Mode /
Hybrid Auto Mode

Other Shooting Modes

P Mode

Tv, Av, and M Mode

Playback

Wireless Features

Setting Menu

Accessories

Appendix

Index



Changing the ISO Speed

► Still Images ► Movies

Set the ISO speed to [AUTO] for automatic adjustment to suit the shooting mode and conditions. Otherwise, set a higher ISO speed for higher sensitivity, or a lower value for lower sensitivity.

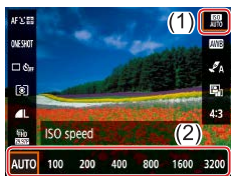

- On the Quick Control screen (23), choose [ISO], and then choose the desired option.



- Although choosing a lower ISO speed may reduce image graininess, there may be a greater risk of subject and camera shake in some shooting conditions.
- Choosing a higher ISO speed will increase shutter speed, which may reduce subject and camera shake and increase the flash range. However, shots may look grainy.

Auto Correction of Brightness and Contrast (Auto Lighting Optimizer)

► Still Images ► Movies

Correct brightness and contrast automatically to avoid images that are too dark or have too little or too much contrast.



- On the Quick Control screen (23), choose [ALO], and then choose the desired option.



- This feature may increase noise under some shooting conditions.
- If Auto Lighting Optimizer makes images too bright, set it to [Off1] or [Off2].
- Images may still be bright or the effect of exposure compensation may be weak under a setting other than [Off1] if you use a darker setting for exposure compensation or flash exposure compensation. For shots at your specified brightness, set this feature to [Off2].

Before Use

Basic Guide

Advanced Guide

Camera Basics

Auto Mode /
Hybrid Auto Mode

Other Shooting Modes

P Mode

Tv, Av, and M Mode

Playback

Wireless Features

Setting Menu

Accessories

Appendix

Index

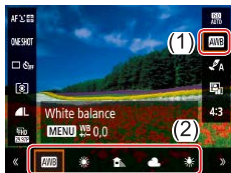

Image Colors

Capturing Natural Colors (White Balance)

► Still Images ► Movies

By adjusting white balance (WB), you can make image colors look more natural for the scene you are shooting.



- On the Quick Control screen (📖23), choose [WB], and then choose the desired option.

	Auto	Automatically sets the optimal white balance for the shooting conditions.
	Daylight	For shooting outdoors in fair weather.
	Shade	For shooting in the shade.
	Cloudy	For shooting in cloudy weather or at dusk.
	Tungsten light	For shooting under ordinary incandescent lighting.
	White fluorescent light	For shooting under white fluorescent lighting.
	Custom	For manually setting a custom white balance.

Custom White Balance

For image colors that look natural under the light in your shot, adjust white balance to suit the light source where you are shooting. Set the white balance under the same light source that will illuminate your shot.

1 Shoot a white object.

- Shoot with the camera aimed at a sheet of paper or other plain white subject, so that white fills the screen.

2 Choose [WB].

- Follow the steps in “Capturing Natural Colors (White Balance)” (📖54) to choose [WB].

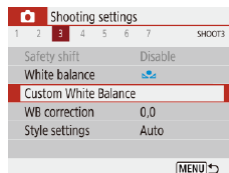
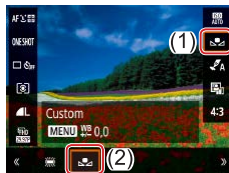

3 Choose [Custom White Balance].

- Choose [WB] menu (📖23) > [Custom White Balance].

4 Load the white data.

- Select your image from step 1, and then press the [WB] button.
- Press the **MENU** button to return to the shooting screen.



Before Use

Basic Guide

Advanced Guide

Camera Basics

Auto Mode /
Hybrid Auto Mode

Other Shooting Modes

P Mode

Tv, Av, and M Mode

Playback

Wireless Features

Setting Menu

Accessories

Appendix

Index

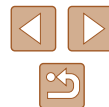



- Capturing a white subject that is too bright or dark may prevent you from setting the white balance correctly.
- A message is displayed on the screen for loading white data if you choose an unsuitable image. Choose [Cancel] to choose a different image. Choose [OK] to use that image for loading white data, but note that it may not produce a suitable white balance.



- Instead of a white object, a gray chart or 18% gray reflector (commercially available) can produce a more accurate white balance.
- The current white balance and related settings are disregarded when you capture a white subject.

Manually Correcting White Balance

You can manually correct white balance. This adjustment can match the effect of using a commercially available color temperature conversion filter or color-compensating filter.

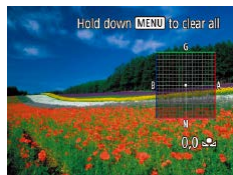

1 Configure the setting.

- Follow the steps in “Capturing Natural Colors (White Balance)” (p.54) to choose the white balance option.

2 Configure advanced settings.

- To configure this setting in detail, press the **MENU** button, and then press the **▲**/**▼**/**◀**/**▶** buttons to adjust the correction level.
- Press the **⏎** button to complete the setting.



- Any correction level you set is retained even if you change the white balance option in step 1.



- B: blue; A: amber; M: magenta; G: green
- One level of blue/amber correction is equivalent to about 5 mireds on a color temperature conversion filter. (Mired: Color temperature unit representing color temperature conversion filter density)

Customizing Colors (Style Settings)

► Still Images ► Movies

Choose color settings that express scenes or subjects well.

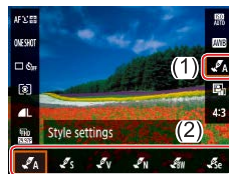

- On the Quick Control screen (p.23), choose [**A**], and then choose the desired option.



- With [**s**], you can press the **MENU** button to adjust contrast, saturation, or other settings.

Before Use
Basic Guide
Advanced Guide
Camera Basics
Auto Mode / Hybrid Auto Mode
Other Shooting Modes
P Mode
Tv, Av, and M Mode
Playback
Wireless Features
Setting Menu
Accessories
Appendix
Index

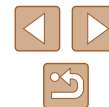

Shooting Range and Focusing

Shooting Close-Ups (Macro)

► Still Images ► Movies

To restrict the focus to subjects at close range, set the camera to [M].



- Press the ◀ button and choose [M].



- If the flash fires, vignetting may occur.
- In the yellow bar display area below the zoom bar, [M] will turn gray and the camera will not focus.



- To prevent camera shake, try mounting the camera on a tripod and shooting with the camera set to [M] (p. 33).

Shooting in Manual Focus Mode

► Still Images ► Movies

When focusing is not possible in AF mode, use manual focus. You can specify the general focal position and then press the shutter button halfway to have the camera determine the optimal focal position near the position you specified.

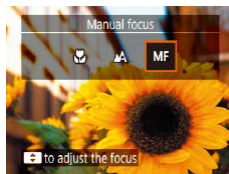



(1)

1 Choose [MF].

- Press the ◀ button and choose [MF].
- [MF] and the MF indicator are displayed.

2 Specify the general focal position.

- Using the on-screen MF indicator ((1), which shows the distance and focal position) as a guide, press the ▲/▼ buttons or turn the  dial to specify the general focal position, and then press the  button.

3 Fine-tune the focus.

- Press the shutter button halfway to have the camera fine-tune the focal position (Safety MF).



- To focus more accurately, try attaching the camera to a tripod to stabilize it.
- To deactivate automatic focus fine-tuning when the shutter button is pressed halfway, choose [CAM] menu (p. 23) > [Safety MF] > [Off].
- For easier manual focusing, choose [CAM] menu (p. 23) > [MF peaking settings] > [Peaking] > [On].

Before Use

Basic Guide

Advanced Guide

Camera Basics

Auto Mode /
Hybrid Auto Mode

Other Shooting Modes

P Mode

Tv, Av, and M Mode

Playback

Wireless Features

Setting Menu

Accessories

Appendix

Index



Easily Identifying the Focus Area (MF Peaking)

Edges of subjects in focus are displayed in color to make manual focusing easier. You can adjust the colors and the sensitivity (level) of edge detection as needed.

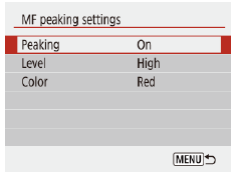

1 Access the setting screen.

- Choose [CAMERA] menu (📖23) > [MF peaking settings] > [On].

2 Configure the setting.

- Choose an item to configure, and then choose the desired option.



- Colors displayed for MF peaking are not recorded in your shots.

Digital Tele-Converter

▶ Still Images ▶ Movies

The focal length of the lens can be increased by approximately 1.6x or 2.0x. This can reduce camera shake because the shutter speed is faster than it would be if you zoomed (including using digital zoom) in to the same zoom factor.

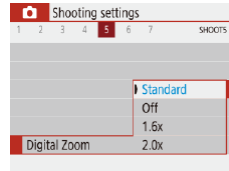

- Choose [CAMERA] menu (📖23) > [Digital zoom], and then choose the desired option.
- The view is enlarged and the zoom factor is displayed on the screen.



- The shutter speed may be equivalent when you move the zoom lever all the way toward [TELE] for maximum telephoto, and when you zoom in to enlarge the subject to the same size following step 2 in "Zooming In Closer on Subjects (Digital Zoom)" (📖30).

Choosing the AF Method

▶ Still Images ▶ Movies

Choose a method of auto focusing (AF) for the subject and scene you are shooting.



- On the Quick Control screen (📖23), choose [AF-ON], and then choose the desired option.

Before Use

Basic Guide

Advanced Guide

Camera Basics

Auto Mode / Hybrid Auto Mode

Other Shooting Modes

P Mode

Tv, Av, and M Mode

Playback

Wireless Features

Setting Menu

Accessories

Appendix

Index

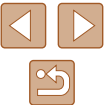



- Focusing may take longer or be incorrect when subjects are dark or lack contrast, or in very bright conditions.

+Tracking

▶ Still Images ▶ Movies

- After you aim the camera at the subject, a white frame is displayed around the face of the main subject as determined by the camera.
- When the camera detects movement, frames will follow moving subjects, within a certain range.
- When no faces are detected, pressing the shutter button halfway displays green frames around other areas in focus.



- Examples of faces that cannot be detected:
 - Subjects that are distant or extremely close
 - Subjects that are dark or light
 - Faces in profile, at an angle, or partly hidden
- The camera may misinterpret non-human subjects as faces.

Choosing Subjects to Focus On (Tracking AF)

▶ Still Images ▶ Movies

Shoot after choosing a subject to focus on as follows.

1 Choose [Tracking AF].

- Follow the steps in “Choosing the AF Method” (📖57) to choose [Tracking AF].
- [AF-ON] is displayed in the center of the screen.



2 Choose a subject to focus on.

- Aim the camera so that [AF-ON] is on the desired subject.
- Press the shutter button halfway. [AF-ON] changes to a blue [AF-ON], which follows the subject as the camera continues to adjust the focus and exposure (Servo AF) (📖59).

3 Shoot.

- Press the shutter button all the way down to shoot.



- [AF operation] (📖59) is set to [Servo AF] and cannot be changed.
- Tracking may not be possible when subjects are too small or move too rapidly, or when subject color or brightness matches that of the background too closely.
- [AF-ON] is not available.



- When shooting in [MF] mode (📖56), press and hold the ◀ button for at least one second.

Before Use

Basic Guide

Advanced Guide

Camera Basics

Auto Mode /
Hybrid Auto Mode

Other Shooting Modes

P Mode

Tv, Av, and M Mode

Playback

Wireless Features

Setting Menu

Accessories

Appendix

Index



Center

► Still Images ► Movies

One AF point is displayed in the center. Effective for reliable focusing.



- To compose shots so that subjects are positioned at the edge or in a corner, first aim the camera to capture the subject in an AF point, and then hold the shutter button halfway down. As you continue to hold the shutter button halfway, recompose the shot as desired, and then press the shutter button all the way down (Focus Lock).

Shooting with Servo AF

► Still Images ► Movies

This mode helps avoid missing shots of subjects in motion, because the camera continues to focus on the subject and adjust the exposure as long as you press the shutter button halfway.



1 Configure the setting.

- On the Quick Control screen (23), choose [ONE SHOT] > [SERVO].



2 Focus.

- The focus and exposure are maintained where the blue AF points are displayed while you are pressing the shutter button halfway.



- Exposure is not locked in Servo AF mode when you press the shutter button halfway but is determined the moment you shoot, regardless of the metering mode (52) setting.
- Depending on the distance to the subject and the subject's speed, the camera may not be able to achieve correct focus.

Before Use
Basic Guide
Advanced Guide
Camera Basics
Auto Mode / Hybrid Auto Mode
Other Shooting Modes
P Mode
Tv, Av, and M Mode
Playback
Wireless Features
Setting Menu
Accessories
Appendix
Index



Changing the Focus Setting

▶ Still Images ▶ Movies

You can change default camera operation of constantly focusing on subjects it is aimed at, even when the shutter button is not pressed. Instead, you can limit camera focusing to the moment you press the shutter button halfway.

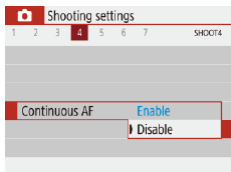

- Choose [CAMERA] menu (23) > [Continuous AF] > [Disable].

Enable	Helps avoid missing sudden photo opportunities, because the camera constantly focuses on subjects until you press the shutter button halfway.
Disable	Conserves battery power, because the camera does not focus constantly. However, this may delay focusing.

Shooting with AF Lock

▶ Still Images ▶ Movies

The focus can be locked. After you lock the focus, the focal position will not change even when you release your finger from the shutter button.

1 Lock the focus.

- With the shutter button pressed halfway, press the ◀ button.
- The focus is now locked, and [MF] and the MF indicator are displayed.
- To unlock the focus, release the shutter button, press the ◀ button again, and choose [A] or [AF-ON].

2 Compose the shot and shoot.

Before Use

Basic Guide

Advanced Guide

Camera Basics

Auto Mode / Hybrid Auto Mode

Other Shooting Modes

P Mode

Tv, Av, and M Mode

Playback

Wireless Features

Setting Menu

Accessories

Appendix

Index



Flash

Changing the Flash Mode

► Still Images ► Movies

You can change the flash mode to match the shooting scene.



- Press the ► button and choose a flash mode.

Auto flash

Fires automatically in low-light conditions.

Flash on

Fires for each shot.

Slow Synchro

Fires to illuminate the main subject (such as people) while shooting at a slower shutter speed to illuminate backgrounds out of flash range.



- In [⚡] mode, mount the camera on a tripod or take other measures to keep it still and prevent camera shake. Additionally, you should set [IS mode] to [Off] when using a tripod or other means to secure the camera (136).
- In [⚡] mode, even after the flash fires, ensure that the main subject does not move until the shutter sound is finished playing.

Flash off

For shooting without the flash.

Before Use
Basic Guide
Advanced Guide
Camera Basics
Auto Mode / Hybrid Auto Mode
Other Shooting Modes
P Mode
Tv, Av, and M Mode
Playback
Wireless Features
Setting Menu
Accessories
Appendix
Index

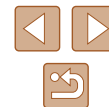

Adjusting the Flash Exposure Compensation

► Still Images ► Movies

Just as with regular exposure compensation (📖52), you can adjust the flash exposure from -2 to +2 stops, in 1/3-stop increments.

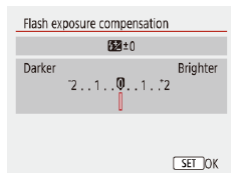

- Configure the setting by choosing [📷] menu (📖23) > [Flash settings] > [Flash exposure compensation].
- The correction level you specified is now displayed.



- When there is a risk of overexposure, the camera automatically adjusts the shutter speed or aperture value for flash shots to reduce washed-out highlights and shoot at optimal exposure. However, you can deactivate automatic adjustment of the shutter speed and aperture value by choosing [📷] menu (📖23) > [Flash settings] > [Safety FE] > [Off].

Shooting with FE Lock

► Still Images ► Movies

Retain the flash output level.



1 Raise the flash and set it to [📷] or [📷] (📖61).

2 Record the flash output level.

- Aim the camera at the subject to shoot with the exposure locked. With the shutter button pressed halfway, press the ▲ button.
- The flash fires, a circle is displayed showing the metering range, and [📷] is displayed, indicating that the flash output level has been retained.

3 Compose the shot and shoot.



- FE: Flash Exposure

Before Use

Basic Guide

Advanced Guide

Camera Basics

Auto Mode /
Hybrid Auto Mode

Other Shooting Modes

P Mode

Tv, Av, and M Mode

Playback

Wireless Features

Setting Menu

Accessories

Appendix

Index



Other Settings

Changing the IS Mode Settings

► Still Images ► Movies

You can keep image stabilization off until the moment you shoot.

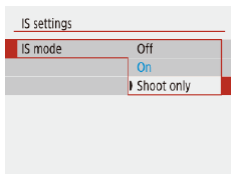

- Choose [MENU] menu (23) > [IS settings] > [IS mode] > [Shoot only].



- If image stabilization cannot prevent camera shake, mount the camera on a tripod or take other measures to hold it still. In this case, set [IS mode] to [Off].
- The setting is changed to [On] for movie recording.

Before Use

Basic Guide

Advanced Guide

Camera Basics

Auto Mode /
Hybrid Auto Mode

Other Shooting Modes

P Mode

Tv, Av, and M Mode

Playback

Wireless Features

Setting Menu

Accessories

Appendix

Index

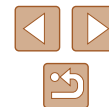

Tv, Av, and M Mode

Take smarter, more sophisticated shots, and customize the camera for your shooting style

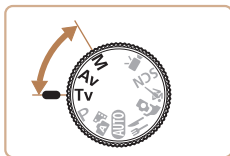

- Instructions in this chapter apply to the camera as set to the respective mode.

Specific Shutter Speeds (Tv Mode)

► Still Images ► Movies

Set your preferred shutter speed before shooting as follows. The camera automatically adjusts the aperture value to suit your shutter speed.

1 Enter Tv mode.

2 Set the shutter speed.

- Turn the  dial to set the shutter speed.



- In conditions requiring slower shutter speeds, there may be a delay before you can shoot again, as the camera processes images to reduce noise.
- When shooting at low shutter speeds on a tripod, you should set [IS mode] to [Off] (p.36).
- Maximum shutter speed with the flash is 1/2000 second. If you specify a faster speed, the camera will automatically reset the speed to 1/2000 second before shooting.
- With shutter speeds of 1.3 seconds or slower, ISO speed is [100] and cannot be changed.
- Standard exposure is not available if the aperture value blinks in white when you press the shutter button halfway. Adjust the shutter speed until the aperture value is displayed in white.



- **Tv**: Time value

Before Use

Basic Guide

Advanced Guide

Camera Basics

Auto Mode /
Hybrid Auto Mode

Other Shooting Modes

P Mode

Tv, Av, and M Mode

Playback

Wireless Features

Setting Menu

Accessories

Appendix

Index



Specific Aperture Values (Av Mode)

► Still Images ► Movies

Set your preferred aperture value before shooting as follows. The camera automatically adjusts the shutter speed to suit your aperture value.

1 Enter **Av** mode.



2 Set the aperture value.

- Turn the  dial to set the aperture value.



- Standard exposure is not available if the shutter speed blinks in white when you press the shutter button halfway. Adjust the aperture value until the shutter speed is displayed in white.



- **Av**: Aperture value (size of the opening made by the diaphragm in the lens)
- To automatically adjust the shutter speed and aperture value and enable standard exposure in **Tv/Av** modes even under unfavorable exposure conditions, choose  menu (p.23) > [Safety shift] > [Enable].

Specific Shutter Speeds and Aperture Values (M Mode)



► Still Images ► Movies

Follow these steps before shooting to set your preferred shutter speed and aperture value to obtain the desired exposure.

1 Enter **M** mode.

2 Set the ISO speed (p.53).

3 Configure the setting.

- Press the  button to choose shutter speed (1) or aperture value (2), and turn the  dial to specify a value.



(1) (2)



- With shutter speeds of 1.3 seconds or slower, ISO speed is [100] and cannot be changed.
-  Auto mode is not available in **M** mode.

Before Use

Basic Guide

Advanced Guide

Camera Basics

Auto Mode /
Hybrid Auto Mode

Other Shooting Modes

P Mode

Tv, Av, and M Mode

Playback

Wireless Features

Setting Menu

Accessories

Appendix

Index





- **M**: Manual
- Calculation of standard exposure is based on the specified metering method (📖52).
- When the ISO speed is fixed, you can compare your specified value (indicated by the position where the exposure level mark moves) to the standard exposure level by pressing the shutter button halfway. The exposure level mark is shown as [◀] or [▶] when the difference from standard exposure exceeds 3 stops.
- After you set the shutter speed and aperture value, the exposure level may change if you adjust the zoom or recompose the shot.
- When the ISO speed is fixed, screen brightness may change depending on your specified shutter speed and aperture value. However, screen brightness remains the same when the flash is up and the mode is set to [📷].
- Exposure may not be as expected when the ISO speed is set to [AUTO], because the ISO speed is adjusted to ensure standard exposure relative to your specified shutter speed and aperture value.
- Image brightness may be affected by Auto Lighting Optimizer. To keep the Auto Lighting Optimizer disabled in **M** mode, add a [✓] mark to [Disable during man expo] on the Auto Lighting Optimizer setting screen.
- To adjust exposure when ISO speed is set to [AUTO], select a level on the exposure compensation bar.

Adjusting the Flash Output

▶ Still Images ▶ Movies

Choose from the three flash levels in **Tv/Av/M** modes.

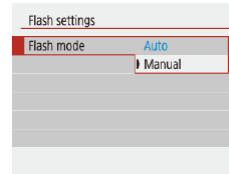

1 Enter Tv/Av/M mode.

2 Configure the setting.

- Choose [📷] menu (📖23) > [Flash settings] > [Flash mode] > [Manual] and configure [Flash output].

Before Use

Basic Guide

Advanced Guide

Camera Basics

Auto Mode /
Hybrid Auto Mode

Other Shooting Modes

P Mode

Tv, Av, and M Mode

Playback

Wireless Features

Setting Menu

Accessories

Appendix

Index

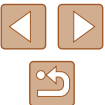

Playback

Have fun reviewing your shots, and browse or edit them in many ways

- To prepare the camera for these operations, press the  button to switch to playback.



- It may not be possible to play back or edit images that were renamed or already edited on a computer, or images from other cameras.

Viewing

► Still Images ► Movies

After shooting images or movies, you can view them on the screen as follows.

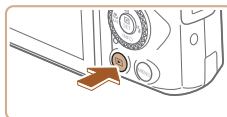







1 Switch to playback.



- Press the  button.



2 Choose images.

- To view the previous image, press the  button or turn the  dial counterclockwise. To view the next image, press the  button or turn the  dial clockwise.
- Press and hold the  /  buttons to browse through images quickly.



- Movies are identified by a **[SET]**  icon. Press the  button.

Before Use

Basic Guide

Advanced Guide

Camera Basics

Auto Mode /
Hybrid Auto Mode

Other Shooting Modes

P Mode

Tv, Av, and M Mode

Playback

Wireless Features

Setting Menu

Accessories

Appendix

Index

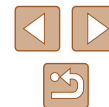

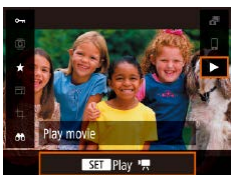

3 Play movies.

- Choose [▶] and press the [⊕] button.
- To adjust the volume, press the ▲/▼ buttons during playback.
- To pause or resume playback, press the [⏸] button.
- After the movie is finished, [SET] [▶] is displayed.



- To switch to a shooting mode from playback, press the shutter button halfway.
- To have the most recent shot displayed when you switch to playback, choose [▶] menu ([▶] 23) > [View from last seen] > [Disable], which will display the most recent shot when you start playback after turning the camera on.

Switching Display Modes

▶ Still Images ▶ Movies

Press the ▼ button to view other information on the screen, or to hide the information. For details on the information displayed, see “Playback (Detailed Information Display)” (▶ 120).

	No Information Display
	Simple Information Display
	Detailed Information Display
	Detailed Information Display 2

Before Use

Basic Guide

Advanced Guide

Camera Basics

Auto Mode /
Hybrid Auto Mode

Other Shooting Modes

P Mode

Tv, Av, and M Mode

Playback

Wireless Features

Setting Menu

Accessories

Appendix

Index



Overexposure Warning (for Image Highlights)

▶ Still Images ▶ Movies

Washed-out highlights in the image flash on the screen in detailed information display (📖68).

Histogram

▶ Still Images ▶ Movies

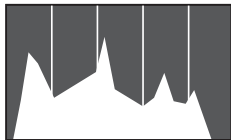

- The graph in detailed information display (📖68) is a histogram showing the distribution of brightness in the image. The horizontal axis represents the degree of brightness, and the vertical axis, how much of the image is at each level of brightness. Viewing the histogram is a way to check exposure.

GPS Information Display

▶ Still Images ▶ Movies

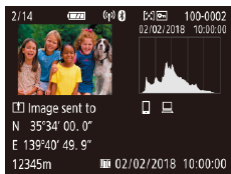

- Still images and movies you shoot can be geotagged using GPS information (such as latitude, longitude, and elevation) from a Bluetooth enabled smartphone (📖87). You can review this information in the GPS information display.
- Latitude, longitude, elevation, and UTC (shooting date and time) are listed from top to bottom.



- GPS information display is not available for images that lack this information.
- [---] is shown instead of numerical values for items not available on your smartphone or items not recorded correctly.



- UTC: Coordinated Universal Time, essentially the same as Greenwich Mean Time

Record of Sent Images

Images you have sent to a smartphone or computer are labeled with an icon of that device.

Viewing Short Movies Created When Shooting Still Images (Digest Movies)

▶ Still Images ▶ Movies

View digest movies recorded automatically in mode (📖28) on a day of still image shooting as follows.



1 Choose an image.

- Choose a still image labeled with .

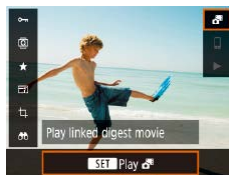

2 Play the digest movie.

- On the Quick Control screen (📖23), choose .
- The digest movie recorded automatically on the day of still image shooting is played back from the beginning.



- After a moment, will no longer be displayed when you are using the camera with information display deactivated (📖68).

Before Use

Basic Guide

Advanced Guide

Camera Basics

Auto Mode /
Hybrid Auto Mode

Other Shooting Modes

P Mode

Tv, Av, and M Mode

Playback

Wireless Features

Setting Menu

Accessories

Appendix

Index



Browsing and Filtering Images

Navigating through Images in an Index

► Still Images ► Movies

By displaying multiple images in an index, you can quickly find the images you are looking for.

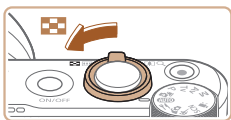

1 Display images in an index.

- Move the zoom lever toward to display images in an index. Moving the lever again will increase the number of images shown.
- To display fewer images, move the zoom lever toward . Fewer images are shown each time you move the lever.



2 Choose an image.

- Turn the dial or press the buttons to choose an image.
- An orange frame is displayed around the selected image.
- Press the button to view the selected image in single-image display.

Finding Images Matching Specified Conditions

► Still Images ► Movies

Find desired images quickly on a memory card full of images by filtering image display according to your specified conditions. You can also protect or erase these images all at once.

★ Rating	Displays images you have rated.
📅 Date	Displays the images shot on a specific date.
📁 Folder	Displays images in a specific folder.
🔑 Protect	Displays protected or unprotected images on the memory card.
📁 Type of file	Displays [Stills], [Movies], or movies shot in [mode].

1 Choose a search condition.

- On the Quick Control screen (23), choose [].
- Press the buttons to navigate and the buttons to choose an option.
- When finished, press the **MENU** button.

2 View the filtered images.

- Images matching your conditions are displayed in yellow frames. To view only these images, press the buttons, or turn the dial.
- To cancel filtered display, choose [] in step 1 and press the button.



- When the camera has found no corresponding images for some conditions, those conditions will not be available.

Before Use

Basic Guide

Advanced Guide

Camera Basics

Auto Mode /
Hybrid Auto Mode

Other Shooting Modes

P Mode

Tv, Av, and M Mode

Playback

Wireless Features

Setting Menu

Accessories

Appendix

Index





- To clear your search, press the button on the setting screen.
- You can also protect, rate, or apply other actions only to all matching images, which are displayed in yellow frames, by pressing the button.
- If you edit images and save them as new images, a message is displayed, and the images that were found are no longer shown.
- The same operations are available by choosing [] menu > [Set image search conditions].

Image Viewing Options

Magnifying Images

▶ Still Images ▶ Movies

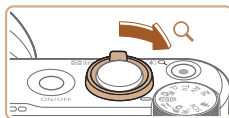

(1)

1 Magnify an image.

- Moving the zoom lever toward will zoom in and magnify the image. You can magnify images up to about 10x by continuing to hold the zoom lever.
- The approximate position of the displayed area (1) is shown for reference.
- To zoom out, move the zoom lever toward . You can return to single-image display by continuing to hold it.

2 Move the display position and switch images as needed.

- To move the display position, press the / / / buttons.
- To switch to other images while zoomed, turn the dial.

Before Use

Basic Guide

Advanced Guide

Camera Basics

Auto Mode /
Hybrid Auto Mode

Other Shooting Modes

P Mode

Tv, Av, and M Mode

Playback

Wireless Features

Setting Menu

Accessories

Appendix

Index



Viewing Slideshows

▶ Still Images ▶ Movies

Automatically play back images from a memory card as follows.

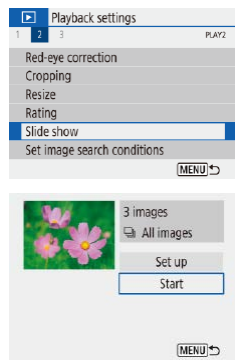

- Choose [▶] menu (📖23) > [Slide show].
- To start the slideshow, choose [Start].
- You can configure display time per image, slideshow repetition, and the transition between images by choosing [Set up].
- Press the **MENU** button to stop the slideshow.



- The camera's power-saving functions (📖101) are deactivated during slideshows.



- To pause or resume slideshows, press the ⏸ button.
- You can switch to other images during playback by pressing the ◀▶ buttons or turning the 🌀 dial. For fast-forward or fast-rewind, hold the ◀▶ buttons down.
- In filtered display (📖70), only images matching search conditions are played.

Protecting Images

▶ Still Images ▶ Movies

Protect important images to prevent accidental erasure (📖74).



- On the Quick Control screen (📖23), choose [🔑] > [Enable].
- After protection is applied, [🔒] is displayed.
- To cancel protection, repeat this process and choose [Disable].



- Protected images on a memory card will be erased if you format the card (📖102).



- Protected images cannot be erased using the camera's erasure function. To erase them this way, first cancel protection.

Protecting Multiple Images

You can choose multiple images to protect at once.

Choosing a Selection Method

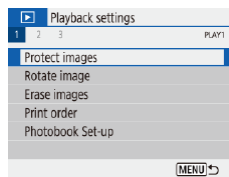

1 Access the setting screen.

- Choose [▶] menu (📖23) > [Protect images].

Before Use

Basic Guide

Advanced Guide

Camera Basics

Auto Mode /
Hybrid Auto Mode

Other Shooting Modes

P Mode

Tv, Av, and M Mode

Playback

Wireless Features

Setting Menu

Accessories

Appendix

Index



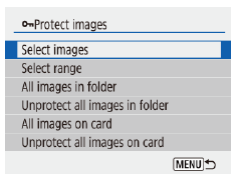

2 Choose a selection method.

- Choose the desired item.

Choosing Images Individually

1 Choose [Select images].

- Choose [] menu (23) > [Protect images] > [Select images].

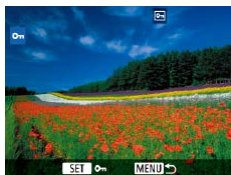

2 Choose an image.

- [On] is displayed after you choose an image and press the button.
- To cancel selection, press the button. [On] is no longer displayed.
- Repeat this process to specify other images.

Selecting a Range

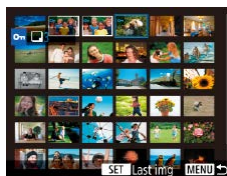
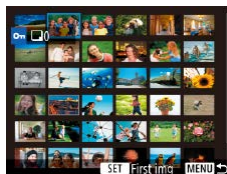

1 Choose [Select range].

- Choose [] menu (23) > [Protect images] > [Select range].

2 Choose a starting image.

- Choose an image and press the button.

3 Choose an ending image.

- Choose an image and press the button.
- Images in the specified range are now protected.

Before Use
Basic Guide
Advanced Guide
Camera Basics
Auto Mode / Hybrid Auto Mode
Other Shooting Modes
P Mode
Tv, Av, and M Mode
Playback
Wireless Features
Setting Menu
Accessories
Appendix
Index



Specifying All Images at Once

1 Choose [All images in folder] or [All images on card].

- Choose [] menu (📖23) > [Protect images].
- Choose [All images in folder] to protect all images in a folder, or choose [All images on card] to protect all images on a memory card.

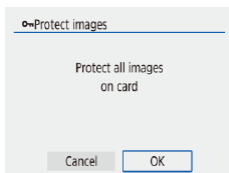

2 Protect the images.

- When choosing [All images in folder], choose the folder and protect the images.



- To clear protection from all images at once, choose [Unprotect all images in folder] or [Unprotect all images on card].

Erasing Images

▶ Still Images ▶ Movies

You can choose and erase unneeded images one by one. Be careful when erasing images, because they cannot be recovered. However, protected images (📖72) cannot be erased.

1 Choose an image to erase.

2 Erase the image.

- Press the  button.
- The current image is now erased by choosing [Erase].

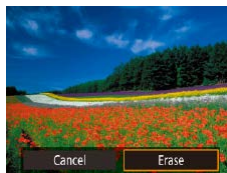

Erasing Multiple Images at Once

You can choose multiple images to erase at once. Be careful when erasing images, because they cannot be recovered. However, protected images (📖72) cannot be erased.

Choosing a Selection Method

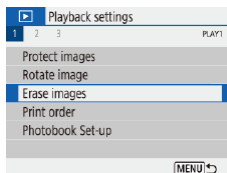

1 Access the setting screen.

- Choose [] menu (📖23) > [Erase images].

Before Use

Basic Guide

Advanced Guide

Camera Basics

Auto Mode /
Hybrid Auto Mode

Other Shooting Modes

P Mode

Tv, Av, and M Mode

Playback

Wireless Features

Setting Menu

Accessories

Appendix

Index



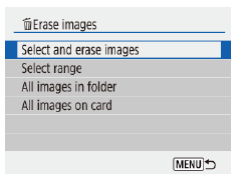

2 Choose a selection method.

- Choose the desired item.

Choosing Images Individually

1 Choose [Select and erase images].

- Choose [] menu (23) > [Erase images] > [Select and erase images].



2 Choose an image.

- [✓] is displayed after you choose an image and press the button.
- To cancel selection, press the button again. [✓] is no longer displayed.
- Repeat this process to specify other images.

3 Erase the images.

- Press the MENU button to choose [OK].

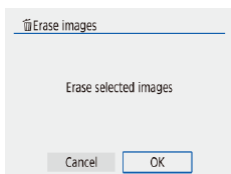

Selecting a Range

1 Choose [Select range].

- Choose [] menu (23) > [Erase images] > [Select range].

2 Choose images.

- Follow steps 2 – 3 in “Selecting a Range” (73) to specify images.

3 Erase the images.

- Press the MENU button to choose [OK].

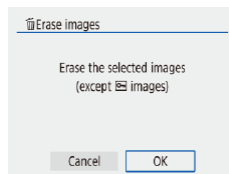

Before Use

Basic Guide

Advanced Guide

Camera Basics

Auto Mode /
Hybrid Auto Mode

Other Shooting Modes

P Mode

Tv, Av, and M Mode

Playback

Wireless Features

Setting Menu

Accessories

Appendix

Index

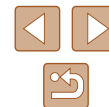

Specifying All Images at Once

1 Choose [All images in folder] or [All images on card].

- Choose [] menu (23) > [Erase images].
- Choose [All images in folder] to erase all images in a folder, or choose [All images on card] to erase all images on a memory card.

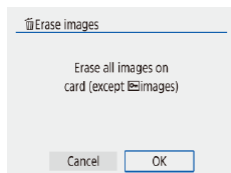

2 Erase the images.

- When choosing [All images in folder], choose the folder and erase the images.

Rotating Images

► Still Images ► Movies

Change the orientation of images and save them as follows.



- On the Quick Control screen (23), choose [], and then choose a direction for rotation.
- Choose [] to rotate the image 90° left or [] to rotate it 90° right.



- Images are not rotated when [Auto rotate] in the [] menu (23) is set to [Off].

Before Use

Basic Guide

Advanced Guide

Camera Basics

Auto Mode / Hybrid Auto Mode

Other Shooting Modes

P Mode

Tv, Av, and M Mode

Playback

Wireless Features

Setting Menu

Accessories

Appendix

Index

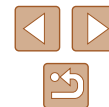

Rating Images

► Still Images ► Movies

Organize images by rating them on a scale of 1 – 5. By viewing only images with a specified rating, you can restrict the following operations to all images with that rating.

- “Viewing” (📖67), “Viewing Slideshows” (📖72), “Protecting Images” (📖72), “Erasing Images” (📖74), “Adding Images to the Print Orders (DPOF)” (📖113), “Adding Images to a Photobook” (📖115)



- On the Quick Control screen (📖23), choose [★], and then choose a rating.
- To cancel the rating, repeat this process and choose [OFF].

Editing Still Images



- Image editing (📖77 – 📖79) is only available when the memory card has sufficient free space.

Resizing Images

► Still Images ► Movies

Save a copy of images at a lower number of recording pixels.



- On the Quick Control screen (📖23), choose [📐] and the size.



- Editing is not possible for images shot at a recording pixel setting of [S] (📖35).



- Images cannot be resized to a higher number of recording pixels.

Before Use

Basic Guide

Advanced Guide

Camera Basics

Auto Mode /
Hybrid Auto Mode

Other Shooting Modes

P Mode

Tv, Av, and M Mode

Playback

Wireless Features

Setting Menu

Accessories

Appendix

Index

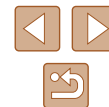

Cropping

► Still Images ► Movies

You can specify a portion of an image to save as a separate image file.



1 Choose [Cropping].

- On the Quick Control screen (23), choose [C].

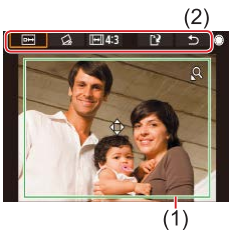

2 Adjust the cropping area.

- A frame is displayed around the portion of the image to be cropped (1).
- To resize the frame, move the zoom lever.
- To move the frame, press the ▲/▼/◀/▶ buttons.
- To move among the items at the top of the screen (2), turn the dial.
- To straighten the image, choose [L].
- To change the aspect ratio, choose [A].

3 Check the edited image.

- Choose [R] to display the cropped image.
- To cancel editing, choose [C].



4 Save the new image.

- Choose [R].
- The image is now saved as a new file.



- Cropped images will have a lower number of recording pixels than uncropped images.

Before Use

Basic Guide

Advanced Guide

Camera Basics

Auto Mode /
Hybrid Auto Mode

Other Shooting Modes

P Mode

Tv, Av, and M Mode

Playback

Wireless Features

Setting Menu

Accessories

Appendix

Index

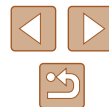

Correcting Red-Eye

► Still Images ► Movies

Automatically corrects images affected by red-eye. You can save the corrected image as a separate file.

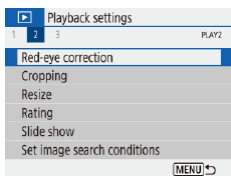

1 Choose [Red-eye correction].

- Choose [] menu (23) > [Red-eye correction].

2 Choose an image.

3 Correct the image.

- Press the [] button.
- Red-eye detected by the camera is now corrected, and frames are displayed around corrected image areas.
- Enlarge or reduce images as needed. Follow the steps in “Magnifying Images” (71).

4 Save the new image.

- The image is now saved as a new file.

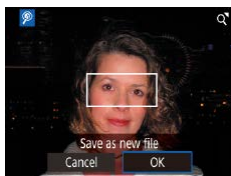

- Some images may not be corrected accurately.

Editing Movies

► Still Images ► Movies

Removing the Beginning/End of Movies

You can remove unneeded portions from the beginning and end of movies (except digest movies (28) and video snapshots (50)).

1 Choose a movie.

2 Play the movie.

- On the Quick Control screen (23), choose [].

3 Choose [].

- Press the [] button during movie playback to display the movie control panel, and then choose [].
- The movie editing panel and editing bar are now displayed.

4 Specify portions to cut.

- (1) is the movie editing panel, and (2) is the editing bar.
- Choose [] or [].
- To view the portions you can cut (identified by [] on the screen), press the [] buttons or turn the [] dial to move []. At the position to cut, press the [] button.
- If you move [] to a position other than a [] mark, in [] the portion before the nearest [] mark on the left will be cut, while in [] the portion after the nearest [] mark on the right will be cut.

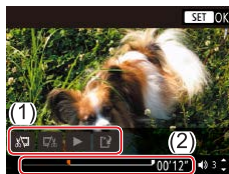
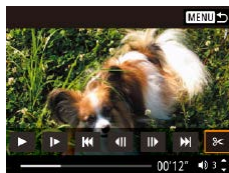

Before Use

Basic Guide

Advanced Guide

Camera Basics

Auto Mode /
Hybrid Auto Mode

Other Shooting Modes

P Mode

Tv, Av, and M Mode

Playback

Wireless Features

Setting Menu

Accessories

Appendix

Index



5 Review the edited movie.

- Choose [▶] to play the edited movie.
- To edit the movie again, repeat step 4.
- To cancel editing, press the **MENU** button.

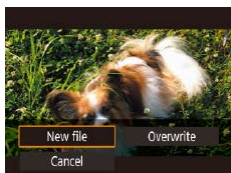

6 Save the edited movie.

- Choose [L] and then [New file].

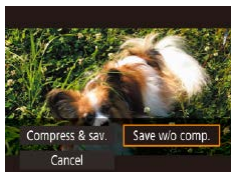

- Choose [Save w/o comp.].
- The movie is now saved as a new file.



- To overwrite the original movie with the cut one, choose [Overwrite] in step 6. In this case, the original movie will be erased.
- If the memory card lacks sufficient space, only [Overwrite] will be available.
- Movies may not be saved if the battery pack runs out while saving is in progress.
- When editing movies, you should use a fully charged battery pack.

Extracting Frames of 4K Movies as Stills

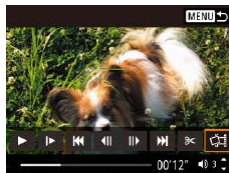

- You can save a frame of a movie as a still image by choosing [S] in the movie control panel in step 3 of “Removing the Beginning/End of Movies” (79).

Reducing File Sizes

Movie file sizes can be reduced by compressing movies as follows.

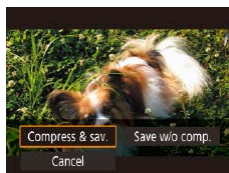

- On the screen in step 4 of “Removing the Beginning/End of Movies” (79), choose [L], and then choose [New file].
- Choose [Compress & sav.].

Before Compression			After Compression		
4K 29.97P	FHD 59.94P	FHD 29.97P	FHD 29.97P		
4K 25.00P	FHD 50.00P	FHD 25.00P	FHD 25.00P		
FHD 59.94P			FHD 29.97P		
FHD 50.00P			FHD 25.00P		



- Edited movies cannot be saved in compressed format when you choose [Overwrite].

Before Use

Basic Guide

Advanced Guide

Camera Basics

Auto Mode /
Hybrid Auto Mode

Other Shooting Modes

P Mode

Tv, Av, and M Mode

Playback

Wireless Features

Setting Menu

Accessories

Appendix

Index



Editing Digest Movies

► Still Images ► Movies

Individual chapters (clips) (📖28) recorded in  mode can be erased, as needed. Be careful when erasing clips, because they cannot be recovered.



1 Choose an image.

- Choose a still image labeled with **[SET]** .

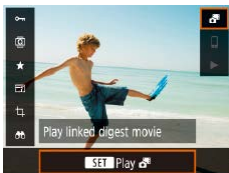





2 Play the digest movie.

- On the Quick Control screen (📖23), choose .
- The digest movie recorded automatically on the day of still image shooting is played back from the beginning.



3 Select the clip to erase.

- Press the  button to display the movie control panel.
- Choose  or  and press the  button to choose a clip.



4 Choose .

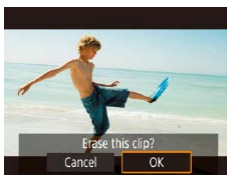

5 Confirm erasure.

- The clip is erased, and the short movie is overwritten.



- Albums created when recording video snapshots can also be edited. Albums created with  > [Create album] cannot be edited.

Before Use
Basic Guide
Advanced Guide
Camera Basics
Auto Mode / Hybrid Auto Mode
Other Shooting Modes
P Mode
Tv, Av, and M Mode
Playback
Wireless Features
Setting Menu
Accessories
Appendix
Index

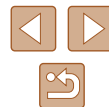

Combining Video Snapshots

▶ Still Images ▶ Movies

Combine video snapshots to create a new movie (album).

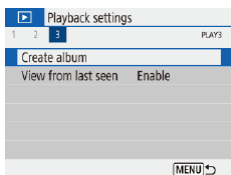

1 Access the editing screen.

- Choose [▶] menu (23) > [Create album].



2 Specify video snapshots.

- Choose a movie (an existing album) and press the [⊕] button.
- When finished, press the MENU button to exit movie selection.

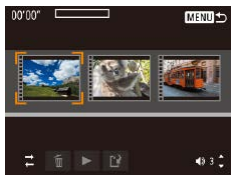

3 Edit the album.

- Video snapshots in the movie selected in step 2 are displayed.
- Choose an item in the editing menu at the bottom and press the [⊕] button.
- Along the top of the screen, choose video snapshots to edit, and edit them as needed.

[↔] Rearrange video snapshots	Rearrange video snapshots. Choose a video snapshot to move and press the [⊕] button. To move it, use the [◀/▶] buttons.
[⊖] Remove video snapshot	Choose video snapshots to exclude from the new album. Video snapshots labeled with a [⊖] icon are not included in the new album, but they are not deleted from the original album.
[▶] Play video snapshot	Play the selected video snapshot.
[⏏] Finish editing	Exit album editing.

4 Exit editing.

- Press the MENU button to return to the editing menu and choose [⏏] to exit editing.

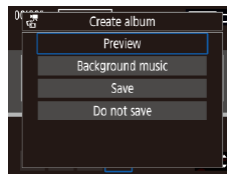

5 Save the album.

- Choose [Save].
- To add background music, choose [Background music].
- Choose [Preview] to preview the album you edited.
- After the album is saved, the playback screen is displayed.



- Albums created with [Create album] cannot be edited.

Before Use
Basic Guide
Advanced Guide
Camera Basics
Auto Mode / Hybrid Auto Mode
Other Shooting Modes
P Mode
Tv, Av, and M Mode
Playback
Wireless Features
Setting Menu
Accessories
Appendix
Index



Wireless Features

Send images wirelessly from the camera to a variety of compatible devices, and use the camera with Web services



- Before using wireless features, be sure to read “Precautions for Wireless Features” (p.127).

Available Wireless Features

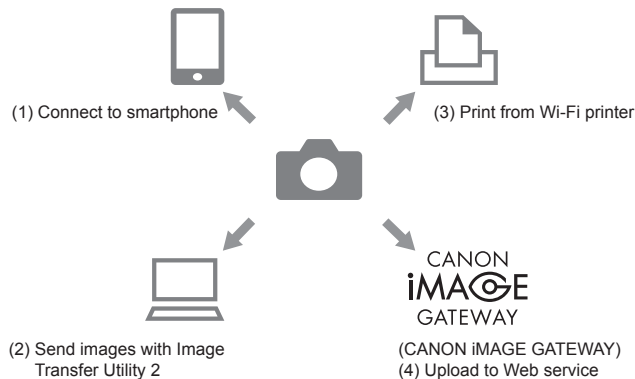

- (1) Connect to smartphone (pp.85, pp.88)
Control the camera remotely and browse images on the camera over a Wi-Fi connection by using the dedicated Camera Connect app on smartphones or tablets.
You can also geotag images and use other features when connected by Bluetooth®*.
For convenience in this guide, smartphones, tablets, and other compatible devices are collectively referred to as “smartphones.”
* Bluetooth low energy technology (hereafter referred to as “Bluetooth”)
- (2) Send images with Image Transfer Utility 2 (p.91)
With Image Transfer Utility 2, images can be sent to a computer connected via Wi-Fi.

Before Use

Basic Guide

Advanced Guide

Camera Basics

Auto Mode /
Hybrid Auto Mode

Other Shooting Modes

P Mode

Tv, Av, and M Mode

Playback

Wireless Features





Setting Menu

Accessories

Appendix

Index



- (3)  Print from Wi-Fi printer  93
Print images over a Wi-Fi connection from printers compatible with PictBridge (wireless LAN) technology.
- (4)  Upload to Web service  94
Share images with friends or family on social media or the CANON iMAGE GATEWAY online photo service for Canon customers after you complete member registration (free of charge).

Preparing to Use Wireless Features

First, prepare to use wireless features.

Preparing the Camera

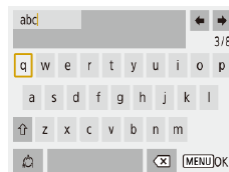
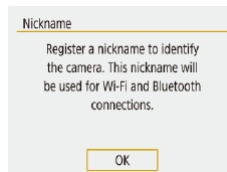

1 Press the (Wi-Fi) button.

- If the wireless settings screen is not displayed initially when you press the (Wi-Fi) button, press the (Wi-Fi) button again.

2 Register [Nickname].

- To use the nickname displayed, press the **MENU** button.
- Choose [OK] on the next screen to return to the function settings menu.
- Nicknames are 1 – 8 characters and can be changed later.

Before Use

Basic Guide

Advanced Guide

Camera Basics

Auto Mode /
Hybrid Auto Mode

Other Shooting Modes

P Mode

Tv, Av, and M Mode

Playback

Wireless Features

Setting Menu

Accessories

Appendix

Index





- Wi-Fi and Bluetooth signal transmission can be turned off as follows.
 - Wi-Fi: Choose [Wi-Fi] menu (📖23) > [Wireless communication settings] > [Wi-Fi settings], and in [Wi-Fi], choose [Disable].
 - Bluetooth: Choose [Bluetooth] menu (📖23) > [Wireless communication settings] > [Bluetooth function], and in [Bluetooth function], choose [Disable].
- You can change the camera nickname in [Wi-Fi] menu (📖23) > [Wireless communication settings] > [Nickname].

Preparing Smartphones

- Before connecting to the camera, you must install the free dedicated Camera Connect app on the smartphone.
- For details on this application (supported smartphones and included functions), refer to the Canon website.
- Camera Connect can be installed from Google Play or the App Store. You can also access Google Play or the App Store from a QR code that you can display on the camera when registering the smartphone on the camera.
- Use the latest version of the smartphone OS.
- Activate Bluetooth and Wi-Fi on the smartphone.

Pairing with Smartphones via Bluetooth

Pair the camera with a Bluetooth enabled smartphone as follows.

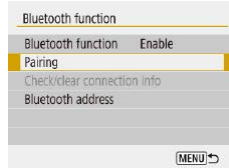
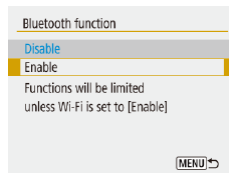
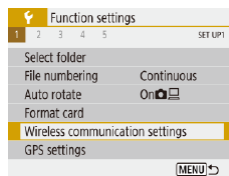

1 Choose [Wireless communication settings].

- Choose [Wi-Fi] menu (📖23) > [Wireless communication settings].

2 Set Bluetooth to [Enable].

- Choose [Bluetooth function].
- Choose [Bluetooth function] again and then [Enable].

3 Pair the devices.

- Choose [Pairing] > [Do not display].
- A message is displayed indicating that pairing is in progress.
- Using the smartphone, pair the camera and smartphone as described in the next steps.

Before Use

Basic Guide

Advanced Guide

Camera Basics

Auto Mode /
Hybrid Auto Mode

Other Shooting Modes

P Mode

Tv, Av, and M Mode

Playback

Wireless Features

Setting Menu

Accessories

Appendix

Index





4 Start Camera Connect on the smartphone.

5 Choose the camera to pair with.

- Touch the nickname of the camera to pair with.
- In Android, go to step 7.

6 Touch [Pair] (iOS only).

7 On the camera, complete the pairing process.

- Choose [OK] when a pairing confirmation message is displayed.
- On the pairing notification screen, press the  button.
- Pairing is now complete, and the camera is connected to the smartphone via Bluetooth.



- Any active Bluetooth connections will be lost if you remove the camera battery pack. The connection will be reestablished when you insert the battery pack and turn on the camera.

[Bluetooth function] Screen

Bluetooth function

- Choose [Enable] when using a Bluetooth connection with a smartphone.

Pairing

- Pair the camera with a smartphone.

Check/clear connection info

- Enables you to check the name and connection status of paired devices.
- Before pairing with another smartphone, clear the connection information for the device currently paired via Bluetooth (99).



Bluetooth address

- Enables you to check the camera's Bluetooth address.

Controlling the Camera from a Smartphone

- In Camera Connect, choose [Bluetooth remote controller].
- Control the camera remotely or browse images as you watch a simulated camera screen.



- Battery life may be shorter when you use the camera after pairing, because power is consumed even when the camera is off.
- Before bringing the camera where use of electronic devices is restricted, disable Bluetooth communication even when it is off by choosing  menu (23) > [Wireless communication settings] > [Bluetooth function] (twice) > [Disable].

Before Use
Basic Guide
Advanced Guide
Camera Basics
Auto Mode / Hybrid Auto Mode
Other Shooting Modes
P Mode
Tv, Av, and M Mode
Playback
Wireless Features
Setting Menu
Accessories
Appendix
Index

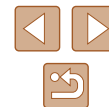

Geotagging Images as You Shoot

Your shots can be geotagged using GPS information (such as latitude, longitude, and elevation) from a smartphone connected via Bluetooth.



1 Start Camera Connect.

- Keep the smartphone running Camera Connect within arm's reach.



2 Turn on GPS.

- Choose [Y] menu (📖23) > [GPS settings].
- In [GPS via mobile], choose [Enable].
- On the smartphone, activate location services.

3 Shoot.

- Before shooting, confirm that [📶] and [GPS] icons are shown on the camera. If the icons are not shown, press the INFO button repeatedly.
- Your shots are now geotagged.
- From now on, shots you take with Camera Connect running will be geotagged.

Checking Location Information

- Switch to “Detailed Information Display 2” (📖68) to view GPS information in geotagged images.
- The date and time of UTC is essentially the same as Greenwich Mean Time.
- Using the Map Utility program, you can display the location information on a map.



- The GPS information added to your movie is acquired initially, when you start recording.
- Shots may not be geotagged immediately after the camera is turned on.
- Others may be able to locate or identify you by using location data in your geotagged still images or movies. Be careful when sharing these images with others, as when posting images online where many others can view them.

Before Use

Basic Guide

Advanced Guide

Camera Basics

Auto Mode /
Hybrid Auto Mode

Other Shooting Modes

P Mode

Tv, Av, and M Mode

Playback

Wireless Features

Setting Menu

Accessories

Appendix

Index



Connecting to Smartphones via Wi-Fi

Connect the camera to a smartphone via Wi-Fi in either of these ways. Turning off the camera will end the Wi-Fi connection.

Connecting to Bluetooth Connected Smartphones via Wi-Fi

You can connect via Wi-Fi as follows when the camera and smartphone are paired via Bluetooth.



1 Choose a Camera Connect function.

- Choose [Images on camera].
- In iOS, choose [Connect] when a message is displayed to confirm camera connection.

2 Confirm that the devices are connected via Wi-Fi.

- After the devices are connected via Wi-Fi, a screen for the selected function is displayed on the smartphone.
- [Wi-Fi on] is displayed on the camera.

Connecting to Smartphones via Wi-Fi with the Wi-Fi Button

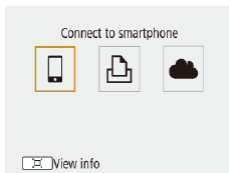

1 Press the (Wi-Fi) button.

- Choose [Wi-Fi].

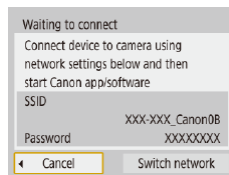
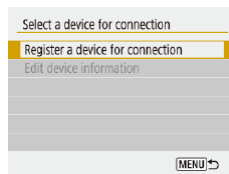

2 Choose [Register a device for connection].

- Choose [Register a device for connection], and then choose [Do not display].

3 Check the SSID and password.

- The SSID ends with _Canon0B.

4 Connect the smartphone to the camera.

- In the smartphone's Wi-Fi setting menu, choose the SSID (network name) displayed on the camera to establish a connection.
- In the password field on the smartphone, enter the password displayed on the camera.

5 Start Camera Connect.

- After [Start Canon app/software on the smartphone] is displayed on the camera, Camera Connect starts up on the smartphone.

6 Select the camera to connect to.

- In the [Cameras] list in Camera Connect, touch the camera to connect to via Wi-Fi.

- Before Use
- Basic Guide
- Advanced Guide
 - Camera Basics
 - Auto Mode / Hybrid Auto Mode
 - Other Shooting Modes
 - P Mode
 - Tv, Av, and M Mode
 - Playback
 - Wireless Features
 - Setting Menu
 - Accessories
 - Appendix
- Index

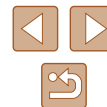

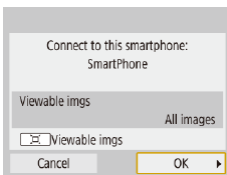

7 Establish a Wi-Fi connection.

- Choose [OK] and press the button.
- [Wi-Fi on] is displayed on the camera.
- The main Camera Connect screen is displayed on the smartphone.
- The devices are now connected via Wi-Fi.

Establishing a Connection via an Access Point

The camera and smartphone can also be connected via an access point. First, connect the smartphone to the access point. Connect the devices near the access point, because you will need to press the WPS button.

1 Choose [WPS (PBC mode)].

- Choose [] menu (📖23) > [Wireless communication settings] > [Wi-Fi function] > .
- Choose [Register a device for connection], and then choose [Do not display].
- Choose [Switch network] on the [Waiting to connect] screen.
- Choose [Connect with WPS], and then choose [WPS (PBC mode)].

2 Press the WPS button on the access point.

3 Choose [Auto setting] on the camera's [IP address set.] screen.

- Connection is now attempted between the camera and access point.

4 After a connection is established, go to step 5 in “Connecting to Smartphones via Wi-Fi with the Wi-Fi Button” (📖88).



- If you chose [WPS (PIN mode)] in step 1, a PIN code will be displayed on the screen. Be sure to set this code in the access point. Choose a device in the [Select a device for connection] screen. For further details, refer to the user manual included with your access point.

Controlling the Camera from a Smartphone

Use Camera Connect to browse images on the camera or shoot remotely.

Images on camera

Browse images on the camera and save them to the smartphone.

Remote live view shooting

Shoot remotely as you view a live image from the camera on the smartphone.



- If the camera temporarily overheats during extended 4K recording or full HD recording at a high frame rate, is displayed and recording stops. At this time, movie recording will be unavailable, even if you press the movie button. Following the instructions displayed, either choose a movie recording size other than , , or or turn off the camera to let it cool down before you resume recording.

Before Use

Basic Guide

Advanced Guide

Camera Basics

Auto Mode /
Hybrid Auto Mode

Other Shooting Modes

P Mode

Tv, Av, and M Mode

Playback

Wireless Features

Setting Menu

Accessories

Appendix

Index



Sending Images to a Smartphone

Images can be sent from the camera to a smartphone connected via Wi-Fi.

■ Sending Images to a Smartphone from the Camera Menu



1 Access the menu.

- Choose [F] menu (📖23) > [Wireless communication settings] > [Send images to smartphone].
- Images are displayed.

2 Choose an image.

- Choose an image and press the [G] button.
- After you choose other sending options on the screen displayed, the image is sent to the smartphone.

■ Sending Images to a Smartphone During Playback



1 Play back images.

2 Press the [G] button.

3 Choose [📱].

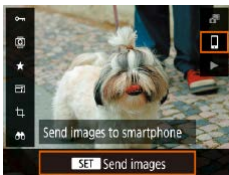

4 Choose an image.

- Choose an image and press the [G] button.
- After you choose other sending options on the screen displayed, the image is sent to the smartphone.

■ Sending Images to a Smartphone Automatically as You Shoot

Your shots can be automatically sent to a smartphone.



1 Choose [Send to smartphone after shot].

- Choose [F] menu (📖23) > [Wireless communication settings] > [Wi-Fi settings] > [Send to smartphone after shot].

2 Set up automatic sending.

- Choose [Auto send], and then choose [Enable].
- Choose a size in [Size to send].

3 Shoot.

- Your shots are sent to the smartphone.

■ Specifying Viewable Images

Restrict the images that can be sent to the smartphone or browsed from the smartphone.

1 End the Wi-Fi connection (📖91).

Before Use
Basic Guide
Advanced Guide
Camera Basics
Auto Mode / Hybrid Auto Mode
Other Shooting Modes
P Mode
Tv, Av, and M Mode
Playback
Wireless Features
Setting Menu
Accessories
Appendix
Index



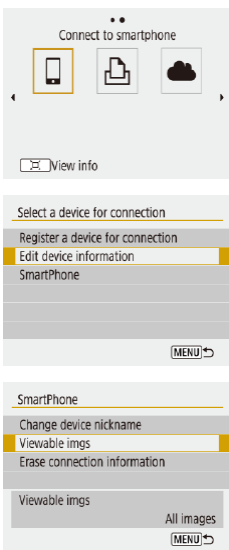

2 Press the (P) button.

- Choose [P].

3 Choose [Edit device information].

- Choose a smartphone.

4 Choose [Viewable imgs].

- Specify which images can be viewed.



- Remote live view shooting in Camera Connect is not possible unless [Viewable imgs] is set to [All images].

Ending Wi-Fi Connections

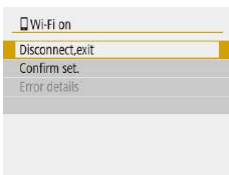

- Choose [P] menu (23) > [Wireless communication settings] > [Wi-Fi function] > [Disconnect.exit].
- You can also disconnect by touching [x] on the Camera Connect screen.

Sending Images to a Computer Automatically

Images on the camera can be automatically sent to a computer connected to an access point (also set up for camera Wi-Fi connections) when the camera is within range, as when you bring the camera home after shooting.

Connecting via Wi-Fi



1 Connect the computer to the access point.

- Install Image Transfer Utility 2 on the computer.

2 Start Image Transfer Utility 2.

3 In Image Transfer Utility 2, access the pairing settings screen.

- The screen to set up pairing is shown when you follow the instructions displayed the first time Image Transfer Utility 2 starts up.

4 Choose the type of connection.

- Choose [P] menu (23) > [Wireless communication settings] > [Wi-Fi settings] > [Auto send images to computer].
- Choose [Auto send] > [Enable], and then choose [OK].
- Choose [Connect with WPS], and then choose [WPS (PBC mode)].



Before Use
Basic Guide
Advanced Guide
Camera Basics
Auto Mode / Hybrid Auto Mode
Other Shooting Modes
P Mode
Tv, Av, and M Mode
Playback
Wireless Features
Setting Menu
Accessories
Appendix
Index

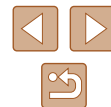



5 Press the WPS button.

- Press the WPS button on the access point to allow the camera to connect.



6 Choose automatic setup.

- The [IP address set.] screen is displayed. Choose [Auto setting].



7 Choose a computer.

- Names of computers connected to the access point are listed. Choose a computer for auto image transfer.



8 On the computer, choose the camera for pairing.

- Camera nicknames are shown on the pairing screen in Image Transfer Utility 2.
- Choose the camera to connect to and click [Pairing] to connect the computer and camera.

Setting Up Auto Image Transfer



9 Specify the sending options.

- Choose [F] menu (23) > [Wireless communication settings] > [Wi-Fi settings] > [Auto send images to computer].
- In [Image sending options], specify the transfer conditions.
- Make sure the camera is off.

Sending Images Automatically

- Following the sending options in step 9, images on the camera are automatically sent to the computer you are logged in to when you bring the camera within range of the access point and turn the camera on.



- When using auto image transfer, ensure that the battery pack has sufficient charge. Power saving on the camera is deactivated.
- Any images captured after auto image transfer are not sent to the computer then. They are sent automatically when the camera is restarted.



- Auto image transfer to a computer is triggered by camera startup within range of the access point. If auto image transfer does not begin automatically, try restarting the camera.
- To stop sending images automatically, choose [Auto send images to computer] > [Auto send] > [Disable].

Before Use

Basic Guide

Advanced Guide

Camera Basics

Auto Mode / Hybrid Auto Mode

Other Shooting Modes

P Mode

Tv, Av, and M Mode

Playback

Wireless Features

Setting Menu

Accessories

Appendix

Index



Connecting to Printers via Wi-Fi

Images on the camera can be printed on a printer connected to the camera via Wi-Fi.

1 Press the  button.

2 Choose .

3 Choose [Register a device for connection].

4 Check the SSID and password.

- The SSID ends with _Canon0B.

5 Use the printer to connect to the camera via Wi-Fi.

- In the printer's Wi-Fi setting menu, choose the SSID (network name) displayed on the camera to establish a connection.

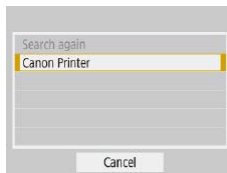
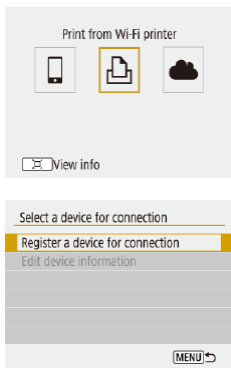



- In the password field on the printer, enter the password displayed on the camera.

6 Choose the printer to connect to via Wi-Fi.

- Choose the printer to use and press the  button.
- Images on the memory card are displayed after the devices are connected via Wi-Fi.

7 Choose an image to print.

- Choose an image and press the  button.
- Select or specify the items displayed, and then print ( 112).

Before Use

Basic Guide

Advanced Guide

Camera Basics

Auto Mode /
Hybrid Auto Mode

Other Shooting Modes

P Mode

Tv, Av, and M Mode

Playback

Wireless Features

Setting Menu

Accessories

Appendix

Index

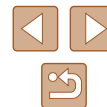

Establishing a Connection via an Access Point

The camera can connect to an access point that a printer is connected to, to print via the access point.

Connect the devices near the access point, because you will need to press the WPS button.

1 Choose [WPS (PBC mode)].

- Choose [F] menu (93) > [Wireless communication settings] > [Wi-Fi function] > [P].
- Choose [Register a device for connection], and on the [Waiting to connect] screen, choose [Switch network].
- Choose [Connect with WPS], and then choose [WPS (PBC mode)].

2 Press the WPS button on the access point.

3 Choose [Auto setting] on the camera's [IP address set.] screen.

- Connection is now attempted between the camera and access point.

4 After a connection is established, go to step 6 in "Connecting to Printers via Wi-Fi" (93).

Uploading Images to Web Services

Registering Web Services

Use a smartphone or computer to add your Web services to the camera.

- A smartphone or computer with a browser and Internet connection is required to complete camera settings for CANON iMAGE GATEWAY and other Web services.
- Check the CANON iMAGE GATEWAY website for details on browser (Microsoft Internet Explorer, etc.) requirements, including settings and version information.
- For information on countries and regions where CANON iMAGE GATEWAY is available, visit the Canon website (<http://www.canon.com/cig/>).
- For CANON iMAGE GATEWAY instructions and setting details, refer to the help information for CANON iMAGE GATEWAY.
- To use Web services other than CANON iMAGE GATEWAY, you must have an account with them. For further details, check the websites for each Web service you want to register.
- Separate ISP connection and access point fees may be applicable.

Before Use

Basic Guide

Advanced Guide

Camera Basics

Auto Mode /
Hybrid Auto Mode

Other Shooting Modes

P Mode

Tv, Av, and M Mode

Playback

Wireless Features

Setting Menu

Accessories

Appendix

Index



Registering CANON iMAGE GATEWAY

Link the camera and CANON iMAGE GATEWAY by adding CANON iMAGE GATEWAY as a destination Web service on the camera. Connect the devices near the access point, because you will need to press the WPS button. Note that you will need to enter an email address used on your computer or smartphone to receive a notification message for completing linkage settings.

1 Press the  button.

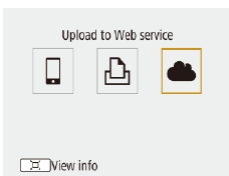

2 Choose .

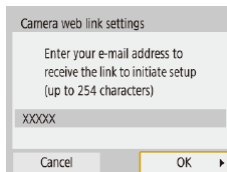

3 Accept the agreement to enter an email address.

- Read the agreement displayed and choose [I Agree].

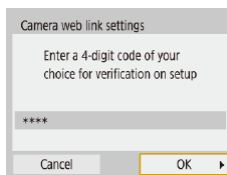
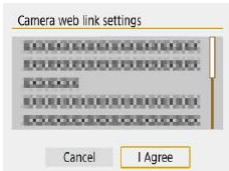

4 Establish a connection with an access point.

- Choose [Connect with WPS], and then choose [WPS (PBC mode)].
- Press the WPS button on the access point.
- Choose [Auto setting] on the camera's [IP address set.] screen to connect the camera to the access point.

5 Enter your email address.

- Once the camera is connected to CANON iMAGE GATEWAY, a screen is displayed for entering an email address.
- Enter your email address and continue.

6 Enter a four-digit number.

- Enter a four-digit number of your choice and continue.
- You will need this four-digit number later when setting up linkage with CANON iMAGE GATEWAY in step 8.

7 Check for the notification message.

- Once information has been sent to CANON iMAGE GATEWAY, you will receive a notification message at the email address entered in step 5.
- Press the  button on the next screen, which indicates that notification has been sent.

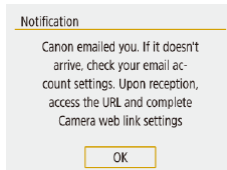

Before Use

Basic Guide

Advanced Guide

Camera Basics

Auto Mode /
Hybrid Auto Mode

Other Shooting Modes

P Mode

Tv, Av, and M Mode

Playback

Wireless Features

Setting Menu

Accessories

Appendix

Index

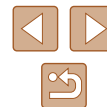

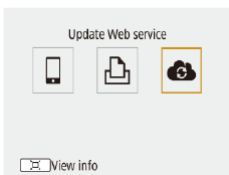

- [☁️] now changes to [☁️+].



8 Access the page in the notification message and complete camera link settings.

- From a computer or smartphone, access the page linked in the notification message.
- Follow the instructions to complete the settings on the camera link settings page.

9 Complete CANON iMAGE GATEWAY settings on the camera.

- Choose [☁️+].
- CANON iMAGE GATEWAY has now been added as a destination Web service.

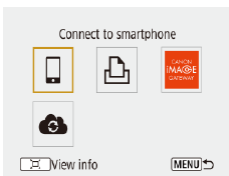

- Make sure initially that your computer or smartphone mail application is not configured to block email from relevant domains, which may prevent you from receiving the notification message.

Registering Other Web Services

You can also add Web services besides CANON iMAGE GATEWAY to the camera.



1 Log in to CANON iMAGE GATEWAY and access the camera link settings page.

- From a computer or smartphone, access <http://www.canon.com/cig/> to visit CANON iMAGE GATEWAY.



2 Configure the Web service you want to use.

- Follow the instructions displayed on the smartphone or computer to set up the Web service.

3 Choose [☁️+].

- Press the (F) button to choose [☁️+].



- If any configured settings change, follow these steps again to update the camera settings.

Before Use
Basic Guide
Advanced Guide
Camera Basics
Auto Mode / Hybrid Auto Mode
Other Shooting Modes
P Mode
Tv, Av, and M Mode
Playback
Wireless Features
Setting Menu
Accessories
Appendix
Index



Uploading Images to Web Services

1 Press the $\langle \text{P} \rangle$ button.

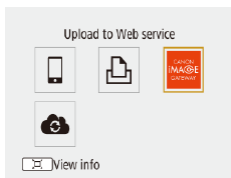

2 Choose the destination.

- Choose a Web service icon.
- If multiple recipients or sharing options are used with a Web service, choose an item on the screen displayed for selecting recipients.

3 Send an image.

- Choose sending options and upload the image.
- When uploading to YouTube, read the terms of service and choose [I Agree].
- After the image is sent, [OK] is displayed. Press the $\langle \text{P} \rangle$ button to return to the playback screen.



- To view images uploaded to CANON iMAGE GATEWAY on a smartphone, try the dedicated Canon Online Photo Album app. Download and install the Canon Online Photo Album app for iPhones or iPads from the App Store or for Android devices from Google Play.

Reconnecting via Wi-Fi

Reconnecting to devices or Web services via Wi-Fi is possible once the connection settings are registered.

1 Press the $\langle \text{P} \rangle$ button.

2 Choose an item.

- From the past connections shown, choose an item to connect to via Wi-Fi. If the item is not shown, press the $\langle \text{L} \rangle / \langle \text{R} \rangle$ buttons to switch to other screens.
- No past connections are displayed when $\langle \text{P} \rangle$ menu (23) > [Wireless communication settings] > [Wi-Fi settings] > [Connection history] is set to [Hide].

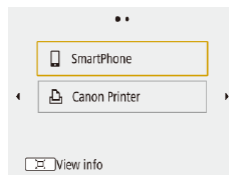

Web Services

- Step 3 is not necessary.

3 Prepare the other device.

Smartphones

- On the smartphone, turn on Wi-Fi and start Camera Connect.
- If the smartphone's settings were changed to connect to other devices, restore the settings to connect to the camera or the camera's access point via Wi-Fi. In direct Wi-Fi connections between the camera and smartphones, the SSID ends with _Canon0B.

Before Use

Basic Guide

Advanced Guide

Camera Basics

Auto Mode /
Hybrid Auto Mode

Other Shooting Modes

P Mode

Tv, Av, and M Mode

Playback

Wireless Features

Setting Menu

Accessories

Appendix

Index



Printers

- If the printer's settings were changed to connect to other devices, restore the settings to connect to the camera or the camera's access point via Wi-Fi. In direct Wi-Fi connections between the camera and printers, the SSID ends with _Canon0B.

Editing or Erasing Wireless Settings

Changing or Deleting Connection Settings

Connection settings saved on the camera can be changed or deleted. Before changing or deleting connection settings, end the Wi-Fi connection.

1 Press the **(P)** button.

2 Choose an item.

- On the screen shown at left, you can switch to other screens by pressing the ◀ / ▶ buttons.

- On the screen at left, choose an item with connection settings to delete or change.

3 Choose **[Edit device information]**.

- On the screen displayed, choose a device with connection settings to change or delete, and then change or delete the settings.

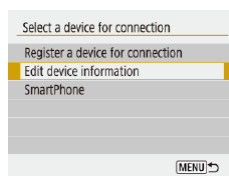
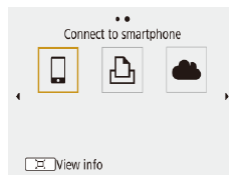
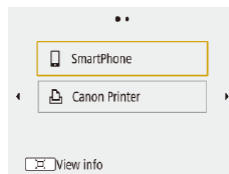

Before Use

Basic Guide

Advanced Guide

Camera Basics

Auto Mode /
Hybrid Auto Mode

Other Shooting Modes

P Mode

Tv, Av, and M Mode

Playback

Wireless Features

Setting Menu

Accessories

Appendix

Index



Restoring Default Wireless Settings

All wireless settings can be cleared. This can prevent the information from being leaked if you lend the camera or transfer ownership.

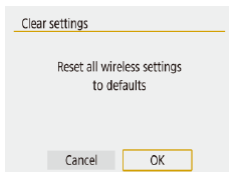

- Choose [MENU] menu (23) > [Wireless communication settings] > [Clear settings].

Clearing Information of Devices Paired via Bluetooth

Before pairing with a different smartphone, clear the information about any connected smartphones.

Steps on the Camera

- Choose [MENU] menu (23) > [Wireless communication settings] > [Bluetooth function] > [Check/clear connection info] and press the [OK] button.

Steps on the Smartphone

- In the Bluetooth setting menu on the smartphone, clear the camera information registered on the smartphone.

Before Use

Basic Guide

Advanced Guide

Camera Basics

Auto Mode /
Hybrid Auto Mode

Other Shooting Modes

P Mode

Tv, Av, and M Mode

Playback

Wireless Features

Setting Menu

Accessories

Appendix

Index

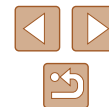

Setting Menu

Customize or adjust basic camera functions for greater convenience

Adjusting Basic Camera Functions

These settings are configured in the [F] menu (p.23). Customize commonly used functions as desired, for greater convenience.

Muting Camera Sounds

Prevent the camera from playing sounds when you press the shutter button halfway or activate the self-timer.

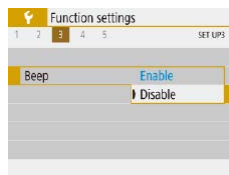

- Set [Beep] to [Disable].

Adjusting the Volume

Adjust the volume of individual camera sounds as follows.

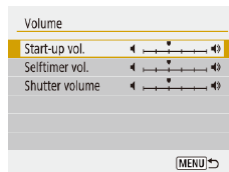



- Choose [Volume].
- Choose an item, and then press the ◀/▶ buttons to adjust the volume.

- Before Use
- Basic Guide
- Advanced Guide
 - Camera Basics
 - Auto Mode / Hybrid Auto Mode
 - Other Shooting Modes
 - P Mode
 - Tv, Av, and M Mode
 - Playback
 - Wireless Features
 - Setting Menu
 - Accessories
 - Appendix
- Index



Lens Retraction Timing

The lens is normally retracted for safety about one minute after you press the  button in shooting modes (1020). To have the lens retracted immediately after you press the  button, set the retraction timing to [0 sec.].

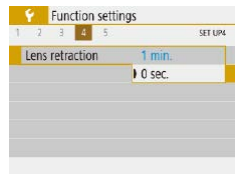

- Set [Lens retraction] to [0 sec.].

Using Eco Mode

This function allows you to conserve battery power in shooting modes. When the camera is not in use, the screen quickly darkens to reduce battery consumption.

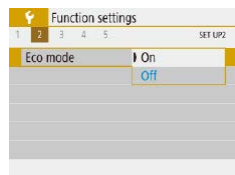

1 Configure the setting.

- Set [Eco mode] to [On].
- The screen darkens when the camera is not used for approximately two seconds; approximately ten seconds after darkening, the screen turns off. The camera turns off after approximately three minutes of inactivity.



2 Shoot.

- To activate the screen and prepare for shooting when the screen is off but the lens is still out, press the shutter button halfway.

Power-Saving Adjustment

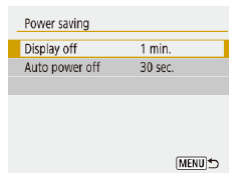
Adjust the timing of automatic camera and screen deactivation (Auto power off and Display off, respectively) as needed.



- Choose [Power saving].
- After choosing an item, press the / buttons to adjust it as needed.



- To conserve battery power, you should normally choose [30 sec.] for [Auto power off] and [1 min.] or less for [Display off].





- The [Display off] setting is applied even if you set [Auto power off] to [Disable].
- These power-saving functions are not available when you have set Eco mode (101) to [On].

Screen Brightness

Adjust screen brightness as follows.



- Choose [Disp. brightness], and then press the / buttons to adjust the brightness.

Before Use

Basic Guide

Advanced Guide

Camera Basics

Auto Mode /
Hybrid Auto Mode

Other Shooting Modes

P Mode

Tv, Av, and M Mode

Playback

Wireless Features

Setting Menu

Accessories

Appendix

Index





- For maximum brightness, press and hold the ▼ button for at least one second when the shooting screen is displayed or when in single-image display. (This will override the [Disp. brightness] setting on the [Fn] tab.) To restore the original brightness, press and hold the ▼ button again for at least one second or restart the camera.

Hiding the Start-Up Screen

If you prefer, you can deactivate display of the start-up screen normally shown when you turn the camera on.

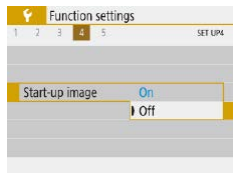

- Set [Start-up image] to [Off].

Formatting Memory Cards

Before using a new memory card or a card formatted in another device, you should format the card with this camera.

Formatting erases all data on a memory card. Before formatting, copy images on the memory card to a computer, or take other steps to back them up.

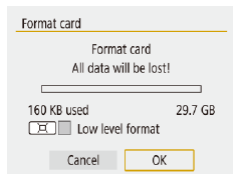

- Choose [Format card].
- To begin the formatting process, choose [OK].



- Formatting or erasing data on a memory card only changes file management information on the card and does not erase the data completely. When transferring or disposing of memory cards, take steps to protect personal information if necessary, as by physically destroying cards.



- The total card capacity indicated on the formatting screen may be less than the advertised capacity.

Low-Level Formatting

Perform low-level formatting in the following cases: [Memory card error] is displayed, the camera is not working correctly, card image reading/writing is slower, continuous shooting is slower, or movie recording suddenly stops. Low-level formatting erases all data on a memory card. Before low-level formatting, copy images on the memory card to a computer, or take other steps to back them up.

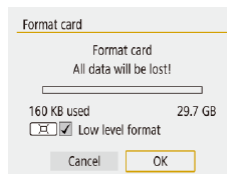

- On the “Formatting Memory Cards” screen (102), press the [OK] button to display [✓].
- To begin the formatting process, choose [OK].



- Low-level formatting takes longer than “Formatting Memory Cards” (102), because data is erased from all storage regions of the memory card.
- You can cancel low-level formatting in progress by choosing [Cancel]. In this case, all data will be erased, but the memory card can be used normally.

- Before Use
- Basic Guide
- Advanced Guide
 - Camera Basics
 - Auto Mode / Hybrid Auto Mode
 - Other Shooting Modes
 - P Mode
 - Tv, Av, and M Mode
 - Playback
 - Wireless Features
 - Setting Menu
 - Accessories
 - Appendix
- Index



Selecting and Creating Folders

You can select or create folders where images are saved. New folders can be created by selecting [Create folder] on the folder selection screen.

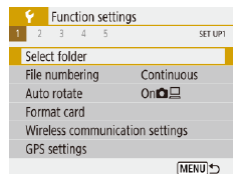

1 Access the [Select folder] screen.

- Choose [Select folder].

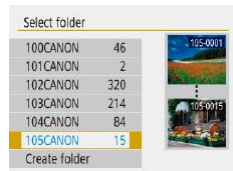

2 Configure the setting.

- Choose a folder for image storage.
- To create a new folder, choose [Create folder].



- Folders are named as in 100CANON, with a three-digit folder number followed by five letters or numbers.
- Folders with numbers in the range 100 – 999 can be created.

File Numbering

Your shots are automatically numbered in sequential order (0001 – 9999) and saved in folders that store up to 9,999 images each. You can change how the camera assigns file numbers.

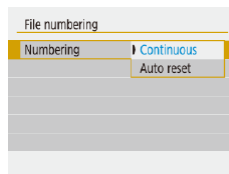

- Choose [File numbering], and then choose the desired option.

Continuous	Images are numbered consecutively (until the 9999th shot is taken/saved) even if you switch memory cards.
Auto reset	Image numbering is reset to 0001 if you switch memory cards, or when a new folder is created.
Manual reset	Creates a new folder and starts numbering images from 0001.



- Regardless of the option selected in this setting, shots may be numbered consecutively after the last number of existing images on newly inserted memory cards. To start saving shots from 0001, use an empty (or formatted, 102) memory card.

Before Use

Basic Guide

Advanced Guide

Camera Basics

Auto Mode /
Hybrid Auto Mode

Other Shooting Modes

P Mode

Tv, Av, and M Mode

Playback

Wireless Features

Setting Menu

Accessories

Appendix

Index



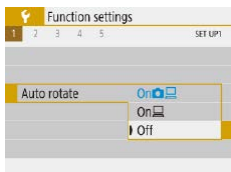

Deactivating Auto Rotation

Follow these steps to deactivate automatic image rotation, which rotates images displayed on the camera or a computer based on the camera orientation.





- Set [Auto rotate] to [Off].

On 	Automatically rotate images during playback on both the camera and computers.
On 	Automatically rotate images during playback on computers.
Off	Do not automatically rotate images.



- Images captured with [Auto rotate] set to [Off] are not rotated automatically if you later set it to [On].

Metric / Non-Metric Display

Change the unit of measurement shown in the zoom bar (26), the MF indicator (56), and elsewhere from m/cm to ft/in as needed.

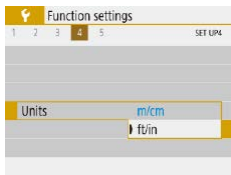

- Set [Units] to [ft/in].

Checking Certification Logos

Some logos for certification requirements met by the camera can be viewed on the screen. Other certification logos are printed in this guide, on the camera packaging, or on the camera body.

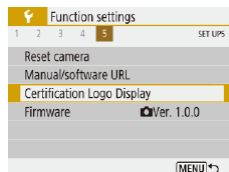

- Choose [Certification Logo Display].

Display Language

Change the display language as needed.



- In [Language , choose the language.

Before Use

Basic Guide

Advanced Guide

Camera Basics

Auto Mode /
Hybrid Auto Mode

Other Shooting Modes

P Mode

Tv, Av, and M Mode

Playback

Wireless Features

Setting Menu

Accessories

Appendix

Index

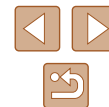

Changing the HDMI Output Resolution

It may take some time before display on a TV via HDMI when you switch to a movie with a different resolution. You can eliminate the delay before display by converting 4K movies to full HD and setting the output resolution to full HD.

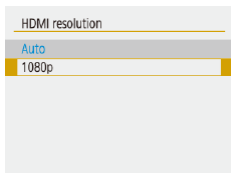

- Set [HDMI resolution] to [1080p].

Adjusting Other Settings

The following settings can also be adjusted from the [Q] menu.

- [Video system] (📖108)
- [Wireless communication settings] (📖83)
- [GPS settings] (📖87)
- [Reverse display] (📖22)

Restoring Default Camera Settings

If you accidentally change a setting, you can restore default camera settings.

Restoring Camera Defaults

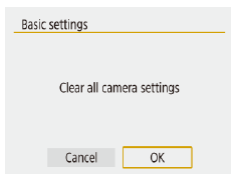

- In [Reset camera], choose [Basic settings].
- Once you choose [OK], camera defaults are restored.



- The following functions are not restored to default settings.
 - [Q] menu (📖23) > [Date/Time/Zone] (📖16), [Language] (📖104), and [Video system] (📖108) settings
 - Information other than [Bluetooth function] that is registered in [Wireless communication settings] (📖83)

Restoring Default Wireless Settings

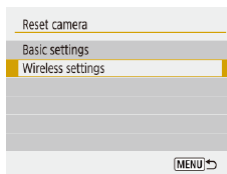

- In [Reset camera], choose [Wireless settings].
- Once you choose [OK], the defaults for wireless communication are restored.

Hiding Feature Guidance

Feature guidance is normally shown when you choose Quick Control (📖23) or MENU (📖23) items. If you prefer, you can deactivate this information.

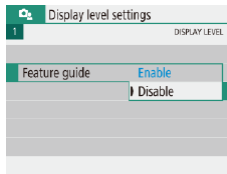

- Choose [📷] menu (📖23) > [Feature guide] > [Disable].



- You can change how menus are displayed in [📷] menu (📖23) > [Menu display].

Before Use

Basic Guide

Advanced Guide

Camera Basics

Auto Mode /
Hybrid Auto Mode

Other Shooting Modes

P Mode

Tv, Av, and M Mode

Playback

Wireless Features

Setting Menu

Accessories

Appendix

Index

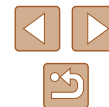

Accessories

Enjoy the camera in more ways with optional Canon accessories and other compatible accessories sold separately

System Map

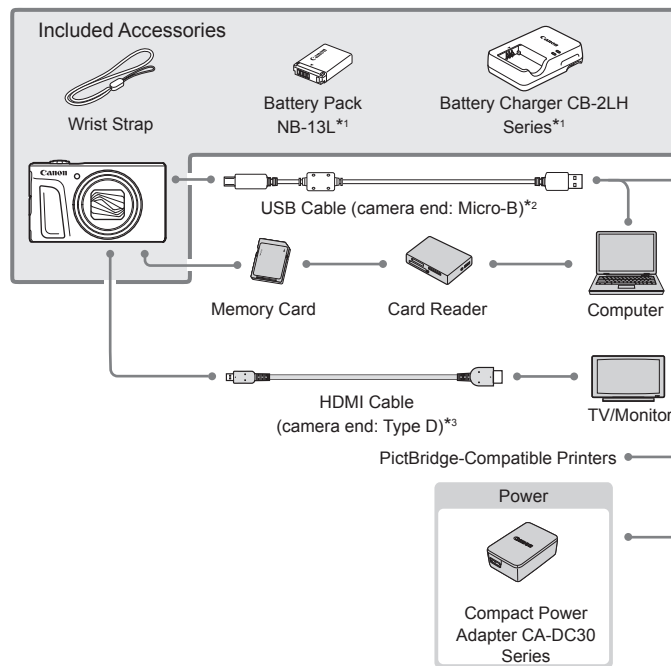

*1 Also available for purchase separately.

*2 A genuine Canon accessory is also available (Interface Cable IFC-600PCU).

*3 Use a commercially available cable no longer than 2.5 m (8.2 ft.).

Before Use

Basic Guide

Advanced Guide

Camera Basics

Auto Mode /
Hybrid Auto Mode

Other Shooting Modes

P Mode

Tv, Av, and M Mode

Playback

Wireless Features

Setting Menu

Accessories

Appendix

Index

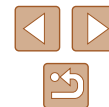

Use of genuine Canon accessories is recommended.

This product is designed to achieve excellent performance when used with genuine Canon accessories. Canon shall not be liable for any damage to this product and/or accidents such as fire, etc., caused by the malfunction of non-genuine Canon accessories (e.g., a leakage and/or explosion of a battery pack). Please note that any repairs your Canon product may require as a result of such malfunction are not covered under warranty and will incur a fee.

Optional Accessories

The following camera accessories are sold separately. Note that availability varies by area, and some accessories may no longer be available.

Power Supplies

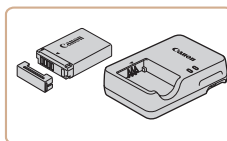

Battery Pack NB-13L

- Rechargeable lithium-ion battery

Battery Charger CB-2LH Series

- Charger for Battery Pack NB-13L



- The battery charger can be used in areas with 100 – 240 V AC power (50/60 Hz).
- For power outlets in a different format, use a commercially available adapter for the plug. Never use an electrical transformer designed for traveling, which may damage the battery pack.
- The message [Battery communication error.] is displayed if you use a non-genuine Canon battery pack, and user response is required. Note that Canon shall not be liable for any damages resulting from accidents, such as malfunction or fire, that occur due to use of non-genuine Canon battery packs.



- The battery pack includes a convenient cover which you can attach to know the charge status at a glance. Attach the cover so that ▲ is visible on a charged battery pack, and attach it so that ▲ is not visible on an uncharged battery pack.

Before Use

Basic Guide

Advanced Guide

Camera Basics

Auto Mode /
Hybrid Auto Mode

Other Shooting Modes

P Mode

Tv, Av, and M Mode

Playback

Wireless Features

Setting Menu

Accessories

Appendix

Index



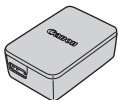

Compact Power Adapter CA-DC30 Series

- Insert the included battery pack into the camera for charging. Interface Cable IFC-600PCU (sold separately) is required to connect the adapter to the camera.

Other Accessories

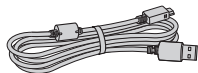

Interface Cable IFC-600PCU

- For connecting the camera to a computer or printer.

Printers



Canon PictBridge-Compatible Printers

- Even without using a computer, you can print images by connecting the camera directly to a printer.

Using Optional Accessories

Playback on a TV

▶ Still Images ▶ Movies

You can view your shots on a TV by connecting the camera to an HDTV with a commercially available HDMI cable (not exceeding 2.5 m / 8.2 ft., with a Type D terminal on the camera end).

For details on connection or how to switch inputs, refer to the TV manual.



- Some information may not be displayed when viewing images on a TV (📖 120).

1 Make sure the camera and TV are off.

2 Connect the camera to the TV.

- On the TV, insert the cable plug fully into the HDMI input as shown.

- On the camera, open the terminal cover and insert the cable plug fully into the camera terminal.

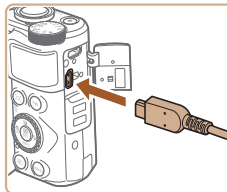
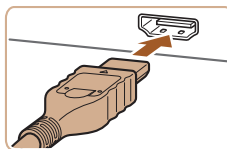

Before Use

Basic Guide

Advanced Guide

Camera Basics

Auto Mode /
Hybrid Auto Mode

Other Shooting Modes

P Mode

Tv, Av, and M Mode

Playback

Wireless Features

Setting Menu

Accessories

Appendix

Index



3 Turn the TV on and switch to external input.

- Switch the TV input to the external input you connected the cable to in step 2.

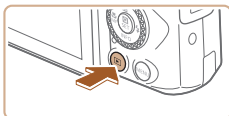

4 Turn the camera on.

- Press the  button to turn the camera on.
- Images from the camera are now displayed on the TV. (Nothing is displayed on the camera screen.)
- When finished, turn off the camera and TV before disconnecting the cable.



- During HDMI output, display of the next image may take some time if you switch between 4K and HD movies, or movies of different frame rates.



- When the camera and TV are connected, you can also shoot while previewing shots on the larger screen of the TV. To shoot, follow the same steps as when using the camera screen.

Inserting and Charging the Battery Pack

Charge the battery pack by using the supplied battery pack with an optional Compact Power Adapter CA-DC30 Series and Interface Cable IFC-600PCU.

1 Insert the battery pack.

- Follow step 1 in “Inserting the Battery Pack and Your Memory Card” (📖15) to open the cover.
- Insert the battery pack as described in step 2 of “Inserting the Battery Pack and Your Memory Card” (📖15).
- Follow step 4 in “Inserting the Battery Pack and Your Memory Card” (📖16) to close the cover.

2 Connect the compact power adapter to the camera.

- With the camera turned off, open the cover (1). Hold the smaller plug of the interface cable (sold separately) facing as shown and insert the plug fully into the camera terminal (2).
- Insert the larger plug of the interface cable into the compact power adapter.

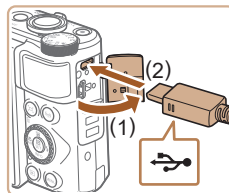

Before Use

Basic Guide

Advanced Guide

Camera Basics

Auto Mode /
Hybrid Auto Mode

Other Shooting Modes

P Mode

Tv, Av, and M Mode

Playback

Wireless Features

Setting Menu

Accessories

Appendix

Index



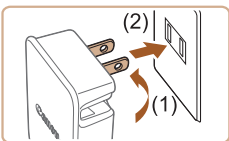

3 Charge the battery pack.

- Plug the compact power adapter into a power outlet as shown.
- If your compact power adapter has a power cord, connect the power cord to the adapter, and then plug the other end into the power outlet.

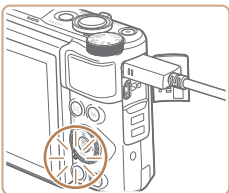
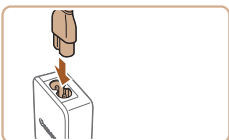

- Charging begins and the USB charge lamp lights up.
- The lamp turns off when charging finishes.
- Remove the compact power adapter from the power outlet and the interface cable from the camera.



- To protect the battery pack and keep it in optimal condition, do not charge it continuously for more than 24 hours.
- When charging another battery pack, always disconnect the interface cable from the camera before replacing the battery pack for charging.



- If the USB charge lamp is not lit, reconnect the interface cable.
- Charged battery packs gradually lose their charge, even when they are not used. Charge the battery pack on (or immediately before) the day of use.
- The charger can be used in areas with 100 – 240 V AC power (50/60 Hz). For power outlets in a different format, use a commercially available adapter for the plug. Never use an electrical transformer designed for traveling, which may damage the battery pack.

Before Use
Basic Guide
Advanced Guide
Camera Basics
Auto Mode / Hybrid Auto Mode
Other Shooting Modes
P Mode
Tv, Av, and M Mode
Playback
Wireless Features
Setting Menu
Accessories
Appendix
Index



Using a Computer to Charge the Battery

You can also charge the battery pack by inserting the larger plug of the interface cable into a computer's USB terminal in step 2 of "Inserting and Charging the Battery Pack" (📖109). For details about USB connections on the computer, refer to the computer user manual. We recommend using Interface Cable IFC-600PCU (sold separately).

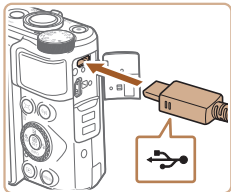

- With the camera turned off, open the cover. With the smaller plug of the cable in the orientation shown, insert the plug fully into the camera terminal.

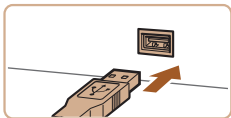

- Connect the larger cable plug to the computer. For details on computer connections, refer to the computer user manual.

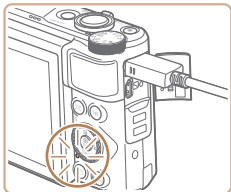

- Charging now begins, and the indicator on the back of the camera is lit in orange.
- However, charging may take longer if you import images on the camera to the computer, as described in "Saving Images to a Computer" (📖112).
- The lamp turns off when charging finishes.



- Charging may take longer if you import images from the camera to a computer, as described in "Saving Images to a Computer" (📖112).
- Charging stops and the indicator goes off if, after you begin charging as described above, you press the power button to turn the camera off.
- With some computers, battery charging may require the memory card to be in the camera. Insert the memory card in the camera (📖15) before connecting the cable to the computer's USB port.

Using the Software

To utilize the features of the following software, download the software from the Canon website and install it on your computer.

- Image Transfer Utility 2
 - Automatically send images to a computer (📖91)
- Map Utility
 - Use a map to view GPS information that has been added to images



- To view and edit images on a computer, use preinstalled or commonly available software compatible with images captured by the camera.



- Download and install the latest software from the Canon website.

Before Use

Basic Guide

Advanced Guide

Camera Basics

Auto Mode /
Hybrid Auto Mode

Other Shooting Modes

P Mode

Tv, Av, and M Mode

Playback

Wireless Features

Setting Menu

Accessories

Appendix

Index



Saving Images to a Computer

Using Interface Cable IFC-600PCU or a USB cable (both sold separately; camera end: Micro-B), you can connect the camera to a computer and save images to the computer.

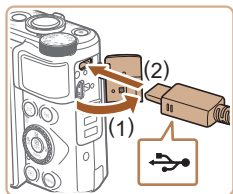

1 Connect the camera to the computer.

- With the camera turned off, open the cover (1). With the smaller plug of the USB cable in the orientation shown, insert the plug fully into the camera terminal (2).

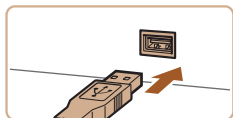

- Connect the larger cable plug to the computer. For details on computer connections, refer to the computer user manual.
- The camera automatically turns on when you connect it to the computer.

2 Save the images to the computer.

- To open images, use preinstalled or commonly available software.

Printing Images

► Still Images ► Movies

Your shots can easily be printed by connecting the camera to a printer. On the camera, you can specify images to set up batch printing, prepare orders for photo development services, and prepare orders or print images for photobooks.

A Canon SELPHY CP series compact photo printer is used here for the sake of illustration. Screens displayed and available functions vary by printer. Also refer to the printer manual for additional information.

Easy Print

► Still Images ► Movies

Print your shots by connecting the camera to a PictBridge-compatible printer with a USB cable (sold separately; camera end: Micro-B).

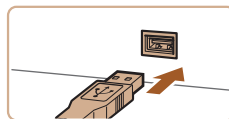
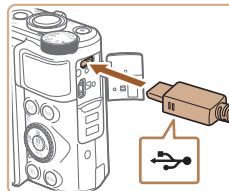

1 Make sure the camera and printer are off.

2 Connect the camera to the printer.

- Open the terminal cover and insert the smaller plug fully into the camera terminal in the orientation shown.
- Connect the larger cable plug to the printer. For other connection details, refer to the printer manual.

3 Turn the printer on.

Before Use

Basic Guide

Advanced Guide

Camera Basics

Auto Mode /
Hybrid Auto Mode

Other Shooting Modes

P Mode

Tv, Av, and M Mode

Playback

Wireless Features

Setting Menu

Accessories

Appendix

Index



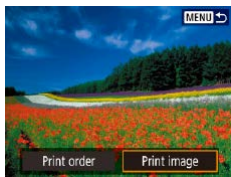

4 Choose an image.

5 Access the printing screen.

- Press the button, choose [Print image], and then press the button again.

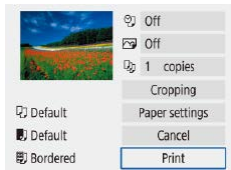

6 Print the image.

- Choose [Print].
- Printing now begins.
- To print other images, after printing is finished, repeat this procedure from step 4.
- When you are finished printing, turn the camera and printer off and disconnect the cable.

Configuring Print Settings

▶ Still Images ▶ Movies

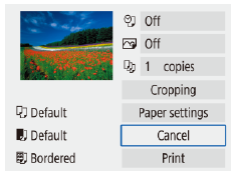

1 Access the printing screen.

- Follow steps 1 – 5 in “Easy Print” (112) to access this screen.

2 Configure the settings.

- Choose an item, and then choose the desired option.

Adding Images to the Print Orders (DPOF)

▶ Still Images ▶ Movies

Set up batch printing (up to 400 images) or ordering prints from a photo development service (up to 998 images) by choosing the images on a memory card and the number of copies. The printing information you prepare this way will conform to DPOF (Digital Print Order Format) standards.

- Movies cannot be selected.

Configuring Print Settings

Specify the printing format, whether to add the date or file number, and other settings as follows. These settings apply to all images in the print order.

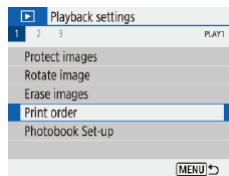

1 Choose [Print order].

- Choose [] menu (23) > [Print order].

Before Use
Basic Guide
Advanced Guide
Camera Basics
Auto Mode / Hybrid Auto Mode
Other Shooting Modes
P Mode
Tv, Av, and M Mode
Playback
Wireless Features
Setting Menu
Accessories
Appendix
Index

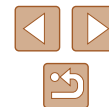

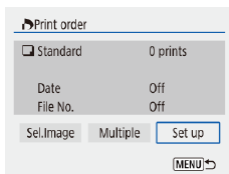

2 Choose [Set up].

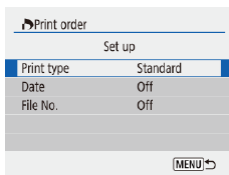

- Choose an item to configure, and then choose the desired option.
- Press the **MENU** button to return to the printing screen.



- Not all of your DPOF settings may be applied in printing by the printer or photo development service, in some cases.
- Do not use this camera to configure print settings for images with DPOF settings set up on another camera. Changing the print settings using this camera may overwrite all previous settings.
- Setting [Date] to [On] may cause some printers to print the date twice.

Specifying Images to Print

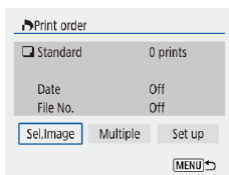

1 Choose images to print.

- Follow step 1 in “Configuring Print Settings” (📖113) to access the screen at left.
- Choose [Sel.Image] or [Multiple], and then press the **MENU** button.
- Follow the instructions displayed to add images for printing, and then press the **MENU** button.

Printing Images Added to the Print Order (DPOF)

▶ Still Images ▶ Movies

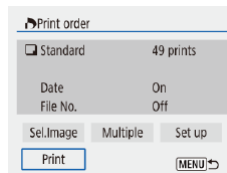

- The playback screen is displayed when you connect the camera to a PictBridge-compatible printer.
To access this screen, press the **MENU** button and choose [Print order] on the screen displayed.
- Choose [Print], and then choose [OK] on the next screen to print the images.
- Any DPOF print job that you temporarily stop will be resumed from the next image.

Before Use
Basic Guide
Advanced Guide
Camera Basics
Auto Mode / Hybrid Auto Mode
Other Shooting Modes
P Mode
Tv, Av, and M Mode
Playback
Wireless Features
Setting Menu
Accessories
Appendix
Index



Adding Images to a Photobook

Photobooks can be set up by choosing up to 998 images on a memory card.

Adding Images Individually

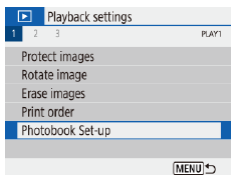

1 Choose [Photobook Set-up].

- Choose [▶] menu (📖23) > [Photobook Set-up].

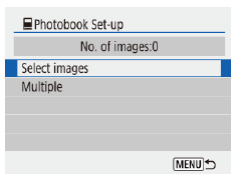

2 Choose [Select images].



3 Choose an image.

- Choose an image and press the button.
- [✓] is displayed.
- To remove the image from the photobook, press the button again. [✓] is no longer displayed.
- Repeat this process to specify other images.
- When finished, press the **MENU** button to return to the menu screen.

Adding Multiple Images at Once

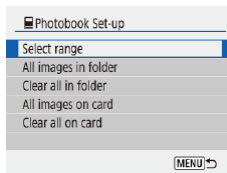

- In step 2 in “Adding Images Individually” (📖115), choose [Multiple] to access the screen at left.
- Choose an item, and then press the button.
- Follow the instructions displayed to add images.



- Do not use this camera to configure print settings for images with DPOF settings set up on another camera. Changing the print settings using this camera may overwrite all previous settings.



- Movies cannot be selected.

Before Use
Basic Guide
Advanced Guide
Camera Basics
Auto Mode / Hybrid Auto Mode
Other Shooting Modes
P Mode
Tv, Av, and M Mode
Playback
Wireless Features
Setting Menu
Accessories
Appendix
Index

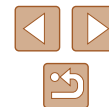

Appendix

Helpful information when using the camera

Troubleshooting

If you think there is a problem with the camera, first check the following. If the issue persists, contact a Customer Support Help Desk.

Power

Nothing happens when the power button is pressed.

- Dirty battery terminals reduce battery performance. Try cleaning the terminals with a cotton swab and reinserting the battery pack a few times.

The battery pack runs out of power quickly.

- Battery performance decreases at low temperatures. Try warming the battery pack a little by putting it in your pocket, for example, ensuring that the terminals do not touch any metal objects.
- Dirty battery terminals reduce battery performance. Try cleaning the terminals with a cotton swab and reinserting the battery pack a few times.
- If these measures do not help and the battery pack still runs out of power soon after charging, it has reached the end of its life. Purchase a new battery pack.

The battery pack is swollen.

- Battery swelling is normal and does not pose any safety concerns. However, if battery swelling prevents the battery pack from fitting in the camera, contact a Customer Support Help Desk.

Shooting

Cannot shoot.

- During playback (📖67), press the shutter button halfway (📖21).

Strange display on the screen when shooting.

- Note that the following display problems are not recorded in still images but are recorded in movies.
 - The screen may flicker and horizontal banding may appear under fluorescent or LED lighting.

Before Use

Basic Guide

Advanced Guide

Camera Basics

Auto Mode /
Hybrid Auto Mode

Other Shooting Modes

P Mode

Tv, Av, and M Mode

Playback

Wireless Features

Setting Menu

Accessories

Appendix

Index

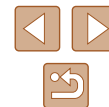

Movie recording or playback suddenly stops.

- For [4K 29.97P] or [4K 25.00P], use a UHS-I memory card with a UHS speed class of 3.

Shots are out of focus.

- Confirm that unneeded functions such as macro are deactivated.
- Try shooting with focus lock or AF lock (p.59, p.60).

No AF points are displayed and the camera does not focus when the shutter button is pressed halfway.

- To have AF points displayed and the camera focus correctly, try composing the shot with higher-contrast subject areas centered before pressing the shutter button halfway (or pressing it halfway repeatedly).

Subjects in shots look too dark.

- Adjust brightness by using exposure compensation (p.52).
- Use AE lock or spot metering (p.52, p.52).

Subjects look too bright, highlights are washed-out.

- Adjust brightness by using exposure compensation (p.52).
- Use AE lock or spot metering (p.52, p.52).
- Reduce the lighting on subjects.

Shots look too dark despite the flash firing (p.29).

- Adjust brightness by using flash exposure compensation or changing the flash output level (p.62, p.66).
- Increase the ISO speed (p.53).

Subjects in flash shots look too bright, highlights are washed-out.

- Adjust brightness by using flash exposure compensation or changing the flash output level (p.62, p.66).

Shooting Movies

Subjects look distorted.

- Subjects that pass in front of the camera quickly may look distorted.

Wi-Fi

Cannot access the Wi-Fi menu by pressing the (P) button.

- The Wi-Fi menu cannot be accessed while the camera is connected to a printer or computer via a cable. Disconnect the cable.

Cannot connect to the access point.

- Confirm that the access point channel is set to a channel supported by the camera (p.123). Note that instead of auto channel assignment, it is advisable to specify a supported channel manually.

Images take a long time to send./The wireless connection is disrupted.

- Do not use the camera near sources of Wi-Fi signal interference such as microwave ovens or other equipment operating on the 2.4 GHz band.
- Bring the camera closer to the other device you are trying to connect to (such as the access point), and make sure there are no objects between the devices.

Before Use
Basic Guide
Advanced Guide
Camera Basics
Auto Mode / Hybrid Auto Mode
Other Shooting Modes
P Mode
Tv, Av, and M Mode
Playback
Wireless Features
Setting Menu
Accessories
Appendix
Index



Errors and Warnings

If an error message is displayed, respond as follows.

Error Codes

- In case of problems with the camera, error codes (in the format Errxx) and recommended responses are displayed.

Number	Message and Response
02	Card cannot be accessed. Reinsert/change card or format card with camera.
	→ Reinsert the memory card, use a different card, or format the card.
04	Cannot save images because card is full. Replace card.
	→ Use a different memory card, erase unneeded images, or format the card.
10, 20, 30, 40, 50, 60, 70, 80, 99	An error prevented shooting. Turn the camera off and on again or re-install the battery.
	→ Use the power button or reinsert the battery pack.

* If the problem persists, write down the error code (Errxx) and contact a Customer Support Help Desk.

Wi-Fi

Device with same IP address exists on selected network

- Reset the IP address so that it does not conflict with another.

Disconnected/Could not send the image

- You may be in an environment where Wi-Fi signals are obstructed.
- Avoid using the camera's Wi-Fi function around microwave ovens and other devices that operate on the 2.4 GHz band.
- Bring the camera closer to the other device you are trying to connect to (such as the access point), and make sure there are no objects between the devices.
- Check the connected device to make sure it is not experiencing errors.

Not enough free space on server

- Delete unneeded images on the server and check the free space before you attempt transmission again.

Check the network settings

- Make sure your computer can connect to the Internet under the current network settings.

Before Use

Basic Guide

Advanced Guide

Camera Basics

Auto Mode /
Hybrid Auto Mode

Other Shooting Modes

P Mode

Tv, Av, and M Mode

Playback

Wireless Features

Setting Menu

Accessories

Appendix

Index

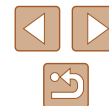

On-Screen Information

Shooting (Detailed Information Display)

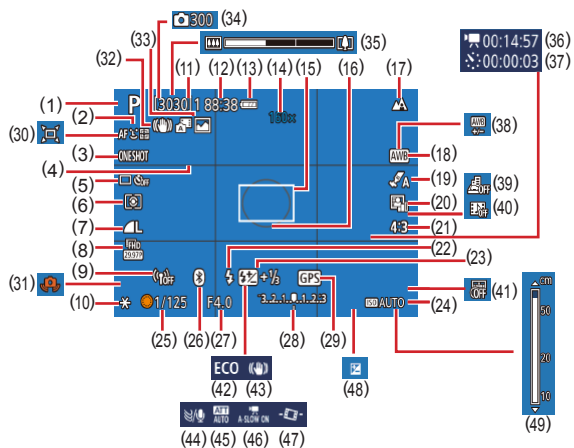

- (1) Shooting mode, Scene icon (129)
- (2) AF method (57)
- (3) AF operation (59)
- (4) Grid lines (35)
- (5) Drive mode (33, 34)
- (6) Metering mode (52)
- (7) Image quality (35)
- (8) Movie recording size (47)
- (9) Wi-Fi signal strength
- (10) AE lock (52)
- (11) Available shots, Maximum continuous shots
- (12) Remaining time
- (13) Battery level (119)
- (14) Zoom magnification (30), Digital tele-converter (57)
- (15) AF point (57)
- (16) Spot AE point frame (52)
- (17) Focus range (56, 56), AF lock (60)
- (18) White balance (54)

- (19) Style settings (55)
- (20) Auto Lighting Optimizer (53)
- (21) Still image aspect ratio (34)
- (22) Flash mode (61), FE lock (62)
- (23) Flash exposure compensation (62), Flash mode (66)
- (24) ISO speed (53)
- (25) Shutter speed (64, 65)
- (26) Bluetooth connection status (85)
- (27) Aperture value (65, 65)
- (28) Exposure level (65)
- (29) Bluetooth smartphone connection, GPS acquisition status (87)
- (30) Auto (31)
- (31) Camera shake warning (29)
- (32) Intelligent IS (30)
- (33) Hybrid Auto mode / Digest type (28)
- (34) No. of shots (49)
- (35) Zoom bar (26)
- (36) Time required (49)
- (37) Playback time (49)
- (38) White balance correction (55)
- (39) Miniature effect movie (49)
- (40) Video snapshot (50)
- (41) Date stamp (33)
- (42) Eco mode (101)
- (43) IS mode (63)
- (44) Wind filter (48)
- (45) Attenuator (48)
- (46) Auto slow shutter (48)
- (47) Auto level (36)
- (48) Exposure compensation level (52)
- (49) MF indicator (56)

Battery Level

An on-screen icon or message indicates the battery charge level.

Display	Details
	Sufficient charge
	Slightly depleted, but sufficient
	Nearly depleted—charge the battery pack soon
	Depleted—charge the battery pack immediately

- Before Use
- Basic Guide
- Advanced Guide
 - Camera Basics
 - Auto Mode / Hybrid Auto Mode
 - Other Shooting Modes
 - P Mode
 - Tv, Av, and M Mode
 - Playback
 - Wireless Features
 - Setting Menu
 - Accessories
 - Appendix
- Index



Playback (Detailed Information Display)

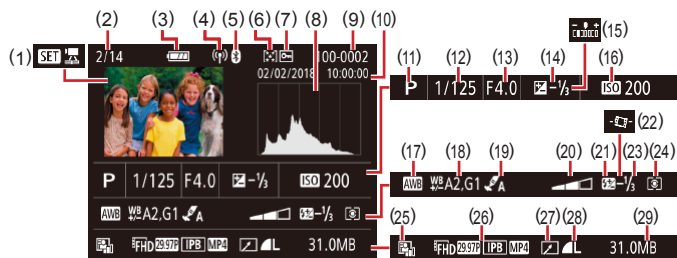

- | | |
|--|--|
| (1) Movie playback (📖26, 📖67), Digest movie playback (📖28) | (15) Brightness (📖39) |
| (2) Current image no. / Total no. of images | (16) ISO speed (📖53) |
| (3) Battery level (📖119) | (17) White balance (📖54) |
| (4) Wi-Fi signal strength | (18) White balance correction (📖55) |
| (5) Bluetooth connection status (📖85) | (19) Style settings (📖55) |
| (6) Rating (📖77) | (20) Filter effect (📖39) |
| (7) Image protection (📖72) | (21) Flash (📖61) |
| (8) Histogram (📖69) | (22) 📢 Auto level (📖36) |
| (9) Folder number - File number (📖103) | (23) Flash exposure compensation (📖62), Movie compression (📖80) |
| (10) Shooting date/time (📖16) | (24) Metering method (📖52) |
| (11) Shooting mode | (25) Auto Lighting Optimizer (📖53) |
| (12) Shutter speed (📖64, 📖65) | (26) Movie recording size (📖47) |
| (13) Aperture value (📖65, 📖65) | (27) Image editing (📖77) |
| (14) Exposure compensation level (📖52) | (28) Still images: Image quality (📖35)*
Movies: Playback time |
| | (29) File size |

* Cropped images are labeled with [📐].

Before Use

Basic Guide

Advanced Guide

Camera Basics

Auto Mode /
Hybrid Auto Mode

Other Shooting Modes

P Mode

Tv, Av, and M Mode

Playback

Wireless Features

Setting Menu

Accessories

Appendix

Index

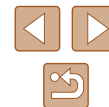

Handling Precautions

- The camera is a high-precision electronic device. Avoid dropping it or subjecting it to strong impact.
- Never bring the camera near magnets, motors, or other devices that generate strong electromagnetic fields. Strong electromagnetic fields may cause malfunction or erase image data.
- If water droplets or dirt adheres to the camera or screen, wipe with a dry soft cloth, such as an eyeglass cloth. Do not rub hard or apply force.
- Never use cleaners containing organic solvents to clean the camera or screen.
- Use a blower brush to remove dust from the lens. If cleaning is difficult, contact a Customer Support Help Desk.
- Store unused battery packs in a plastic bag or other container. To maintain battery performance if you will not use the battery pack for some time, about once a year charge it and then use the camera until it runs out of power before storing the battery pack.

Specifications





Image Sensor

Image size 1/2.3 type
 Camera effective pixels
 (Image processing may cause
 a decrease in the number of pixels.) approx. 20.3 megapixels
 Total pixels approx. 21.1 megapixels

Lens

Focal length
 (35mm film equivalent) 4.3 – 172.0 mm
 (24 – 960 mm)
 Zoom magnification 40x

Shooting range (measured from the tip of the lens)

Shooting Mode	Focus Range	Maximum Wide Angle ()	Maximum Telephoto ()
AUTO*	–	1 cm (0.4 in.) – Infinity	2.0 m (6.6 ft.) – Infinity
Other than the above		5 cm (2.0 in.) – Infinity	2.0 m (6.6 ft.) – Infinity
		1 – 50 cm (0.4 in. – 1.6 ft.)	–

* Manual Focus is the same.

Before Use

Basic Guide

Advanced Guide

Camera Basics

Auto Mode /
Hybrid Auto Mode

Other Shooting Modes

P Mode

Tv, Av, and M Mode

Playback

Wireless Features

Setting Menu

Accessories

Appendix

Index

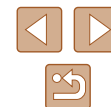

Shutter

Shutter speed

Auto Mode (automatic settings)

Max. Tv	1 sec.
Min. Tv	1/3200 sec.

Range in all shooting modes

Max. Tv	15 sec.
Min. Tv	1/3200 sec.

Available Tv values (sec.)

Shooting mode	M mode / Tv mode
	15, 13, 10, 8, 6, 5, 4, 3.2, 2.5, 2, 1.6, 1.3, 1, 0.8, 0.6, 0.5, 0.4, 0.3, 1/4, 1/5, 1/6, 1/8, 1/10, 1/13, 1/15, 1/20, 1/25, 1/30, 1/40, 1/50, 1/60, 1/80, 1/100, 1/125, 1/160, 1/200, 1/250, 1/320, 1/400, 1/500, 1/640, 1/800, 1/1000, 1/1250, 1/1600, 1/2000, 1/2500, 1/3200

Aperture

F number

Wide angle	3.3 – 8.0
Telephoto	6.9 – 8.0

Flash Control

Built-in Flash

Flash range (Max. wide angle)

closest point	approx. 50 cm (1.6 ft.)
farthest point	approx. 5.0 m (16.4 ft.)

Flash range (Telephoto end)

closest point	approx. 2.0 m (6.6 ft.)
farthest point	approx. 2.5 m (8.2 ft.)

Screen

Type	TFT color liquid crystal
Screen Size	3.0 type
Number of dots	approx. 0.92 million dots

Shooting

Digital zoom

Magnification	approx. 4x
Maximum with optical zoom	approx. 160x
Focal length (telephoto end, 35mm film equivalent)	approx. 3840 mm equivalent
ZoomPlus (Number of recording pixels L)	approx. 80x

Continuous shooting

Shooting speed*	
One-Shot AF	
Continuous shooting speed (high-speed)	maximum approx. 10.0 shots/sec.
Continuous shooting speed (low-speed)	maximum approx. 4.0 shots/sec.
Servo AF	
Continuous shooting speed (high-speed)	maximum approx. 7.4 shots/sec.
Continuous shooting speed (low-speed)	maximum approx. 4.0 shots/sec.

* Continuous shooting speed may become slower due to the following factors:
Tv value/Av value/Subject conditions/Shooting environment/Use of flash/ISO Speed/Zoom position

Before Use

Basic Guide

Advanced Guide

Camera Basics

Auto Mode / Hybrid Auto Mode

Other Shooting Modes

P Mode

Tv, Av, and M Mode

Playback

Wireless Features

Setting Menu

Accessories

Appendix

Index



Recording

File format DCF-compliant DPOF compatible
(Version 1.1)

Data type

Still image

Recording format Exif 2.31 (DCF2.0)
Image JPEG only

Movie

Recording format MP4
Video MPEG-4 AVC/H.264
Audio MPEG-4 AAC-LC (stereo)

Power

Battery Pack NB-13L

Number of still image shots (CIPA compliant: room temperature 23°C / 73°F)	approx. 265 shots
Number of still image shots (Eco Mode On)	approx. 370 shots
Movie recording time (CIPA compliant: room temperature 23°C / 73°F)	approx. 60 min.
Movie recording time (continuous shooting)	approx. 100 min.
Playback time*	approx. 4 hr.

* Time when playing back a slideshow of still images

Interface

Wired

Digital terminal Micro USB
HDMI OUT terminal Type D

Wireless

Bluetooth
Compliance standards Bluetooth Ver. 4.1
(Bluetooth low energy technology)

Wi-Fi

Compliance standards IEEE802.11n/g/b
Transmission frequency
Frequency 2.4 GHz
Channels 1-11ch
Security
Infrastructure mode WPA2-PSK (AES/TKIP),
WPA-PSK (AES/TKIP), WEP
* Wi-Fi Protected Setup compliant
Camera access point mode WPA2-PSK (AES)

Operating Environment

Temperature Min. 0 °C, Max. 40 °C
(Min. 32 °F, Max. 104 °F)

Dimensions (CIPA compliant)

W approx. 110.1 mm (4.33 in.)

H approx. 63.8 mm (2.51 in.)

D approx. 39.9 mm (1.57 in.)

Weight (CIPA compliant)

Including Battery Pack,

Memory Card approx. 299 g (approx. 10.5 oz.)

Camera Body Only approx. 275 g (approx. 9.7 oz.)

Before Use

Basic Guide

Advanced Guide

Camera Basics

Auto Mode /
Hybrid Auto Mode

Other Shooting Modes

P Mode

Tv, Av, and M Mode

Playback

Wireless Features

Setting Menu

Accessories

Appendix

Index



Battery Pack NB-13L

Type:	Rechargeable lithium-ion battery
Nominal Voltage:	3.6 V DC
Nominal Capacity:	1250 mAh
Charging Cycles:	Approx. 300 times
Operating Temperatures:	0 – 40 °C (32 – 104 °F)

Battery Charger CB-2LH/CB-2LHE

Rated Input:	100 – 240 V AC (50/60 Hz) 0.09 A (100 V) – 0.06 A (240 V)
Rated Output:	4.2 V DC, 0.7 A
Charging Time:	Approx. 2 hr. 10 min. (when using NB-13L)
Operating Temperatures:	5 – 40 °C (41 – 104 °F)

Compact Power Adapter CA-DC30/CA-DC30E

Rated Input:	100 – 240 V AC (50/60 Hz) 0.07 A (100 V) – 0.045 A (240 V)
Rated Output:	5.0 V DC, 0.55 A
Charging Time:	Approx. 2 hr. 50 min.* (when charged with NB-13L in the camera) * Charging time varies considerably depending on the remaining battery level.
Operating Temperatures:	5 – 40 °C (41 – 104 °F)

Before Use

Basic Guide

Advanced Guide

Camera Basics

Auto Mode /
Hybrid Auto Mode

Other Shooting Modes

P Mode

Tv, Av, and M Mode

Playback

Wireless Features

Setting Menu

Accessories

Appendix

Index



Index

A

Accessories 107
AE lock 52
AF lock 60
AF method 57
Aspect ratio 34
Auto mode (shooting mode) 18, 26
Av (shooting mode) 65

B

Battery pack
 Charging 15
 Eco mode 101
 Level 119
 Power saving 101
Beep 100
Bluetooth 83

C

Camera Connect 83
CANON IMAGE GATEWAY 94
Color (white balance) 54
Continuous shooting 34
Custom white balance 54

D

Date/time/zone
 Settings 16
Defaults → Resetting
Digital tele-converter 57
Digital zoom 30
Display language 17
DPOF 113

E

Eco mode 101
Editing
 Red-eye correction 79
Editing or erasing connection
 information 98
Erasing 74
Error messages 118
Exposure

F

 AE lock 52
 Compensation 52
 FE lock 62
FE lock 62
File numbering 103
Fireworks (shooting mode) 42
Fish-eye effect (shooting mode) 44
Flash
 Flash exposure compensation 62
 Flash off 61
 Flash on 61
 Slow synchro 61
Focusing

G

 AF lock 60
 AF method 57
 MF peaking 57
 Servo AF 59
Focus range
 Macro 56
 Manual focus 56
Framing assist 31

G

Geotagging images 87
GPS information display 69
Grainy B/W (shooting mode) 43
Grid display 35

H

Handheld night scene (shooting mode) 41
HDMI cable 108

I

Image quality 35
Images
 Display period 38
 Erasing 74
 Playback → Viewing
 Protecting 72
Indicator 25, 37, 38
ISO speed 53

M

M (shooting mode) 65
Macro (focus range) 56
Magnified display 71
Manual focus (focus range) 56
Memory cards 2
Menu
 Basic operations 23
Metering method 52
Miniature effect (shooting mode) 46
Movies
 Editing 79

P

P (shooting mode) 51
Package contents 2
Photobook set-up 115
Playback → Viewing
Portrait (shooting mode) 41
Power 107 → Battery charger
 → Battery pack
Power saving 101
Printing 112
Program AE 51
Protecting 72

Q

Quick Control
 Basic operations 23

R

Rating 77
Red-eye correction 79
Reset camera 105
Resetting 105
Resizing images 77
Rotating 76

S

Saving images to a computer 112
Screen
 Display language 17
 Icons 119, 120
 Menu → Quick Control, Menu
SD/SDHC/SDXC memory cards
 → Memory cards
Searching 70
Self portrait (shooting mode) 40
Self-timer 33
Sending images 94

Before Use

Basic Guide

Advanced Guide

Camera Basics

Auto Mode / Hybrid Auto Mode

Other Shooting Modes

P Mode

Tv, Av, and M Mode

Playback

Wireless Features

Setting Menu

Accessories

Appendix

Index

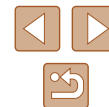

Sending images to a smartphone 83
Sending images to Web services 94
Servo AF 59
Shooting
 Shooting date/time → Date/time/
 zone
 Shooting information 119
Slideshow 72
Smooth skin (shooting mode) 43
Soft focus (shooting mode) 44
Software
 Saving images to a computer
 112
Strap 2, 14

T

Terminal 112
Toy camera effect (shooting mode)
 46
Tracking AF 58
Troubleshooting 116
TV display 108
Tv (shooting mode) 64

V

Viewing 19
 Image search 70
 Index display 70
 Magnified display 71
 Single-image display 19
 Slideshow 72
 TV display 108

W

White balance (color) 54
Wi-Fi features 83
Wind filter 48
Wrist strap → Strap

Z

Zoom 27, 30

Before Use
Basic Guide
Advanced Guide
Camera Basics
Auto Mode / Hybrid Auto Mode
Other Shooting Modes
P Mode
Tv, Av, and M Mode
Playback
Wireless Features
Setting Menu
Accessories
Appendix
Index



■ Precautions for Wireless Features

- Before goods or technologies in the camera regulated by the Foreign Exchange and Foreign Trade Act are exported (which includes bringing them outside Japan or showing them to non-residents in Japan), export or service transaction permission may be required from the Japanese government.
- Because this product includes American encryption items, it falls under U.S. Export Administration Regulations, and cannot be exported to or brought into a country under U.S. trade embargo.
- Be sure to make notes of the Wi-Fi settings you use. The wireless settings saved to this product may change or be erased due to incorrect operation of the product, the effects of radio waves or static electricity, or accident or malfunction. Please note that Canon accepts no responsibility for direct or indirect damages or loss of earnings resulting from a degradation or disappearance of content.
- When transferring ownership, disposing of the product, or sending it for repair, restore the default wireless settings by erasing any settings you have entered.
- Canon will not make compensation for damages resulting from loss or theft of the product. Canon accepts no responsibility for damages or loss resulting from unauthorized access or use of target devices registered on this product due to loss or theft of the product.
- Be sure to use the product as directed in this guide. Be sure to use the wireless function of this product within the guidelines noted in this guide. Canon accepts no responsibility for damages or loss if the function and product are used in ways other than as described in this guide.

Security Precautions

Because Wi-Fi uses radio waves to transmit signals, security precautions more stringent than when using a LAN cable are required. Keep the following points in mind when using Wi-Fi.

- Only use networks you are authorized to use. This product searches for Wi-Fi networks in the vicinity and displays the results on the screen. Networks you are not authorized to use (unknown networks) may also be displayed. However, attempting to connect to or using such networks could be regarded as unauthorized access. Be sure to use only networks you are authorized to use, and do not attempt to connect to other unknown networks.

If security settings have not been properly set, the following problems may occur.

- Transmission monitoring
Third parties with malicious intent may monitor Wi-Fi transmissions and attempt to acquire the data you are sending.
- Unauthorized network access
Third parties with malicious intent may gain unauthorized access to the network you are using to steal, modify, or destroy information. Additionally, you could fall victim to other types of unauthorized access such as impersonation (where someone assumes an identity to gain access to unauthorized information) or springboard attacks (where someone gains unauthorized access to your network as a springboard to cover their tracks when infiltrating other systems).

To prevent these types of problems from occurring, be sure to thoroughly secure your Wi-Fi network.

Only use this camera's Wi-Fi function with a proper understanding of Wi-Fi security, and balance risk and convenience when adjusting security settings.

Before Use
Basic Guide
Advanced Guide
Camera Basics
Auto Mode / Hybrid Auto Mode
Other Shooting Modes
P Mode
Tv, Av, and M Mode
Playback
Wireless Features
Setting Menu
Accessories
Appendix
Index

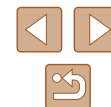

Third-Party Software

- AES-128 Library
Copyright (c) 1998-2008, Brian Gladman, Worcester, UK. All rights reserved.

LICENSE TERMS

The redistribution and use of this software (with or without changes) is allowed without the payment of fees or royalties provided that:

1. source code distributions include the above copyright notice, this list of conditions and the following disclaimer;
2. binary distributions include the above copyright notice, this list of conditions and the following disclaimer in their documentation;
3. the name of the copyright holder is not used to endorse products built using this software without specific written permission.

DISCLAIMER

This software is provided 'as is' with no explicit or implied warranties in respect of its properties, including, but not limited to, correctness and/or fitness for purpose.

- CMSIS Core header files
Copyright (C) 2009-2015 ARM Limited.
All rights reserved.

Redistribution and use in source and binary forms, with or without modification, are permitted provided that the following conditions are met:

- Redistributions of source code must retain the above copyright notice, this list of conditions and the following disclaimer.
- Redistributions in binary form must reproduce the above copyright notice, this list of conditions and the following disclaimer in the documentation and/or other materials provided with the distribution.
- Neither the name of ARM nor the names of its contributors may be used to endorse or promote products derived from this software without specific prior written permission.

THIS SOFTWARE IS PROVIDED BY THE COPYRIGHT HOLDERS AND CONTRIBUTORS "AS IS" AND ANY EXPRESS OR IMPLIED WARRANTIES, INCLUDING, BUT NOT LIMITED TO, THE IMPLIED WARRANTIES OF MERCHANTABILITY AND FITNESS FOR A PARTICULAR PURPOSE ARE DISCLAIMED. IN NO EVENT SHALL COPYRIGHT HOLDERS AND CONTRIBUTORS BE LIABLE FOR ANY DIRECT, INDIRECT, INCIDENTAL, SPECIAL, EXEMPLARY, OR CONSEQUENTIAL DAMAGES (INCLUDING, BUT NOT LIMITED TO, PROCUREMENT OF SUBSTITUTE GOODS OR SERVICES; LOSS OF USE, DATA, OR PROFITS; OR BUSINESS INTERRUPTION) HOWEVER CAUSED AND ON ANY THEORY OF LIABILITY, WHETHER IN CONTRACT, STRICT LIABILITY, OR TORT (INCLUDING NEGLIGENCE OR OTHERWISE) ARISING IN ANY WAY OUT OF THE USE OF THIS SOFTWARE, EVEN IF ADVISED OF THE POSSIBILITY OF SUCH DAMAGE.

Before Use
Basic Guide
Advanced Guide
Camera Basics
Auto Mode / Hybrid Auto Mode
Other Shooting Modes
P Mode
Tv, Av, and M Mode
Playback
Wireless Features
Setting Menu
Accessories
Appendix
Index

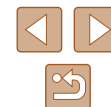

- KSDK Peripheral Drivers, Flash / NVM, KSDK H/W Abstraction Layer (HAL)
(c) Copyright 2010-2015 Freescale Semiconductor, Inc.
ALL RIGHTS RESERVED.

Redistribution and use in source and binary forms, with or without modification, are permitted provided that the following conditions are met:

- * Redistributions of source code must retain the above copyright notice, this list of conditions and the following disclaimer.
- * Redistributions in binary form must reproduce the above copyright notice, this list of conditions and the following disclaimer in the documentation and/or other materials provided with the distribution.
- * Neither the name of the <organization> nor the names of its contributors may be used to endorse or promote products derived from this software without specific prior written permission.

THIS SOFTWARE IS PROVIDED BY THE COPYRIGHT HOLDERS AND CONTRIBUTORS "AS IS" AND ANY EXPRESS OR IMPLIED WARRANTIES, INCLUDING, BUT NOT LIMITED TO, THE IMPLIED WARRANTIES OF MERCHANTABILITY AND FITNESS FOR A PARTICULAR PURPOSE ARE DISCLAIMED. IN NO EVENT SHALL <COPYRIGHT HOLDER> BE LIABLE FOR ANY DIRECT, INDIRECT, INCIDENTAL, SPECIAL, EXEMPLARY, OR CONSEQUENTIAL DAMAGES (INCLUDING, BUT NOT LIMITED TO, PROCUREMENT OF SUBSTITUTE GOODS OR SERVICES; LOSS OF USE, DATA, OR PROFITS; OR BUSINESS INTERRUPTION) HOWEVER CAUSED AND ON ANY THEORY OF LIABILITY, WHETHER IN CONTRACT, STRICT LIABILITY, OR TORT (INCLUDING NEGLIGENCE OR OTHERWISE) ARISING IN ANY WAY OUT OF THE USE OF THIS SOFTWARE, EVEN IF ADVISED OF THE POSSIBILITY OF SUCH DAMAGE.

Personal Information and Security Precautions

If personal information and/or Wi-Fi security settings, such as passwords, etc., are saved on the camera, please be aware that such information and settings may still remain in the camera.

When transferring the camera to another person, disposing of it, or sending it for repair, be sure to take the following measures to prevent the leakage of such information and settings.

- Erase registered Wi-Fi security information by choosing [Clear settings] in the Wi-Fi settings.

Trademarks and Licensing

- Microsoft and Windows are trademarks or registered trademarks of Microsoft Corporation in the United States and/or other countries.
- Macintosh and Mac OS are trademarks of Apple Inc., registered in the U.S. and other countries.
- App Store, iPhone, and iPad are trademarks of Apple Inc.
- The SDXC logo is a trademark of SD-3C, LLC.
- HDMI, the HDMI logo and High-Definition Multimedia Interface are trademarks or registered trademarks of HDMI Licensing, LLC.
- Wi-Fi®, Wi-Fi Alliance®, WPA™, WPA2™ and Wi-Fi Protected Setup™ are trademarks or registered trademarks of the Wi-Fi Alliance.
- The Bluetooth® word mark and logos are registered trademarks owned by Bluetooth SIG, Inc. and any use of such marks by Canon Inc. is under license. Other trademarks and trade names are those of their respective owners.
- All other trademarks are the property of their respective owners.
- This device incorporates exFAT technology licensed from Microsoft.
- This product is licensed under AT&T patents for the MPEG-4 standard and may be used for encoding MPEG-4 compliant video and/or decoding MPEG-4 compliant video that was encoded only (1) for a personal and non-commercial purpose or (2) by a video provider licensed under the AT&T patents to provide MPEG-4 compliant video. No license is granted or implied for any other use for MPEG-4 standard.

Before Use
Basic Guide
Advanced Guide
Camera Basics
Auto Mode / Hybrid Auto Mode
Other Shooting Modes
P Mode
Tv, Av, and M Mode
Playback
Wireless Features
Setting Menu
Accessories
Appendix
Index

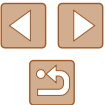

■ Disclaimer

- Unauthorized reproduction of this guide is prohibited.
- All measurements based on Canon testing standards.
- Information subject to change without notice, as are product specifications and appearance.
- Illustrations and screenshots in this guide may differ slightly from the actual equipment.
- The above items notwithstanding, Canon cannot be held liable for any loss arising from the use of this product.

Before Use

Basic Guide

Advanced Guide

Camera Basics

Auto Mode /
Hybrid Auto Mode

Other Shooting Modes

P Mode

Tv, Av, and M Mode

Playback

Wireless Features

Setting Menu

Accessories

Appendix

Index

