

OLYMPUS

PT-059

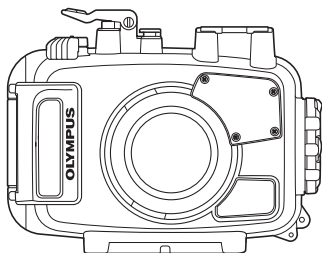

JP	取扱説明書	2
EN	Instruction Manual	30
FR	Mode d'emploi	58
ES	Manual de Instrucciones	86
DE	Bedienungsanleitung	114
PL	Instrukcja obsługi	142
RU	Инструкция по эксплуатации	174
CHT	使用說明書	206
KR	사용설명서	234

- Thank you for purchasing our product.
- Please read this instruction manual carefully and use the product safely and correctly. Please keep this instruction manual for reference after reading it.
- Wrong use may cause damage to the camera inside the Case due to water leakage, and repair may not be possible.
- Before use, perform an advance check as described in this manual.

Introduction

- Unauthorized copying of this manual in part or in full, except for private use, is prohibited. Unauthorized reproduction is strictly prohibited.
- OLYMPUS CORPORATION shall not be responsible in any way for lost profits or any claims by third parties in case of any damage occurring from improper use of this product.

EN



Please read the following items before use

This Case is a precision device designed for use at a water depth within 45 m. Please handle it with sufficient care.

- Please use the Case correctly after sufficient understanding of the contents of this manual in regard to handling of the Case, checks before use, maintenance, and storage after use.
- OLYMPUS CORPORATION shall in no way be responsible for accidents involving immersion of a digital camera in water. In addition, expenses incurred for damage of internal materials or loss of recorded contents due to water entering the camera will not be compensated. Please address these possible damages by insuring your camera at your own discretion before use.
- OLYMPUS CORPORATION shall not pay any compensation for accidents (injuries or material damage) at the time of use.

For safe use

This instruction manual uses various pictographs for correct use of the product and to prevent danger to the user and other persons as well as property damage. These pictographs and their meanings are shown below.

 WARNING	This shows the content regarding assumption of possibility of human death or severe injury in case of handling with disregard of this indication.
 CAUTION	This shows the contents regarding assumption of possibility of injury or damage to property in case of handling with disregard of this indication.

WARNING

- ① Keep this product out of the reach of babies, infants, and children. There is the possibility of occurrence of the following types of accidents.
 - Injury by dropping onto the body from a height.
 - Injury from parts of the body getting caught in parts which open and close.
 - Swallowing of small parts, O-ring, silicone grease and silica gel. Please consult a physician immediately if any parts have been swallowed.
 - Triggering of the flash in front of the eyes may cause permanent vision impairment etc.
- ② Do not store with a battery in the digital camera housed in this product. Storage with a battery inserted may lead to leakage of the battery liquid and fire.
- ③ If leakage of water should occur with a camera installed in this product, quickly remove the battery from the camera. There is the possibility of ignition and explosion from generation of hydrogen gas.
- ④ This product is made of resin. There is the possibility that injuries may be caused when it becomes broken because of strong impact with a rock or other hard objects. Please handle it with sufficient care.

CAUTION

- ① Do not disassemble or modify this product. This may cause water leakage or defect. In case of the loss of image data caused by disassembly, repair or modification etc. by any party other than those appointed by OLYMPUS CORPORATION, we shall bear no responsibility for damage.
- ② Use or storage of the product at the following locations may cause defective operation, trouble, damage, fire, internal clouding, or water leakage. This should be avoided.
 - Locations reaching high temperatures such as those under direct sunlight, in an automobile, etc.
 - Locations close to fire
 - Water depths in excess of 45 m
 - Locations subject to vibrations
 - Locations with high temperature and humidity or with severe temperature changes
 - Locations with volatile substances
- ③ Opening and closing at locations with much sand, dust, or dirt may impair the waterproof characteristic and cause water leakage. This should be avoided.
- ④ This product is not a case to soften impacts to the camera inside the product. When this product with a digital camera inside it is subjected to impacts or heavy objects are placed onto it, the digital camera may become damaged. Please handle it with sufficient care.
- ⑤ Do not use the following chemicals for cleaning, corrosion prevention, prevention of fogging, repair or other purposes. When these are used for the Case directly or indirectly (with the chemicals in vaporized state), they may cause cracking under high pressure or other problems.

Chemicals which cannot be used	Explanation
Volatile organic solvents, chemical detergents	Do not clean the Case with alcohol, gasoline, thinner or other volatile organic solvents or with chemical detergents etc. Use pure water or lukewarm water.
Anticorrosion agent	Do not use anticorrosion agents. The metal parts use stainless steel or brass. Wash with pure water.
Commercial defogging agents	Do not use commercial defogging agents. Always use the specified desiccant silica gel.
Grease other than specified silicone grease	Use only the specified silicone grease for the silicone O-ring, as otherwise the O-ring surface may deteriorate and water leakage may occur.
Adhesive	Do not use adhesive for repairs or other purposes. When repair is required, please contact a dealer or a service station of OLYMPUS CORPORATION.

- ⑥ Jumping into the water with the Case in your pocket or in your hand, throwing the Case from a boat or ship into the water, and other rough handling may cause water leakage. Please handle with sufficient care, when handing it over from hand to hand etc.
- ⑦ If the Case interior or the camera should become wet because of water leakage, etc., immediately wipe off all moisture and contact your local service station or dealer.
- ⑧ Please remove the O-ring when traveling by air. Otherwise air pressure may make it impossible to open the Case.
- ⑨ For safe use of the digital camera in this product, please read the "Instruction Manual" for the digital camera carefully.
- ⑩ When sealing this product, take sufficient care that no foreign matter gets caught at the O-ring and the contact surface. It is caused for water leakage.
- ⑪ When you install your digital camera in the Case after taking pictures in the water, it may cause the loss of transparency of the lens inside even if you insert the supplied silica gel to the Case when drying the camera is insufficient.

Contents

Introduction.....	30
Please read the following items before use.....	30
For safe use.....	31
1. Preparations.....	36
Check the contents of the package.....	36
Names of the parts.....	37
Using the accessories.....	39
Install the hand strap.....	39
Installation and removal of the monitor hood.....	40
Mounting and removing the lens cap.....	40
Prepare the digital camera.....	41
Attach the antireflective ring to the digital camera.....	41
2. Advance check of the Case.....	42
Advance check before use.....	42
Remove the O-ring.....	42
Remove any sand, dirt, etc.....	43
How to Apply Grease to the O-ring.....	43
Install the O-ring.....	44
3. Install the digital camera.....	45
Open the Case.....	45
Load the digital camera.....	46
Make sure the camera is loaded properly.....	47
Seal the Case.....	48
Check the operation of the loaded camera.....	48
Waterproofness test.....	49
4. Connecting the underwater flash.....	50
5. Taking Pictures Under Water.....	52
Underwater shooting modes.....	52
How to select the shooting scene.....	53
Locking AF during underwater shooting.....	53

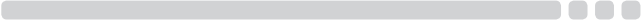

6. Handling After Shooting	54
Wash the Case with pure water	54
Wipe off any waterdrop	54
Take out the digital camera	55
Dry the Case	55
7. Maintaining the Waterproof Function	56
Remove the O-ring	56
Remove any sand, dirt, etc	56
How to Apply Grease to the O-ring	56
Install the O-ring	56
Replace consumable parts	56
8. Appendix	57
Specifications	57

1. Preparations

Check the contents of the package

Check that all accessories are in the box.

Contact your dealer if accessories are missing or damaged.

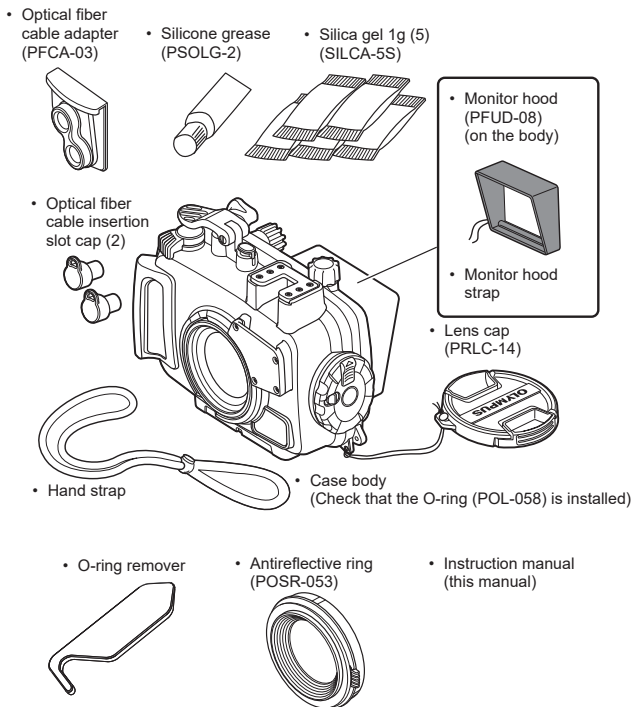

After purchase, be sure to do maintenance even in brand-new condition. Neglecting the maintenance may become the cause of water leakage.
For how to maintenance the case, refer to P.56.

Names of the parts

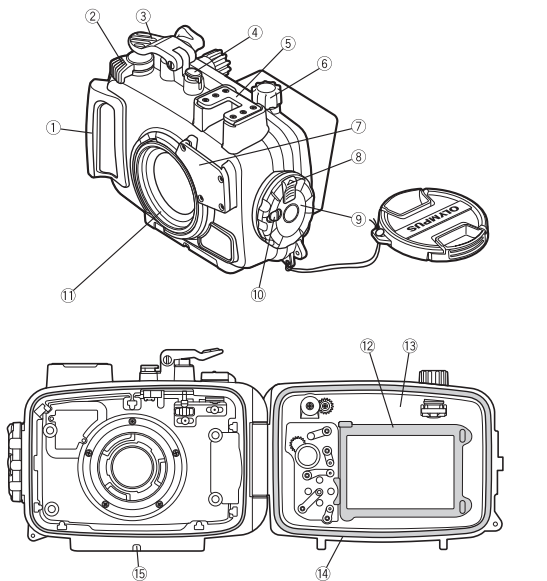

- ① Palm grip
- * ② Zoom lever
- * ③ Shutter button
- * ④ ON/OFF button
- ⑤ Accessory mount

- * ⑥ LOG lever
- ⑦ Diffuser
- ⑧ Slide lock
- ⑨ Open/close dial
- ⑩ Lock knob

- ⑪ Lens ring
- ⑫ Monitor inner hood
- ⑬ Rear lid
- ⑭ O-ring
- ⑮ Tripod seat

EN

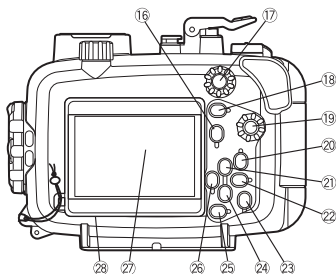

- | | | |
|--|--------------------------------------|--|
| * 16 INFO button | * 21 button/Arrow pad ▲ | * 25 MENU button |
| * 17 Control dial | * 22 button/Arrow pad ► | * 26 Mode function call button/Arrow pad ◀ |
| * 18 (Movie) button/
Select button | * 23 OK/AFL button (*1) | * 27 Monitor window |
| * 19 Mode dial | * 24 button/ button/
Arrow pad ▼ | * 28 Monitor hood |
| * 20 (Play) button | | |

EN

(*1) During Underwater Snap, Underwater Wide-Angle, Underwater-Macro, Underwater HDR shooting mode or Underwater Microscope the OK/AFL button functions as the AF LOCK button (P.53).

Memo:

The Case operation parts marked by * correspond to the operation parts of the digital camera. When the operation parts of the Case are operated, the corresponding functions of the digital camera will operate. For details of the functions, refer to the instruction manual for the digital camera.

Using the accesories

Install the hand strap

Install the hand strap on the Case body.

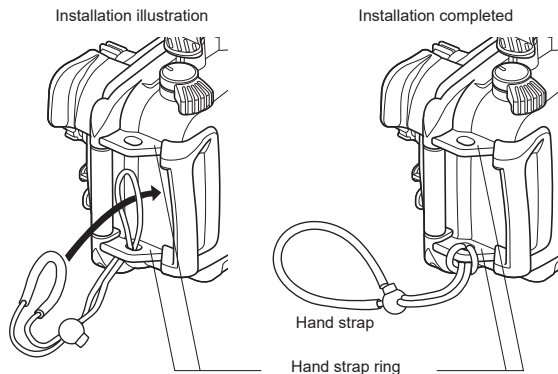

You can also attach the strap on the upper hand strap ring of the Case.

How to use the hand strap

Pass your hand through the hand strap and adjust the length with the stop button.

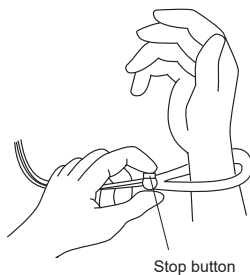



Installation and removal of the monitor hood

Installation

Fit the monitor hood as shown in the figure into the guides above and below the monitor window one after the other.

Removal

Remove the monitor hood from the guides above and below the monitor window one after the other by widening the monitor hood.



Guides

EN

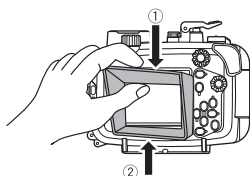

Installation

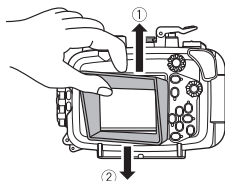

Removal

Mounting and removing the lens cap

Fit the lens cap onto the lens ring as shown in the figure. Be sure to remove the lens cap before shooting.

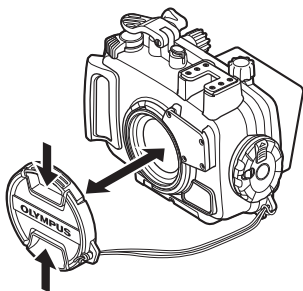

Prepare the digital camera

Prepare the digital camera before loading it in the Case.

1. Battery Confirmation

It is impossible to change the batteries when using the Case. Make sure that you have sufficient remaining battery capacity before use.

2. Confirmation of the Remaining Number of Pictures to be Taken

Confirm that the image storage has a sufficient remaining number of pictures to be taken.

3. Remove the hand strap from the digital camera.

When a digital camera is loaded without removing the hand strap, the hand strap may get caught between the Case lids and may cause water leakage.

Attach the antireflective ring to the digital camera

Remove the lens ring while pressing the lens ring release button from the digital camera, then attach the antireflective ring.

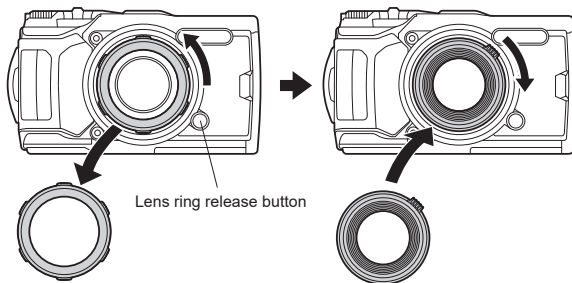

Change the digital camera setting when using the underwater wide conversion lens (PTWC-01).

Press the OK button to display the live control, then select "PTWC-01" under "Accessory Settings" with arrow pads or control dial. Then press the OK button.

* Even if the setting has been changed, the four corners of the image may be darkened when the zoom is used.

For details, see the instruction manual of the digital camera.

2. Advance check of the Case

Advance check before use

Depending on the carrying and storage conditions, the maintenance status, etc., the waterproof function may be damaged.

Before using, always perform the following advance checks.

If the advance test should show water leakage with normal handling, stop using the Case and contact your dealer or an Olympus service station.

Remove the O-ring

Open the Case and remove the O-ring.

Procedure

- ① Insert the O-ring remover into the gap between the O-ring and O-ring groove wall.
- ② Bring the tip of the inserted O-ring remover below the O-ring. (Be careful not to damage the groove with the tip of the O-ring remover.)
- ③ Lift the O-ring, pinch it with your fingertips and pull it out of the Case.

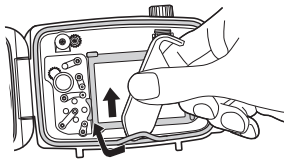



Remove any sand, dirt, etc.

After visually checking that dirt has been removed from the O-ring, check for attached sand and other foreign matter, as well as for damage and cracks by squeezing the entire circumference of the O-ring lightly with your fingertips.

Remove attached foreign matter from the O-ring groove with a lint-free clean cloth or a cotton swab. Also remove any sand or dirt attached to any part of the Case that comes into contact with the O-ring.

- When a sharp object is used to remove the O-ring or to clean the inside of the O-ring groove, the Case and the O-ring may be damaged and water leakage may be caused.
- When the O-ring is checked with the fingertips, take care not to stretch the O-ring.
- Never use alcohol, thinner, benzene or similar solvents or chemicals detergents to clean the O-ring. When such chemicals are used, it is likely that the O-ring will be damaged or that its deterioration will be accelerated.

How to Apply Grease to the O-ring

1	Apply the exclusive lubricant to the O-ring		Make sure that your fingers and the O-ring are free of dirt, then squeeze the appropriate amount of exclusive lubricant onto a finger to spread onto the entire circumference of the O-ring (approx. 15 mm is adequate).
2	Spread the lubricant all over the O-ring.		Apply the lubricant with 3 fingers and spread it over the O-ring. Be careful not to use force as this may stretch the O-ring.
3	Check that the O-ring is free of scratches or unevenness.		After spreading the lubricant, check visually and by touch that the O-ring is not scratched and that its surface is flat. If it is damaged in any way, be sure to replace it with a brand-new O-ring.

- Always perform maintenance of the waterproof function even when the Case has been opened every shooting. Neglecting this maintenance may cause water leakage.
- When the Case is not to be used for a long time, remove the O-ring from the groove to prevent deformation of the O-ring, apply a thin coat of silicone grease, and store it in a clean plastic bag or the like.



Examples of foreign matter sticking to the O-ring



Hair



Fibers



Grains of sand

Install the O-ring

Confirm that no foreign matter is in the groove and then fit the O-ring. At this time, confirm that the O-ring does not stick out from the groove.

When sealing this product, make sure that no hairs, fibers, sand particles or other foreign matter stick not only to the O-ring, but also to the contact surface (front lid). Even a single hair or a single grain of sand may cause water leakage. Please check with special care.

EN

3. Install the digital camera

Open the Case

- ① Slide the lock knob towards the arrow direction (1 of figure below).
- ② Slide and hold the slide lock towards the arrow direction (2 of figure below) and turn the open/close dial counter clockwise (3 of figure below).
- ③ Turn the open/close dial to the position where it cannot be turned further.
- ④ Open the rear lid of the Case gently.

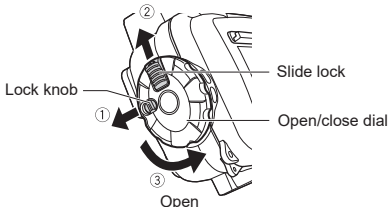

Do not exert too much force while turning the open/close dial. Doing so may damage the dial.

Load the digital camera

- ① Confirm that the digital camera is OFF.
- ② Confirm that the LOG lever of the digital camera is set to the OFF side.
- ③ Gently and straightly insert the digital camera into the Case.
- ④ Insert 2 piling up silica gel bags (1 g) between the bottom of the digital camera and the Case.
The silica gel bags are provided for prevention of fogging.

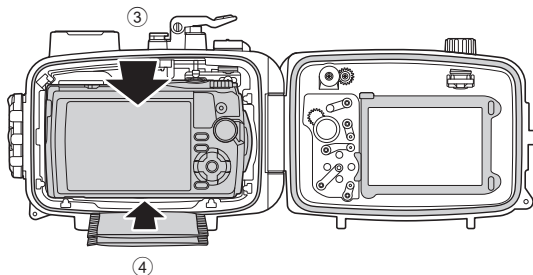

EN

- If the silica gel bag is caught when the Case is sealed, water leakage will occur.
- Once silica gel has been used, the moisture absorption performance will be impaired. Always replace the silica gel when the Case is opened and closed.
- Clean the surface of the dials of the Case and the camera.
The dials may slip if there is grease or foreign matter on them.



Make sure the camera is loaded properly

Check the following points before sealing the Case.

- Is the digital camera loaded properly?
- Are silica gel bags inserted all the way?
When the silica gel bags are not inserted correctly, it causes entrapment when closing the rear lid.
- Is the grease applied to O-ring?
- Is the O-ring attached properly to the opening on the Case?
- Is there any dirt or foreign matter on the O-ring or the O-ring contact surface on the front lid?



Seal the Case

- ① Set the LOG lever to the OFF side.
- ② Close the Case gently while aligning the mounting projection of the rear lid and groove.
- ③ Turn the open/close dial clockwise until you hear a “click” sound to lock the Case.
 - The Case is sealed.
- ④ Slide the lock knob towards the LOCK side.

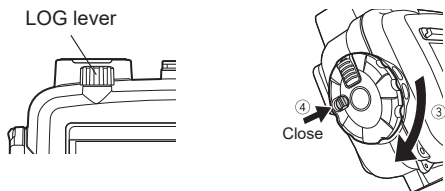

EN

- If the open/close dial is not fully turned, the Case will not be sealed. This will cause water leakage.
- Close the rear lid of the Case so that the lens cap and LCD hood straps do not get caught. If the straps are caught, water leaks may result.

Check the operation of the loaded camera

After sealing the Case, check that the camera operates normally.

- Operate the ON/OFF button on the Case and confirm that the camera turns ON/OFF.
- Press the shutter button on the Case and confirm that the camera shutter releases.
- Also operate other control buttons on the Case and confirm that the camera functions properly.

Waterproofness test

The final test after loading the camera is explained below. Always perform this test. It can be performed easily in a water tank or a bathtub. Confirm the operation of the different buttons. The required time is about 5 minutes.

- At first, immerse the Case for only 3 seconds and check that no water enters the Case.
- Next, immerse the Case for 30 seconds and check that no water drop etc. has entered the Case.
- Then, immerse the Case for 3 minutes, operate all buttons and levers, and check the following:
 - check that no water has entered the Case.
 - check that the Case is not clouded.
 - check that no water drop has entered the Case.
- If the inside of the Case becomes fogged or there are water drops in the Case, repeat the maintenance of the O-ring (P.43) and perform the waterproofness test again.

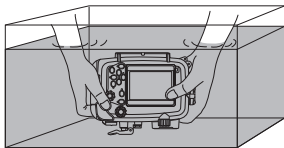

4. Connecting the underwater flash

To connect the underwater flash (optional) to the Case using an underwater optical fiber cable (optional: PTCB-E02), follow the procedures below.

How to install

- ① Attach the optical fiber cable adapter to the diffuser shown in the figure below.

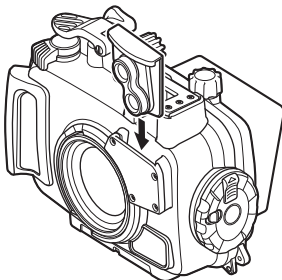

- ② Put the underwater optical fiber cable plug all the way into the insertion slot of the optical fiber cable adapter until the black axis of the connector is hidden.

When using two underwater flashes

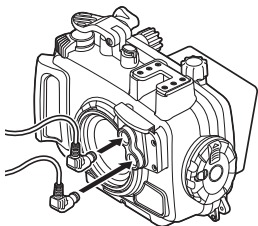

When using an underwater flash

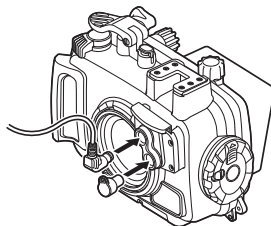

Put the cap to the optical fiber cable insertion slot when not in use.



Setting of the digital camera

When using the underwater flash supporting wireless RC flash, set the camera and the underwater flash to RC mode. For details, refer to the instruction manuals of the camera and the flash.

In case of UFL-1, plug the optical fiber cable in the same way. Set the RC mode of the camera to OFF.

5. Taking Pictures Under Water

Camera GPS, electronic compass, temperature sensor and pressure sensor do not work properly when using Case.

Underwater shooting modes

For details, refer to the instruction manuals of the digital camera.

Underwater Snapshot

Suitable for shooting seaside and pool portraits.

Underwater Wide

Suitable for shooting underwater.

Underwater Macro

Suitable for shooting close-up view underwater.

Underwater HDR

Suitable for contrasting underwater scenes.

This mode captures multiple images and merges them into one, properly exposed image.

Underwater Microscope

Suitable for shooting ultra close-up view underwater.

When taking macro pictures on the wide-angle and if getting too close to the subject, the flash light may be missing in some parts of the picture or the light volume may not be uniform.

During underwater shooting, shooting conditions (water clarity, suspended matter, etc.) can have a significant effect on the range of the flash.

Always check your pictures on the LCD monitor after shooting.

How to select the shooting scene

- ① Turn the mode dial, and then set the camera's shooting mode to "👁️".
- ② Press the left/right arrow pad or control dial to select the sub mode, and then press the OK/AFL button.

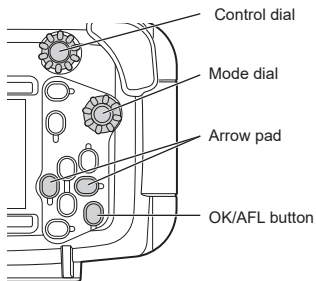

Locking AF during underwater shooting

When the "Underwater Snapshot", "Underwater Wide", "Underwater Macro", "Underwater HDR" or "Underwater Microscope" is selected, you can easily lock the focus position (AF lock operation) by pressing the OK/AFL button while pressing the shutter button halfway. When the focus is locked, the AF lock indicator appears on the monitor screen of the camera. To cancel the AF lock, press the OK/AFL button again.

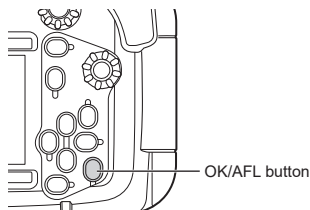

EN

6. Handling After Shooting

Wash the Case with pure water

- ① After use, clean the protector thoroughly with pure water as soon as possible.

Fill a water tank or bathtub with pure water, shake the Case in the water a number of times, and then remove all the sand and gravel particles adhering around the open/close dial, the buttons and the levers.

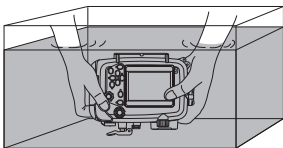

After use in sea water, soak it in pure water for a fixed time (30 minutes to an hour) to remove any salt.

- ② Operate the shutter button and various buttons of the product in pure water to clean and remove the salt attached to the shaft.
- ③ Take it out of the water and rinse with pure water.

- Do not disassemble for cleaning.
- Drying the Case with salt adhered may impair the function. Always wash off any salt after use.

Wipe off any waterdrop

Remove any drops of water from the Case. Use air or a soft cloth not leaving any fibers to thoroughly wipe any waterdrop from the joint between the front and rear lid, the palm grip, the open/close dial and other operating parts.

When waterdrops remain between the front and the rear lid, they may spill to the inside when the Case is opened. Take special care to wipe off all waterdrops.



Take out the digital camera

Open the Case carefully and take the digital camera out.

- When opening the Case, take sufficient care that no water will drip from your hair or body onto the Case and the camera.
- Before opening the Case, make sure that your hands or gloves are free of sand, fibers, etc.
- Do not open or close the Case at locations where there is water spray or sand.
- Take care not to touch the digital camera or the battery with hands wet with sea water.

Dry the Case

After washing with pure water, use a clean cloth to wipe off any waterdrops. Be sure to use a soft, dry cloth free of salt residue that does not leave any loose fibers. Dry the Case completely at a well ventilated location in the shade.

- Do not use hot air from a hair dryer or the like for drying and do not expose the Case to direct sunlight, as this may accelerate deterioration and deformation of the Case and deterioration of the O-ring, leading to leakage of water.
- When wiping the Case, take care not to cause scratches.

EN

7. Maintaining the Waterproof Function

The O-ring is a consumable product. Before each use, perform proper maintenance. Always be sure to perform the O-ring maintenance operation as described below. Neglecting this maintenance may become the cause of water leakage.

Perform at the location without sand or dust, after washing and drying your hands.

Remove the O-ring

Refer to P.42.

Remove any sand, dirt, etc.

Refer to P.43.

EN How to Apply Grease to the O-ring

Refer to P.43.

Install the O-ring

Refer to P.44.

Replace consumable parts

- The O-ring is a consumable product. Independent of the number of times the Case is used, it is recommended that the O-ring should be replaced by a new piece after a year has passed.
- Deterioration of the O-ring is accelerated by the use conditions and the storage conditions. Replace the O-ring even before a year has passed if it shows signs of damage, crack or loss of elasticity.

- Please use genuine Olympus silicone grease, silica gel and O-ring.
- Do not try to replace the O-ring by yourself.
- We recommend to perform the check periodically.

8. Appendix

Specifications

Compatible models	Olympus digital camera OLYMPUS Tough TG-6
Pressure resistance	Depth of up to 45 m
Main materials	Body: Polycarbonate Lens window: Glass (Double sided multiple coat / water repellent coat)
Operating environment	0°C - 40°C (32°F - 104°F) (operation) / -20°C - 60°C (-4°F - 140°F) (storage)
Dimensions	Approx. 157 mm (Width) x 122 mm (Height) x 81 mm (Depth)
Weight	Approx. 484 g (camera and accessories not included)
Weight under water	Approx. 13 g (in the freshwater) (camera, batteries and media card included)

* We reserve the right to change the external appearance and the specifications without notice.

Sold separately accessories

Silicone grease: PSOLG-3
Optical fiber cable: PTCB-E02
Underwater flash: UFL-3
O-ring: POL-058

Short arm: PTSA-02,
PTSA-03
Maintenance kit: PMS-02
O-ring remover (2): PTAC-05
Balance weight: PWT-1BA
PWT-1AD

Technical Support (U.S.A. / Canada)

24/7 online automated help: <http://www.olympusamerica.com/support>

Phone customer support: Tel. 1-800-260-1625 (Toll-free)

Our phone customer support is available from 9 am to 9 pm (Monday to Friday) ET

E-Mail: distec@olympus.com

European Technical Customer Support

Please visit our homepage

<http://www.olympus-europa.com>

or call: Tel. 00800 - 67 10 83 00 (Toll-free)

+49 40 - 237 73 899 (Charged)

EN

date of issue 2019.03.

OLYMPUS[®]
