

KV-FL1 Full-Spectrum Flash User's Manual

Thank you purchasing this speedlite.

Please read this manual carefully before using your full-spectrum flash!

Safety instructions:

1. Never trigger the speedlite around flammable gas or liquid gas in the vicinity (such as gasoline and solvents).
2. Never shoot with this speedlite at moving cars or other motorists.
3. Never trigger the speedlite at close range directly at eyes.
4. Only use the batteries listed in this manual.
5. Never place the batteries in high-temperature environment, such as in the sun or near an open flame.
6. Remove drained batteries from the speedlite. Alkaline liquid leaking from the battery will damage the speedlite.
7. Do not attempt to recharge non-rechargeable batteries.
8. Protect the speedlite under extremely hot or damp environments.
9. Do not put the speedlite in a glove box of a car dashboard. When triggering the speedlite, never put any reflective items immediately in front of or on the reflection shield. Keep the surface of the bulb clean.
10. Do not touch the speedlite after continuous triggering.
11. Do not attempt to modify or disassemble this flash.
12. During continuous shooting under optical output, flash must rest 15 minutes every 10 continuous flashes.
13. Rapid change of temperature will cause vapor condensation.

The Speedlite Features

1. TTL flash
2. Manual flash
3. Multi flash
4. Wireless master function: C version support Canon wireless trigger, N version support Nikon wireless trigger.
5. Wireless slave unit function: Compatibility with the Canon and Nikon wireless flash system, TTL, manual, and frequency flash
6. S1 & S2 Mode
7. High-Speed Sync 1/8000s
8. Rear-curtain Sync
9. Voice prompt
10. Custom function
11. Power save mode
13. Overheating protection
14. Automatic save function
15. LCD display
16. Manual, Auto zoom function
17. Quick response Full output recycle time only 2.9 second
18. Support high speed continuous shooting: In 1/16 brightness and below.
19. Up to 12EPS high speed continuous shooting.

Flash Parts/Terms

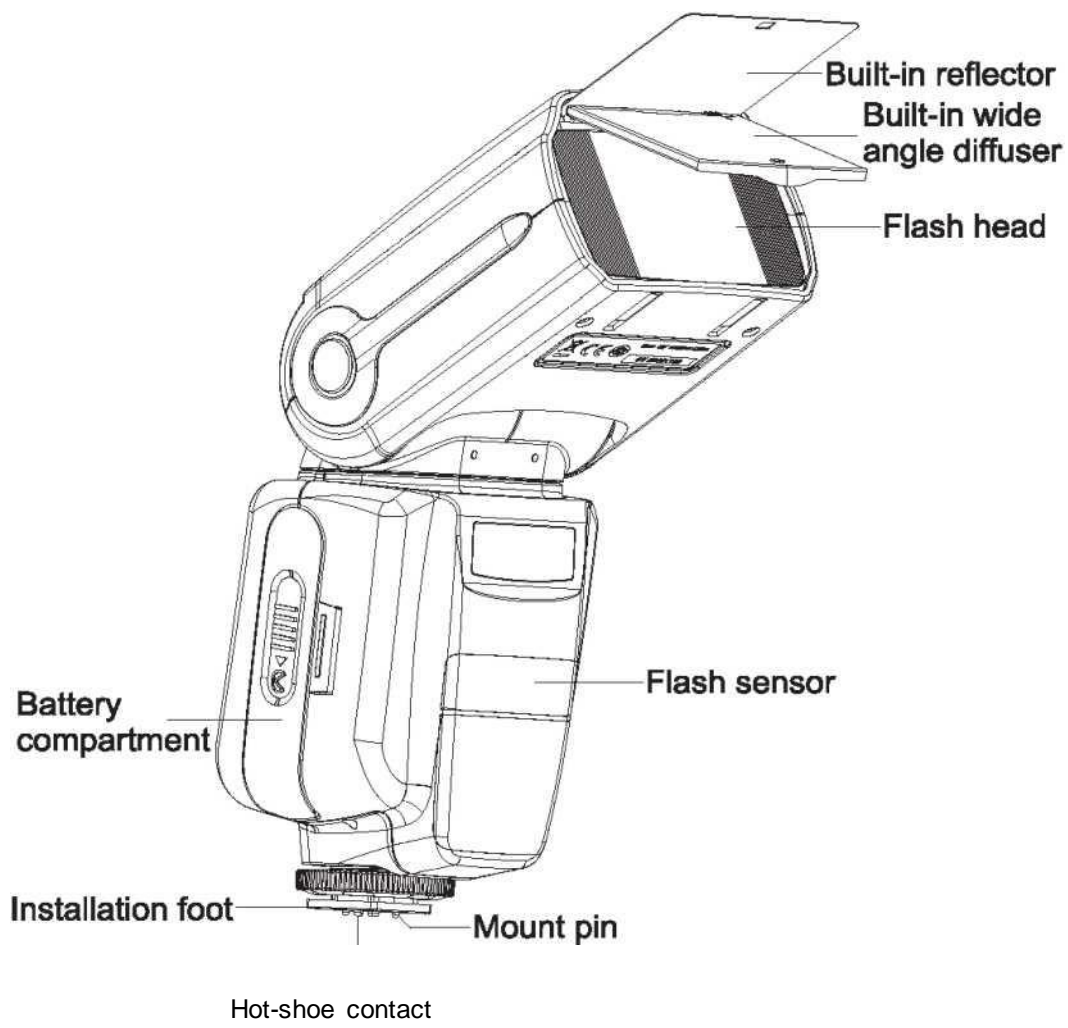

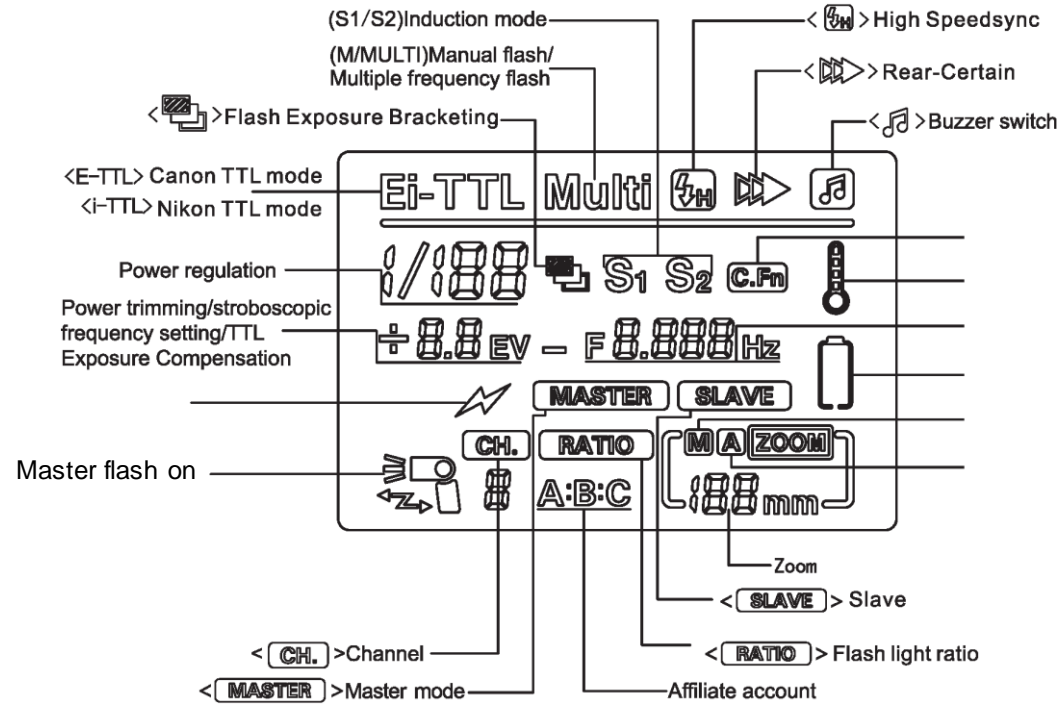

Auto-focus auxiliary AF assist lamp

When using the flash in lower light situations, the red automatic AF assist light may temporarily project red light to assist auto-focusing. This can be disabled in your camera's menu or by focusing manually.

Set the Bounce Direction

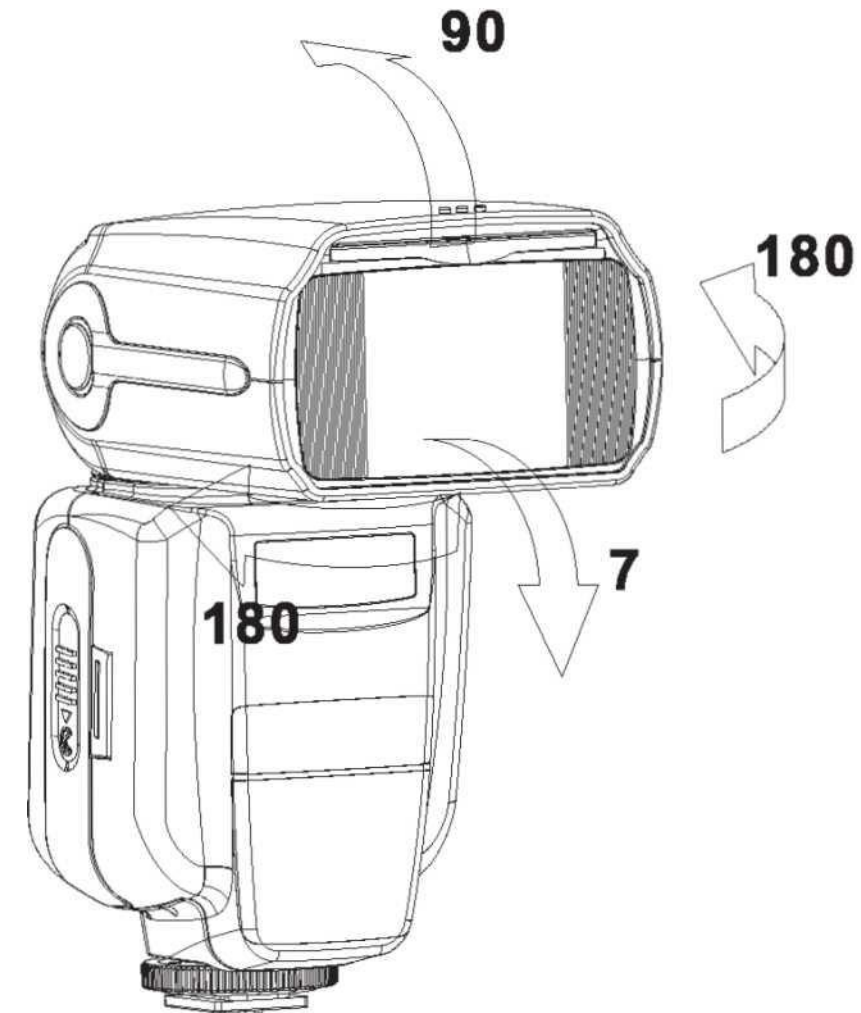

This speedlite can tilt 90 degrees vertically (Up and Down) and rotate 180 degrees horizontal (Left and Right). Rotating the speedlite to point toward ceilings or walls can 'bounce' light toward the subject to make the image appear more natural.

Basic Operation

Installing the batteries:

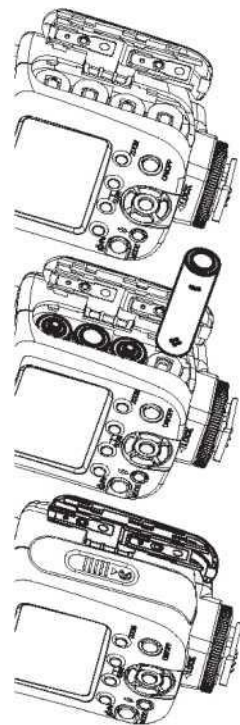

1. Open the cover.
Slide the battery door according to the direction of the arrow (down), then open it.

2. Install the batteries.
Insert four (4) AA batteries according to the [+] and [-] signs on the battery door cover. Make sure the battery 'positive' and 'negative' contacts are correctly oriented.

3. Close the cover.
Slide the battery door back up into the closed position.

Compatible battery types:

Every battery below is useable with this speedlite.

- A. 4 (AA) alkaline manganese battery (1.5V). The battery can meet medium power demand and does not need maintenance, but it can not be recharged.
- B. 4 (AA) nickel-cadmium battery (1.2V). The battery recycles quickly and can be recharged, so it is economic.
- C. 4 (AA) nickel-metal hydride batteries (1.2V). This battery's power exceeds that of nickel-cadmium battery and it is less harmful to the environment (do not contain cadmium).
- D. 4 (AA) lithium battery (1.5V). This battery has large capacity, low of self-discharge rate, and no need for maintenance.
- E. 4 (AA) hydrogen oxygen cell (1.5V). This battery is also called (OXYRIDE). Its

capacity is larger and its service life is about 1.5 times that of alkaline batteries. It is commonly used in electronic products with high power consumption.

When using external an acceleration power box, battery box, or power pack, please put 4 (AA) batteries into the speedlite to supply the CPU. Do not store this flash for extended durations (more than several weeks) with batteries installed.

Attaching to the camera

1. Prepare to attach the speedlite by rotating the locking plate counter-clockwise up to the highest point.

2. Install the flash
Slide the flash's mounting support into the hot shoe of camera.

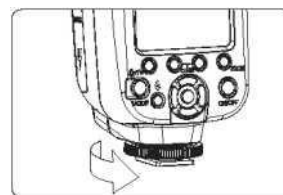

3. Lock the speedlite:
Tighten the locking plate by rotating clockwise as the marked "LOCK" arrow points.

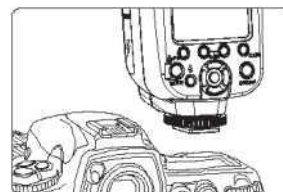

4. Detach the speedlite:
Rotating the locking plate counter-clockwise up to the highest point, then detach the speedlite from the hot shoe.

- Note: Make sure the speedlite and camera are turned off.

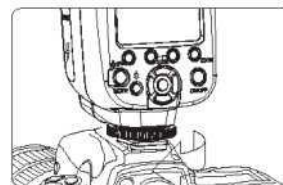

- Do not forcibly pull the flash from the hotshoe while it is in locked position.

Power on the Flash

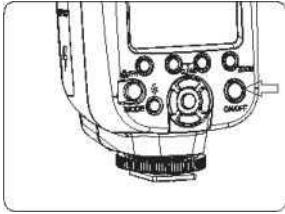

Press the Power button (ON/OFF) for two seconds to turn the flash on or off.

In order to save battery power and avoid battery leakage, the default system settings will

operate as follows:

When the speedlite is not in use for 60 seconds, the CPU will automatically enter Sleep. In this case, press any key to “wake up” the speedlite. When the speedlite is not in use for more than 30 minutes, the CPU will shut down automatically.

If the speedlite is not in use for a long period time, it is recommended to use the main power switch to turn the speedlite off and remove the power source (4x AA batteries). Before removing the batteries, use the Power Button to turn the speedlite OFF.

When the speedlite capacitor is fully charged, the speedlite PILOT button will light up blue indicating that the flash is ready to fire.

State of charge indicator

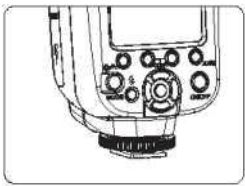

Before shooting, confirm that the flash charging indicator light and camera viewfinder light have both been lit. If neither lights are on, the flash will not fire.

Extended Interface

You can connect to an external power supply and/or connect to PC synchronization via the port on the left side of the flash.

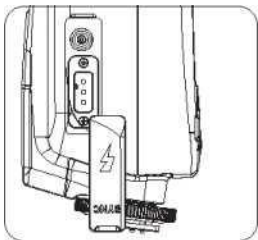

1. The external power connector can provide more adequate power than AA batteries.
2. To connect with PC sync, make sure camera and speedlite are synchronized.

TTL Flash

Set the camera's shooting mode to <P> (Program automatic exposure) or <A> (Auto). Your Flash will now sync with your camera's automatic exposure settings and adjust power accordingly for the correct exposure.

Setting the flash exposure compensation value:

1. Select the flash mode

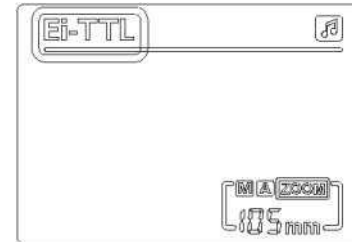

2. Press “MODE” button until the LCD displays “TTL”. Set the flash exposure compensation value. Press the “UP” and “DOWN” keys to adjust exposure compensation.

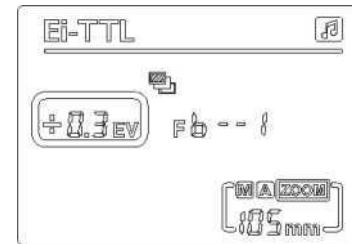

1. Select the “Right” and “Left” keys to adjust exposure value.

2. The available compensation value is adjusted in increments of ‘+’ or ‘-’ 0.3 .OEV.

The compensation value icon:

0EV: +0.3EV, +0.7EV, +1.0EV, +1.3EV—+1
-0.3EV, -0.7EV, -1.0EV, -1.3EV—+1.

Using E-TTL and Autoflash in the shooting Modes

Setting your camera's shooting mode to Aperture Priority (A, Av), Shutter Priority (S,Tv), or Manual (M) will also enable you to use E-TTL/ i-TTL autofocus.

<p>TV S</p>	<p>Select this mode when you want to set the shutter speed manually. The camera will then automatically set aperture according to the shutter speed to obtain a standard exposure. If the aperture display blinks, it means that the background exposure will be underexposed or overexposed. Adjust the shutter speed until the aperture display stops blinking.</p>
<p>NA</p>	<p>Select this mode when you want to set the aperture manually. The camera will then automatically set the shutter speed matching the aperture to obtain a standard exposure. If the background is dark, like in a night scene, a slow sync speed will be used to obtain a standard exposure of both the main subject and background. Standard exposure of the main subject is obtained with the flash, while a standard exposure of the background is obtained with a slow shutter speed. Since a slow shutter speed will be used for low-light scenes, using a tripod is recommended. If the shutter speed display blinks, it means that the background exposure will be underexposed or overexposed. Adjust the aperture until the shutter speed display stops blinking.</p>

If you use the <DEP> or <A-DEP> shooting mode, the result will be the same as using the <P>(ProgramAE) mode.

<p>M</p>	<p>Select this mode if you want to set both the shutter speed and aperture manually. Standard exposure of the main subject is obtained with the flash. The exposure of the background is obtained with the shutter speed and aperture combination you set.</p>
-----------------	--

Flash Sync Speeds and Apertures Used

	Shutter Speed Setting	Aperture Setting
<p>P</p>	<p>Set automatically (1/60 sec.~1/Xsec.)</p>	<p>Automatic</p>
<p>TV/S</p>	<p>Set manually (30 sec.~1/Xsec.)</p>	<p>Automatic</p>
<p>AV/A</p>	<p>Set automatically (30 sec.~1/Xsec.)</p>	<p>Manual</p>
<p>M</p>	<p>Set manually (buLb,30 sec.~1/Xsec.)</p>	<p>Manual</p>

1/X sec. is the cameras maximum flash sync speed.

FEB Setting Value (Canon version)

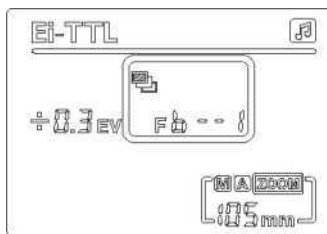

You can take three flash shots while automatically changing the flash output for each shot up to ± 3 stops in 1/3-stop increments (1/2-stops increments if the camera enables only 1/2-stop increments). This is called FEB (Flash Exposure Bracketing). For FEB, set the camera's drive mode to "single shot" before shooting to ensure that

the flash is ready.

Press the [Up] or [Down] keys from the main navigation buttons to set the desired exposure bracketing value.

1. Press the [Up] key to increase bracketing exposure value.
- Press the [Down] key to decrease bracketing exposure value.
2. The FEB has a full range of 0-3.0.

The FEB icon:

0 | 0. 3 | 0. 7 | 1. 0 | 1. 3 | 1. 7 | 2. 0 | 2. 3 | 2. 7 | 3. 0

FEL: Flash exposure lock

FEL (Flash Exposure Lock) locks the correct flash exposure setting for any selected part of the scene. With <TTL> displayed on the LCD panel, press the camera's <FEL> button. If the camera does not have an <FEL> button, press the <AEL> button. With Nikon cameras, press the "FV" button. If the camera supports Flash Exposure Lock, connect the flash screen under TTL mode. You can also set the flash brightness on-camera. After applying this setting, the speedlite will fire a "preflash". The camera will then detect the required output for the subject and save it. (this feature is primarily camera based. Please refer to your camera manual settings for more specific operating instructions).

Manual flash mode M

Manual Flash mode (M) allows you to set the brightness of the flash output power from 1/128 to 1/1 (full power). The flash output can be adjusted by 1/3 speed increments. You can also manually adjust the flash zoom by pressing the zoom button [ZOOM] to enter manual zoom.

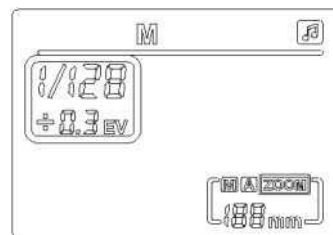

Select the flash mode:

Press the "MODE" button until the LCD displays "M".

Power setting:

1. Select the "Right" key on the main directional button pad to increase flash power.

Display will read: 1/128—1/64-1/32-...-1/1

2. Select the "Left" key to decrease flash power.

Displays will read: 1/1-1/2-1/4f ... 1/128

3. Select the up and down keys for fine tuning of the flash power in 0.3 EV increments.

Display will read:

UP: +0. 3EV —> +0. 7EV

DOWN: - 0. 3EV —> - 0. 7EV

Stroboscopic Flash Mode (Multi)

Using Multi mode, you can issue a series of quick flashes to shoot multiple images of moving objects on a photo. You can set the flash frequency (number of flashes per second can use Hz to show), the number of flashes and flash output. During repeated Multi mode, Single exposure create a strobe effect that imitates multiple exposures on a single frame. This mode is often used when shooting moving objects.

To prevent the flash head overheating damage, do not perform more than 10 consecutive strobe flash bursts. Between consecutive exposure operation, it is recommended to allow several minutes for cooling time. After 10 bursts, allow the flash to cool for at least 15 minutes. If you fire the flash in strobe burst mode more than 10 consecutive times with no pauses, the flash may automatically stop to prevent overheating of the flash head. If this happens, please allow the flash to cool for at least 15 minutes. Please use fresh or fully charged batteries to operate this mode.

Under Strobe mode (Multi), you can adjust flash power, time of flash, as well as frequency regulation.

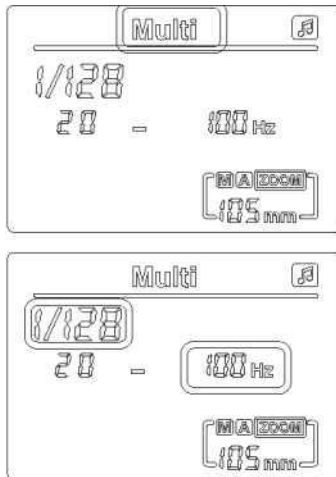

To select the flash mode Press [MODE] mode button until the LCD displays the mode seen here (Left).

Frequency setting

Select "Middle" key from the main navigation buttons to select the setting you wish to adjust. The selected setting value will blink or "flicker". Press "Left" and "Right" to set the frequency (Hz). The available flash frequency is 1HZ- 199HZ. After the value is set, press the "Middle" key again to confirm.

The number of flashes set

When the flash number is blinking, press "Left" and "Right" to set the number of flashes for the burst. The available number of flashes is 1-40. Select the "Middle" key again to select the desired number.

Exposure power setting

Repeat the previous steps to adjust the exposure setting in this mode. The power of the flash will be limited by the number of flashes in Multi mode (Multi). Refer to the table below for available flash power/number combinations.

Flash power and the number of flash relational tables						
Flash power	1-128	1-64	1-132	1-16	1-8	1-4
Flash number	1-40	1-20	1-12	1-8	1-4	1-2

[ZOOM] Zoom settings

L 嚙區飾飾

Press the "ZOOM" key to select the zoom setting for adjustment. It will blink when selected. Use the "Left" and "Right" keys to match this setting to your lens' focal length. Once the Zoom value is correct, press the "ZOOM" key again to confirm.

Available ZOOM settings are listed in the table below.

A	M	M	M	M	M	M	M	M	M	M
Automatic	18	24	28	35	50	70	85	105	135	180

Wireless flash mode

The Wireless flash system can be composed of multiple flashes with wireless flash functions. You can use a ordinary TTL auto flash to use multiple flashes simultaneously. Press “Wireless Select” key (Left “CLEAR” Key). The flash will be set wireless flash mode. The LCD will display “Master”. Press (wireless select) Key again. The flash will cycle through MASTER/SLAVE ‘C’/ SLAVE ‘N’/S1/S2 as well as Normal flash. “Master” flash operates as the master control unit that “Slave” flashes follow in a synchronized manner. Set the flash “Slave” to place it off camera and fire in synchronization with a main flash. TTL/ M/Multi. Slave C/Slave N/S1 / S2 can utilize slave units to create multiple flash lighting effects.

Wireless master mode (MASTER Canon)

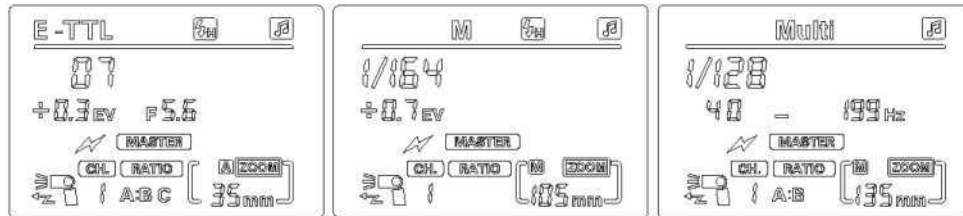

Pressing [wireless select] key until the LCD displays the master control mode “MASTER” seen above.

Wireless setting

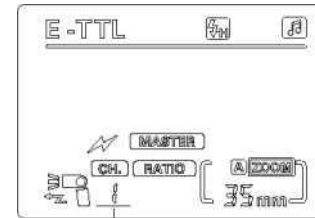

Wireless channel

Setting the master wireless channel:
Press the [wireless setting] key to channel number (number under CH icon) flicker. Press [left] [right] key to set wireless channel, the settable channels are 1~4.

Set master unit flash on/off:

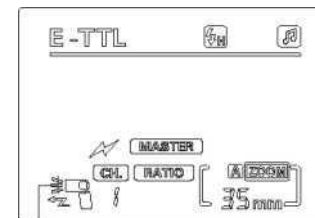

Master flash switch symbol

You can disable the master control unit flash so that only the flash slave unit will fire.

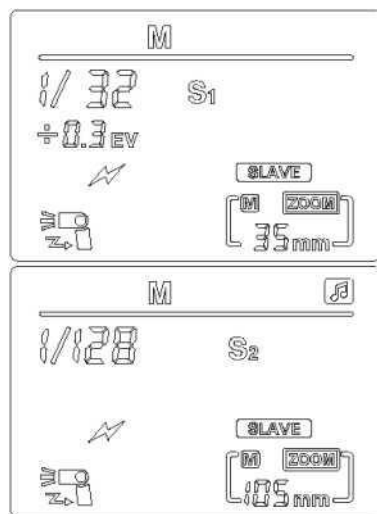

SI & S2 modes

1. Press the “Wireless Select” button until the LCD displays S1, S2.

- (1) Adjust exposure and fine tuning using the main navigations “Up”, “Down”, “Left”, and “Right” as described previously for Manual Mode.

2. S1 and S2 mode are compatible with manual flash mode and TTL flash mode. Operation for adjusting output brightness is identical to M mode in the S1 and S2 modes. Just press the “left” “right” “up” “down” and “middle” keys to change exposure and zoom.



S1 mode:

S1 mode will set the flash unit to be the first sync with the master flash and consistent output with the use of wireless slave functions. To use this mode properly, the master flash should be set to manual flash and should not use the TTL flash system, pre-flash function and the red-reduction function with multiple flashes.

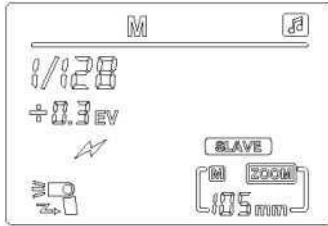

S2 mode:

S2 mode is also referred to as "pre-flash cancel mode". This mode is similar to S1 mode, but it can neglect the pre-flash given by TTL flash. Therefore, it can support the master flash and sync with your internal flash, you can try to use S2 mode. If the auxiliary lamp selection S1/S2 mode cannot properly synchronized with the master flash, make sure that the flash mode of the master flash is correct. Sensing modes and power output should be set correctly.

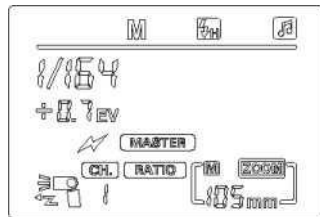

In order to avoid the following situations when use the S1/S2 mode: The Master speedlite using in the red-eye reduction function and modeling; The master speedlite using the remote flash mode (Nikon) or wireless flash mode (Canon.); Use ST-E2 as flash controller.

Note: When the flash in Slave mode, Mode key is invalid. This requires you to withdraw from the Slave mode so that can change the mode manually. When the Nikon version speedlite setting in the Slave mode, it can't connect with the camera. You will need to withdraw from Slave mode so that can connect.

High-speed sync with Rear-curtain sync settings

High-speed sync will allow the flash to sync with high shutter speeds. This is especially useful for outdoor portraits and scenes with other strong light sources.

Rear-curtain sync: With a slow shutter speed, you can create a light trail following the subject,

Bounce flash

When the flash head pointing to the wall or ceiling, the flash “bounced” off of these surfaces. This can reduce the shadows around the subject and get more natural and aesthetically pleasing lighting effects.

Sound prompts:

Different sounds will prompt the functions of the speedlite.

Long press the custom function setting button (Lightbulb/fn) to turn these sounds on or off.

1. A long beep: recycling done

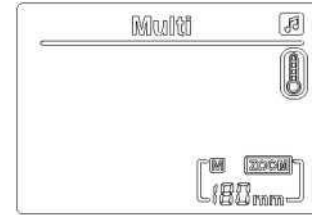

2. Two short beeps: flash ready after recycling
3. Two long beeps: recycling unfinished
4. Three short beeps: 30minuts without operation, auto turn-off or shut down.
5. Four short beeps: no function, battery power is low (recycling timeout)

Backlight display

1. Press the LCD backlight key once to turn on the display light (lightbulb/fn key). Press the LCD backlight key again to turn the light off.

Custom function settings

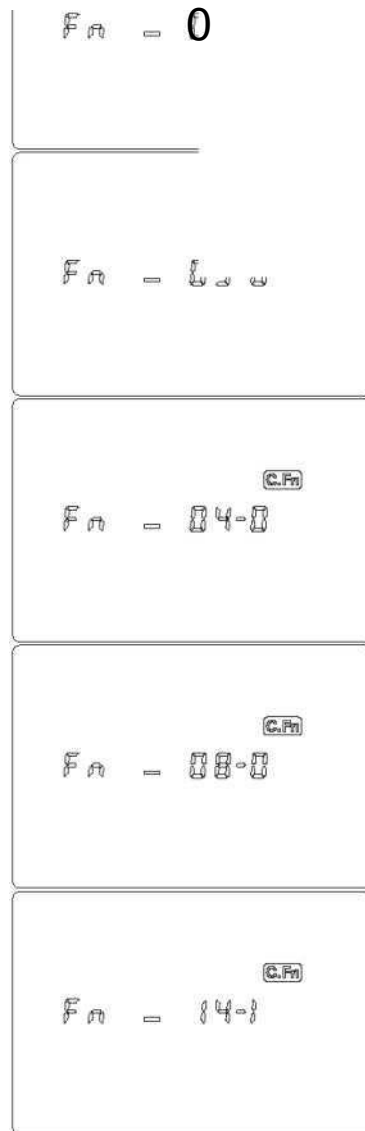

You can set the flash according to your preferences in the custom function menu.

Press the "custom function setting button" (lightbulb/Fn) shown on the left.

Navigate the custom menu with the "Up" and "Down" keys.

Custom Function No.	Function	Set ID	Settings and descriptions
C.Fn-01	Auto power off	0	on
		1	off
C.Fn-03	Flash exposure bracketing auto cancel	0	on
		1	off
C.Fn-04	Flash exposure bracketing sequence	0	tjf +
		1	0 → +
C.Fn-08	Af-assist beam	0	on
		1	off
C.Fn-14	Buzzer switch	0	on
		1	off

Note: Fn number of 00 ~ 13 options can be accessed through the camera menu of "External flash custom function Settings" to set up; The Numbers for: 00,02,05,06, 07,09,10,11, 12,13 options are disabled.

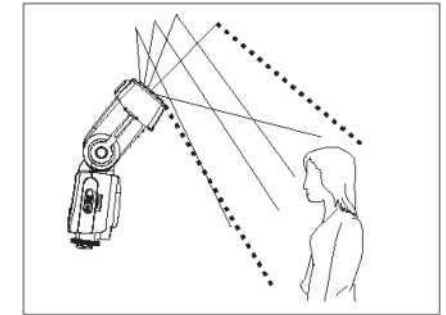
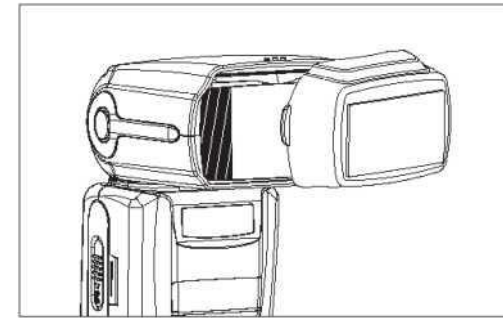

Using the IR & UV Filters

To filter your flash for a specific wavelength, simply attach the correctly labeled filter to the front of the flash head. Attaching the IR flash filter will block all visible and UV light, making your flash composed purely of Infrared light and invisible to the human eye. Attaching the UV flash filter will block all visible and IR light.

Warning: Though invisible, UV light can still be harmful to the eyes at high power and for prolonged exposure. Do not flash directly into eyes even with filters attached.

Using the built-in bounce card

Another bounce method is to extend the built-in reflection card.
subject.

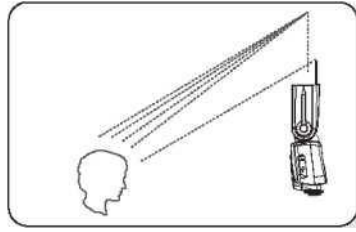

1. Rotating the head of flash light up to 90 degree.

2. Pull-out Card



3. Pull-in wide angle spread board and leave reflect board.

Using the built-in wide diffuse

When shooting at a distance less than 2 meters from the subject, you can use the built-in wide diffuser to shooting to get more natural lighting. This part is extended similar to the bounce card. The built-in wide flash diffuse can be extended to enable wide-angle coverage.

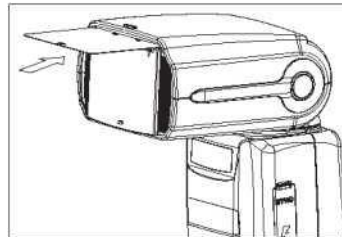
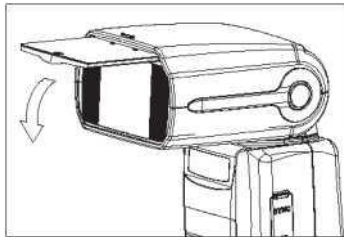

Specifications

Circuit design: Insulated Gate Bipolar Transistor(IGBT)

Flash index:58(ISO 100,180mm)

Flash coverage: 18~180mm

Manual, Automatic Zoom

Swinging/Tilting flash head (bounce flash)

Flash mode: TTL,M,FEB,Master^ Slave,S1 ,S2,Multi

The wireless trigger: Wireless induction flash lighting

The wireless cited flash distance: Indoor 20-30 meters,

Outdoor 10-15 meters

Up and down whirl angle degree: -7~90degree

Left and right whirl angle degree:0~ 180degree

Slave Group and Unit: 4 Slave communication channels (1,2,3,4)

3 Slave unit group(A,B,C)

Color temperature:5500K

Flash time: 1/200 seconds ~ 1/20000 seconds

Flash control: 1/128~1/1 step length is 0.3EMTotal 22 fine -tuning stalls.

Peripheral interface: Hot shoe, PC mount, External charge mount Recycle time:2.9 seconds

Power:4pcs AA alkaline cell or AANickel-Hydrogen (NI-MH) battery Lighting time: 100-1500 times

Additional function: PC synchronous, Sniff mode, Over temperature protection

Volume:200*75 *57mm

NetWeight:375g