

DIGITAL CAMERA

Z 9

Reference Guide

- The instructions in this document are for camera firmware version 3.00. The latest firmware is available from the Nikon Download Center.
- This camera features updated firmware with added functions.
 - Changes with "C" Firmware Version 4.00 (page 937)
 - Changes with "C" Firmware Version 4.10 (page 1030)

- Read this document thoroughly before using the camera.
- To ensure proper use of the camera, be sure to read "For Your Safety" (page 29).
- After reading this document, keep it readily accessible for future reference.

Table of Contents

Introduction	24
When Your First Photo Can't Wait.....	24
Getting Ready.....	24
Take and View Pictures.....	26
Package Contents.....	27
About This Document.....	28
Symbols.....	28
Conventions.....	28
For Your Safety.....	29
Notices.....	34
Getting to Know the Camera and Its Menus	37
Parts of the Camera.....	37
Camera Body.....	37
The Control Panel.....	46
The Monitor.....	47
The Viewfinder.....	51
Touch Controls.....	59
The Menus.....	65
The MENU Button.....	65
The i Button (the i Menu).....	72
First Steps	78
Attaching the Strap.....	78
Charging the Battery.....	79
The Battery Charger.....	79
The Charging AC Adapter: Charging.....	81
Inserting the Battery.....	83
Removing the Battery.....	84
Battery Level.....	85
Inserting Memory Cards.....	86
Removing Memory Cards.....	87

Attaching a Lens.	88
Detaching Lenses.	90
Camera Setup.	91
Basic Photography and Playback.	93
Taking Photographs.	93
Shooting Videos.	97
Playback.	100
Viewing Videos.	101
Deleting Unwanted Pictures.	103
Shooting Settings.	104
Image Recording Options (Image Area, Quality, and Size).	104
Adjusting Image Area Settings.	104
Adjusting Image Quality.	106
Adjusting Image Size Settings.	108
Focus.	110
Focus Mode.	110
AF-Area Mode.	112
Choosing a Subject Type for Autofocus.	116
Focus Point Selection.	119
The Touch Shutter.	120
Focus Lock.	122
Manual Focus.	124
Exposure.	127
Choosing a Shooting Mode.	127
Long Time-Exposures (Mode M Only).	132
Autoexposure Lock.	135
Exposure Compensation.	137
Release Mode.	139
Choosing a Release Mode.	139
High-Speed Frame Capture + (C30/C60/C120).	142
Using the Self-Timer (Ⓢ).	145
ISO Sensitivity.	147

About ISO Sensitivity.	147
Auto ISO Sensitivity Control.	149
White Balance.	151
About White Balance.	151
Fine-Tuning White Balance.	156
Choosing a Color Temperature.	161
Preset Manual.	165
Bracketing.	170
Auto Bracketing Set.	170
Exposure and Flash Bracketing.	171
White Balance Bracketing.	176
ADL Bracketing.	179
Picture Controls.	183
About Picture Controls.	183
Modifying Picture Controls.	185
Custom Picture Controls.	189
Location Data.	193
Location Data Options.	193
Two-Button Reset.	197
Photo Shooting Menu.	197
Video Recording Menu.	199
Custom Settings Menu.	200
Other Settings.	201
Video Recording.	202
Video File Types.	202
Tone Mode.	204
Video Frame Size and Rate Options.	205
Frame Size and Rate Options for RAW Video.	205
Frame Size and Rate Options for Other Video Formats.	206
Bit Rate.	208
Video Image Area Options.	212
Points to Note When Filming Videos.	215

RAW Video.	217
Recording HLG Video.	218
View Assist.	220
Recording N-Log Video.	221
View Assist.	222
Hi-Res Zoom.	223
Using Hi-Res Zoom.	223
Viewing and Retouching Pictures.	225
Viewing Pictures.	225
Full-Frame Playback.	225
Thumbnail Playback.	226
Photo Information.	228
Basic Information.	229
Exposure Data.	230
Highlight Display.	231
RGB Histogram.	231
Shooting Data.	233
Overview.	237
File Info.	239
The z Button (Playback Mode)	240
Photos.	240
Videos.	244
Videos (Playback Paused).	245
Playback Zoom.	246
Using Playback Zoom.	246
Protecting Pictures from Deletion.	248
Rating Pictures.	250
Selecting Pictures for Upload.	251
Filtered Playback.	252
[Filtered Playback Criteria].	252
Viewing Slide Shows.	254
During the Show.	255

Deleting Pictures.	256
Using the Delete Button.	256
Deleting Multiple Pictures.	257
Creating Retouched Copies.	260
RAW Processing.	263
Trim.	268
Resize.	269
D-Lighting.	273
Straighten.	273
Distortion Control.	274
Perspective Control.	275
Monochrome.	276
Overlay (Add).	277
“Lighten” and “Darken”.	279
Motion Blend.	283
Editing Videos.	285
Trimming Videos.	285
Saving Selected Frames as JPEG Stills.	289
Voice Memos.	292
Recording Voice Memos.	292
Playing Voice Memos.	294
Deleting Voice Memos.	294
Connecting to HDMI TVs and Recorders.	295
Connecting to HDMI Devices.	295
TVs.	296
Recorders.	297
Adjusting Settings.	297
YCbCr and Bit Depth.	301
HDMI Output and Tone Mode.	302
External Recording Control.	303
Connecting to Smart Devices.	304
The SnapBridge App.	304

What SnapBridge Can Do for You.	305
Wireless Connections.	306
Connecting via Bluetooth (Pairing).	306
Connecting via Wi-Fi (Wi-Fi Mode).	310
Connecting to Computers or FTP Servers.	313
Making the Connection.	313
Computers: Connecting via USB.	313
Computers: Connecting via Ethernet or Wireless LAN.	314
FTP Servers: Connecting via Ethernet or Wireless LAN.	315
Computers: Connecting via USB.	316
Installing NX Studio.	316
Copying Pictures to a Computer Using NX Studio.	317
Computers: Connecting via Ethernet or Wireless LAN.	320
What Ethernet and Wireless LAN Can Do for You.	320
The Wireless Transmitter Utility.	321
Wireless LAN.	322
Ethernet Connections.	335
Uploading Pictures.	340
Camera Control.	346
Ending the Connection to the Computer.	349
FTP Servers: Connecting via Ethernet or Wireless LAN.	350
Wireless LAN.	351
Ethernet.	368
Uploading Pictures.	375
Ending the Connection to the FTP Server.	381
Troubleshooting Wireless LAN and Ethernet Connections.	382
Problems and Solutions.	382
Error Codes.	383
Connecting to Other Cameras.	385
What Inter-camera Connections Can Do for You.	385
Camera-Based Remote Photography (Synchronized Release).	385
Clock Synchronization (Synchronize Date and Time).	385



Synchronized Release.	386
Configuring and Using Synchronized Release.	386
Synchronizing Camera Clocks.	402
Flash Photography.	403
“On-Camera” Versus “Remote”.	403
Camera-Mounted Flash Units.	403
Remote Flash Photography.	403
Using an On-Camera Flash.	404
Flash Control Mode.	407
Flash Modes.	409
Flash Compensation.	411
Adjusting Flash Compensation.	411
FV Lock.	412
Remote Flash Photography.	414
What Is Remote Flash Photography?.	414
Using Remote Flash Units.	414
Radio AWL.	415
Establishing a Wireless Connection.	415
Remote Flash Photography.	419
Adding a Shoe-Mounted Flash Unit.	425
Optical AWL.	426
Using Optical AWL with the SB-5000 or SB-500.	426
The Photo Shooting Menu: Shooting Options.	436
The Photo Shooting Menu.	436
Shooting Menu Bank.	439
Renaming Shooting Menu Banks.	440
Copying Shooting Menu Banks.	440
Restoring Default Settings.	440
Extended Menu Banks.	441
Storage Folder.	442
Renaming Folders.	442
Select Folder by Number.	443

Select Folder from List	444
File Naming	446
Role Played by Card in Slot 2	447
Deleting Copies	449
Image Area	450
Image Quality	451
Image Size Settings	452
RAW Recording	453
ISO Sensitivity Settings	454
White Balance	455
Set Picture Control	456
Manage Picture Control	457
Color Space	458
Active D-Lighting	459
Long Exposure NR	461
High ISO NR	462
Vignette Control	463
Diffraction Compensation	464
Auto Distortion Control	465
Photo Flicker Reduction	466
High-Frequency Flicker Reduction	468
Metering	470
Flash Control	471
Flash Control Mode	471
Wireless Flash Options	472
Remote Flash Control	473
Radio Remote Flash Info	473
Focus Mode	474
AF-Area Mode	475
AF Subject Detection Options	476
Vibration Reduction	477
Auto Bracketing	478

Multiple Exposure.	479
Creating a Multiple Exposure.	481
HDR Overlay.	487
Taking HDR Photographs.	488
Interval Timer Shooting.	492
Interval-Timer Photography.	494
Time-Lapse Video.	503
Recording Time-Lapse Videos.	505
Focus Shift Shooting.	514
Focus Shift Photography.	515
The Video Recording Menu: Video Recording Options.	522
Video Recording Menu.	522
Shooting Menu Bank.	524
Extended Menu Banks.	525
Storage Folder.	526
File Naming.	527
Destination.	528
Video File Type.	529
Frame Size/Frame Rate.	530
Video Quality (N-RAW).	531
Image Area.	532
Extended Oversampling.	533
ISO Sensitivity Settings.	534
White Balance.	535
Set Picture Control.	536
Manage Picture Control.	537
HLG Quality.	538
Active D-Lighting.	539
High ISO NR.	540
Vignette Control.	541
Diffraction Compensation.	542
Auto Distortion Control.	543

Video Flicker Reduction.	544
High-Frequency Flicker Reduction.	545
Metering.	546
Focus Mode.	547
AF-Area Mode.	548
AF Subject Detection Options.	549
Subject Detection.	549
AF When Subject Not Detected.	549
Vibration Reduction.	550
Electronic VR.	551
Microphone Sensitivity.	552
Attenuator.	553
Frequency Response.	554
Wind Noise Reduction.	555
Mic Jack Plug-in Power.	556
Headphone Volume.	557
Timecode.	558
"Reset Using Remote".	559
External Rec. Cntrl (HDMI).	560
Hi-Res Zoom.	561
Custom Settings: Fine-Tuning Camera Settings.	562
Custom Settings Menu.	562
Custom Settings Bank.	570
Renaming Custom Settings Banks.	570
Copying Custom Settings Banks.	570
Restoring Default Settings.	570
a1: AF-C Priority Selection.	571
a2: AF-S Priority Selection.	572
a3: Focus Tracking with Lock-On.	573
Blocked Shot AF Response.	573
Subject Motion.	573
a4: Focus Points Used.	574

a5: Store Points by Orientation.	575
a6: AF Activation.	577
a7: Focus Point Persistence.	578
a8: Limit AF-Area Mode Selection.	579
a9: Focus Mode Restrictions.	580
a10: Focus Point Wrap-Around.	581
a11: Focus Point Display.	582
Manual Focus Mode.	582
Dynamic-Area AF Assist.	582
AF-C In-Focus Display.	583
3D-Tracking Focus Point Color.	583
a12: Built-in AF-Assist Illuminator.	584
a13: Focus Peaking.	585
Focus Peaking Display.	585
Focus Peaking Sensitivity.	585
Focus Peaking Highlight Color.	585
a14: Focus Point Selection Speed.	586
a15: Manual Focus Ring in AF Mode.	587
b1: ISO sensitivity Step Value.	588
b2: EV Steps for Exposure Cntrl.	589
b3: Easy Exposure Compensation.	590
b4: Matrix Metering Face Detection.	591
b5: Center-Weighted Area.	592
b6: Fine-Tune Optimal Exposure.	593
b7: Keep Exp. When f/ Changes.	594
c1: Shutter-Release Button AE-L.	595
c2: Self-Timer.	596
c3: Power Off Delay.	597
d1: Continuous Shooting Speed.	598
d2: Maximum Shots per Burst.	599
d3: Limit Release Mode Selection.	600
d4: Pre-Release Capture Options.	601

d5: Sync. Release Mode Options.	603
d6: Extended Shutter Speeds (M).	604
d7: Limit Selectable Image Area.	605
d8: File Number Sequence.	606
d9: View Mode (Photo Lv).	608
d10: Starlight View (Photo Lv).	610
d11: Warm Display Colors.	611
d12: LCD Illumination.	612
d13: View All in Continuous Mode.	614
d14: Release Timing Indicator.	615
d15: Image Frame.	616
d16: Grid Type.	617
d17: Virtual Horizon Type.	618
Roll.	619
Pitch.	620
d18: Custom Monitor Shooting Display.	621
d19: Custom Viewfinder Shooting Display.	623
d20 High FPS Viewfinder Display.	624
e1: Flash Sync Speed.	625
e2: Flash Shutter Speed.	627
e3: Exposure Comp. for Flash.	628
e4: Auto  ISO Sensitivity Control.	629
e5: Modeling Flash.	630
e6: Auto Bracketing (Mode M).	631
e7: Bracketing Order.	632
e8: Flash Burst Priority.	633
f1: Customize  Menu.	634
View Memory Card Info.	636
Split-Screen Display Zoom.	636
f2: Custom Controls (Shooting).	637
Command Dials.	648
Saving and Recalling Focus Positions.	649

f3: Custom Controls (Playback)	654
Command Dials	658
f4: Control Lock	660
f5: Reverse Dial Rotation	661
f6: Release Button to Use Dial	662
f7: Reverse Indicators	663
f8: Reverse Ring for Focus	664
f9: Focus Ring Rotation Range	665
f10: Control Ring Response	666
f11: Switch Focus/Control Ring Roles	667
f12: Full-Frame Playback Flicks	668
Flick Up/Flick Down	668
Flick Advance Direction	669
f13: Prefer Sub-selector Center	670
g1: Customize ⓘ Menu	671
Multi-Selector Power Aperture	673
Multi Selector Exposure Comp.	673
View Video Info	673
g2: Custom Controls	674
Command Dials	682
g3: Control Lock	683
g4: Limit AF-Area Mode Selection	684
g5: Focus Mode Restrictions	685
g6: AF Speed	686
g7: AF Tracking Sensitivity	687
g8: Hi-Res Zoom Speed	688
g9: Fine ISO Control (Mode M)	689
g10: Extended Shutter Speeds (Mode M)	690
g11: View Assist	691
g12: Zebra Pattern	692
Pattern Tone Range	692
Pattern	692

Highlight Threshold.....	692
Mid-tone Range.....	693
g13: Limit Zebra Pattern Tone Range.....	694
g14: Grid Type.....	695
g15: Brightness Information Display.....	696
g16: Custom Monitor Shooting Display.....	697
g17: Custom Viewfinder Shooting Display.....	699
g18: Red REC Frame Indicator.....	700
The Playback Menu: Managing Pictures.....	701
Playback Menu.....	701
Delete.....	703
Playback Folder.....	704
Playback Display Options.....	705
Delete Pictures from Both Slots.....	707
Dual-Format Recording PB Slot.....	708
Filtered Playback Criteria.....	709
Series Playback.....	710
Sub-selector Displays First Shot.....	710
Auto Series Playback.....	710
List Series as Single Thumbnails.....	710
Picture Review.....	711
After Delete.....	712
After Burst, Show.....	713
Auto-Rotate Pictures.....	714
Copy Image(s).....	715
Copying Pictures.....	715
The Setup Menu: Camera Setup.....	721
Setup Menu.....	721
Format Memory Card.....	724
"Yes (Full Format)".....	725
Language.....	726
Time Zone and Date.....	727

Monitor Brightness.	728
Monitor Color Balance.	729
Viewfinder Brightness.	730
Viewfinder Color Balance.	731
Finder Display Size (Photo Lv).	732
Limit Monitor Mode Selection.	733
Auto Rotate Info Display.	734
AF Fine-Tuning Options.	735
Creating and Saving Fine-Tuning Values.	737
Choosing a Default Fine-Tuning Value.	738
Non-CPU Lens Data.	739
Save Focus Position.	740
Auto Temperature Cutout.	741
Sensor Shield Behavior at Power Off.	742
Clean Image Sensor.	743
Image Dust Off Ref Photo.	744
Acquiring Image Dust Off Reference Data.	744
Pixel Mapping.	746
Image Comment.	747
Input Comment.	747
Attach Comment.	747
Copyright Information.	748
Artist/Copyright.	748
Attach Copyright Information.	748
IPTC.	749
Creating, Renaming, Editing, and Copying Presets.	749
Deleting Presets.	749
Embedding Presets.	750
Copying Presets to a Memory Card.	750
Copying Presets to the Camera.	751
Voice Memo Options.	754
Voice Memo Control.	754

Audio Output (Playback).....	755
Camera Sounds.....	756
Shutter Sound.....	756
Beep On/Off.....	756
Volume.....	757
Pitch.....	757
Silent Mode.....	758
Touch Controls.....	759
Enable/Disable Touch Controls.....	759
Glove Mode.....	759
HDMI.....	760
USB Connection Priority.....	761
Location Data (Built-In).....	762
Wireless Remote (WR) Options.....	763
LED Lamp.....	763
Link Mode.....	764
Assign Remote (WR) Fn Button.....	765
Conformity Marking.....	766
Battery Info.....	767
USB Power Delivery.....	769
Energy Saving (Photo Mode).....	771
Slot Empty Release Lock.....	772
Save/Load Menu Settings.....	773
Save Menu Settings.....	776
Load Menu Settings.....	776
Reset All Settings.....	777
Firmware Version.....	778
The Network Menu: Network Connections.....	779
Network Menu.....	779
Airplane Mode.....	781
Wired LAN.....	782
Connect to Smart Device.....	783

Pairing (Bluetooth)	783
Select Pictures for Upload.	784
Wi-Fi connection.	785
Upload While Off.	786
Location Data (Smart Device).	786
Connect to Computer.	787
Network Settings.	787
Connection Type.	789
Options.	790
Connect to FTP Server.	792
Network Settings.	792
Options.	795
Connect to Other Cameras.	798
Synchronized Release.	798
Network Settings.	798
Group Name.	799
Master/Remote.	799
Remote Camera List.	799
Synchronize Date and Time.	799
ATOMOS AirGlu BT Options.	800
USB.	802
Start via LAN.	803
Router Frequency Band.	804
MAC Address.	805
My Menu/Recent Settings.	806
My Menu/Recent Settings.	806
My Menu: Creating a Custom Menu	807
Adding Items to My Menu.	807
Removing Items from My Menu.	809
Reordering Items in My Menu.	810
Displaying [RECENT SETTINGS].	811
Recent Settings: Accessing Recently-Used Settings.	812

How Items Are Added to [RECENT SETTINGS].	812
Troubleshooting.	813
Before Contacting Customer Support.	813
Problems and Solutions.	815
Battery/Display.	815
Shooting.	817
Playback.	822
Bluetooth and Wi-Fi (Wireless Networks).	824
Miscellaneous.	825
Alerts and Error Messages.	826
Alerts.	826
Error Messages.	829
Technical Notes.	832
Compatible Lenses and Accessories.	832
Camera Displays.	833
The Monitor.	833
The Viewfinder.	840
The Control Panel.	843
Compatible Flash Units.	846
The Nikon Creative Lighting System (CLS).	846
Features Available with CLS-Compatible Flash Units.	846
Notes on Optional Flash Units.	874
Compatible Accessories.	878
Calibrating Batteries.	887
Attaching a Power Connector and AC Adapter.	889
Software.	891
Caring for the Camera.	893
Long-Term Storage.	893
Cleaning.	893
Image Sensor Cleaning.	894
Manual Cleaning.	896
Caring for the Camera and Battery: Cautions.	898

Cautions: Using the Camera.	898
Cautions: Using Batteries.	902
Cautions: Using the Charger.	904
Cautions: Using the Charging AC Adapter.	904
Specifications.	905
Nikon Z 9 Digital Camera.	905
Approved Memory Cards.	920
Memory Card Capacity.	921
Battery Endurance.	923
Trademarks and Licenses.	925
Cautions: Location Data (GPS/GLONASS).	928
Notices.	929
Bluetooth and Wi-Fi (Wireless LAN).	932
Changes with “C” Firmware Version 4.00.	937
Features Available with “C” Firmware Version 4.00.	937
“Firmware Version”.	937
Changes Made with “C” Firmware Version 4.00.	938
Still Photography.	938
Video Recording.	938
Playback.	938
Controls.	938
Displays.	939
Networks.	939
New Bracketing Increments.	940
More Time for Pre-Release Capture.	941
New Large Size Option for JPEG + JPEG Recording.	942
New Menu Item: “Auto Capture”.	943
The Auto Capture Settings Display.	944
Taking Pictures Using Auto Capture.	946
Low ISO Sensitivity Settings for N-Log Video.	961
New Options for Hi-Res Zoom Speed.	962
New: Slow-Motion Videos.	963

Changes to z -Menu “Select for Upload” Options.	965
“Priority Upload” Options Added to z Menu.	966
Support for Power Zoom.	967
New Custom Setting: f12 “Assign Power Zoom Buttons”.	967
New Custom Setting: g9 “Assign Power Zoom Buttons”.	967
New Setup Menu Item: “Save Zoom Position (PZ Lenses)”.	968
The Focal Length Display.	968
New Custom Setting: d6 “Exposure Delay Mode”.	969
New Options for Custom Settings f2 “Custom Controls (Shooting)” and g2 “Custom Controls”.	970
New Reset Option.	970
Newly Customizable Controls.	970
New Roles Available via Custom Setting f2 “Custom Controls (Shooting)”.	971
New Roles Available via Custom Setting g2 “Custom Controls”.	971
New Options for Custom Setting f3: “Custom Controls (Playback)”.	972
New Reset Option.	972
Newly Customizable Controls.	972
New Roles.	973
Updates to “Non-CPU Lens Data”.	974
Increased Character Limit for IPTC “Category” Entries.	975
New Shutter Sound and Volume Options.	976
Support for “Viewfinder Display Size” Selection in Video Mode.	977
Updated Distance Display for Manual Focus.	978
Changes and Additions to “Connect to FTP Server”.	979
Increased Profile Storage.	979
Auto Reconnect on Error.	979
Changes to Synchronized Release.	980
Configuring and Using Synchronized Release.	980
New “Overwrite Copyright Info” Option for Master Cameras.	997
Menu Items and Defaults for “C” Firmware Version 4.00.	998
Photo Shooting Menu.	998
Video Recording Menu.	1001
Custom Settings Menu.	1003

Playback Menu.....	1010
Setup Menu.....	1011
Network Menu.....	1014
My Menu/Recent Settings.....	1016
Post-Upgrade Specifications for "C" Firmware Version 4.00.....	1017
Changes with "C" Firmware Version 4.10.....	1030
Changes Made with "C" Firmware Version 4.10.....	1030
New AF Subject Detection Options: Birds and Airplanes.....	1031
Index.....	1033
Index.....	1033
Symbols, Numerics.....	1033
A.....	1033
B.....	1034
C.....	1034
D.....	1035
E.....	1035
F.....	1035
G.....	1036
H.....	1036
I.....	1036
J.....	1037
K.....	1037
L.....	1037
M.....	1037
N.....	1037
O.....	1038
P.....	1038
Q.....	1038
R.....	1038
S.....	1039
T.....	1039
U.....	1039

V..... 1040
W..... 1040
Z..... 1040

Introduction

When Your First Photo Can't Wait

Getting Ready

1 Insert the battery (📖 83).

For information on charging the battery, see “Charging the Battery” (📖 79).

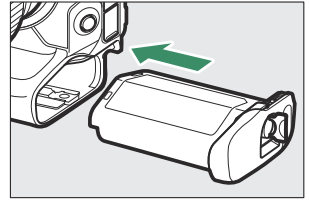

2 Insert a memory card (📖 86).

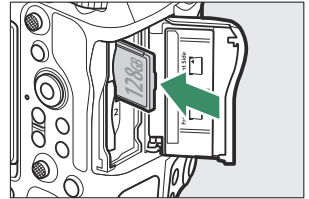

3 Attach a lens (📖 88).

- Align the mounting mark on the lens with the matching mark on the camera body (①) and rotate the lens in the direction shown (②).
- A strap can be attached to the camera. For more information, see “Attaching the Strap” (📖 78).

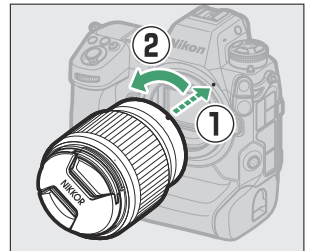

- 4 Turn the camera on and then choose a language and set the clock (📖 91).

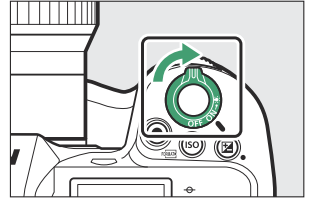

Take and View Pictures

- 1 To focus, press the shutter-release button halfway (i.e., lightly press the shutter-release button, stopping when it is pressed halfway) ([book 93](#)).

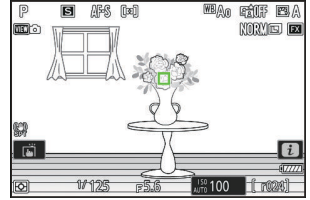

- 2 Without lifting your finger from the shutter-release button, press the button the rest of the way down to take the picture.

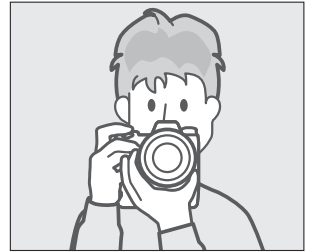

- 3 View the picture ([book 100](#)).

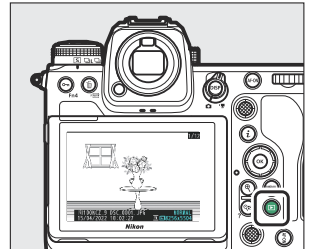

Package Contents

Be sure all items listed here were included with your camera.

- Camera

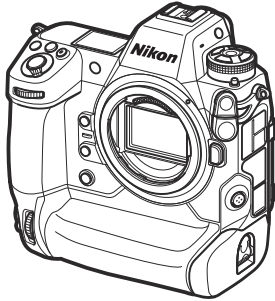

- DK-33 rubber eyecup (comes attached to camera, [book 880](#))
- BF-N1 body cap



- EN-EL18d rechargeable Li-ion battery with terminal cover
- MH-33 battery charger
- EH-7P charging AC adapter (supplied with a plug adapter attached in countries or regions where required; shape depends on country of sale—[book 81](#))
- HDMI/USB cable clip ([book 884](#))
- Strap ([book 78](#))
- Warranty
- *User's Manual*
- UC-E24 USB cable ([book 316](#))
- BS-1 accessory shoe cover (comes attached to camera; [book 883](#))

- Memory cards are sold separately.
- MH-33 battery chargers and EH-7P charging AC adapters are sold separately in some countries or regions.

The Nikon Download Center



Visit the Nikon Download Center to download firmware updates, NX Studio and other Nikon software, and documentation for Nikon products including cameras, NIKKOR lenses, and flash units.

<https://downloadcenter.nikonimglib.com/>

About This Document

Symbols

This document employs the following symbols. Use them to help locate the information you need.

	This icon marks notes, information that should be read before using this product.
Tip	This icon marks tips, additional information you may find helpful when using this product.
	This icon marks references to other sections in this document.

Conventions

- This camera uses CFexpress (Type B) and XQD memory cards. Memory cards of all types are referred to throughout this document as “memory cards”. Where it is necessary to distinguish between the different types, the terms “CFexpress memory card” and “XQD memory card” may be used.
- Throughout this document, battery chargers are referred to as “battery chargers” or “chargers”.
- Throughout this document, the display in camera monitor and viewfinder during shooting is referred to as the “shooting display”. In most cases, the illustrations show the monitor.
- Throughout this document, smartphones and tablets are referred to as “smart devices”.
- Throughout this document, the term “default settings” is used to refer to the settings in effect at shipment. The explanations in this document assume that default settings are used.

For Your Safety

To prevent damage to property or injury to yourself or to others, read "For Your Safety" in its entirety before using this product.

After reading these safety instructions, keep them readily accessible for future reference.



DANGER: Failure to observe the precautions marked with this icon carries a high risk of death or severe injury.



WARNING: Failure to observe the precautions marked with this icon could result in death or severe injury.



CAUTION: Failure to observe the precautions marked with this icon could result in injury or property damage.



WARNING

Do not use while walking or operating a vehicle.

Failure to observe this precaution could result in accidents or other injury.

Do not disassemble or modify this product. Do not touch internal parts that become exposed as the result of a fall or other accident.

Failure to observe these precautions could result in electric shock or other injury.

Should you notice any abnormalities such as the product producing smoke, heat, or unusual odors, immediately disconnect the battery or power source.

Continued operation could result in fire, burns or other injury.

Keep dry. Do not handle with wet hands. Do not handle the plug with wet hands.

Failure to observe these precautions could result in fire or electric shock.

Do not let your skin remain in prolonged contact with this product while it is on or plugged in.

Failure to observe this precaution could result in low-temperature burns.



WARNING

Do not use this product in the presence of flammable dust or gas such as propane, gasoline or aerosols.

Failure to observe this precaution could result in explosion or fire.

Do not directly view the sun or other bright light source through the lens.

Failure to observe this precaution could result in visual impairment.

Do not aim the flash or AF-assist illuminator at the operator of a motor vehicle.

Failure to observe this precaution could result in accidents.

Keep this product out of reach of children.

Failure to observe this precaution could result in injury or product malfunction. In addition, note that small parts constitute a choking hazard. Should a child swallow any part of this product, seek immediate medical attention.

Do not entangle, wrap or twist the straps around your neck.

Failure to observe this precaution could result in accidents.

Do not use batteries, chargers, or AC adapters not specifically designated for use with this product. When using batteries, chargers, and AC adapters designated for use with this product, do not:

- **Damage, modify, forcibly tug or bend the cords or cables, place them under heavy objects, or expose them to heat or flame.**
- **Use travel converters or adapters designed to convert from one voltage to another or with DC-to-AC inverters.**

Failure to observe these precautions could result in fire or electric shock.

Do not handle the plug when charging the product or using the AC adapter during thunderstorms.

Failure to observe this precaution could result in electric shock.

Dust on or near the metal parts of the plug should be removed with a dry cloth.

Continued use could result in fire.

Do not handle with bare hands in locations exposed to extremely high or low temperatures.

Failure to observe this precaution could result in burns or frostbite.



CAUTION

Do not leave the lens pointed at the sun or other strong light sources.

Light focused by the lens could cause fire or damage to product's internal parts. When shooting backlit subjects, keep the sun well out of the frame. Sunlight focused into the camera when the sun is close to the frame could cause fire.

Turn the product off when its use is prohibited. Disable the location data feature. End location tracking. Disable wireless features when the use of wireless equipment is prohibited.

The radio-frequency emissions produced by this product could interfere with equipment onboard aircraft or in hospitals or other medical facilities.

Remove the battery and disconnect the AC adapter if this product will not be used for an extended period.

Failure to observe this precaution could result in fire or product malfunction.

Do not fire the flash in contact with or in close proximity to the skin or objects.

Failure to observe this precaution could result in burns or fire.

Do not leave the product where it will be exposed to extremely high temperatures, for an extended period such as in an enclosed automobile or in direct sunlight.

Failure to observe this precaution could result in fire or product malfunction.

Do not look directly at the AF-assist illuminator.

Failure to observe this precaution could have adverse effects on vision.

Do not transport cameras or lenses with tripods or similar accessories attached.

Failure to observe this precaution could result in injury or product malfunction.

Do not touch the camera or memory cards when a high-temperature warning is displayed in the monitor or viewfinder.

The camera and memory cards will be hot, potentially causing burns or causing the cards or battery to be dropped and damaged when removed.



Keep the product at least 5 cm (2.0 in.) from pacemakers and other medical devices.

Medical devices in close proximity could be affected by the magnet or magnets in the product.



DANGER (Batteries)

Do not mishandle batteries.

Failure to observe the following precautions could result in the batteries leaking, overheating, rupturing, or catching fire:

- Use only rechargeable batteries approved for use in this product.
- Do not expose batteries to flame or excessive heat.
- Do not disassemble.
- Do not short-circuit the terminals by touching them to necklaces, hairpins, or other metal objects.
- Do not expose batteries or the products in which they are inserted to powerful physical shocks.
- Do not step on batteries, pierce them with nails, or strike them with hammers.

Charge only as indicated.

Failure to observe this precaution could result in the batteries leaking, overheating, rupturing, or catching fire.

If battery liquid comes into contact with the eyes, rinse with plenty of clean water and seek immediate medical attention.

Delaying action could result in eye injuries.

Follow the instructions of airline personnel.

Batteries left unattended at high altitudes in an unpressurized environment may leak, overheat, rupture, or catch fire.



WARNING (Batteries)

Keep batteries out of reach of children.

Should a child swallow a battery, seek immediate medical attention.

Keep batteries out of reach of household pets and other animals.

The batteries could leak, overheat, rupture, or catch fire if bitten, chewed, or otherwise damaged by animals.

Do not immerse batteries in water or expose to rain.

Failure to observe this precaution could result in fire or product malfunction. Immediately dry the product with a towel or similar object should it become wet.



WARNING (Batteries)

Discontinue use immediately should you notice any changes in the batteries, such as discoloration or deformation. Cease charging EN-EL18d rechargeable batteries if they do not charge in the specified period of time.

Failure to observe these precautions could result in the batteries leaking, overheating, rupturing, or catching fire.

When batteries are no longer needed, insulate the terminals with tape.

Overheating, rupture, or fire may result should metal objects come into contact with the terminals.

If battery liquid comes into contact with a person's skin or clothing, immediately rinse the affected area with plenty of clean water.

Failure to observe this precaution could result in skin irritation.

Notices

- No part of the documentation included with this product may be reproduced, transmitted, transcribed, stored in a retrieval system, or translated into any language in any form, by any means, without Nikon's prior written permission.
- Nikon reserves the right to change the appearance and specifications of the hardware and software described in this documentation at any time and without prior notice.
- Nikon will not be held liable for any damages resulting from the use of this product.
- While every effort has been made to ensure that the information in this documentation is accurate and complete, we would appreciate it were you to bring any errors or omissions to the attention of the Nikon representative in your area (address provided separately).

• Notice Concerning Prohibition of Copying or Reproduction

Note that simply being in possession of material that has been digitally copied or reproduced by means of a scanner, digital camera, or other device may be punishable by law.

• Items prohibited by law from being copied or reproduced

Do not copy or reproduce paper money, coins, securities, government bonds, or local government bonds, even if such copies or reproductions are stamped "Sample".

The copying or reproduction of paper money, coins, or securities which are circulated in a foreign country is prohibited.

Unless the prior permission of the government has been obtained, the copying or reproduction of unused postage stamps or post cards issued by the government is prohibited.

The copying or reproduction of stamps issued by the government and of certified documents stipulated by law is prohibited.

• Cautions on certain copies and reproductions

The government has issued cautions on copies or reproductions of securities issued by private companies (shares, bills, checks, gift certificates, etc.), commuter passes, or coupon tickets, except when a minimum of necessary copies are to be provided for business use by a company. Also, do not copy or reproduce passports issued by the government, licenses issued by public agencies and private groups, ID cards, and tickets, such as passes and meal coupons.

• Comply with copyright notices

Under copyright law, photographs or recordings of copyrighted works made with the camera cannot be used without the permission of the copyright holder. Exceptions apply to personal use, but note that even personal use may be restricted in the case of photographs or recordings of exhibits or live performances.

• Use Only Nikon Brand Electronic Accessories

Nikon cameras include complex electronic circuitry. Only Nikon brand electronic accessories (including lenses, chargers, batteries, AC adapters, and flash accessories) certified by Nikon specifically for use with this Nikon digital camera are engineered and proven to operate within the operational and safety requirements of this electronic circuitry.

The use of non-Nikon electronic accessories could damage the camera and may void your Nikon warranty. The use of third-party rechargeable Li-ion batteries not bearing the Nikon holographic seal shown below could interfere with normal operation of the camera or result in the batteries overheating, igniting, rupturing, or leaking.

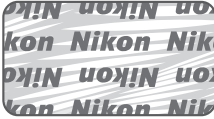

For more information about Nikon brand accessories, contact a local authorized Nikon dealer.

• Memory Cards

- Memory cards may be hot after use. Observe due caution when removing memory cards from the camera.
- Do not perform the following operations during formatting or while data are being recorded, deleted, or copied to a computer or other device. Failure to observe these precautions could result in loss of data or in damage to the camera or card.
 - Do not remove or insert memory cards.
 - Do not turn the camera off.
 - Do not remove the battery.
 - Do not disconnect AC adapters.
- Do not touch the card terminals with your fingers or metal objects.
- Do not use excessive force when handling memory cards. Failure to observe this precaution could damage the card.
- Do not bend or drop memory cards or subject them to strong physical shocks.
- Do not expose memory cards to water, heat, or direct sunlight.
- Do not format memory cards in a computer.

✔ Before Taking Important Pictures

Before taking pictures on important occasions (such as at weddings or before taking the camera on a trip), take a test shot to ensure that the camera is functioning normally. Nikon will not be held liable for damages or lost profits that may result from product malfunction.

✔ Life-Long Learning

As part of Nikon's "Life-Long Learning" commitment to ongoing product support and education, continually-updated information is available on-line at the following sites:

- **For users in the U.S.A.:** <https://www.nikonusa.com/>
- **For users in Europe:** <https://www.europe-nikon.com/support/>
- **For users in Asia, Oceania, the Middle East, and Africa:** <https://www.nikon-asia.com/>



Visit these sites to keep up-to-date with the latest product information, tips, answers to frequently-asked questions (FAQs), and general advice on digital imaging and photography. Additional information may be available from the Nikon representative in your area. See the following URL for contact information: <https://imaging.nikon.com/>

Getting to Know the Camera and Its Menus

Parts of the Camera

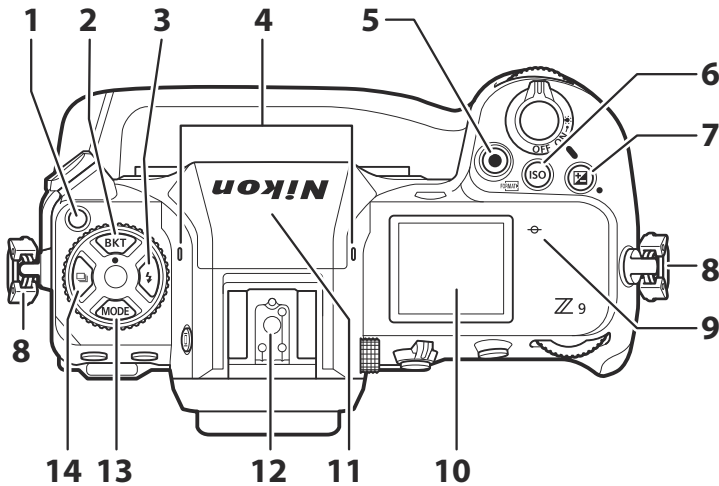
Camera Body



- 1** Release mode dial lock release ([book 139](#))
- 2** BKT button ([book 170](#))
- 3** 1/4 button ([book 409](#))
- 4** Stereo microphone (for videos; [book 97](#))
- 5** Video-record button ([book 97](#))
- 6** ISO (ISO) button ([book 147](#))
- 7**  button ([book 137](#))
- 8** Eyelet for camera strap ([book 78](#))
- 9**  (focal plane mark; [book 126](#))
- 10** Control panel ([book 46](#), [book 843](#))
- 11** GNSS antenna ([book 193](#))
- 12** Accessory shoe (for optional flash unit; [book 404](#), [book 846](#))
- 13** MODE button ([book 127](#))
- 14**  button ([book 139](#))

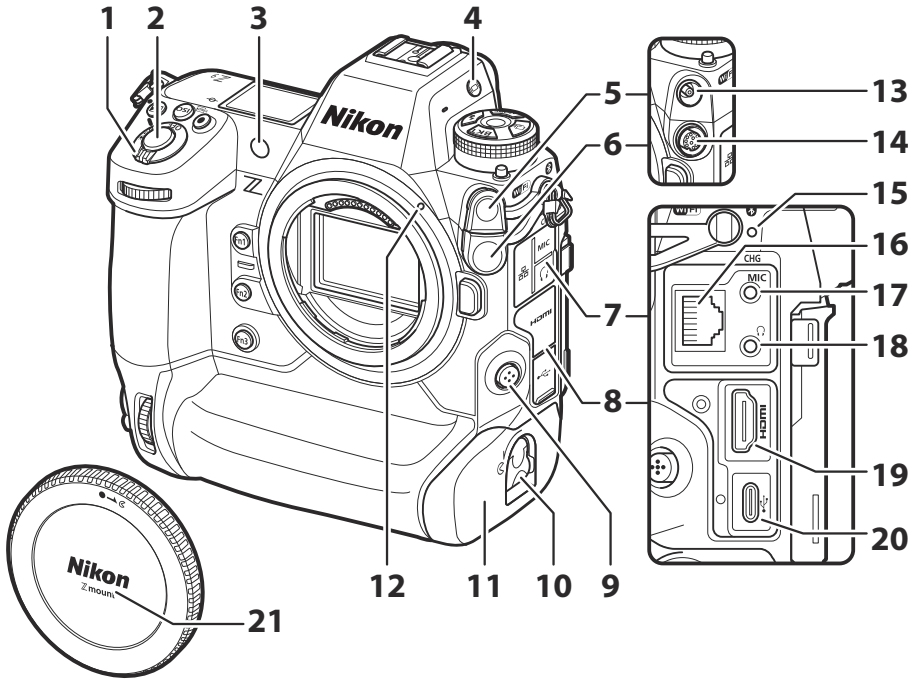

- | | |
|---|--|
| 1 Power switch (📖 91 , 📖 93) | 11 Battery chamber cover (📖 83) |
| 2 Shutter-release button (📖 93) | 12 Lens mounting mark (📖 88) |
| 3 AF-assist illuminator (📖 94 , 📖 584) | 13 Flash sync terminal (📖 406) |
| Red-eye reduction lamp (📖 409) | 14 Ten-pin remote terminal |
| Self-timer lamp (📖 145) | 15 Charge lamp (📖 81) |
| 4 \square button (📖 55 , 📖 733) | 16 Ethernet connector (📖 335 , 📖 368) |
| 5 Flash sync terminal cover | 17 Connector for external microphone (📖 881) |
| 6 Ten-pin remote terminal cover | 18 Headphone connector (📖 557) |
| 7 Cover for microphone, headphone, and Ethernet connectors | 19 HDMI connector (📖 295) |
| 8 Cover for USB and HDMI connectors | 20 USB connector (📖 316 , 📖 769) |
| 9 Focus-mode button (📖 110) | 21 Body cap (📖 88) |
| 10 Battery chamber cover latch (📖 83) | |

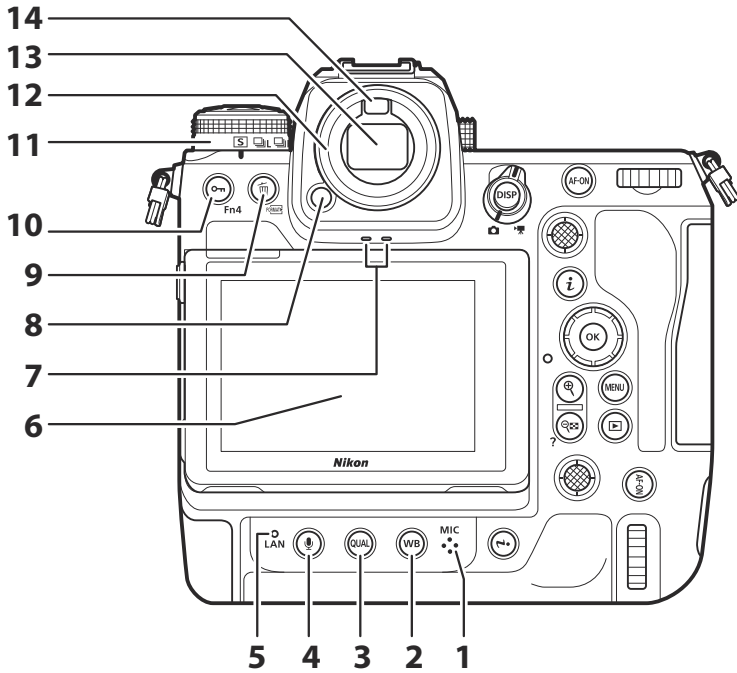

- | | |
|--|--|
| 1 Microphone (for voice memos; book 292) | 8 Eyepiece release (book 880) |
| 2 WB button (book 151) | 9 button (book 103 , book 256) |
| 3 QUAL button (book 106) | 10 (Fn4) button (book 183 , book 248) |
| 4 button (book 292) | 11 Release mode dial (book 139) |
| 5 Network indicator (book 345 , book 380) | 12 Rubber eyecup (book 880) |
| 6 Monitor (book 59 , book 120) | 13 Viewfinder (book 51) |
| 7 Speaker (book 101) | 14 Eye sensor (book 55) |

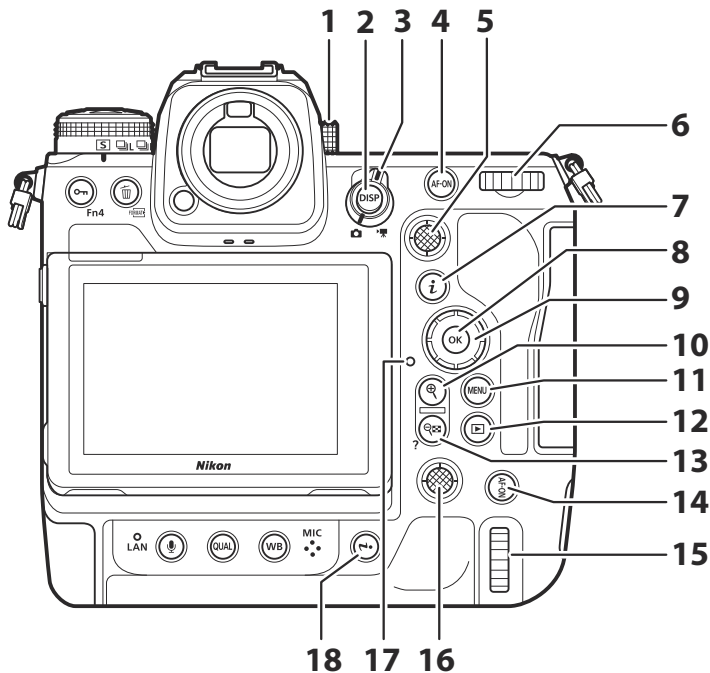

- | | |
|--|--|
| 1 Diopter adjustment control (book 58) | 10 Q button (book 124 , book 226 , book 246) |
| 2 DISP button (book 49 , book 53) | 11 MENU button (book 65) |
| 3 Photo/video selector (book 93 , book 97) | 12 Play button (book 100 , book 225) |
| 4 AF-ON button (book 123) | 13 Q (?) button (book 70 , book 226 , book 246) |
| 5 Sub-selector (book 119 , book 122 , book 135) | 14 AF-ON button for vertical shooting (book 123) |
| 6 Main command dial (book 661) | 15 Main command dial for vertical shooting (book 661) |
| 7 i button (book 72 , book 240) | 16 Multi selector for vertical shooting (book 119) |
| 8 * button (book 66) | 17 Memory card access lamp (book 95 , book 98) |
| 9 Multi selector (book 66) | 18 i button for vertical shooting (book 72 , book 240) |

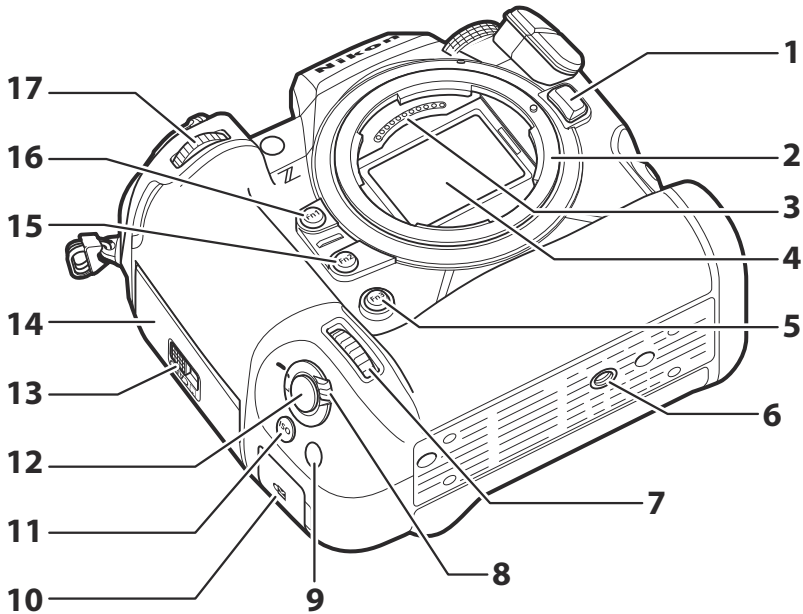

- | | |
|---|---|
| 1 Lens release button (📖 90) | 10 Security slot (for anti-theft cable; 📖 45) |
| 2 Lens mount (📖 88 , 📖 126) | 11 ISO button for vertical shooting (📖 147) |
| 3 CPU contacts | 12 Shutter-release button for vertical shooting |
| 4 Image sensor (📖 894) | 13 Memory card slot cover latch (📖 86) |
| 5 Fn3 button | 14 Memory card slot cover (📖 87) |
| 6 Tripod socket | 15 Fn2 button (📖 104) |
| 7 Sub-command dial for vertical shooting (📖 661) | 16 Fn1 button |
| 8 Shutter-release button lock for vertical shooting (📖 96) | 17 Sub-command dial (📖 661) |
| 9 Fn button for vertical shooting | |

✔ Do Not Touch the Image Sensor or Sensor Shield

Under no circumstances should you poke or exert pressure on the image sensor or sensor shield ([📖 742](#)) or subject them to powerful air currents from a blower. Failure to observe this precaution could scratch or otherwise damage the sensor or shield. For information on cleaning the image sensor, see “Image Sensor Cleaning” ([📖 894](#)).

Tip: Notes on the Monitor

The angle of the monitor can be adjusted.

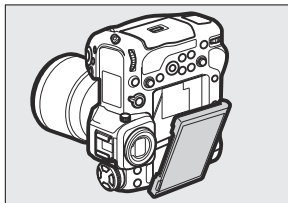
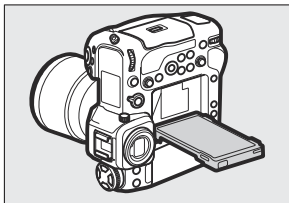
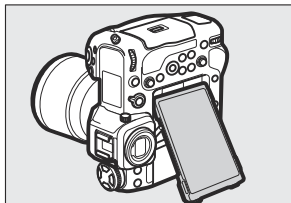
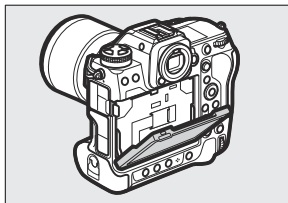
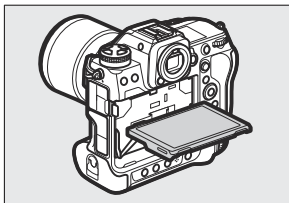
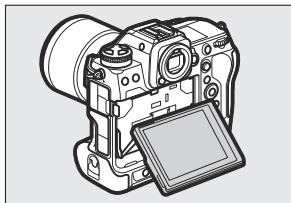
**Tip: Product Serial Number**

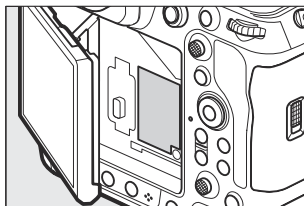

The serial number for this product can be found by opening the monitor.



Tip: The GNSS Antenna

If possible, stay in the open when using location data services. Keep the antenna pointed to the sky for best reception.

Tip: The LCD Illuminator

Rotating the power switch to  activates the backlights for the buttons and control panel (LCD illuminator). The backlights will remain lit for a few seconds after the power switch is released. The backlights turn off when the switch is rotated to  a second time or the shutter-release button is pressed halfway. Activating the button backlight makes the camera easier to use in the dark.

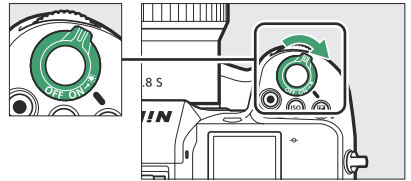

Tip: The Security Slot

The security slot serves as an attachment point for third-party anti-theft cables. It is compatible and intended for use with Kensington security cable locks. For more information, see the documentation provided with the security cable lock.

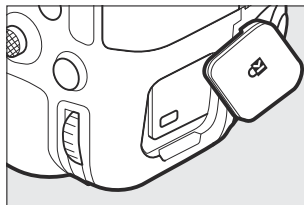

The Control Panel

The control panel lights when the camera is on. At default settings, the following indicators are displayed. For a full list of the indicators that may be displayed, see “The Control Panel” ([book 843](#)) in the section on “Camera Displays” in the “Technical Notes” chapter.

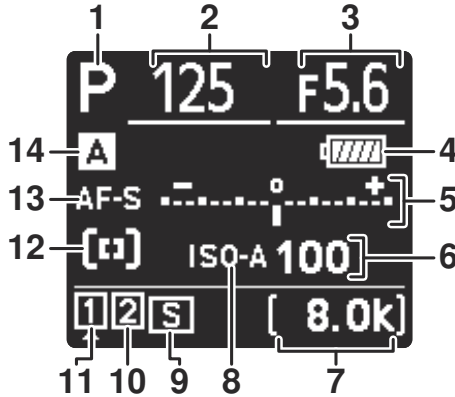

- 1** Shooting mode ([book 127](#))
- 2** Shutter speed ([book 128](#), [book 129](#))
- 3** Aperture ([book 128](#), [book 129](#))
- 4** Battery indicator ([book 85](#))
- 5** Exposure indicator
 - Exposure ([book 130](#))
 - Exposure compensation ([book 137](#))
 - Frame size and rate ([book 205](#))
- 6** ISO sensitivity ([book 147](#))
- 7** Number of exposures remaining ([book 86](#), [book 921](#))
Available recording time ([book 97](#))
- 8** ISO sensitivity indicator ([book 147](#))
Auto ISO sensitivity indicator ([book 149](#))
- 9** Release mode ([book 139](#))
- 10** Memory card icon (Slot 2; [book 447](#))
- 11** Memory card icon (Slot 1; [book 447](#))
- 12** AF-area mode indicator ([book 112](#))
- 13** Focus mode ([book 110](#))
- 14** Shooting menu bank ([book 439](#))

The Monitor

At default settings, the following indicators appear in the monitor. For a full list of the indicators that may be displayed, see the “The Monitor” ([book 833](#)) in the section on “Camera Displays” in the “Technical Notes” chapter.

Photo Mode

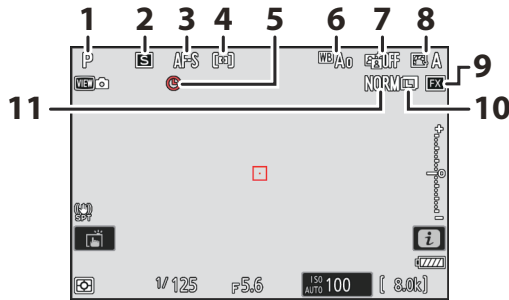
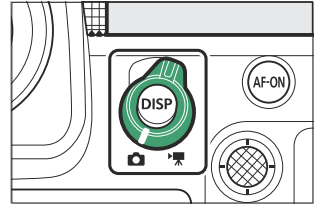

- 1 Shooting mode ([book 127](#))
- 2 Release mode ([book 139](#))
- 3 Focus mode ([book 119](#))
- 4 AF-area mode ([book 112](#))
- 5 ⊕ icon ([book 92](#))
- 6 White balance ([book 151](#))

- 7 Active D-Lighting ([book 459](#))
- 8 Picture Control ([book 183](#))
- 9 Image area ([book 104](#))
- 10 Image size ([book 108](#))
- 11 Image quality ([book 106](#))

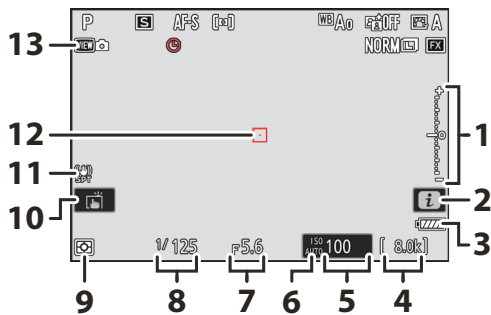

- | | |
|---|---|
| <p>1 Exposure indicator</p> <ul style="list-style-type: none"> • Exposure (130) • Exposure compensation (137) <p>2 <i>i</i> icon (72, 240)</p> <p>3 Battery indicator (85)</p> <p>4 Number of exposures remaining (86, 921)</p> <p>5 ISO sensitivity (147)</p> <p>6 ISO sensitivity indicator (147)</p> <p>Auto ISO sensitivity indicator (149)</p> | <p>7 Aperture (128, 129)</p> <p>8 Shutter speed (128, 129)</p> <p>9 Metering (470)</p> <p>10 Touch shooting (120)</p> <p>11 Vibration reduction indicator (477)</p> <p>12 Focus point (119)</p> <p>13 View mode (photo live view; 608)</p> |
|---|---|

Tip: Using the Monitor with the Camera in “Tall” Orientation

When the camera is rotated to take pictures in “tall” (portrait) orientation, the display in the monitor rotates to match (photo mode only).

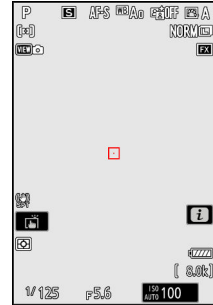
**Tip: Choosing a Display**

Press the **DISP** button to cycle the shooting display. Choose from up to five displays, each with a customizable selection of icons and indicators. The items displayed can be selected using Custom Setting d18 [**Custom monitor shooting display**] ([book 621](#)).

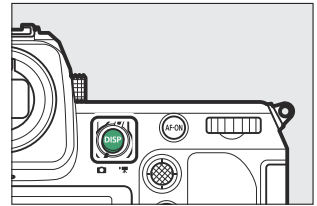

Video Mode

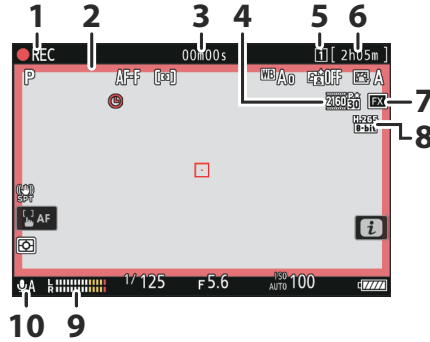
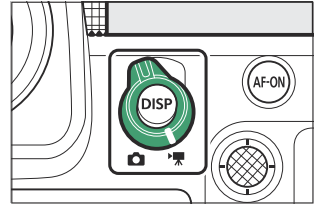

- 1 Recording indicator ([97](#))
"No video" indicator ([98](#))
- 2 Recording indicator (red border; [700](#))
- 3 Video recording time ([97](#))
- 4 Frame size and rate ([205](#))
- 5 Destination ([528](#))
- 6 Time remaining ([97](#))
- 7 Image area ([212](#))
- 8 Video file type ([202](#))
- 9 Sound level ([552](#))
- 10 Microphone sensitivity ([552](#))

The Viewfinder

At default settings, the following indicators appear in the viewfinder. For a full list of the indicators that may be displayed, see “The Viewfinder” ([book 840](#)) in the section on “Camera Displays” in the “Technical Notes” chapter.

Photo Mode

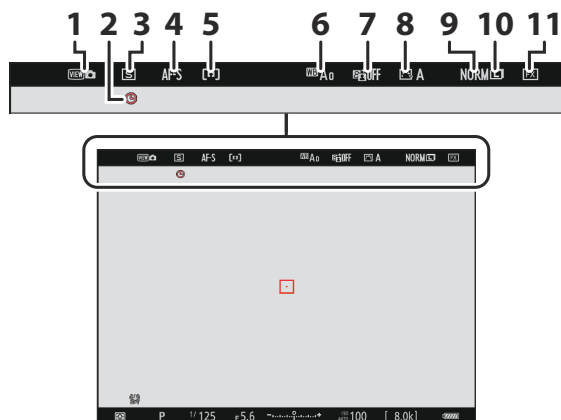
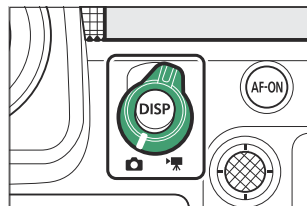

- 1 View mode (photo live view; [book 608](#))
- 2 ☺ icon ([book 92](#))
- 3 Release mode ([book 139](#))
- 4 Focus mode ([book 110](#))
- 5 AF-area mode ([book 112](#))
- 6 White balance ([book 151](#))
- 7 Active D-Lighting ([book 459](#))
- 8 Picture Control ([book 183](#))
- 9 Image quality ([book 106](#))
- 10 Image size ([book 108](#))
- 11 Image area ([book 104](#))

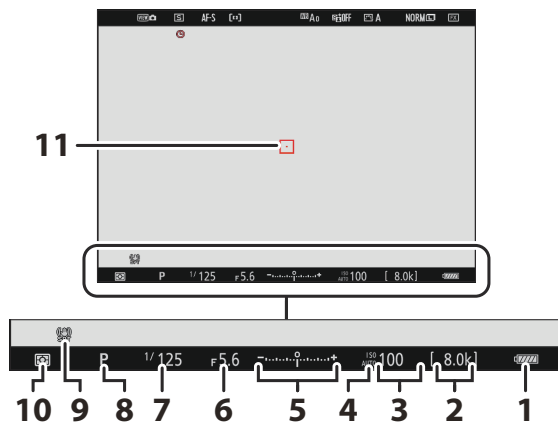

- | | |
|--|---|
| <p>1 Battery indicator (📖 85)</p> <p>2 Number of exposures remaining (📖 86, 📖 921)</p> <p>3 ISO sensitivity (📖 147)</p> <p>4 ISO sensitivity indicator (📖 147)
Auto ISO sensitivity indicator (📖 149)</p> <p>5 Exposure indicator</p> <ul style="list-style-type: none"> • Exposure (📖 130) • Exposure compensation (📖 137) | <p>6 Aperture (📖 128, 📖 129)</p> <p>7 Shutter speed (📖 128, 📖 129)</p> <p>8 Shooting mode (📖 127)</p> <p>9 Vibration reduction (📖 477)</p> <p>10 Metering (📖 470)</p> <p>11 Focus point (📖 119)</p> |
|--|---|

Tip: Using the Viewfinder with the Camera in “Tall” Orientation

When the camera is rotated to take pictures in “tall” (portrait) orientation, the display in the viewfinder rotates to match (photo mode only).

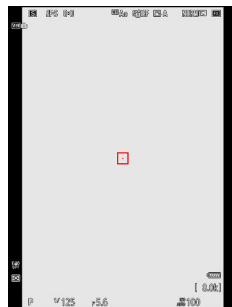
**Tip: Choosing a Display**

Press the **DISP** button to cycle the shooting display. Choose from up to four displays, each with a customizable selection of icons and indicators. The items displayed can be selected using Custom Setting d19 [**Custom viewfinder shooting display**] ([623](#)).

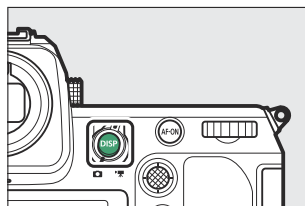

Video Mode

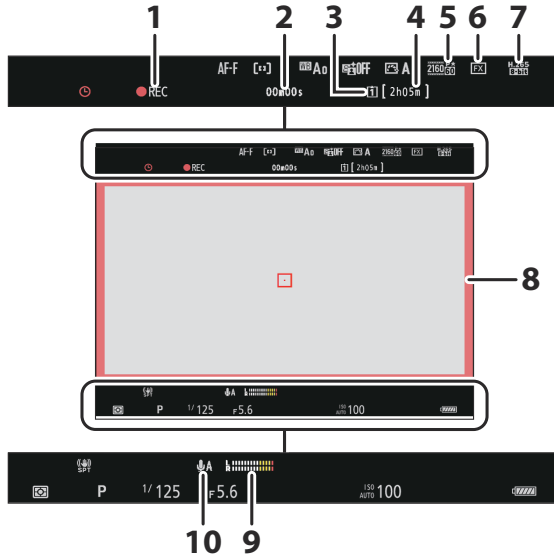
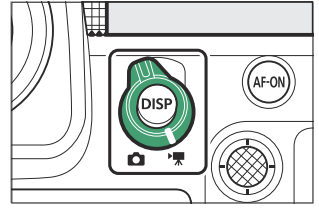

- 1 Recording indicator ([book 97](#))
"No video" indicator ([book 98](#))
- 2 Video recording time ([book 97](#))
- 3 Destination ([book 528](#))
- 4 Time remaining ([book 97](#))
- 5 Frame size/frame rate ([book 205](#))
- 6 Image area ([book 212](#))
- 7 Video file type ([book 202](#))
- 8 Recording indicator (red border; [book 700](#))
- 9 Sound level ([book 552](#))
- 10 Microphone sensitivity ([book 552](#))

The Monitor Mode Button and the Eye Sensor

Placing your eye to the viewfinder activates the eye sensor, switching the display from the monitor to the viewfinder. Note that the eye sensor will also respond to other objects, such as your fingers.

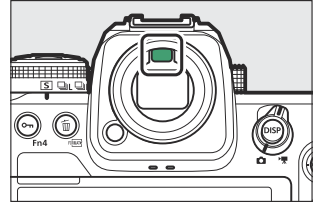

- The viewfinder can be used for menus and playback if desired.
- Press the  (monitor mode) button to cycle between viewfinder and monitor displays.



- Press the  button to cycle through the displays as follows.

[Automatic display switch]: The camera automatically switches between the viewfinder and monitor displays based on information from the eye sensor.

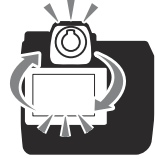

[Viewfinder only]: The monitor remains blank. The viewfinder is used for shooting, menus, and playback.

- In photo mode, the viewfinder turns on for a few seconds after the camera is turned on, the shutter-release button is pressed halfway, or the **AF-ON** button is pressed, regardless of whether placing your eye to the viewfinder.



[Monitor only]: The monitor is used for shooting, menus, and playback. The viewfinder display will remain blank even if you put your eye to the viewfinder.



[Prioritize viewfinder (1)]: Placing your eye to the viewfinder turns the viewfinder on; the monitor remains off after you take your eye away. In video mode, the displays function as per **[Automatic display switch]**.



[Prioritize viewfinder (2)]: In photo mode, in addition to when you look through it, the viewfinder turns on for a few seconds after the camera is turned on, the shutter-release button is pressed halfway, or the **AF-ON** button is pressed regardless of whether placing your eye to the viewfinder. In video mode, the displays function as per **[Automatic display switch]**.

- The shooting display appears in the viewfinder if you put your eye to it while the monitor is used for menus or playback.



✓ The Diopter Adjustment Control

- The viewfinder can be focused by lifting and rotating the diopter adjustment control.
- Be careful not to put your fingers or fingernails in your eye.
- After adjusting diopter, push the diopter adjustment control back into its original position.

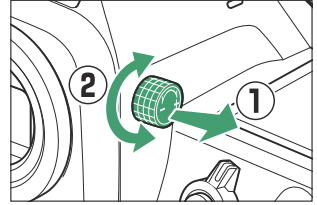

✓ Tilting the Monitor

Putting your eye to the camera when the monitor is tilted will not trigger the viewfinder if both the following conditions are met:

- **[Automatic display switch]**, **[Prioritize viewfinder (1)]**, or **[Prioritize viewfinder (2)]** is selected for monitor mode, and
 - a menu, picture, or other display currently appears in the monitor.
-

Tip: Extended Use

When using the viewfinder for extended periods, you can select **[Adjust for ease of viewing]** for Custom Setting d9 **[View mode (photo Lv)]** to ensure that viewfinder brightness and hue are adjusted for ease of viewing.

Tip: Limit Monitor Mode Selection

You can limit the choice of monitor modes available using the **[Limit monitor mode selection]** item in the setup menu.

Touch Controls

The touch-sensitive monitor offers a variety of controls that can be operated by touching the display with your fingers. During viewfinder photography, touch controls are disabled and cannot be used for focus or the like.

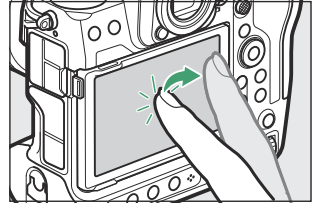

Focusing and Releasing the Shutter

- Touch the monitor to focus on the selected point (touch AF).
- In photo mode, the shutter will be released when you lift your finger from the display (touch shutter).

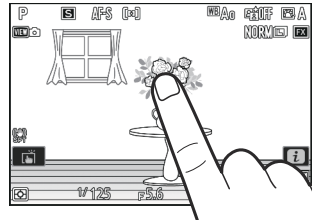

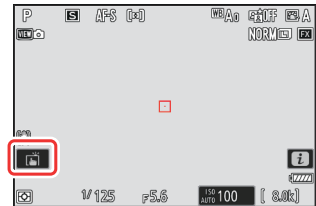

- Touch shutter/AF settings can be adjusted by tapping the  icon ([120](#)).



Adjusting Settings

- Tap highlighted settings in the display.
- You can then choose the desired option by tapping icons or sliders.

- Tap  or press  to select the chosen option and return to the previous display.

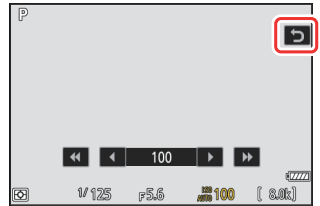
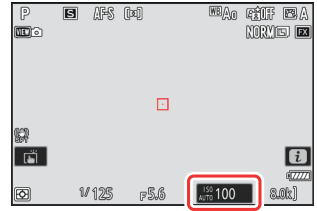

Playback

- Flick left or right to view other pictures during full-frame playback.

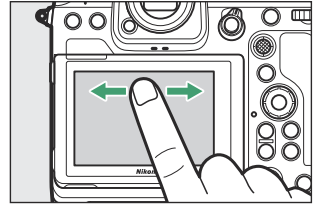

- In full-frame playback, touching the bottom of the display brings up a frame-advance bar. Slide your finger left or right over the bar to scroll rapidly to other pictures.

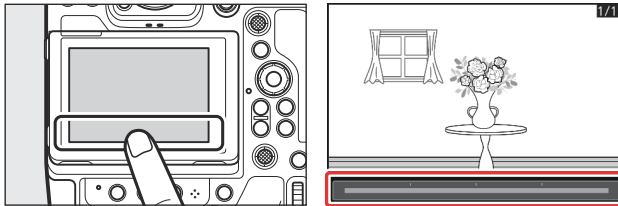

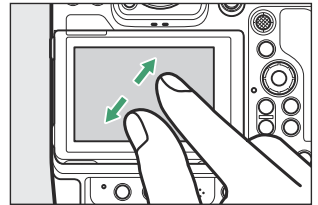

- To zoom in on a picture displayed during full-frame playback, use a stretch gesture or give the display two quick taps. You can adjust the zoom ratio using stretch gestures to zoom in and pinch gestures to zoom out.

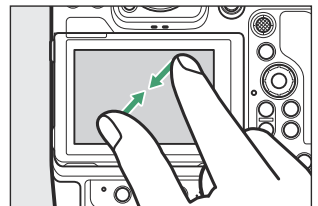

- Use slide gestures to view other parts of the picture during zoom.
- Giving the display two quick taps while zoom is in effect cancels zoom.
- To “zoom out” to a thumbnail view, use a pinch gesture during full-frame playback. Use pinch and stretch to choose the number of pictures displayed from 4, 9, and 72 frames.



Viewing Videos

- Videos are indicated by a  icon; to start playback, tap the  icon.
- Tap  to exit to full-frame playback.

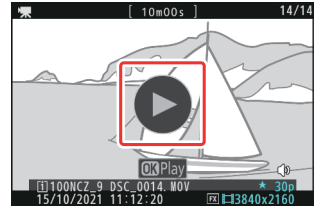

The *i* Menu

- Tap the  icon to display the *i* menu during shooting ([book 72](#)).

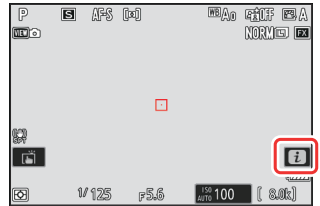

- Tap items to view and change options.
- You can choose the items displayed in the *i* menu ([book 77](#)).

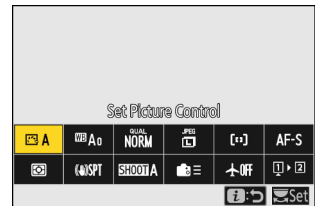



Text Entry

- When a keyboard is displayed, you can enter text by tapping the keys.



- 1 Text display area
- 2 Keyboard area
- 3 Keyboard selection

- To position the cursor, tap  or  or tap directly in the text display area.
- To cycle through the upper- and lower-case and symbol keyboards, tap the keyboard selection button.

Navigating the Menus

- Slide up or down to scroll.

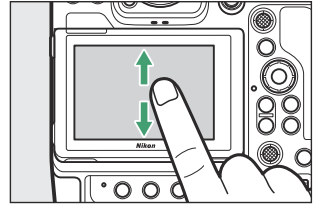

- Tap a menu icon to choose a menu.

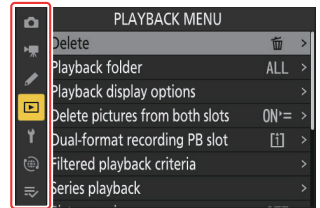

- Tap menu items to display options. You can then choose the desired option by tapping icons or sliders.

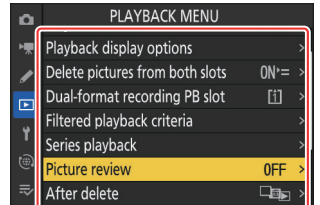

- To exit without changing settings, tap ↩.

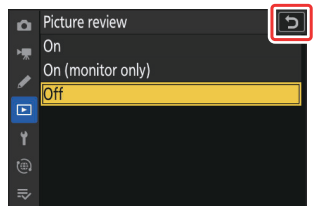

✓ **Cautions: The Touch Screen**

- The touch screen responds to static electricity. It may not respond when touched with fingernails or gloved hands. For improved response when using the touch screen with gloves, select **[ON]** for **[Touch controls]** > **[Glove mode]** in the setup menu.
 - Do not touch the screen with sharp objects.
 - Do not use excessive force.
 - The screen may not respond when covered with third-party protective films.
 - The screen may not respond when touched simultaneously in multiple locations.
-

Tip: Enabling or Disabling Touch Controls

Touch controls can be enabled or disabled using the **[Touch controls]** item in the setup menu.

The Menus

The MENU Button

Press the **MENU** button to view the menus.

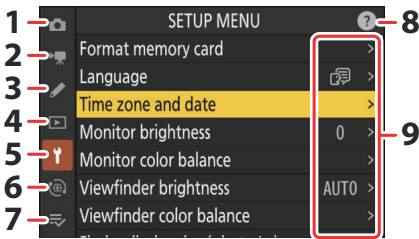
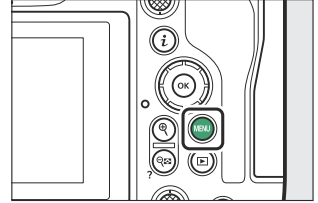

- 1 [PHOTO SHOOTING MENU] ([436](#))
- 2 [VIDEO RECORDING MENU] ([522](#))
- 3 [CUSTOM SETTINGS MENU] ([562](#))
- 4 [PLAYBACK MENU] ([701](#))
- 5 [SETUP MENU] ([721](#))
- 6 [NETWORK MENU] ([779](#))
- 7 [MY MENU]/ [RECENT SETTINGS] * ([806](#))
- 8 (help) icon ([70](#))
- 9 Current settings

* You can choose the menu displayed. The default is [MY MENU].

Using the Menus

You can navigate the menus using the multi selector and \odot button.

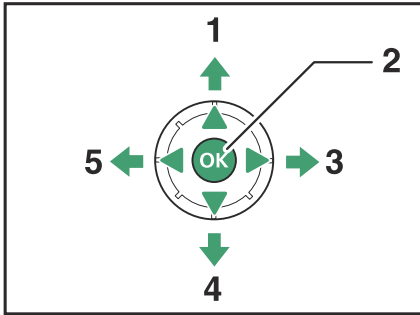

- 1 Move cursor up
- 2 Select the highlighted item
- 3 Display sub-menu, select highlighted item, or move cursor right
- 4 Move cursor down
- 5 Cancel and return to previous menu, or move cursor left

1 Highlight the icon for the current menu.

Press \odot to place the cursor in the menu-selection area.

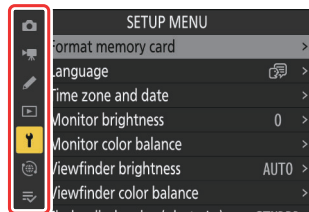
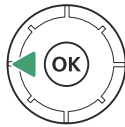

2 Select a menu.

Press \uparrow or \downarrow to select the desired menu.

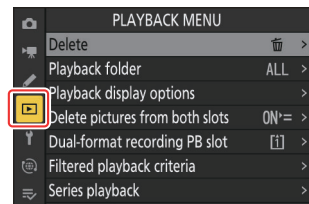
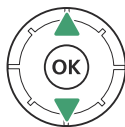

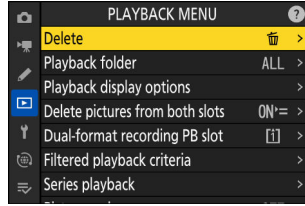
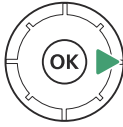

3 Position the cursor in the selected menu.

Press  to position the cursor in the selected menu.



4 Highlight a menu item.

Press  or  to highlight a menu item.

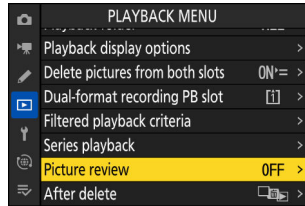

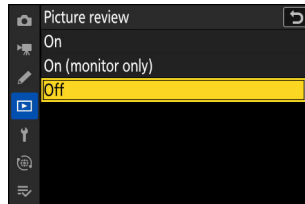
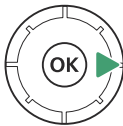

5 Display options.

Press  to display options for the selected menu item.



6 Highlight an option.

Press  or  to highlight an option.

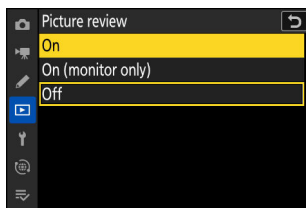

7 Select the highlighted option.

- Press  to save changes and exit.
- To exit without making a selection, press the MENU button.
- To exit the menus and return to shooting mode, press the shutter-release button halfway.

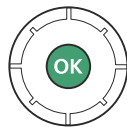

✔ Grayed-Out Items

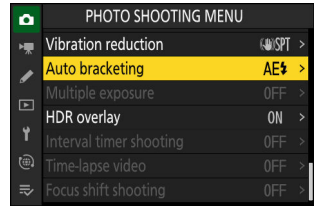

- Some items and menu options may be unavailable depending on camera status. Unavailable items are displayed in gray.

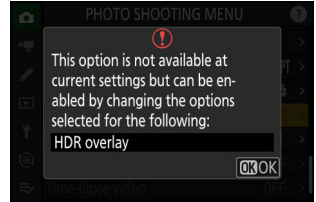

- In some cases, pressing Ⓜ when a grayed-out item is highlighted will display a message explaining why the item is unavailable.





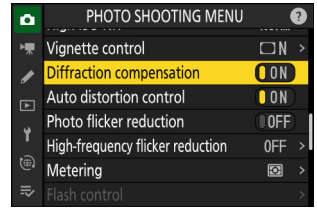

Tip: ON/ OFF Only Items

If the only options available for the current item are [ON] and [OFF], you can switch from [ON] to [OFF] or *vice versa* simply by pressing , pressing the multi selector right () or tapping the item in the display.



Tip: The (Help) Icon

- Where available, a description of the currently-selected item can be viewed by pressing the  (?) button.
- Press  or  to scroll.
- Press  (?) again to return to the menus.

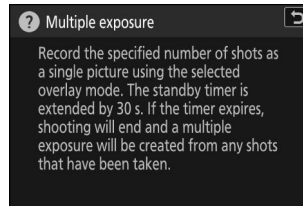
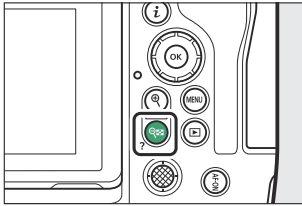

Tip: Touch Controls

You can also navigate the menus using touch controls ([59](#)).

Tip: Text Entry

A keyboard is displayed when text entry is required, for example if you are called on to enter a file name or the like. Enter text as described below.



- 1 Text display area
- 2 Keyboard area
- 3 Keyboard selection

- Enter characters at the current cursor position by highlighting them with the multi selector arrow keys and then pressing .
 - The cursor can be moved left or right in the text display area by rotating either of the command dials.
 - To cycle through the upper- and lower-case and symbol keyboards, highlight the keyboard selection icon and press . The keyboard selection icon may not be available in some cases.
 - If a character is entered when the text display area is full, the rightmost character will be deleted.
 - To delete the character under the cursor, press the ().
 - To complete entry, press .
 - To exit without completing text entry, press **MENU**.
-

The *i* Button (the *i* Menu)

For quick access to frequently-used settings, press the *i* button or tap the *i* icon to view the *i* menu.

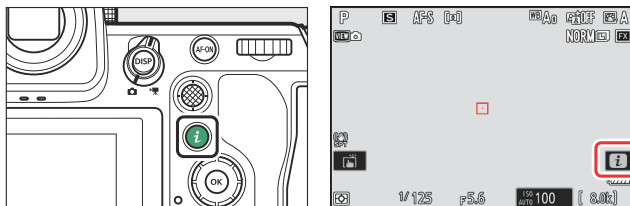

- Different menus are displayed in photo and video modes.

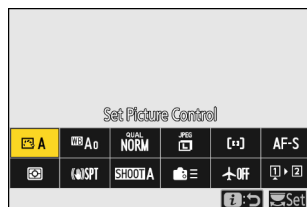

- Options can be viewed by tapping items in the display or by highlighting items and pressing **OK**; selections can then be made using the multi selector.
- Items for which the camera displays a command dial guide can be adjusted by highlighting them in the *i* menu and rotating a command dial. In some cases, adjustments can be made using both the main and sub-command dials.

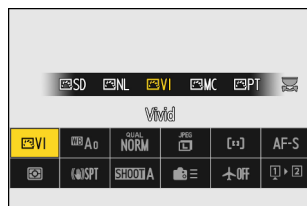

✓ Grayed-Out Items

Some items and menu options may be unavailable depending on camera status. Unavailable items are displayed in gray.

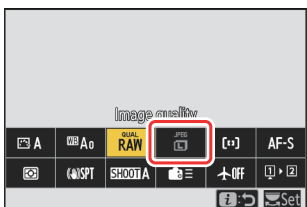

Tip: Using the *i* Menu with the Camera in “Tall” Orientation

When the camera is rotated to take pictures in “tall” (portrait) orientation, the *i* menu for photo mode rotates to match.

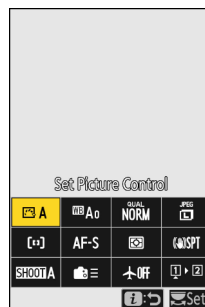

The Still Photography *i* Menu

Pressing the *i* button during still photography displays the items listed below. Highlight the desired item using the multi selector and press \odot to view options.

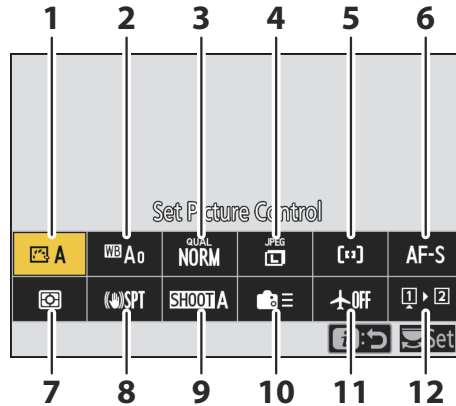

- | | |
|---|--|
| 1 Set Picture Control (183) | 7 Metering (470) |
| 2 White balance (151) | 8 Vibration reduction (477) |
| 3 Image quality (106) | 9 Shooting menu bank (439) |
| 4 Image size (108) | 10 Custom controls (shooting) (637) |
| 5 AF-area mode/subj. detection (112) | 11 Airplane mode (781) |
| 6 Focus mode (110) | 12 View memory card info (636) |

The Video *i* Menu

Pressing the *i* button during video recording displays the items listed below. Highlight the desired item using the multi selector and press \odot to view options.

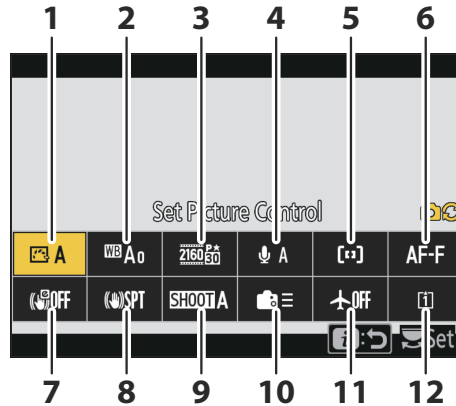

- | | |
|---|--|
| 1 Set Picture Control (📖 183) | 6 Focus mode (📖 110) |
| 2 White balance (📖 151) | 7 Electronic VR (📖 551) |
| 3 Frame size/frame rate (📖 205) | 8 Vibration reduction (📖 550) |
| 4 Microphone sensitivity (📖 552) | 9 Shooting menu bank (📖 439) |
| 5 AF-area mode/subj. detection (📖 112) | 10 Custom controls (📖 674) |
| | 11 Airplane mode (📖 781) |
| | 12 Destination (📖 528) |

The Playback *i* Menu

Pressing the *i* button during playback displays a context-sensitive *i* menu of playback options.

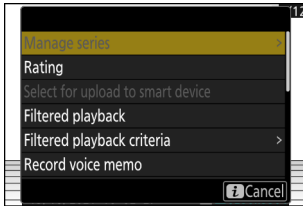

Photos

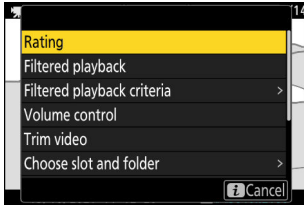

Videos

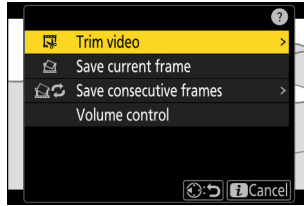

Videos (playback paused)

Customizing the *i* Menu

The items displayed in the *i* menu during shooting can be chosen using Custom Setting f1 or g1 [Customize *i* menu].

1 Highlight Custom Setting f1 or g1 [Customize *i* menu] and press .

See “The MENU Button” ([link 65](#)) for information on using the menus.

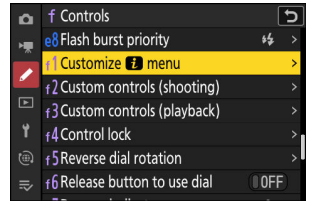

2 Highlight the position you want to change and press .

A list of the items available for the selected position will be displayed.

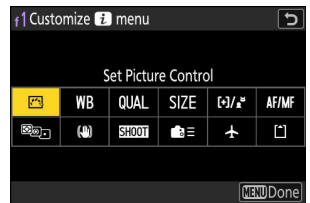

3 Highlight the desired item and press .

- The item will be assigned to the selected position and the options shown in Step 2 will be displayed.
- Repeat Steps 2 and 3 as desired.

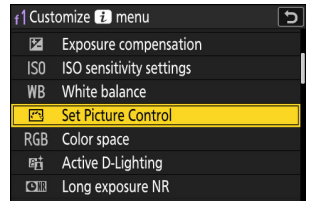

4 Press the MENU button.

Changes will be saved and the Custom Settings menu will be displayed.

First Steps

Attaching the Strap

To attach a strap (whether the supplied strap or one that has been purchased separately):

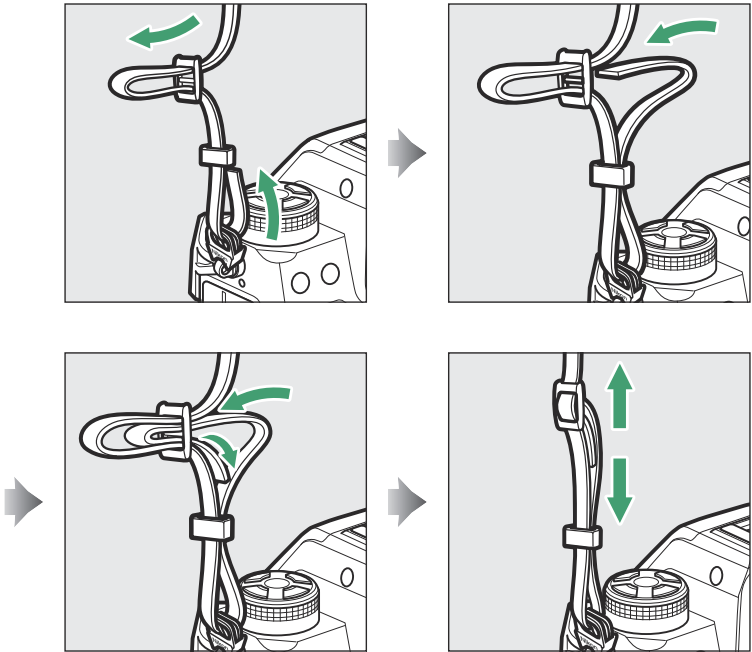

Charging the Battery

Charge the supplied EN-EL18d battery before use.

✔ Caution: The Battery and Charger

Read and follow the warnings and cautions in "For Your Safety" ([829](#)) and "Caring for the Camera and Battery: Cautions" ([898](#)).

The Battery Charger

- Before charging the battery, connect the EH-7P charging AC adapter to the MH-33 battery charger and plug it into a household power outlet. You can then insert the battery to begin charging.

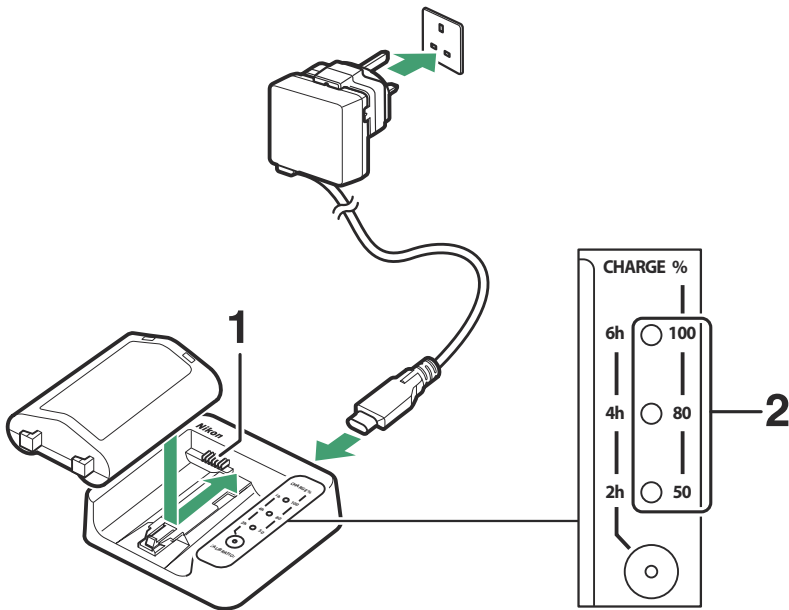

- 1 Signal contacts
- 2 Charge lamps (green)

- The charge lamps flash while charging is in progress and stop flashing as charging completes. Note that depending on the battery charge state, there may be a delay of about ten seconds before the lamps start flashing.
- Insert the battery (terminals first), aligning the end of the battery with the guide and then sliding the battery in the direction indicated until it clicks into place.
- Leave the charger in a location where it will remain stable and free from vibration during use.
- An exhausted battery will fully charge in about 4 hours.
- As charging progresses, the charge lamps will light one at a time until charging is complete and all three lamps are lit.
- Battery status is shown by the charge lamps:

Charge lamps	Charge state			
	<50%	≥50%, <80%	≥80%, <100%	100%
100%	● (off)	● (off)	✳ (flashes)	○ (on)
80%	● (off)	✳ (flashes)	○ (on)	○ (on)
50%	✳ (flashes)	○ (on)	○ (on)	○ (on)

✔ **Caution: Charging EN-EL18d Batteries**

EN-EL18d rechargeable Li-ion batteries are not compatible with MH-26a or MH-26 battery chargers. Be sure to use the MH-33 when charging EN-EL18d batteries via a charger.

✔ **If the Charge Lamps Flash Rapidly**

If the charge lamps flash rapidly (8 times a second):

- **The battery was not inserted correctly:** Unplug the charger and remove and reinsert the battery.
- **The ambient temperature is too hot or too cold:** Use the battery charger at temperatures within the designated temperature range (0–40 °C/+32–104 °F).

If the problem persists, unplug the charger and end charging. Bring the battery and charger to a Nikon-authorized service representative.

The Charging AC Adapter: Charging

When inserted in the camera, the battery can be charged using the supplied EH-7P charging AC adapter.

- After confirming that the camera is off, connect the charging AC adapter (①) and plug the adapter in. The battery will charge while the camera is off. Keep the plug straight during insertion and removal.

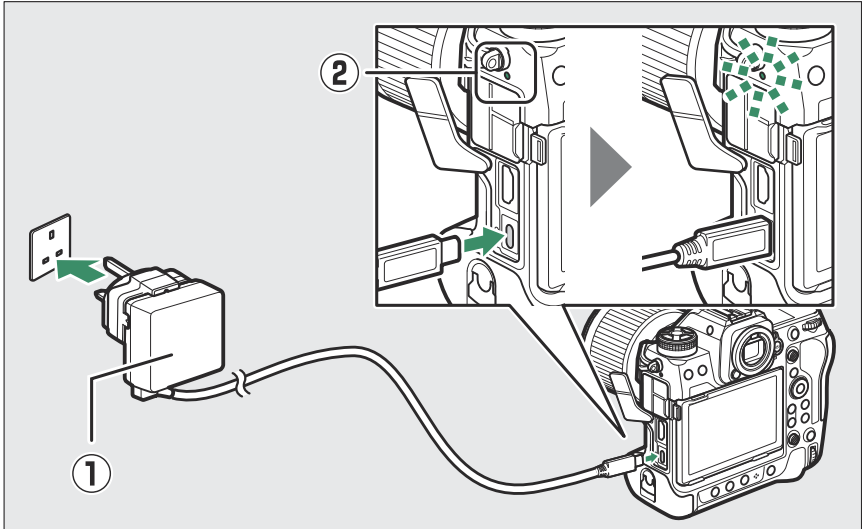

- The camera charge lamp (②) lights amber while charging is in progress. The lamp turns off when charging is complete.
- An exhausted battery will fully charge in about 3 hours and 40 minutes.
- The battery also charges when the standby timer is off.
- When charging is complete, unplug the charging AC adapter and disconnect it from the camera.

✔ Caution: Charging EN-EL18a/EN-EL18 Batteries

The charging AC adapter cannot be used to charge EN-EL18a or EN-EL18 rechargeable Li-ion batteries. Use an MH-26a battery charger.

✔ Caution: The Charging AC Adapter

- If the battery cannot be charged using the charging AC adapter, for example because the battery is not compatible or the temperature of the camera is elevated, the charge lamp will flash rapidly for about 30 seconds and then turn off. If the charge lamp is off and you did not observe the battery charging, turn the camera on and check the battery level.
 - Batteries with a "4" (🔋) showing for **[Battery info]** > **[Battery age]** in the setup menu cannot be charged.
-

Tip: The Charging AC Adapter: Power Delivery

- If **[ON]** is selected for **[USB power delivery]** in the setup menu, the charging AC adapter will supply power to the camera when the camera is on.
- The battery will not charge while the camera is powered by an outside power source.
- For more information, see "'Power Delivery' Versus 'Charging'" ([📖 770](#)).

Tip: Computer USB Power Delivery and Battery Charging

- Computers will supply current to power the camera or charge the battery only when connected via a UC-E25 USB cable (available separately; [📖 880](#)). The supplied USB cable cannot be used for this purpose.
 - Depending on the model and product specifications, some computers will not supply current to power the camera or charge the battery.
-

Inserting the Battery

Turn the camera off before inserting or removing the battery.

1 Remove the BL-7 battery chamber cover.

Lift the battery chamber cover latch, turn it to the open (☞) position (①) and remove the battery chamber cover (②).

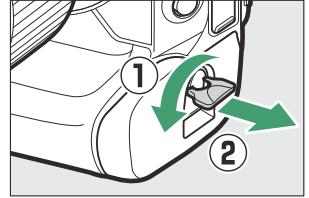

2 Attach the cover to the battery.

- If the battery release is positioned so that the arrow (◀) is visible, slide the battery release to cover the arrow (◀).

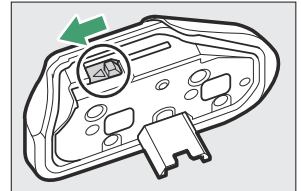

- Insert the two projections on the battery into the matching slots in the cover as shown. The battery release will slide aside to completely reveal the arrow (◀).

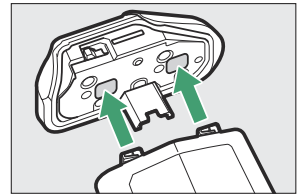

3 Insert the battery.

Insert the battery fully and securely as shown.

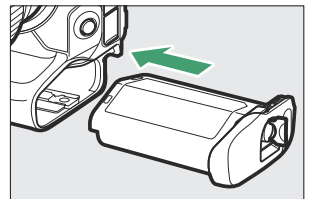

4 Latch the cover.

- Rotate the battery chamber cover latch to the closed position (①) and fold it down as shown (②).

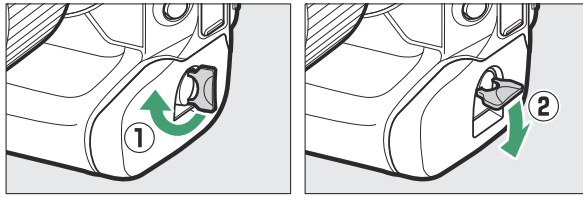

- Be sure the cover is securely latched to prevent the battery from becoming dislodged during operation.

Removing the Battery

Before removing the battery, turn the camera off, lift the battery chamber cover latch, and turn it to the open (Ⓢ) position.

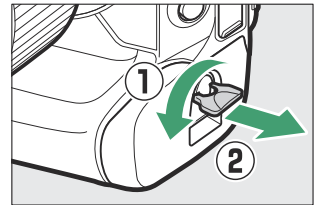

✓ Removing the Battery Chamber Cover

To unlatch the battery chamber cover so that it can be removed from the battery, slide the battery release in the direction indicated by the arrow (◀) until it stops.

✓ The Battery Chamber Cover

- Use BL-7 battery chamber covers only; other battery chamber covers cannot be used with this camera.
- You can leave the cover attached when charging batteries in a charger.
- To prevent dust accumulating inside the battery chamber, replace the battery chamber cover on the camera when the battery is not inserted.

Battery Level

- The battery level is shown in the shooting display and control panel while the camera is on.

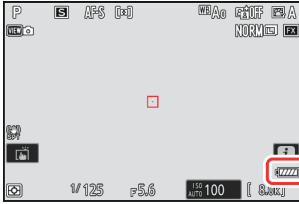

Monitor

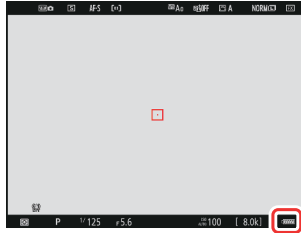

Viewfinder

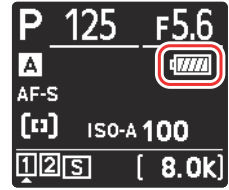

Control panel

- The battery level display changes as the battery level diminishes, from through , , , and . When the battery level falls to , suspend shooting and charge the battery or ready a spare battery.
- If the message [**Shutter release disabled. Recharge battery.**] is displayed, charge or exchange the battery.

The Standby Timer

The camera uses a standby timer to help reduce the drain on the battery. If no operations are performed for about 30 seconds, the standby timer will expire and the monitor, viewfinder, and control panel will turn off. A few seconds prior to turning off, the monitor and viewfinder will dim. They can be reactivated by pressing the shutter-release button halfway. The length of time before the standby timer expires automatically can be selected using Custom Setting c3 [**Power off delay**] > [**Standby timer**].

Inserting Memory Cards

The camera is equipped with two memory card slots (Slots 1 and 2), allowing simultaneous use of two memory cards.

- Turn the camera off before inserting or removing memory cards.
- Holding the memory card in the orientation shown, slide it straight into the slot until it clicks into place.

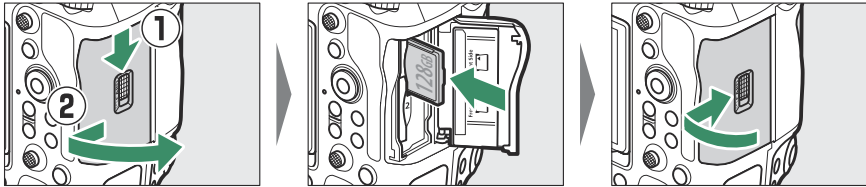

Tip: Number of Exposures Remaining

- The shooting display and control panel show the number of photographs that can be taken at current settings.
- Values over 1000 are rounded down to the nearest hundred. For example, values between 8000 and 8099 are shown as 8.0 k.
- If no memory cards are inserted, an [-E-] indicator will be displayed.

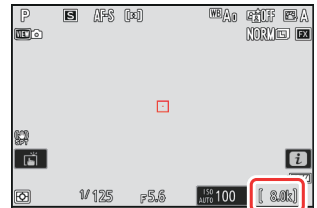

Tip: Slot Icons

The location of the current picture is shown by an icon at the bottom left corner of the playback display.

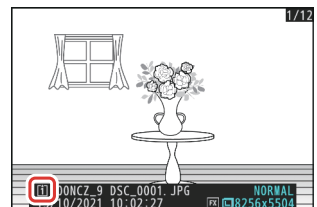

Removing Memory Cards

After confirming that the memory card access lamp is off, turn the camera off, open the memory card slot cover, and press the card in to eject it (①). The card can then be removed by hand (②).

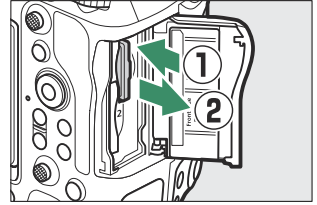

Memory Card High-Temperature Warning

As indicated in the label inside the memory card slot cover, memory cards may become hot while inserted in the camera. Wait for any high-temperature warnings to clear from the shooting display before handling the camera and memory cards.

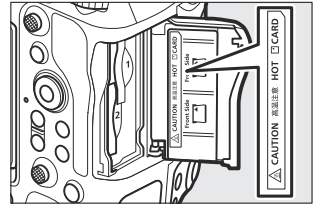

Attaching a Lens

- The camera can be used with Z mount lenses. For more information on lenses, see the lens documentation available from the Nikon Download Center.
 - The lens generally used in this document for illustrative purposes is a NIKKOR Z 50 mm f/1.8 S.
 - Be careful to prevent dust entering the camera.
 - Confirm that the camera is off before attaching the lens.
- Remove the camera body cap (①, ②) and rear lens cap (③, ④).

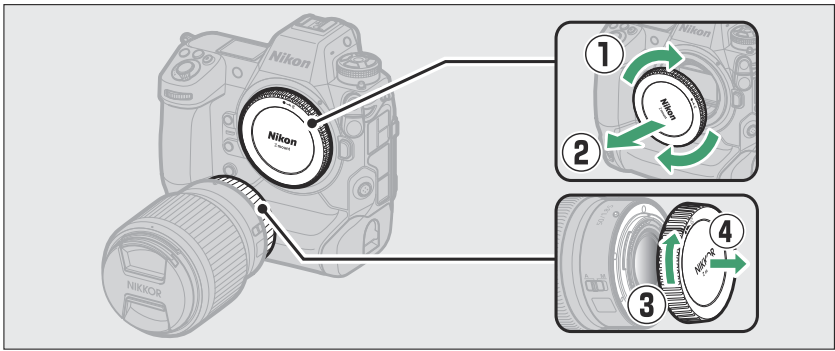

- Align the mounting marks on the camera (⑤) and lens (⑥). Do not touch the image sensor or lens contacts.

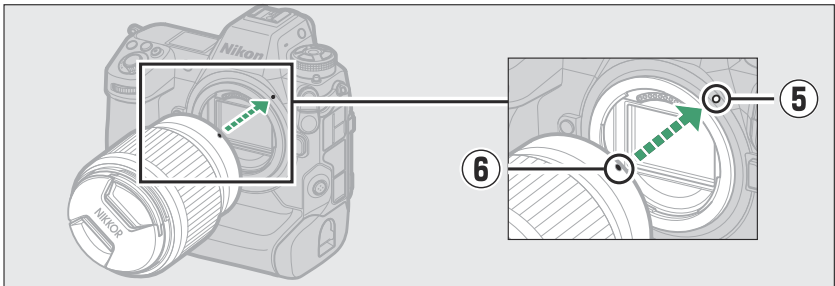

- Rotate the lens as shown until it clicks into place (7).

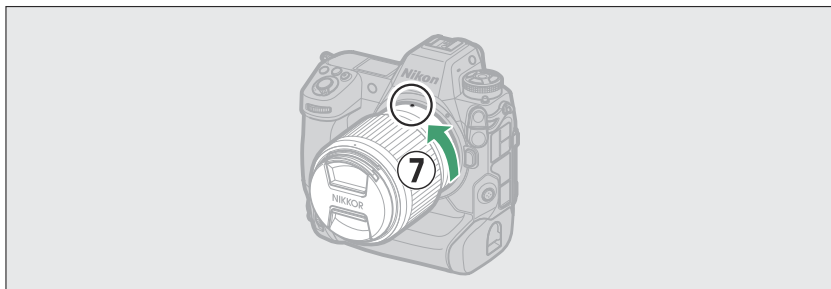

- Remove the front lens cap before taking pictures.

✓ F Mount Lenses

- Be sure to attach an FTZ II or FTZ mount adapter (available separately) to the camera before using F mount lenses ([📖 881](#)).
 - Attempting to attach F mount lenses directly to the camera could damage the lens or image sensor.
-

Detaching Lenses

- After turning the camera off, press and hold the lens release button (①) while turning the lens in the direction shown (②).
- After removing the lens, reattach the lens caps and camera body cap.

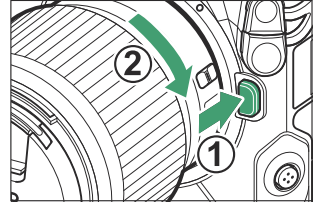

Camera Setup



Turn the camera on, choose a language, and set the clock. Before using the camera for the first time, follow the steps below to choose a language and time zone and set the clock so that the correct time and date will be recorded with any pictures you take.

1 Press MENU, and in the setup menu highlight [Language] and press .

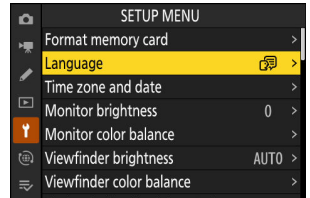
For information on using the menus, see “Using the Menus” ([book 66](#)).



2 Select a language.

Press  or  to highlight the desired language and press  (the languages available vary with the country or region in which the camera was originally purchased).

3 Highlight [Time zone and date] and press .

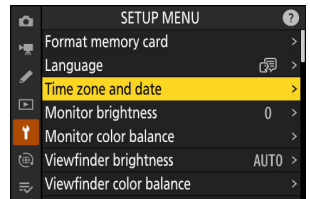

4 Choose a time zone.

- Select [Time zone] in the [Time zone and date] display.
- The display lists selected cities in the chosen zone and the difference between the time in the chosen zone and UTC.
- Highlight a time zone in the [Time zone] display and press .

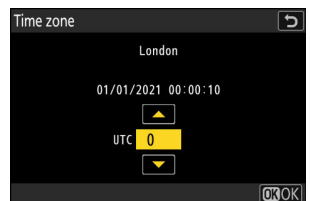

5 Turn daylight saving time on or off.

- Select [**Daylight saving time**] in the [**Time zone and date**] display.
- Select [**ON**] (daylight saving time on) or [**OFF**] (daylight saving time off).
- Selecting [**ON**] advances the clock one hour; to undo the effect, select [**OFF**].

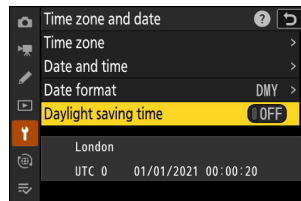

6 Set the clock.

- Select [**Date and time**] in the [**Time zone and date**] display.
- Press \odot after using the multi selector to set the clock to the date and time in the selected time zone in the [**Date and time**] display (note that the camera uses a 24-hour clock).

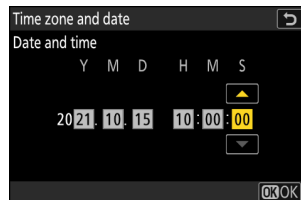

7 Choose a date format.

- Select [**Date format**] in the [**Time zone and date**] display.
- Highlight the desired date (year, month, and day) display order and press \odot .

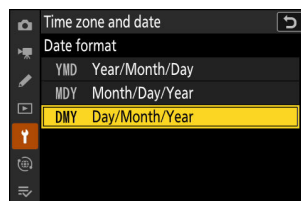

8 Exit the menus.

Lightly press the shutter-release button halfway to exit to shooting mode.

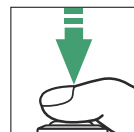

✓ The \odot Icon

A flashing \odot icon in the shooting display indicates that the camera clock has been reset. The date and time recorded with new photographs will not be correct; use the [**Time zone and date**] > [**Date and time**] option in the setup menu to set the clock to the correct time and date. The camera clock is powered by an independent clock battery. The clock battery charges when the main battery is inserted in the camera. It takes about 2 days to charge. Once charged, it will power the clock for about a month.

Basic Photography and Playback

Taking Photographs

The basic steps involved in taking photographs are described below.

✓ Lenses with Retractable Barrels

Lenses with retractable barrels must be extended before use. Rotate the zoom ring as shown until the lens clicks into the extended position.

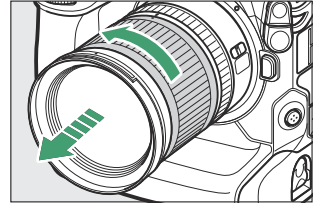

- 1 Select photo mode by rotating the photo/video selector to .

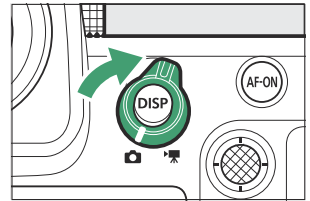

- 2 Ready the camera.

Holding the handgrip in your right hand and cradling the camera body or lens with your left, bring your elbows in against the sides of your chest.



Landscape (wide) orientation



Portrait (tall) orientation

3 Frame the photograph.

Position the main subject near the center of the frame.

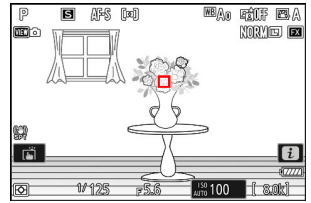

4 To focus, press the shutter-release button halfway (i.e., lightly press the shutter-release button, stopping when it is pressed halfway).

- The focus point will be displayed in green when the camera focuses. If the camera is unable to focus, the focus point will flash red.
- The AF-assist illuminator may light to assist the focus operation if the subject is poorly lit.
- You can also focus by pressing the **AF-ON** button.

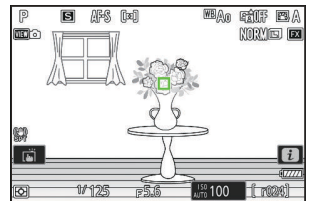
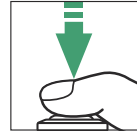

The AF-Assist Illuminator

Do not obstruct the AF-assist illuminator while it is lit.

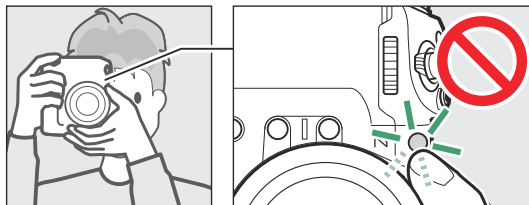

5 Without lifting your finger from the shutter-release button, press the button the rest of the way down to take the picture.

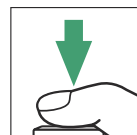

✓ The Memory Card Access Lamp

The memory card access lamp will light while the photograph is being recorded. *Do not remove the memory card or battery.*

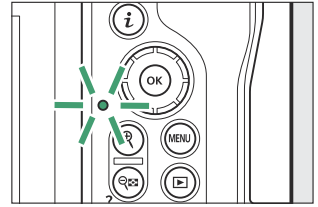

Tip: The Touch Shutter

You can also take a photograph by touching the monitor. Touch your subject to focus and lift your finger to release the shutter ([120](#)).

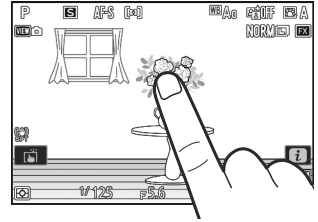

Tip: Framing Photos in Portrait (“Tall”) Orientation

The camera is equipped with controls for use in portrait (“tall”) orientation, including vertical shutter-release, **ISO**, **Fn**, **AF-ON**, and **i** buttons, main and sub-command dials, and a multi selector.

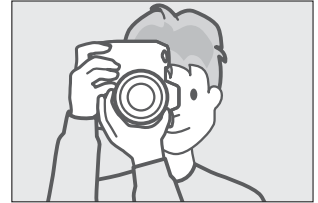

- Rotate the vertical shooting shutter-release button lock to **L** to avoid accidentally operating these controls when the camera is in landscape (“wide”) orientation.

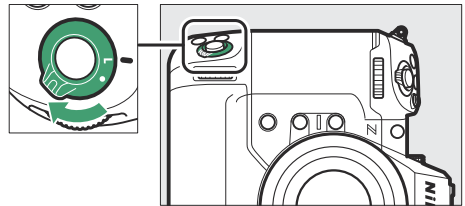

Tip: Using Zoom in Photo Mode

To zoom in on the display in photo mode (to a maximum of approximately 16×), press the **Q** button.

- Use the **Q** and **Q** (?) buttons to zoom in and out.
- A navigation window showing the area currently visible will appear at the bottom right corner of the display.
- Use the multi selector to scroll to areas of the frame not visible in the monitor.

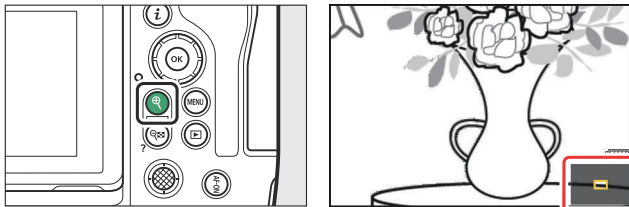

Shooting Videos

The basic steps involved in shooting videos are described below.

- 1 **Select video mode by rotating the photo/video selector to .**

Note that optional flash units cannot be used when the camera is in video mode.

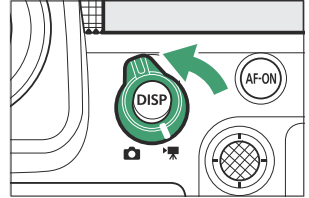

- 2 **Press the video-record button to start recording.**

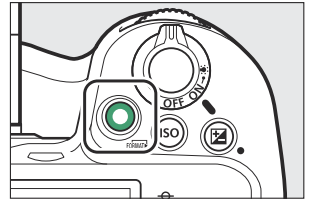

- A recording indicator will be displayed and the borders of the shooting display will turn red. The display also shows the time remaining, or in other words the approximate amount of new footage that can be recorded to the memory card.

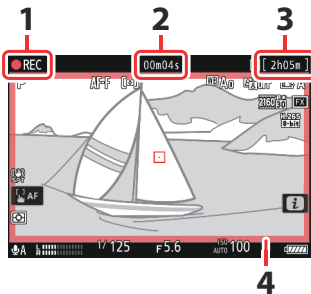

- 1 Recording indicator
- 2 Video recording time (length of footage recorded)
- 3 Time remaining
- 4 Recording indicator (red border)

- The camera can be refocused during recording by pressing the **AF-ON** button.
- Sound is recorded via the video microphone. Do not cover the video microphone during recording.
- You can also focus by tapping your subject in the monitor.

- 3 **Press the video-record button again to end recording.**

✓ The Memory Card Access Lamp

The memory card access lamp will light while the video is being recorded. *Do not remove the memory card or battery.*

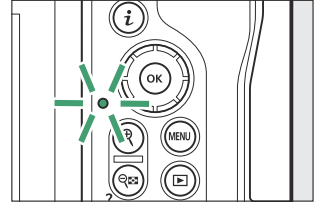

✓ The [Icon] Icon

A [Icon] icon indicates that videos cannot be recorded.

✓ Cautions: Recording Videos

- Video recording will end automatically if:
 - the maximum length is reached,
 - the battery is exhausted,
 - you choose a different shooting mode,
 - you switch modes using the photo/video selector,
 - the lens is removed, or
 - the camera's internal temperature rises.
- Sounds made by the camera may be audible in footage recorded:
 - during autofocus,
 - during vibration reduction, or
 - when power aperture is used.

✓ High-Temperature Warnings

During video recording, the camera or memory cards may become hot and a high-temperature warning or memory card high-temperature warning may appear in the shooting display. Wait for the camera to cool and the warnings to clear from the display before handling the camera, battery, or memory cards.

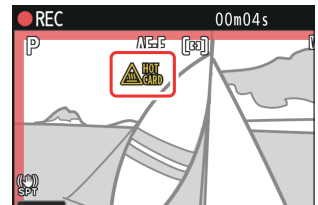



✓ **Cautions: Photography and Video Recording**

- You may notice the following in the shooting display. These phenomena will also be visible in any photos or footage recorded with the camera:
 - flicker or banding in scenes lit by such sources as fluorescent, mercury vapor, or sodium lamps,
 - distortion during motion (individual subjects such as trains or cars moving at high speed through the frame may be distorted, or the entire frame may appear distorted when the camera is panned horizontally),
 - jagged edges, color fringing, moiré, or bright spots,
 - bright regions or bands in scenes lit by flashing signs and other intermittent light sources or when the subject is briefly illuminated by a strobe or other bright, momentary light source, or
 - flicker when power aperture is used during video recording.
 - Note that noise (randomly-spaced bright pixels, fog, or lines) and unexpected colors may appear if you use the  button to zoom in on the view through the lens.
 - When recording, avoid pointing the camera at the sun or other powerful light sources. Failure to observe this precaution could result in damage to the camera's internal circuitry.
-

Tip: Using Zoom in Video Mode

The  button can also be used to zoom in on the display in video mode ([📖 96](#)).

- Press  during recording to zoom in 50%, 100% (1:1), or 200%. To zoom out, press  (?). Note, however, that 50% zoom is not available at a frame size of 1920 × 1080.
 - Zoom is not available during RAW recording ([📖 217](#)).
 - When viewing videos, you can zoom in on the current frame when playback is paused.
-

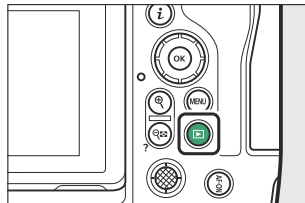

Playback

Press the  button to view photos and videos in the monitor or viewfinder after shooting.

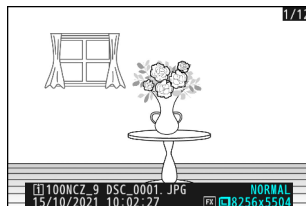

- Press  or  or flick left or right to view additional pictures.



- Videos are indicated by a  icon. Tap the  icon in the display or press the  button to start playback.

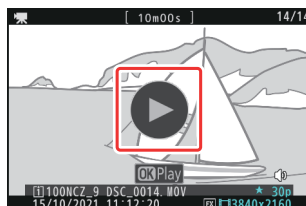

- To end playback and return to shooting mode, press the shutter-release button halfway.

Viewing Videos

The video playback display and controls are described below.

The Video Playback Display

During video playback, the display shows the length of the video, the current playback position, and the other indicators listed below. Your approximate position in the video can also be ascertained from the video progress bar.

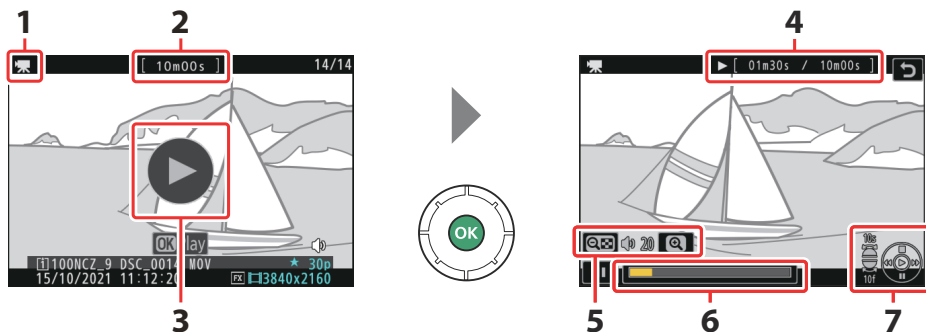















- 1 icon
- 2 Length
- 3 icon

- 4 Current position/total length
- 5 Volume
- 6 Progress bar
- 7 Guide

Video Playback Controls

The following operations can be performed while playback is in progress:



Operation	Description
Pause	Press to pause playback.
Resume	Press the button to resume playback when playback is paused or during rewind/advance.
Rewind/advance	Press to rewind, to advance. Speed increases with each press, from 2x to 4x to 8x to 16x.

Operation	Description
Start slow-motion playback	Press  while the video is paused to start slow-motion playback.
Jog rewind/advance	<ul style="list-style-type: none"> • Press  or  while the video is paused to rewind or advance one frame at a time. • Keep  or  pressed for continuous rewind or advance.
Skip 10 s	Rotate the sub-command dial one stop to skip ahead or back 10 s.
Skip 10 frames	Rotate the main command dial one stop to skip ahead or back 10 frames.
Skip to last or first frame	<ul style="list-style-type: none"> • Keep  or  pressed to skip respectively to the first frame or last frame. • The first frame is indicated by a  in the top right corner of the display, the last frame by a .
Zoom in	Press  to zoom in on the current frame while playback is paused.
Adjust volume	Press  to increase volume,  (?) to decrease.
Edit video	To display video  menu, pause playback and press the  button.
Exit	Press  to exit to full-frame playback.

Deleting Unwanted Pictures

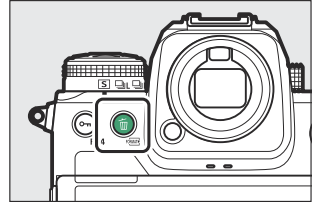
Press the  (DELETE) button to delete the current picture. *Note that pictures cannot be recovered once deleted.*



- Display a picture you want to delete and press the  (DELETE) button to display a confirmation dialog. Press the  (DELETE) button again to delete the picture and return to playback.
- To exit without deleting the picture, press .



Tip: The Playback Menu [Delete] Item

Use [**Delete**] in the playback menu to:

- delete multiple pictures,
 - delete all pictures currently rated  (candidate for deletion),
 - delete all pictures taken on selected dates, or
 - delete all pictures in selected folders.
-

Shooting Settings

Image Recording Options (Image Area, Quality, and Size)

Adjusting Image Area Settings

At default settings, image area can be selected by holding the **Fn2** button and rotating a command dial.

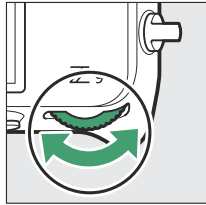
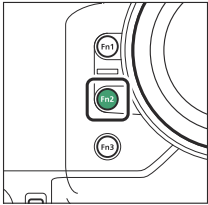



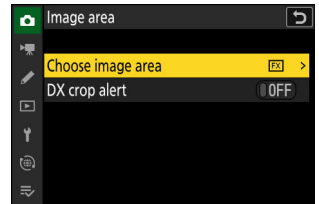

- Image area settings can be displayed by selecting [**Image area**] in the photo shooting menu.



Choose Image Area

Choose the image area. The following options are available:

Option	Description
 [FX (36×24)]	Record pictures in FX format with an angle of view equivalent to a 35 mm format camera.
 [DX (24×16)]	Pictures are recorded in DX format. To calculate the approximate focal length of the lens in 35 mm format, multiply by 1.5. <ul style="list-style-type: none">• Image-area selection is fixed at [DX (24×16)] when a DX lens is attached.
 [1:1 (24×24)]	Pictures are recorded with an aspect ratio of 1:1.
 [16:9 (36×20)]	Pictures are recorded with an aspect ratio of 16:9.

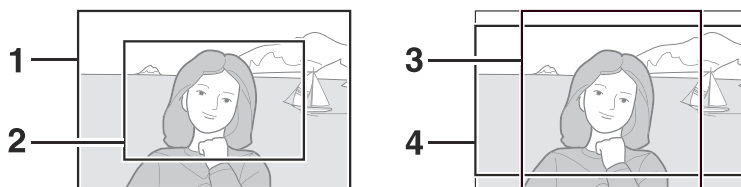

- 1 FX (36×24)
- 2 DX (24×16)
- 3 1:1 (24×24)
- 4 16:9 (36×20)

DX Crop Alert

If **[ON]** is selected for this option in the camera menus, the image area icon in the shooting display will flash when DX (24×16) is selected.

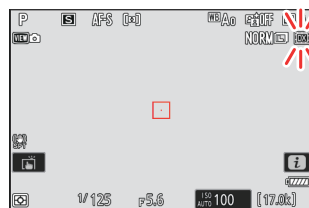

Adjusting Image Quality

Choose the image quality option used when photographs are recorded. Image quality can be adjusted by holding the **QUAL** button and rotating the main command dial.

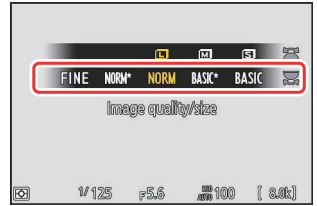
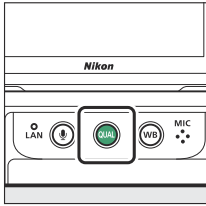

- Image quality can also be adjusted using the **[Image quality]** item in the photo shooting menu.

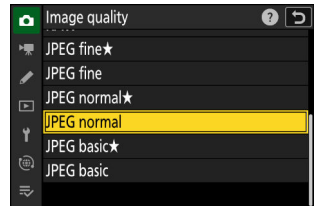

Option	Description
[RAW + JPEG fine★]	Record two copies of each photo: an NEF (RAW) picture and a JPEG copy.
[RAW + JPEG fine]	<ul style="list-style-type: none"> • For the JPEG copy, you can choose from options prioritizing image quality or file size. Choose options with a star ("★") to maximize image quality. Choose options without a star ("★") to ensure that the JPEG copies all have more or less the same file size.
[RAW + JPEG normal★]	<ul style="list-style-type: none"> • Only the JPEG copy is displayed during playback. If only one memory card was inserted in the camera when the photos were recorded, the NEF (RAW) copies can only be viewed using a computer.
[RAW + JPEG normal]	<ul style="list-style-type: none"> • If the photo was recorded with only one memory card inserted or with [Overflow] or [Backup] selected for [Role played by card in Slot 2] and two memory cards inserted, deleting the JPEG copy on the camera will also delete the NEF (RAW) picture.
[RAW + JPEG basic★]	<ul style="list-style-type: none"> • If the photo was recorded with only one memory card inserted or with [Overflow] or [Backup] selected for [Role played by card in Slot 2] and two memory cards inserted, deleting the JPEG copy on the camera will also delete the NEF (RAW) picture.
[RAW + JPEG basic]	<ul style="list-style-type: none"> • If the photo was recorded with only one memory card inserted or with [Overflow] or [Backup] selected for [Role played by card in Slot 2] and two memory cards inserted, deleting the JPEG copy on the camera will also delete the NEF (RAW) picture.
[RAW]	Record photos in NEF (RAW) format.

Option	Description
[JPEG fine★]	Record photos in JPEG format. "Fine" produces higher quality pictures than "normal" and "normal" higher quality pictures than "basic". <ul style="list-style-type: none"> • Choose options with a star ("★") to maximize image quality. Choose options without a star ("★") to ensure that the JPEG copies all have more or less the same file size.
[JPEG fine]	
[JPEG normal★]	
[JPEG normal]	
[JPEG basic★]	
[JPEG basic]	

Tip: NEF (RAW)

- NEF (RAW) files have the extension "*.nef".
- The process of converting NEF (RAW) pictures to other highly-portable formats such as JPEG is referred to as "NEF (RAW) processing". During this process, Picture Controls and settings such as exposure compensation and white balance can be freely adjusted.
- The RAW data themselves are unaffected by NEF (RAW) processing and their quality will remain intact even if the pictures are processed multiple times at different settings.
- NEF (RAW) processing can be performed using **[Retouch] > [RAW processing (current picture)]** or **[RAW processing (multiple pictures)]** in the playback **i** menu or on a computer using Nikon's NX Studio software. NX Studio is available free-of-charge from the Nikon Download Center.

Tip: "NEF (RAW) + JPEG"

If **[RAW Slot 1 - JPEG Slot 2]** is selected for **[Role played by card in Slot 2]**, the NEF (RAW) copies will be recorded to the card in Slot 1 and the JPEG copies to the card in Slot 2 ([link 447](#)).

Adjusting Image Size Settings

Image size can be adjusted by holding the **QUAL** button and rotating the sub-command dial.

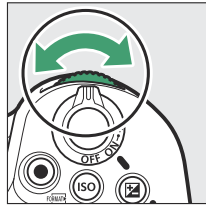
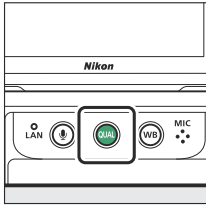

- Image size settings can be adjusted using the **[Image size settings]** item in the photo shooting menu.

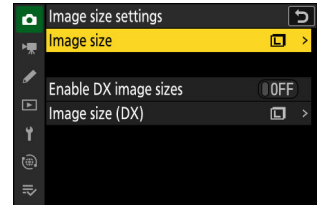
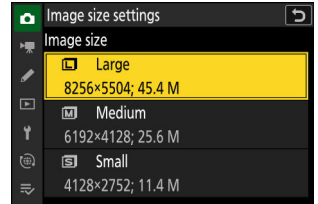

Image Size

Choose a size for new JPEG pictures. The size for JPEG pictures can be selected from **[Large]**, **[Medium]**, and **[Small]**.



The number of pixels in the picture varies with the option selected for image area ([104](#)).

Image area	Image size	Size when printed at 300 dpi
[FX (36×24)]	Large (8256 × 5504 pixels)	Approx. 69.9 × 46.6 cm/27.5 × 18.3 in.
	Medium (6192 × 4128 pixels)	Approx. 52.4 × 35.0 cm/20.6 × 13.8 in.
	Small (4128 × 2752 pixels)	Approx. 35.0 × 23.3 cm/13.8 × 9.2 in.
[DX (24×16)]	Large (5392 × 3592 pixels)	Approx. 45.7 × 30.4 cm/18.0 × 12.0 in.
	Medium (4032 × 2688 pixels)	Approx. 34.1 × 22.8 cm/13.4 × 9.0 in.
	Small (2688 × 1792 pixels)	Approx. 22.8 × 15.2 cm/9.0 × 6.0 in.

Image area	Image size	Size when printed at 300 dpi
[1:1 (24×24)]	Large (5504 × 5504 pixels)	Approx. 46.6 × 46.6 cm/18.3 × 18.3 in.
	Medium (4128 × 4128 pixels)	Approx. 35.0 × 35.0 cm/13.8 × 13.8 in.
	Small (2752 × 2752 pixels)	Approx. 23.3 × 23.3 cm/9.2 × 9.2 in.
[16:9 (36×20)]	Large (8256 × 4640 pixels)	Approx. 69.9 × 39.3cm/27.5 × 15.5 in.
	Medium (6192 × 3480 pixels)	Approx. 52.4 × 29.5 cm/20.6 × 11.6 in.
	Small (4128 × 2320 pixels)	Approx. 35.0 × 19.6 cm/13.8 × 7.7 in.

Tip: Print Size

Print size in inches equals image size in pixels divided by printer resolution in dots per inch (dpi); 1 inch = 2.54 cm).

Enable DX Image Sizes

Selecting **[ON]** allows the size for photos taken using the **[DX (24×16)]** image area to be chosen separately from that for pictures taken using other image areas.

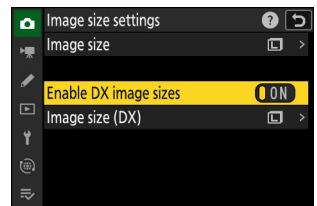
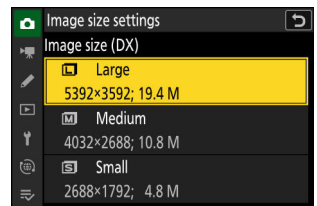

Image Size (DX)

Choose the size of photographs taken using the **[DX (24×16)]** image area when **[ON]** is selected for **[Enable DX image sizes]**.



Focus

Focus Mode

Control how the camera focuses.

Choosing a Focus Mode

The focus mode can be selected by holding the focus-mode button and rotating the main command dial.

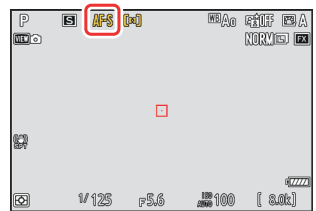
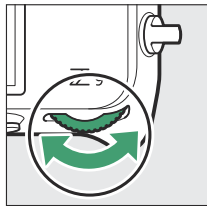
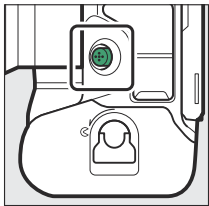

Tip: [Focus Mode]

The focus mode can also be selected using the [Focus mode] items in the photo shooting and video recording menus.

Option		Description
AF-S	[Single AF]	<ul style="list-style-type: none">• Use with stationary subjects. When you press the shutter-release button halfway to focus, the focus point will turn from red to green and focus will lock. If the camera fails to focus, the focus point will flash red and the shutter release will be disabled.• At default settings, the shutter can only be released if the camera is able to focus (focus priority).
AF-C	[Continuous AF]	<ul style="list-style-type: none">• Use for shots of athletes and other moving subjects. The camera adjusts focus continuously in response to changes in the distance to the subject while the shutter-release button is pressed halfway.• At default settings, the shutter can be released whether or not the subject is in focus (release priority).

Option		Description
AF-F	[Full-time AF]	<ul style="list-style-type: none"> • The camera adjusts focus continuously in response to subject movement or changes in composition. • When you press the shutter-release button halfway to focus, the focus point will turn from red to green and focus will lock. • This option is only available in video mode.
MF	[Manual focus]	Focus manually (📖 124). The shutter can be released whether or not the subject is in focus.

✔ Cautions: Autofocus

- The camera may be unable to focus if:
 - the subject contains lines parallel to the long edge of the frame,
 - the subject lacks contrast,
 - the subject in the focus point contains areas of sharply contrasting brightness,
 - the focus point includes night-time spot lighting or a neon sign or other light source that changes in brightness,
 - flicker or banding appears under fluorescent, mercury-vapor, sodium-vapor, or similar lighting,
 - a cross (star) filter or other special filter is used,
 - the subject appears smaller than the focus point, or
 - the subject is dominated by regular geometric patterns (e.g., blinds or a row of windows in a skyscraper).
- The display may brighten or darken while the camera focuses.
- The focus point may sometimes be displayed in green when the camera is unable to focus.
- The camera may take longer to focus when lighting is poor.

Tip: Low-Light AF

For improved focus when shooting under low light, select **[ON]** for Custom Setting d10 **[Starlight view (photo Lv)]**. This option takes effect only in photo mode.

AF-Area Mode

Choose how the camera selects the focus point for autofocus.

- In modes other than **[Auto-area AF]**, the focus point can be positioned using the sub-selector ([book 119](#)) or multi selector.



Choosing an AF-Area Mode

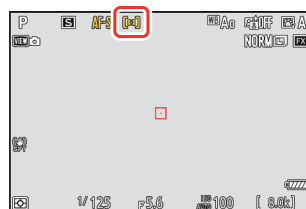
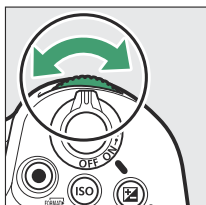
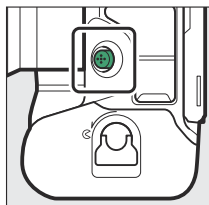



To choose the AF-area mode, hold the focus-mode button and rotate the sub-command dial.













Tip: [AF-Area Mode]

The AF-area mode can also be selected using the **[AF-area mode]** items in the photo shooting and video recording menus.

Option	Description
 [Pinpoint AF]	<ul style="list-style-type: none">• With a focus point smaller than that employed for single-point AF, pinpoint AF is used for pinpoint focus on a selected spot in the frame.• Focusing may be slower than with single-point AF.• Recommended for shots involving static subjects, such as buildings, in-studio product photography, or close-ups.• This option is only available when photo mode is selected and [Single AF] is chosen for focus mode.
 [Single-point AF]	<ul style="list-style-type: none">• The camera focuses on a point selected by the user.• Use with stationary subjects.

Option		Description
 [Dynamic-area AF (S)]		<ul style="list-style-type: none"> • The camera focuses on a point selected by the user. If the subject briefly leaves the selected point, the camera will focus based on information from surrounding focus points. • This option is only available when photo mode is selected and [Continuous AF] is chosen for focus mode. • Use for photographs of athletes and other active subjects that are hard to frame using single-point AF. • The size of the area used for focus can be selected from S (small), M (medium), and L (large). S is the smallest and L the largest.
 [Dynamic-area AF (M)]		
 [Dynamic-area AF (L)]		
 [Wide-area AF (S)]		<ul style="list-style-type: none"> • As for single-point AF except that the camera focuses on a wider area. • Choose for snapshots, subjects that are in motion, and other subjects that are difficult to photograph using single-point AF. • During video recording, wide-area AF can be used for smooth focus when making panning or tilting shots or filming moving subjects. • If the selected focus point contains subjects at different distances from the camera, the camera will assign priority to the closest subject. • The focus points for [Wide-area AF (L)] are larger than those for [Wide-area AF (S)].
 [Wide-area AF (L)]		

Option		Description
	[Wide-area AF (C1)]	<p>Choose the dimensions (measured in focus points) of the focus areas used for the selected AF-area.</p> <ul style="list-style-type: none"> • This can be used, for example, if the size and shape of the area employed for focus can be determined in advance with a fair degree of accuracy. • On selecting [Wide-area AF (C1)] or [Wide-area AF (C2)], you will be prompted to choose the AF-area size. Use  and  to choose the height and  and  to choose the width. • The photo shooting menu offers a choice of 20 options ranging from [1×1] to [19×11] and the video recording menu a choice of 12 options ranging from [1×1] to [13×7].
	[Wide-area AF (C2)]	
	[3D-tracking]	<ul style="list-style-type: none"> • The camera tracks focus on a selected subject. • Position the focus point over your subject and start tracking by pressing AF-ON or by pressing the shutter-release button halfway; focus will then track the selected subject as it moves through the frame. Release the button to end tracking and restore the previously-selected focus point. • If the subject leaves the frame, remove your finger from the shutter-release button and recompose the photograph with the subject in the selected focus point. • This option is only available when photo mode is selected and [Continuous AF] is chosen for focus mode.
	[Subject-tracking AF]	<ul style="list-style-type: none"> • Track focus on a selected subject. • Position the reticle over the target and start tracking by pressing the shutter-release button halfway or by pressing  or AF-ON; the focus point will track the selected subject as it moves through the frame. To end tracking and select the center focus point, press . • This option is only available in video mode.
	[Auto-area AF]	<ul style="list-style-type: none"> • The camera automatically detects the subject and selects the focus point. • Use on occasions when you don't have time to select the focus point yourself, for portraits, or for snapshots and other spur-of-the-moment photos.

✓ **Caution: 3D-Tracking and Subject Tracking**





The camera may be unable to track subjects that:

- are similar in color, brightness, or pattern to the background,
 - change visibly in size, color, or brightness,
 - are too large or too small,
 - are too bright or too dark,
 - move quickly, or
 - are obscured by other objects or leave the frame.
-

Tip: : **The Center Focus Point**

In all AF-area modes except [**Auto-area AF**], [**3D-tracking**], and [**Subject-tracking AF**], a dot appears in the focus point when it is in the center of the frame.

Tip: Choosing the AF-Area Size: “Wide-Area AF (C1)” and “Wide-Area AF (C2)”

When [**Wide-area AF (C1)**] or [**Wide-area AF (C2)**] is selected for [**AF-area mode**], the size of the focus area can be chosen by holding the focus-mode button and pressing , , , and .

Tip: Quick Focus-Point Selection

- For quicker focus-point selection, choose [**Alternating points**] for Custom Setting a4 [**Focus points used**] to use only a quarter of the available focus points. Selecting [**Alternating points**] does not affect the number of points available for [**Pinpoint AF**].
 - If you prefer to use the sub-selector for focus-point selection, you can choose [**Select center focus point**] for Custom Setting f2 [**Custom controls (shooting)**] > [**Sub-selector center**] to allow the center of the sub-selector to be used to quickly select the center focus point.
-

Choosing a Subject Type for Autofocus

The class of subjects given priority during autofocus can be chosen using the **[AF subject detection options]** items in the photo shooting and video recording menus, which offer a choice of **[Auto]**, **[People]**, **[Animal]**, **[Vehicle]**, and **[Subject detection off]**. The subject detected by the camera is indicated by a focus point.

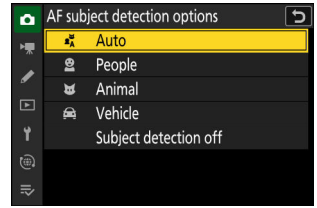

- In the case of the video recording menu, the choice of subject is made via **[AF subject detection options]** > **[Subject detection]**. Separate subject types can be selected for photo and video modes.
- Subject detection is available when **[Wide-area AF (S)]**, **[Wide-area AF (L)]**, **[Wide-area AF (C1)]**, **[Wide-area AF (C2)]**, **[3D-tracking]**, **[Subject-tracking AF]**, or **[Auto-area AF]** is selected for **[AF-area mode]**.
- Human faces detected by the camera when **[People]** is selected are identified by a border indicating the focus point. If the camera detects the subject's eyes, the focus point will instead appear over one or the other of their eyes (face/eye-detection AF). If the subject looks away after their face is detected, the focus point will move to track their motion.
- If a dog, cat, or bird is detected when **[Animal]** is selected, the focus point will appear over the face of the animal in question (animal-detection AF). If the camera detects the subject's eyes, the focus point will instead appear over one or the other of their eyes. If the camera can detect neither face nor eyes, it will display a focus point over the detected animal.
- If a car, motorcycle, train, airplane, or bicycle is detected when **[Vehicle]** is selected, the focus point will appear over the vehicle in question. In the case of trains, the camera will detect only the front end. With planes, the camera will detect the body, nose, or cockpit depending on the aircraft's size.



- If **[Auto]** is selected, the camera will detect humans, animals, and vehicles and choose a subject for focus automatically.
- To disable AF subject detection altogether, choose **[Subject detection off]**.
- If more than one subject of the selected type is detected, a gray focus point will appear over each of the subjects detected. If **[Auto-area AF]** is selected for **[AF-area mode]**, ◀ and ▶ icons will appear on the focus point selected by the camera. The focus point can be positioned over the other subjects by pressing ◀ or ▶.
- During playback, you can zoom in on the subject used for focus by pressing ⓧ.

✔ **Caution: Face/Eye-Detection AF**

Subject detection may not perform as expected if:

- the subject's face is too large or small relative to the frame,
- the subject's face is too brightly or dimly lit,
- the subject is wearing glasses or sunglasses,
- the subject's face or eyes are obscured by hair or other objects, or
- the subject moves excessively during shooting.

✔ **Cautions: Animal-Detection AF**

- Subject detection may not perform as expected if:
 - the subject's face is too large or small relative to the frame,
 - the subject's face is too brightly or dimly lit,
 - the subject's face or eyes are obscured by fur or the like,
 - the subject's face and eyes are of similar colors, or
 - the subject moves excessively during shooting.
- The camera may display a border around subjects that are not dogs, cats, or birds but which resemble these animals.
- The light from the AF-assist illuminator may adversely affect the eyes of some animals; when using animal-detection AF, select **[OFF]** for Custom Setting a12 **[Built-in AF-assist illuminator]**.

✔ **Cautions: Vehicle-Detection AF**

- Subject detection may not perform as expected with subjects that are:
 - too large or small relative to the frame,
 - too bright or too dark,
 - partially hidden,
 - similar in color to surrounding objects, or
 - moving excessively.
- The camera may fail to detect vehicles of some shapes and colors. Alternatively, it may display a border around subjects that are not vehicles.

✔ **Subject Detection**

The performance of subject-detection may drop:

- during high-speed frame capture + or
 - if either **[HLG]** or **[N-Log]** is selected as the tone mode for **[Video file type] > [ProRes 422 HQ 10-bit (MOV)]** or **[H.265 10-bit (MOV)]** in the video recording menu.
-

Focus Point Selection

Except when [Auto-area AF] is selected for AF-area mode, the focus point can be selected manually, allowing photographs to be composed with the subject positioned almost anywhere in the frame.

- Use the multi selector to select the focus point while the standby timer is on.
- Pressing  selects the center focus point.

Tip: The Sub-Selector

- The sub-selector can be used for focus-point selection in place of the multi selector.
- Exposure and focus lock while the center of the sub-selector is pressed.
- Be careful not to put your fingers in your eye while using the sub-selector with your eye to the viewfinder.

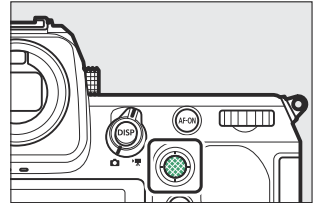

Tip: Portrait (“Tall”) Orientation

You may find it convenient to use the vertical multi selector when taking photographs in portrait (“tall”) orientation.

Tip: Using the Sub-Selector and Vertical Multi Selector

You can press the centers of the sub-selector and vertical multi selector or tilt them as shown. The controls may not function as expected when pressed from the side.



Tip: Focus-Point Lock

Focus-point selection can be locked by choosing [ON] for Custom Setting f4 or g3 [Control lock] > [Focus-point lock].



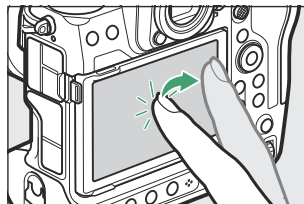

The Touch Shutter

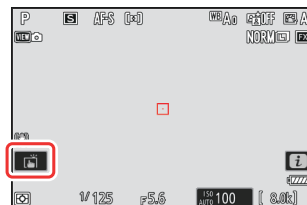

Touch the display to focus on the selected point. The shutter will be released when you lift your finger from the display.



Tap the icon shown in the illustration to choose the operation performed by tapping the display.



	Option	Description
	[Touch shutter/touch AF]	<ul style="list-style-type: none"> • Touch the display to focus on the selected point and lift your finger to release the shutter. • When choosing an eye using touch controls, note that the camera may not focus on the eye on the side you intend. Use the multi selector to choose the desired eye. • If [Auto-area AF] is selected for AF-area mode, the camera will focus on the chosen point, release the shutter, and track the selected subject. Press  to end subject tracking. • Available only in photo mode.
	[Off]	Touch shutter disabled.
	[Position focus point]	<ul style="list-style-type: none"> • Touch the display to position the focus point. The camera will not focus and lifting your finger from the display will not release the shutter. • If [Subject-tracking AF] or [Auto-area AF] is selected for AF-area mode, focus will track the subject at the chosen point. Press  to end subject tracking.

	Option	Description
	[Touch AF]	<ul style="list-style-type: none"> • Touch the display to focus on the selected point. Lifting your finger from the display does not release the shutter. • If [Subject-tracking AF] or [Auto-area AF] is selected for AF-area mode, the camera will focus on and track the subject at the chosen point. Press  to end subject tracking.

Cautions: Taking Pictures Using Touch Shooting Options

- Touch controls cannot be used for manual focus.
- The shutter-release button can be used to take pictures when the  icon is displayed.
- During burst photography, touch controls can be used only to take one picture at a time. Use the shutter-release button for burst photography.
- In self-timer mode, focus locks on the selected subject when you touch the monitor and the shutter is released about 10 seconds after you lift your finger from the display. If the number of shots selected is greater than 1, the remaining shots will be taken in a single burst.

Focus Lock

Use focus lock in cases in which the camera has trouble focusing with autofocus.

- Use focus lock to lock focus on the current subject when **AF-C** is selected for focus mode.
- When using focus lock, choose an AF-area mode other than **[Auto-area AF]**.

1 Position the subject in the selected focus point and press the shutter-release button halfway.

2 Press the center of the sub-selector.

- Keeping the shutter-release button pressed halfway (①), press the center of the sub-selector (②) to lock focus. Focus will remain locked while the center of the sub-selector is pressed, even if you lift your finger from the shutter-release button.
- Exposure will also lock.

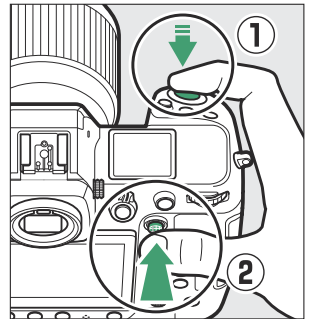

- **AE-L** icons will appear in the displays.

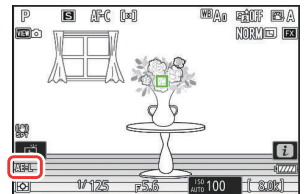

3 Keeping the center of the sub-selector pressed, recompose the photograph and shoot.

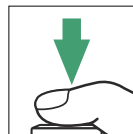

Do not change the distance between the camera and the subject. If the distance to the subject changes, release the lock and focus again at the new distance.

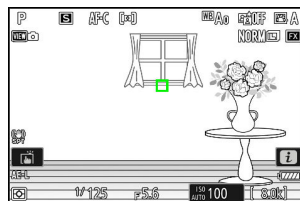

✓ Locking Focus When AF-S Is Selected for Focus Mode

Focus locks while the shutter-release button is pressed halfway. You can also lock focus by pressing the center of the sub-selector.

✓ Taking Multiple Shots at the Same Focus Distance

- If you locked focus by pressing the center of the sub-selector, focus will remain locked between shots if you keep the center of the sub-selector pressed.
- If you locked focus by pressing the shutter-release button halfway, focus will remain locked if you keep the button pressed halfway between shots.

Tip: Locking Focus with the AF-ON Button

- The **AF-ON** button can be used for focus in place of the shutter-release button.
 - When [**AF-ON only**] is selected for Custom Setting a6 [**AF activation**], focus can be initiated only by pressing the **AF-ON** button; the camera will not focus when the shutter-release button is pressed halfway. Focus locks after the **AF-ON** button is released. To end focus lock, press the **AF-ON** button again.
-

Manual Focus

Manual focus is available in manual focus mode. Use manual focus when, for example, autofocus does not produce the desired results.

- Position the focus point over your subject and rotate the focus or control ring until the subject is in focus.

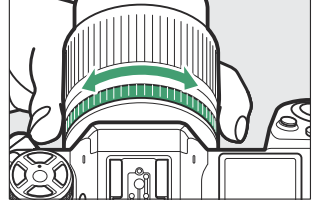

- For greater precision, press the  button to zoom in on the view through the lens.

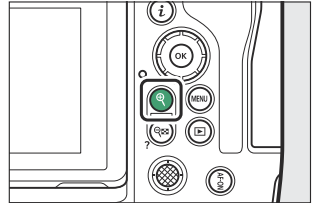

- The focus indicator (●) in the shooting display can be used to confirm whether the subject in the selected focus point is in focus (electronic rangefinding). The focus point will also light green when the subject is in focus.

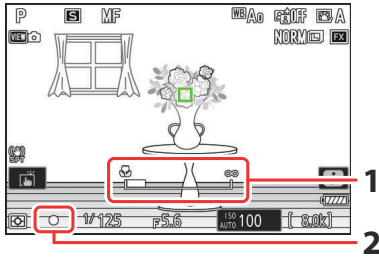

- 1 Focus distance indicator
- 2 Focus indicator

Focus indicator	Description
● (steady)	The subject is in focus.
▶ (steady)	The focus point is in front of the subject.
◀ (steady)	The focus point is behind the subject.
▶ ◀ (flashes)	The camera is unable to focus.

- When using manual focus with subjects not suited to autofocus, note that the in-focus indicator (●) may be displayed when the subject is not in focus. Zoom in on the view through the lens and check focus. Use of a tripod is recommended when the camera is having trouble focusing.

✓ Lenses with Focus-Mode Selection

Manual focus mode can be chosen using focus-mode selection controls on the lens (where available).

✓ The Focal Plane Mark and Flange-Back Distance

Focus distance is measured from the focal plane mark (↔) on the camera body, which shows the position of the focal plane inside the camera (①). Use this mark when measuring the distance to your subject for manual focus or macro photography. The distance between the focal plane and the lens mounting flange is known as the “flange-back distance” (②). On this camera, the flange-back distance is 16 mm (0.63 in.).

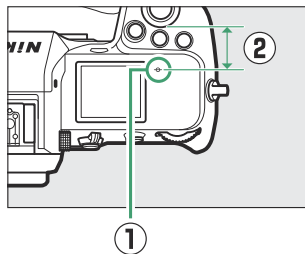

Tip: Focus Peaking

- If [ON] is selected for Custom Setting a13 [Focus peaking] > [Focus peaking display], objects that are in focus will be indicated by colored outlines that appear when focus is adjusted manually (focus peaking).
- Note that the focus peaking display may not appear if the camera is unable to detect outlines. Check focus in the shooting display.

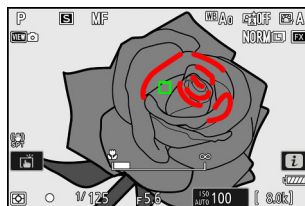

Exposure

Choosing a Shooting Mode

To choose a shooting mode, hold the **MODE** button and rotate the main command dial. The selected option is shown in the shooting display and control panel.

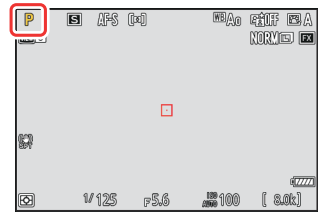
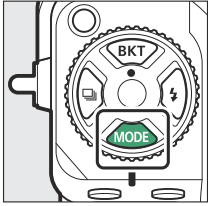

	Mode	Description
P	Programmed auto (book 128)	Use for snapshots and in other situations in which there is little time to adjust camera settings. The camera chooses both shutter speed and aperture automatically.
S	Shutter-priority auto (book 128)	Use to freeze or blur motion. You choose the shutter speed; the camera adjusts aperture automatically.
A	Aperture-priority auto (book 128)	Use to blur backgrounds or bring both foreground and background into focus. You choose the aperture; the camera adjusts shutter speed automatically.
M	Manual (book 129)	You control both shutter speed and aperture. Choose a shutter speed of "Bulb" or "Time" for long time-exposures.

P (Programmed Auto)

- In this mode, the camera automatically adjusts shutter speed and aperture according to a built-in program to ensure optimal exposure in most situations.
- Different combinations of shutter speed and aperture that produce the same exposure can be selected by rotating the main command dial (“flexible program”).

- While flexible program is in effect, a flexible program indicator (✳) is displayed.
- To restore default shutter speed and aperture settings, rotate the main command dial until the indicator is no longer displayed. Flexible program can also be ended by choosing another mode or turning the camera off.

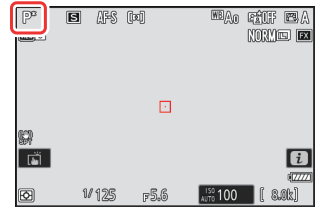

S (Shutter-Priority Auto)

- In shutter-priority auto, you choose the shutter speed while the camera automatically adjusts aperture for optimal exposure. Choose fast shutter speeds to “freeze” motion, slow shutter speeds to suggest motion by blurring moving objects.
- Rotate the main command dial to set the shutter speed.
- Shutter speed can be set to values between $1/32000$ s and 30 s.
- Shutter speed can be locked at the selected value ([book 660](#), [book 683](#)).

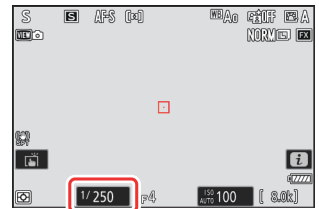

A (Aperture-Priority Auto)

- In aperture-priority auto, you choose the aperture while the camera automatically adjusts shutter speed for optimal exposure.
- Aperture can be adjusted by rotating the sub-command dial.
- The minimum and maximum values for aperture vary with the lens.
- Aperture can be locked at the selected value ([book 660](#), [book 683](#)).

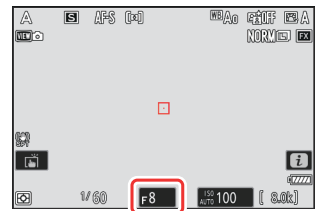

M (Manual)

- You control both shutter speed and aperture. Choose this mode for long time-exposures of such subjects as fireworks or the night sky (“Bulb” or “Time” photography, [link 132](#)).
- Shutter speed and aperture can be adjusted with reference to the exposure indicators by rotating the command dials.
- Rotate the main command dial to choose the shutter speed. Shutter speed can be set to values between $\frac{1}{32000}$ s and 30 s or to “Bulb” or “Time”.

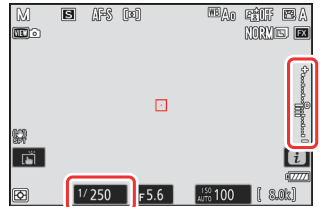

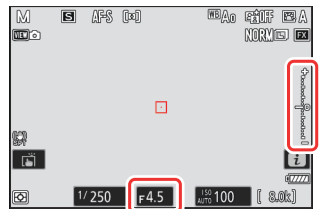

- Aperture can be adjusted by rotating the sub-command dial.
- The minimum and maximum values for aperture vary with the lens.
- Shutter speed and aperture can be locked at the selected values ([link 660](#), [link 683](#)).

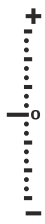
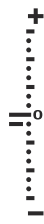
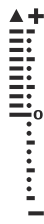
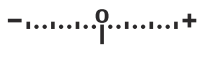

✓ Exposure Indicators

The exposure indicators in the monitor, viewfinder, and control panel show whether the photograph would be under- or over-exposed at current settings. The exposure indicators can be read as follows (the display varies with the option selected for Custom Setting b2 [**EV steps for exposure cntrl**]):

Display	[1/3 step] selected for [EV steps for exposure cntrl]		
	Optimal exposure	Underexposed by $\frac{1}{3}$ EV	Overexposed by over $3\frac{1}{3}$ EV
Monitor			
Viewfinder/ control panel			

The orientation of the exposure indicators can be reversed using Custom Setting f7 [**Reverse indicators**].

✓ Exposure Warning

The displays will flash if the selected settings exceed the limits of the exposure metering system.

Tip: Extended Shutter Speeds

For shutter speeds as slow as 900 s (15 minutes), select **[ON]** for Custom Setting d6 **[Extended shutter speeds (M)]**.

Tip: Long Exposures

At speeds slower than 1 s, the shutter speed displayed by the camera may differ from the actual exposure time. The actual exposure times at shutter speeds of 15 and 30 seconds, for example, are respectively 16 and 32 seconds. The exposure time will again match the selected shutter speed at speeds of 60 seconds and slower.

Tip: Auto ISO Sensitivity Control (Mode M)

If auto ISO sensitivity control ([📖 149](#)) is enabled, ISO sensitivity will automatically be adjusted for optimal exposure at the selected shutter speed and aperture.

Long Time-Exposures (Mode M Only)

The camera offers two options for long time-exposures: “Bulb” and “Time”. Long time-exposures can be used for pictures of fireworks, night scenery, the stars, or moving lights.



A 35-second exposure shot at a shutter speed of “Bulb” and an aperture of f/25

Shutter speed	Description
Bulb	The shutter remains open while the shutter-release button is held down.
Time	The exposure starts when the shutter-release button is pressed and ends when the button is pressed a second time.

1 Keep the camera steady, for example by using a tripod.

2 Hold the MODE button and rotate the main command dial to select mode M.

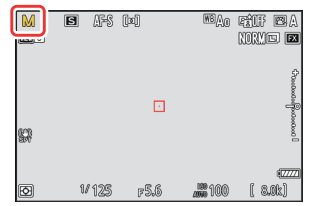
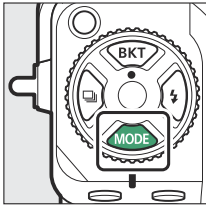

3 Rotate the main command dial to choose a shutter speed of Bulb (“Bulb”) or Time (“Time”).

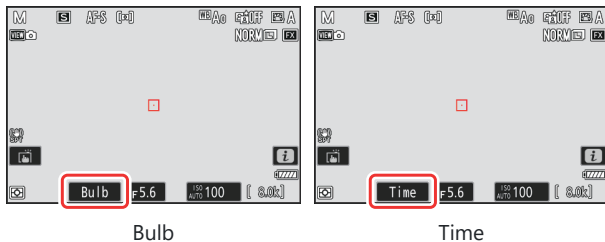

Note that the exposure indicators are not displayed at a shutter speed of **Bulb** or **Time**.

4 Focus and start the exposure.

- **“Bulb”**: Press the shutter-release button all the way down to start the exposure. Keep the shutter-release button pressed during the exposure.
- **“Time”**: Press the shutter-release button all the way down to start the exposure.
- The elapsed time is shown in the control panel.

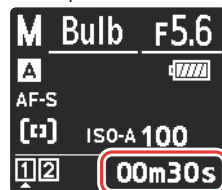

5 End the exposure.

- **“Bulb”**: Lift your finger from the shutter-release button.
- **“Time”**: Press the shutter-release button all the way down a second time.

✓ Long Time-Exposures

- Note that “noise” (bright spots, randomly-spaced bright pixels or fog) may be present in long exposures.
 - Bright spots and fog can be reduced by choosing **[ON]** for **[Long exposure NR]** in the photo shooting menu.
 - Nikon recommends using a fully-charged battery, the supplied charging AC adapter, or an optional AC adapter and power connector to prevent loss of power during long exposures.
 - To prevent blur, use of a tripod or a device such as an optional remote cord or wireless remote controller is recommended.
-

Autoexposure Lock

Use autoexposure lock to recompose photographs after setting exposure for a specific area of the subject. Exposure lock comes in handy when the area used to set exposure is much brighter or darker than its surroundings.

1 With the subject positioned in the selected focus point and the shutter-release button pressed halfway, press the center of the sub-selector to lock exposure.

- While the center of the sub-selector is pressed, exposure will lock at the value metered in an area of the subject determined by the selected metering option.

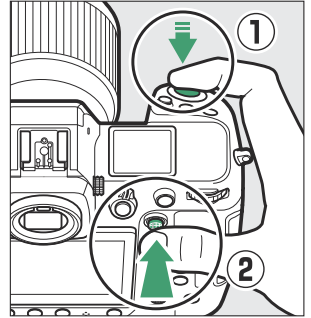

- An **AE-L** icon will appear in the shooting display.
- If autofocus is enabled, focus will also lock.

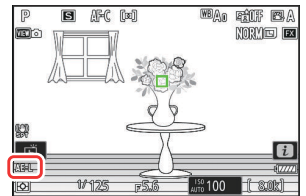

2 Keeping the center of the sub-selector pressed, recompose the photograph and shoot.

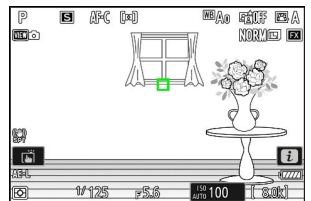
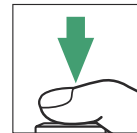

Tip: Locking Exposure with the Shutter-Release Button

If [**On (half press)**] is selected for Custom Setting c1 [**Shutter-release button AE-L**], exposure will lock while the shutter-release button is pressed halfway.

Tip: Metered Area

- With [**Spot metering**], exposure will be locked at the value metered in a circle centered on the current focus point.
- With [**Center-weighted metering**], exposure will be locked at the value metered in a 12-mm circle in the center of the display.

Tip: Adjusting Shutter Speed and Aperture

The following settings can be adjusted while the center of the sub-selector is pressed:

Mode	Setting
P	Shutter speed and aperture (flexible program; 128)
S	Shutter speed
A	Aperture

- The new values can be confirmed in the shooting display and control panel.
-

Exposure Compensation

Exposure compensation is used to alter exposure from the value suggested by the camera. It can be used to make pictures brighter or darker.



-1 EV



No exposure compensation





+1 EV

Adjusting Exposure Compensation

Hold the  button and rotate a command dial.

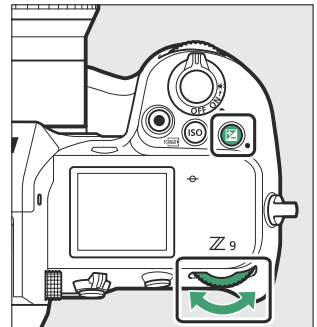
- Choose from values between -5 EV (underexposure) and +5 EV (overexposure). Values between -3 EV and +3 EV are available in video mode.
- At default settings, changes to exposure compensation are made in increments of $\frac{1}{3}$ EV. The size of the increments can be changed using Custom Setting b2 [**EV steps for exposure cntrl**].
- Higher values make the subject brighter, lower values darker.



-  icons and exposure indicators appear in the shooting display and control panel. In modes other than **M**, the zero (“0”) at the center of the exposure indicator flashes. The current value for exposure compensation can be confirmed by pressing the  button.

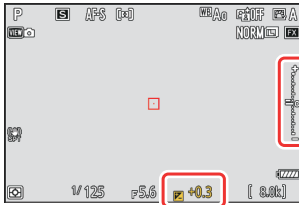

Monitor

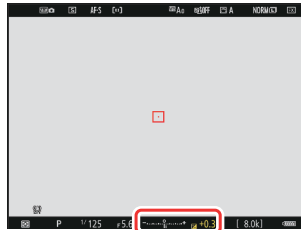

Viewfinder



Control panel

- Normal exposure can be restored by setting exposure compensation to ± 0.0 . Exposure compensation is not reset when the camera is turned off.

Tip: Mode M

- In mode **M**, exposure compensation affects only the exposure indicator; shutter speed and aperture do not change.
- When auto ISO sensitivity control ([book 149](#)) is in effect, ISO sensitivity is automatically adjusted according to the value selected for exposure compensation.

Tip: Using a Flash

When an optional flash is used, exposure compensation affects both flash level and exposure, altering the brightness of both the main subject and the background; if desired, the effect can be restricted to the background using Custom Setting e3 [**Exposure comp. for flash**].







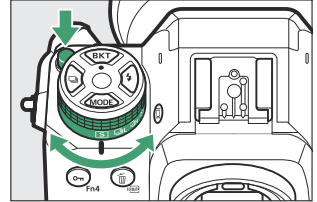

Release Mode

Choosing a Release Mode

To choose the operation performed when the shutter-release button is pressed all the way down, hold the release mode dial lock release and rotate the release mode dial.

- Stop when the pointer aligns with the desired setting.



Mode		Description
	Single frame	The camera takes one photograph each time the shutter-release button is pressed.
	Continuous low-speed	The camera takes photographs at a selected rate while the shutter-release button is pressed. <ul style="list-style-type: none">• Choose from rates of from 10 to 1 fps. To choose the frame rate, hold the  button and rotate a command dial.
	Continuous high-speed	The camera takes photographs at a selected rate while the shutter-release button is pressed. Use for active subjects. <ul style="list-style-type: none">• Choose from rates of from 20 to 10 fps. To choose the frame rate, hold the  button and rotate a command dial.
	Self-timer	Take pictures with the self-timer (book 145).
	Quick release-mode selection	Hold the  button and rotate the main command dial to select the release mode (book 141). <ul style="list-style-type: none">• Quick release-mode selection can be used to choose high-speed frame capture + modes with frame rates of 30, 60, or 120 fps (book 142).

✓ **Frame Advance Rate**

- The frame rates for continuous low-speed and continuous high-speed modes can also be selected using Custom Setting d1 [**Continuous shooting speed**].
- The actual frame rate when a frame advance rate of 8 fps is selected in continuous low-speed mode is 7.5 fps.
- The values given above for frame advance rate assume a focus mode of **AF-C**, shooting mode **M**, a shutter speed of $\frac{1}{250}$ s or faster, and default values for all other settings. Frame advance rates may slow:
 - during flash photography,
 - in silent mode,
 - when flicker is detected with **[ON]** selected for [**Photo flicker reduction**] in the photo shooting menu,
 - if aperture is stopped down to a very high f-number, or
 - at slow shutter speeds.
- When **[ON]** is selected for [**Photo flicker reduction**] in the photo shooting menu ([📖 466](#)), the shooting display will briefly go dark during burst photography.

✓ **Cautions: Burst Photography**

- Depending on shooting conditions and memory card performance, the memory card access lamp may light for anywhere from a few tens of seconds to around a minute. Do not remove the memory card while the memory card access lamp is lit. Not only could any unrecorded pictures be lost, but the camera or memory card could be damaged.
 - At shutter speeds slower than $\frac{1}{250}$ s, the shooting display does not update in real time during burst photography. To track your subject during shooting, choose shutter speeds faster than $\frac{1}{250}$ s.
 - If the camera is switched off while the memory card access lamp is lit, it will not power off until all pictures in the buffer have been recorded.
 - If the battery is exhausted while pictures remain in the buffer, the shutter release will be disabled and the pictures transferred to the memory card.
-

Tip: The Memory Buffer

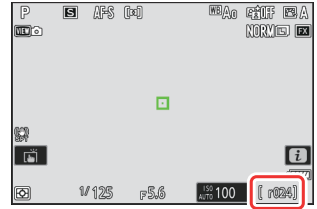

- While the shutter-release button is pressed halfway, the frame-count display will show the number of pictures that can be stored in the memory buffer.
- When the buffer is full, the display will show **r000** and the frame rate will drop.
- The number shown is approximate. The actual number of photos that can be stored in the memory buffer varies with camera settings and shooting conditions.





Tip: Viewing Bursts

Each burst (series) of photos taken in continuous shooting mode or during high-speed frame capture + is treated as a group. To choose how bursts are handled during playback, use the [Series playback] item in the playback menu.

Quick Release-Mode Selection

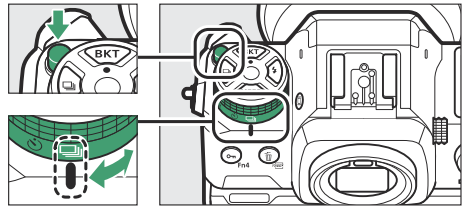

With the release mode dial rotated to , you can choose a release mode by holding the  button and rotating the main command dial.

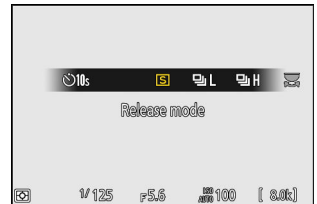

- Settings for the selected mode can be adjusted by holding the  button and rotating the sub-command dial.
- High-speed frame capture + modes with frame rates of 30, 60, or 120 fps are available only when the release mode dial is rotated to  ([142](#)).



High-Speed Frame Capture + (C30/C60/C120)

For high-speed burst photography at frame rates of 30, 60, or 120 fps (high-speed frame capture +), set the release mode dial to  and then hold the  button and rotate the main command dial to choose [C30], [C60], or [C120].

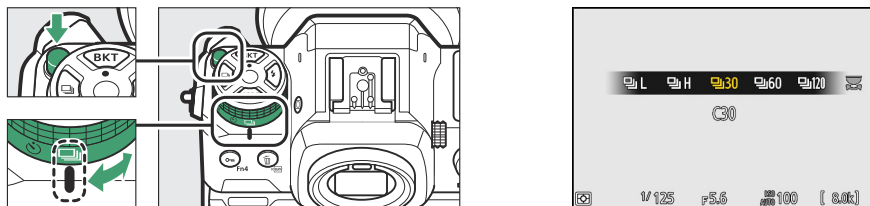

- The maximum length for bursts taken in these modes is approximately four seconds.
- The photos recorded may also include the final pictures from frames buffered while the shutter-release button is pressed halfway ("Pre-Release Capture"); to choose how much of the buffer is saved, use Custom Setting d4 [**Pre-Release Capture options**]. You can also limit the length of the burst recorded after the shutter-release button is pressed all the way down ().
- Photos can be taken at the following settings:

Option	C30	C60	C120
Shutter speed	1/32000 to 1/60 s		1/32000 to 1/125 s
[Image area]	[FX (36×24)] or [DX (24×16)]	[DX (24×16)] only	[FX (36×24)] only
[Image quality]	[JPEG normal] only		
[Image size settings]	[Large] only		[Small] only

- Pictures are recorded in JPEG format.
- The upper limit for ISO sensitivity is ISO 25600, even when higher values (Hi 0.3 through Hi 2.0) are selected.
- The option chosen for **[Minimum shutter speed]** will not apply if **[ON]** is selected for **[ISO sensitivity settings]** > **[Auto ISO sensitivity control]** in the photo shooting menu.
- Exposure compensation is restricted to values between -3 and +3 EV, although settings between -5 and +5 EV can be selected.
- If a DX lens is attached when **[C120]** is selected, the release mode will change to **[C60]** and image area will be fixed at **[DX (24×16)]**.
- The touch shutter can be used only to take one picture at a time. Use the shutter-release button for high-speed frame capture +.

High-Speed Frame Capture +: Restrictions

High-speed frame capture + cannot be combined with some camera features, including:

- flexible program,
 - photo flicker reduction,
 - flash photography,
 - bracketing,
 - multiple exposures,
 - HDR overlay,
 - interval-timer photography,
 - time-lapse video recording, and
 - focus shift.
-

Tip: High-Speed Frame Capture +

Memory cards with a high write speed are recommended ([📖 920](#)).

Using the Self-Timer (☺)

In self-timer mode, pressing the shutter-release button all the way down starts a timer, and a photo is taken when the timer expires.

1 Rotate the release mode dial to ☺ (self-timer mode).

Hold the release mode dial lock release and rotate the release mode dial to ☺.

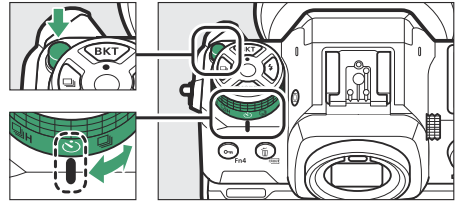

2 Frame the photograph and focus.

The timer will not start if the shutter cannot be released, as may be the case, for example, if the camera is unable to focus when **AF-S** is selected for focus mode.

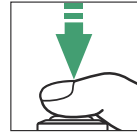

3 Start the timer.

- Press the shutter-release button all the way down to start the timer; the self-timer lamp will begin to flash. The lamp stops flashing two seconds before the timer expires.
- To turn the self-timer off before a photograph is taken, rotate the release mode dial to another setting.

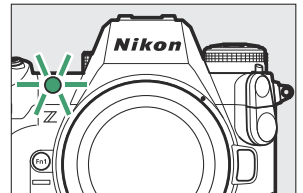
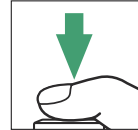

- The timer duration, the number of shots taken, and the interval between shots can be selected using Custom Setting c2 [**Self-timer**].

Tip: Setting the Timer

To choose the timer duration, press and hold the  button and rotate a command dial.

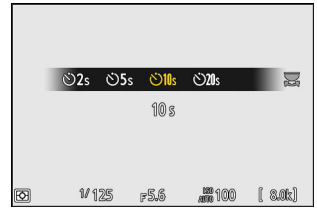

ISO Sensitivity

About ISO Sensitivity

The camera's sensitivity to light (ISO sensitivity) can be adjusted according to the amount of light available. In general, choosing higher values allows faster shutter speeds at the same aperture. Choose from settings of from ISO 64 to 25600. Extended settings of from about 0.3 to 1 EV (ISO 32 equivalent) below ISO 64 and 0.3 to 2 EV (ISO 102400 equivalent) above ISO 25600 are also available.

Adjusting ISO Sensitivity

Hold the **ISO** (ISO) button and rotate the main command dial.

- Your selection is shown in the shooting display and control panel.
- At default settings, changes to ISO sensitivity are made in increments of $\frac{1}{3}$ EV. The size of the increments can be changed using Custom Setting b1 [ISO sensitivity step value].

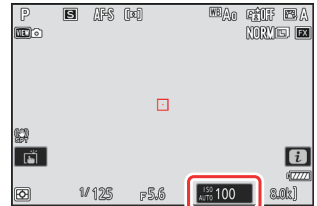

✓ High ISO Sensitivities

The higher the ISO sensitivity, the less light needed to make an exposure, allowing pictures to be taken when lighting is poor and helping prevent blur when the subject is in motion. Note, however, that the higher the sensitivity, the more likely the picture is to be affected by “noise” in the form of randomly-spaced bright pixels, fog, or lines.

- “Noise” can be reduced by enabling high ISO noise reduction. High ISO noise reduction can be enabled using the [High ISO NR] items in the photo shooting and video recording menus.

Tip: The Photo Shooting Menu [ISO Sensitivity Settings] Option

ISO sensitivity can also be adjusted using the **[ISO sensitivity settings]** item in the photo shooting menu.

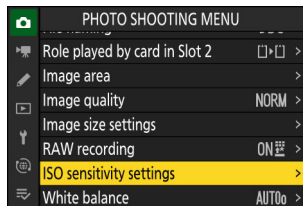
**Tip: Hi 0.3–Hi 2.0**

A setting of **[Hi 0.3]** corresponds to an ISO sensitivity approximately 0.3 EV higher than ISO 25600 (ISO 32000 equivalent) and **[Hi 2.0]** to an ISO sensitivity approximately 2 EV higher (ISO 102400 equivalent). Note that pictures taken at these settings are particularly prone to “noise” in the form of randomly-spaced bright pixels, fog, or lines.

Tip: Lo 0.3–Lo 1.0

[Lo 0.3] corresponds to an ISO sensitivity about 0.3 EV below ISO 64 (ISO 50 equivalent). **[Lo 1.0]** is roughly 1 EV below ISO 64 (ISO 32 equivalent). Use for larger apertures or slower shutter speeds when lighting is bright. Highlights may be overexposed. In most cases, ISO sensitivities of ISO **[64]** or above are recommended.

Auto ISO Sensitivity Control

Auto ISO sensitivity control automatically adjusts ISO sensitivity if optimal exposure cannot be achieved at the value selected by the user. You can select an upper limit for auto ISO sensitivity control (100–Hi 2.0) to prevent ISO sensitivity being raised too high.

Enabling Auto ISO Sensitivity Control

- Hold the **ISO** button and rotate the sub-command dial to select from **ISO AUTO** (auto ISO sensitivity control enabled) and **ISO** (auto ISO sensitivity control disabled).

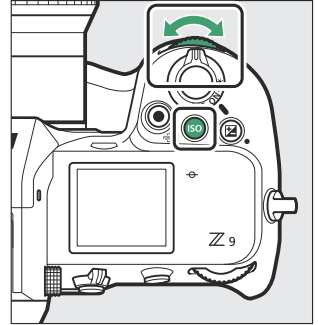

- When auto ISO sensitivity control is enabled, the shooting display will show **ISO AUTO** and control panel **ISO-A**. When sensitivity is altered from the value selected by the user, the ISO sensitivity will be shown in the displays.

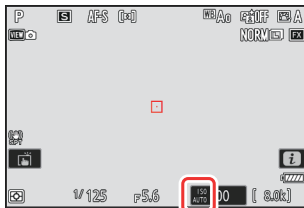

Monitor

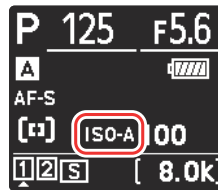

Control panel

- Maximum sensitivity can be adjusted using the **[ISO sensitivity settings]** item in the photo shooting menu.

✓ Cautions: Auto ISO Sensitivity Control

- If the value currently selected for **[ISO sensitivity]** is higher than that chosen for **[Maximum sensitivity]**, the value chosen for **[ISO sensitivity]** will serve as the upper limit for auto ISO sensitivity control.
 - During flash photography, shutter speed is limited to the range defined by the values selected for Custom Settings e1 **[Flash sync speed]** and e2 **[Flash shutter speed]**. If the value selected for **[Minimum shutter speed]** is not in this range, the value selected for Custom Setting e2 **[Flash shutter speed]** becomes the effective minimum shutter speed.
 - Except in mode **M**, videos are recorded using auto ISO sensitivity control. Auto ISO sensitivity control can be enabled for video recording in mode **M** by selecting **[ON]** for **[ISO sensitivity settings]** > **[Auto ISO control (mode M)]** in the video recording menu.
-

White Balance

About White Balance

White balance ensures that colors appear natural regardless of the color of the light source. The default setting (**WB A**) is suitable for use with most light sources, but if it fails to produce the desired results, other settings can be selected according to the weather or light source.















Adjusting White Balance

To choose a white balance option, hold the **WB** button and rotate the main command dial. The selected option is shown by an icon in the shooting display.



Options for the selected setting, if any, can be selected by holding the **WB** button and rotating the sub-command dial.

Option	Color temperature *	Description
WB A [Auto]		The camera adjusts white balance for optimal results with most light sources. If an optional flash unit is used, white balance will be adjusted in accord with the conditions in effect when the flash fires.

Option	Color temperature *	Description
 A₀ [Keep white (reduce warm colors)]	Approx. 3500–8000 K	Eliminate the warm color cast produced by incandescent lighting.
 A₁ [Keep overall atmosphere]	Approx. 3500–8000 K	Partially preserve the warm color cast produced by incandescent lighting.
 A₂ [Keep warm lighting colors]	Approx. 3500–8000 K	Preserve the warm color cast produced by incandescent lighting.
 A [Natural light auto]	Approx. 4500–8000 K	White balance is adjusted for non-artificial light sources, producing more life-like colors than does [Auto] when used under natural light.
 [Direct sunlight]	Approx. 5200K	Use with subjects lit by direct sunlight.
 [Cloudy]	Approx. 6000K	Use in daylight under overcast skies.
 [Shade]	Approx. 8000K	Use in daylight with subjects in shade.
 [Incandescent]	Approx. 3000K	Use under incandescent lighting.
 [Fluorescent]		
 CW [Cool-white fluorescent]	Approx. 4200K	Use under fluorescent lighting; choose bulb type according to light source.
 DW [Day white fluorescent]	Approx. 5000K	
 DY [Daylight fluorescent]	Approx. 6500K	
 [Flash]	Approx. 5400K	Use for flash photography.
 [Choose color temperature]	Approx. 2500–10000K	Direct color-temperature selection. <ul style="list-style-type: none"> To choose a color temperature, hold the WB button and rotate the sub-command dial.

Option	Color temperature *	Description
PRE [Preset manual]		Measure white balance directly from a subject or light source or copy white balance from an existing photograph. <ul style="list-style-type: none"> • To choose a white balance preset, hold the WB button and rotate the sub-command dial. • To enter direct measurement mode, press and hold the WB button (165).

* Values when fine-tuning is set to 0.

☀️A [Natural Light Auto]

☀️A [Natural light auto] may not produce the desired results under artificial light. Choose **WB A [Auto]** or an option that matches the light source.

Studio Flash Lighting

WB A [Auto] may not produce the desired results with large studio flash units. Use preset manual white balance or set white balance to **WB ⚡️ [Flash]** and use fine-tuning to adjust white balance.

Tip: Auto

- The photo info [**Basic shooting data**] page for pictures shot with **WB A [Auto]**, **A [Natural light auto]**, or **PRE [Preset manual]** selected for white balance lists the color temperature in effect at the time the picture was taken (233). You can use this as reference when choosing a value for **W [Choose color temperature]**.
- To view the [**Basic shooting data**] page during playback, go to [**Playback display options**] in the playback menu and place checks () next to [**Shooting data**] and [**Basic shooting data**].
- Color temperature is not shown for pictures taken using high-speed frame capture +.

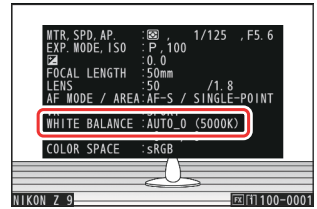

Tip: The [White Balance] Options

White balance can also be adjusted from the photo shooting and video recording menus.



Tip: Color Temperature

The perceived color of a light source varies with the viewer; some may have a red cast while others appear blue. Color temperature is an objective measure of the color of a light source, expressed in Kelvins (K). The lower the color temperature, the redder the cast (①); the higher the temperature, the bluer the cast (②).

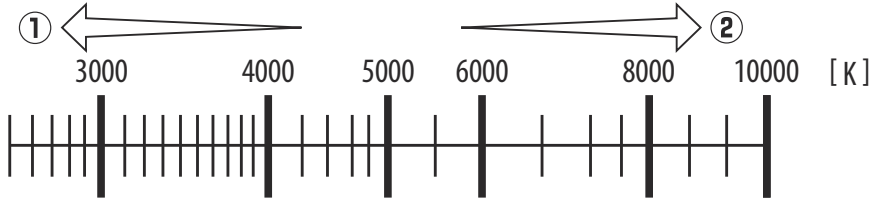

Tip: Choosing a Color Temperature

In general, choose lower values if your pictures have a red cast or to intentionally make pictures bluer, higher values if your pictures are tinged blue or to intentionally make pictures redder.

Fine-Tuning White Balance

Each white balance option can be fine-tuned by up to six steps in either direction from the center along both the A (amber)–B (blue) and G (green)–M (magenta) axes.

Using Buttons

- 1 Choose a white balance option by holding the WB button and rotating a command dial.

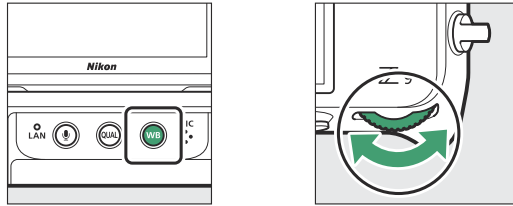

- 2 Keeping the WB button pressed, fine-tune white balance using the multi selector.

- Use the multi selector to position the cursor on the grid. The selected value is displayed to the right of the grid.
- The A (amber)–B (blue) axis corresponds to color temperature and is ruled in increments of 0.5. A change of 1 is equivalent to approximately 5 mired.
- The G (green)–M (magenta) axis has effects similar to color compensation filters and is ruled in increments of 0.25. A change of 1 is equivalent to approximately 0.05 diffuse density units.

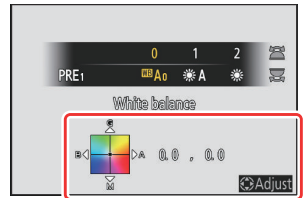

- 3 Save changes.

- The selected setting takes effect when the **WB** button is released.
- If white balance has been fine-tuned, an asterisk ("*") will appear in the white balance icon.

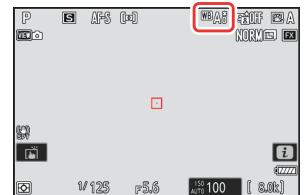

Using the Menus

- 1 Select [White balance] in the photo shooting menu, highlight the desired option, and press \odot as often as necessary to display fine-tuning options.

For information on fine-tuning [Preset manual] white balance, see "Fine-Tuning Preset Manual White Balance" ([link 169](#)).

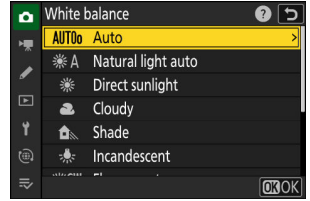

2 Fine-tune white balance.

- Use the multi selector to position the cursor on the grid. The cursor can be moved up to six steps from the center along either of the A (amber)–B (blue) and G (green)–M (magenta) axes. The selected value is displayed to the right of the grid.
- The A (amber)–B (blue) axis corresponds to color temperature and is ruled in increments of 0.5. A change of 1 is equivalent to approximately 5 mired.
- The G (green)–M (magenta) axis has effects similar to color compensation filters and is ruled in increments of 0.25. A change of 1 is equivalent to approximately 0.05 diffuse density units.

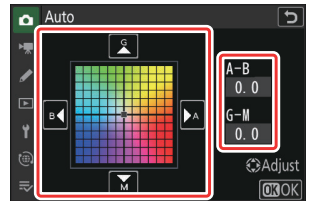

3 Save changes.

- Press \odot to save changes and exit to the menus.
- If white balance has been fine-tuned, an asterisk ("*") will appear in the white balance icon.



Tip: The *i* Menu

Pressing **Ⓢ** when [White balance] is highlighted in the *i* menu displays a list of white balance options. If an option other than **☑** [Choose color temperature] is highlighted, fine-tuning options can be displayed by pressing **Ⓢ**. Any changes to fine-tuning options can be previewed in the display.

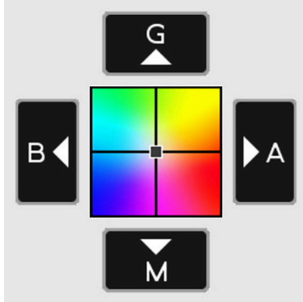
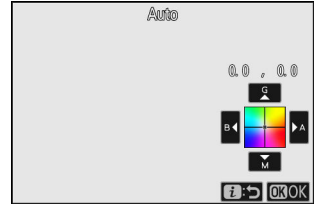

- **G**: Increase green
- **B**: Increase blue
- **A**: Increase amber
- **M**: Increase magenta

- Tap the arrows in the display or use the multi selector to fine-tune white balance.
- Press **Ⓢ** to save changes and return to the *i* menu.
- If white balance has been fine-tuned, an asterisk ("*") will appear in the white balance icon.

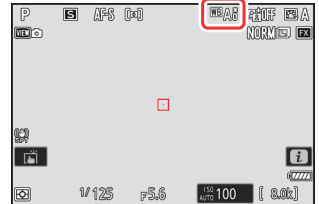

Tip: The Information Display

To choose a white balance setting using the command dials, press the **WB** button while shooting information is displayed. The selected setting can be fine-tuned using the multi selector while the **WB** button is pressed.

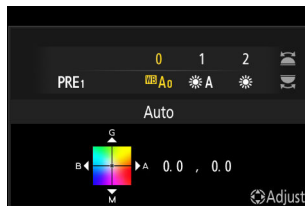

Tip: White Balance Fine-Tuning

The colors on the fine-tuning axes are relative, not absolute. Selecting more of a color on a given axis does not necessarily result in that color appearing in pictures. For example, moving the cursor to B (blue) when a “warm” setting such as  [Incandescent] is selected will make pictures slightly “colder” but will not actually make them blue.

Tip: “Mired”

Values in mired are calculated by multiplying the inverse of the color temperature by 10^6 . Any given change in color temperature produces a greater difference in color at low color temperatures than it would at higher color temperatures. For example, a change of 1000 K produces a much greater change in color at 3000 K than at 6000 K. Mired is a measure of color temperature that takes such variation into account, and as such is the unit used in color-temperature compensation filters.

E.g.: Change in color temperature (in Kelvin) : Value in mired

- 4000 K – 3000 K = 1000 K : 83 mired
 - 7000 K – 6000 K = 1000 K : 24 mired
-

Choosing a Color Temperature

Choose a color temperature by entering values for the A (amber)–B (blue) and G (green)–M (magenta) axes.

Using Buttons

- 1 Hold the WB button and rotate the main command dial to select  [Choose color temperature].

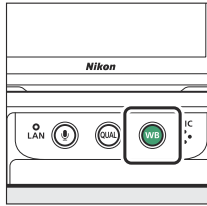

- 2 Keeping the WB button pressed, rotate the sub-command dial to choose a color temperature.

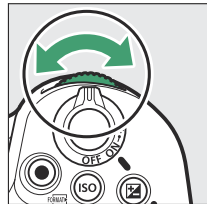
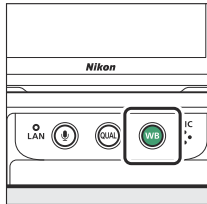

Color temperature will change in increments of 1 mired.

3 Keeping the WB button pressed, fine-tune white balance using the multi selector.

- Use the multi selector to position the cursor on the grid. The selected value is displayed to the right of the grid.
- The A (amber)–B (blue) axis corresponds to color temperature and is ruled in increments of 0.5. A change of 1 is equivalent to approximately 5 mired.
- The G (green)–M (magenta) axis has effects similar to color compensation filters and is ruled in increments of 0.25. A change of 1 is equivalent to approximately 0.05 diffuse density units.

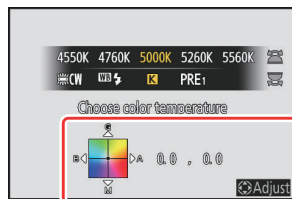

4 Save changes.

- The selected setting takes effect when the **WB** button is released.
- If color temperature has been fine-tuned, an asterisk ("*") will appear in the white balance icon.

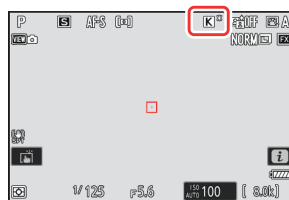

Using the Menu

1 Select [White balance] in the photo shooting menu, then highlight **[Choose color temperature]** and press **[OK]**.

2 Choose a color temperature.

Press **[Left]** or **[Right]** to highlight digits and press **[Up]** or **[Down]** to change.

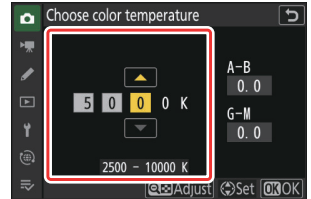

3 Fine-tune white balance.

After choosing a color temperature, press the **[Help]** (?) button to display fine-tuning options. Use the multi selector to position the cursor on the grid.

- The cursor can be moved up to six steps from the center along either axis. The selected value is displayed to the right of the grid.
- The A (amber)–B (blue) axis corresponds to color temperature and is ruled in increments of 0.5. A change of 1 is equivalent to approximately 5 mired.
- The G (green)–M (magenta) axis has effects similar to color compensation filters and is ruled in increments of 0.25. A change of 1 is equivalent to approximately 0.05 diffuse density units.

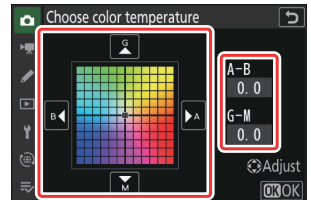

4 Save changes.

- Press **OK** to save changes and exit to the menus.
- If color temperature has been fine-tuned, an asterisk (“*”) will appear in the white balance icon.

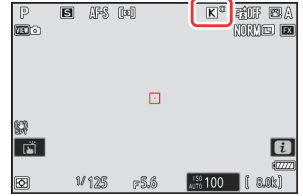

✓ Cautions: Color-Temperature Selection

- Do not use color-temperature selection with fluorescent light sources; instead, use the **Fluorescent** option.
- When using color-temperature selection with other light sources, take a test shot to determine if the selected value is appropriate.

Tip: The *i* Menu

Pressing **OK** when **[White balance]** is highlighted in the *i* menu displays a list of white balance options. When **K [Choose color temperature]** is highlighted, color temperature options can be viewed by pressing **OK**.

- Press **Left** or **Right** to highlight digits and press **Up** or **Down** to change.
- To fine-tune the currently-selected value, press the **Q/?** button.
- Press **OK** to save changes and return to the *i* menu.
- If color temperature has been fine-tuned, an asterisk (“*”) will appear in the white balance icon.

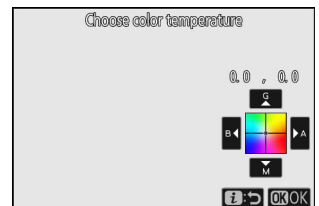
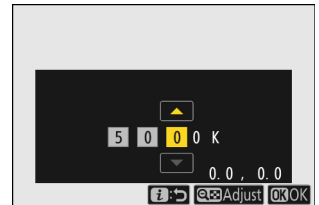

Preset Manual

White balance settings such as **WB A [Auto]**, **[Incandescent]**, and **[K [Choose color temperature]]** may fail to produce the desired results under mixed lighting or lighting with a strong color cast. Should this occur, white balance can be set to a value measured under the light source used in the final photograph. Two methods are available for setting preset white balance:

Method	Description
Direct measurement	Measure white balance in a selected area of the frame (165).
Copying a value from existing photograph	Copy white balance from a photo on a memory card (168).

✓ White Balance Presets

Changes to white balance presets d-1 through d-6 apply to all shooting menu banks (A–D). For example, changes to presets made when shooting menu bank A is selected also apply to shooting menu banks B through D.

Direct Measurement

The camera can store up to six values for preset manual white balance.

1 Hold the WB button and rotate the main command dial to select PRE.

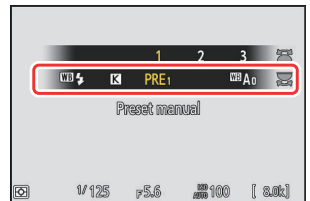
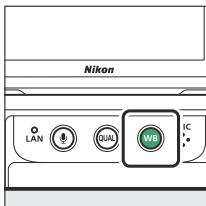

2 Select a preset.

Hold the **WB** button and rotate the sub-command dial until the desired white balance preset (d-1 to d-6) is displayed.

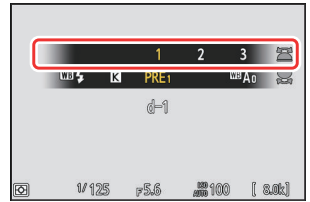
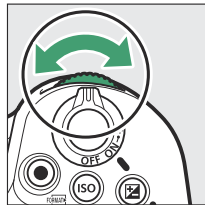
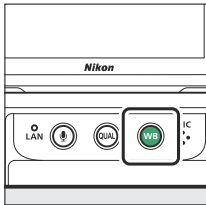

3 Select direct measurement mode.

- Release the **WB** button briefly and then press the **WB** button until the **PRE** icon in the monitor starts to flash.
- A white balance target (□) will appear in the center of the frame.

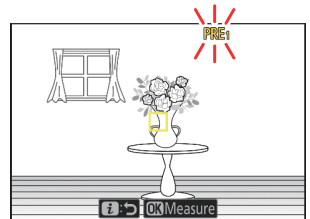

4 Position the white balance target (□) over a white or gray object and measure a value for preset manual white balance.

- Position the target (□) using the multi selector.
- To measure white balance, press the shutter-release button all the way down or press **Ⓜ**.
- You can also position the target (□) and measure white balance by tapping the display.
- Target selection will not be available if an optional flash unit is attached. Frame the shot so that the white or gray reference object is in the center of the display.
- If the camera is unable to measure white balance, a message will be displayed and the camera will return to direct measurement mode. Try measuring white balance again, for example with the target (□) positioned over a different area of the subject.

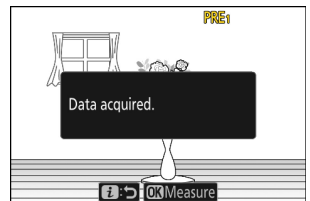

5 Press the **i** button to exit direct measurement mode.

✓ The Preset Manual White Balance Menu

The preset manual white balance menu can be accessed by selecting **[White balance]** > **PRE [Preset manual]** in the photo shooting menu. The preset manual white balance menu offers options for copying values for preset manual white balance from an existing photograph or adding comments to or protecting white balance presets.

✓ Protected Presets

White balance presets indicated by **On** icons are protected and cannot be changed.

✓ Preset Manual: Selecting a Preset

- At shipment, presets d-1 through d-6 are set to 5200 K, equivalent to the **☀ [Direct sunlight]** white balance option.
- White balance presets can be viewed by selecting **[White balance]** > **PRE [Preset manual]** in the photo shooting menu. To recall a stored value, highlight a preset using the multi-selector and press **⊗**.

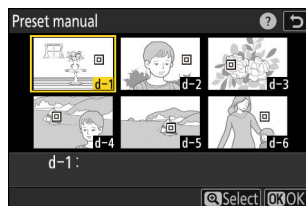

✓ Direct Measurement Mode

Direct measurement mode will end if no operations are performed in the time selected for Custom Setting c3 **[Power off delay]** > **[Standby timer]**.

✓ Measuring White Balance

Preset manual white balance cannot be measured during high-speed frame capture + or multiple exposures.

Copying White Balance from a Photograph

Follow the steps below to copy a value for white balance from an existing photograph to a selected preset.

- 1 Select **[White balance]** in the photo shooting menu, then highlight **[Preset manual]** and press **OK**.

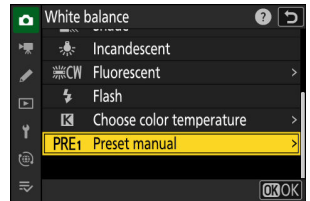

- 2 Select a destination.

- Using the multi selector, highlight the destination preset (d-1 to d-6).
- Press **Q** to view the preset manual white balance menu.

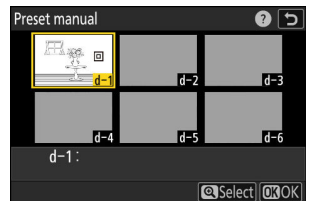

- 3 Choose **[Select picture]**.

Highlight **[Select picture]** and press **Q** to view the pictures on the current memory card.

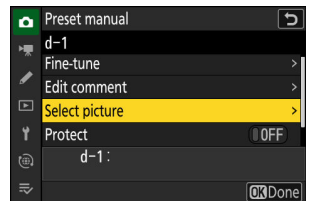

- 4 Highlight the source picture.

- Highlight the desired picture using the multi selector.
- To view the highlighted picture full frame, press and hold the **Q** button.

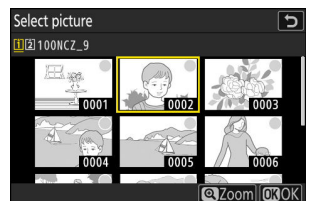

5 Copy white balance.

- Press **Ⓜ** to copy the white balance value for the highlighted photograph to the selected preset.
- If the highlighted photograph has a comment, the comment will be copied to the comment for the selected preset.

Tip: Fine-Tuning Preset Manual White Balance

The selected preset can be fine-tuned by selecting **[Fine-tune]** in the preset manual white balance menu.

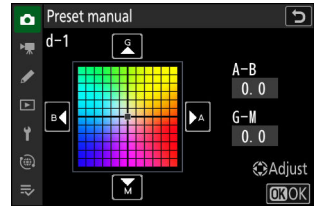

Tip: "Edit Comment"

To enter a descriptive comment of up to 36 characters for the current white balance preset, select **[Edit comment]** in the preset manual white balance menu. Enter a comment as described in "Text Entry" ([71](#)).



Tip: "Protect"

To protect the current white balance preset, select **[ON]** for **[Protect]** in the preset manual white balance menu. The preset cannot be modified as long as **[ON]** is selected for **[Protect]**.

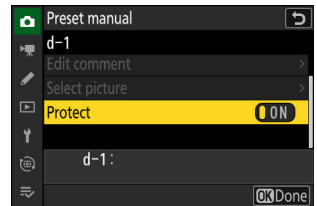

Bracketing

Bracketing automatically varies exposure, flash level, Active D-Lighting (ADL), or white balance slightly with each shot, “bracketing” the current value. Bracketing can be used in situations in which getting the right settings is difficult and there is not time to check results and adjust settings with each shot, or to experiment with different settings for the same subject.

Auto Bracketing Set

Bracketing is adjusted using the **[Auto bracketing]** > **[Auto bracketing set]** item in the photo shooting menu, which contains the following options:

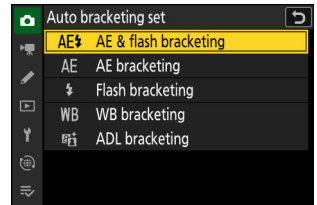

Option	Description
[AE & flash bracketing]	The camera varies exposure and flash level over a series of photographs.
[AE bracketing]	The camera varies exposure over a series of photographs.
[Flash bracketing]	The camera varies flash level over a series of photographs.
[WB bracketing]	The camera creates multiple copies of each photograph, each with a different white balance.
[ADL bracketing]	The camera varies Active D-Lighting (ADL) over a series of exposures.

Exposure and Flash Bracketing

Vary exposure and/or flash level over a series of photographs. To perform exposure and/or flash bracketing:



No exposure compensation



-1 EV



+1 EV

7 Choose the number of shots.

- Hold the **BKT** button and rotate the main command dial to choose the number of shots in the bracketing sequence.

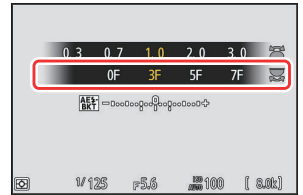
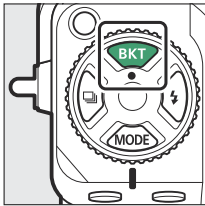

- At settings other than **[0F]**, a bracketing icon and indicator will appear in the shooting display and control panel.

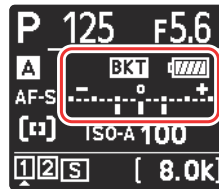
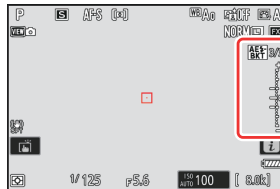

2 Select an exposure increment.

- Hold the **BKT** button and rotate the sub-command dial to choose the exposure increment.

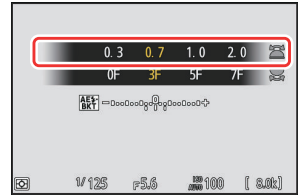
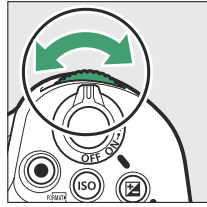
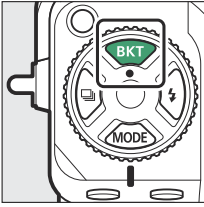

- When **[1/3 step]** is selected for Custom Setting b2 **[EV steps for exposure ctrl]**, the size of the increment can be chosen from 0.3 ($1/3$), 0.7 ($2/3$), 1.0, 2.0, and 3.0 EV. Bracketing programs with an increment of 2.0 or 3.0 EV offer a maximum of 5 shots. If a value of 7 or 9 was selected in Step 1, the number of shots will automatically be set to 5.
- The bracketing programs with an increment of 0.3 EV are listed below.

Control panel		Exposure and flash bracketing indicator	No. of shots	Bracketing order
0F	0.3	— · · · · · 0 · · · · · +	0	0
3F	0.3	— · · · · · 0 · · · · · +	3	0/-0.3/+0.3
5F	0.3	— · · · · · 0 · · · · · +	5	0/-0.7/-0.3/+0.3/+0.7
7F	0.3	— · · · · · 0 · · · · · +	7	0/-1.0/-0.7/-0.3/ +0.3/+0.7/+1.0
9F	0.3	— · · · · · 0 · · · · · +	9	0/-1.3/-1.0/-0.7/-0.3/ +0.3/ +0.7/ +1.0/ +1.3

3 Take pictures.

- Take the number of pictures in the bracketing program.
 - The modified values for shutter speed and aperture are shown in the display.
- While bracketing is in effect, the shooting display shows a bracketing icon, a bracketing progress indicator, and the number of shots remaining in the bracketing sequence. After each shot, a segment will disappear from the indicator and the number of shots remaining will be reduced by one.

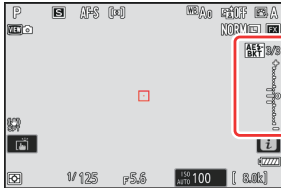
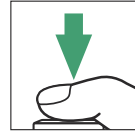

No. shots: 3
Increment: 0.7

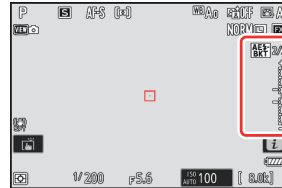

Display after first shot

- The control panel shows a **BKT** icon and a bracketing progress indicator. A segment disappears from the indicator after each shot.

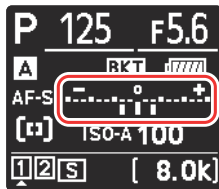

No. shots: 3
Increment: 0.7

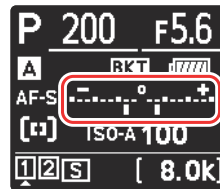

Display after first shot

- Exposure changes due to bracketing are added to those made with exposure compensation.

Tip: Bracketing Options

When **[AE & flash bracketing]** is selected, the camera varies both exposure and flash level. Select **[AE bracketing]** to vary only exposure, **[Flash bracketing]** to vary only flash level. Note that flash bracketing is available in i-TTL and, where supported, auto aperture (Ⓐ) flash control modes only (📖 406, 📖 846).

Tip: Exposure and Flash Bracketing

- **[Number of shots]** and **[Increment]** can also be selected via the **[Auto bracketing]** item in the photo shooting menu.
- In continuous release modes, shooting will pause after the number of shots specified in the bracketing program have been taken. Shooting will resume the next time the shutter-release button is pressed.
- If the camera is turned off before all shots in the sequence have been taken, bracketing will resume from the first shot in the sequence when the camera is turned on.

Tip: Exposure Bracketing

The settings (shutter speed and/or aperture) altered during exposure bracketing vary with the shooting mode.

Mode	Setting
P	Shutter speed and aperture ¹
S	Aperture ¹
A	Shutter speed ¹
M	Shutter speed ^{2, 3}

- 1 If **[ON]** is selected for **[ISO sensitivity settings]** > **[Auto ISO sensitivity control]** in the photo shooting menu, the camera will automatically vary ISO sensitivity for optimum exposure when the limits of the camera exposure system are exceeded.
 - 2 If **[ON]** is selected for **[ISO sensitivity settings]** > **[Auto ISO sensitivity control]** in the photo shooting menu, the camera will vary ISO sensitivity.
 - 3 Use Custom Setting e6 **[Auto bracketing (mode M)]** to choose whether the camera varies both shutter speed and aperture or any one of shutter speed, aperture, and ISO sensitivity when **[OFF]** is selected for **[ISO sensitivity settings]** > **[Auto ISO sensitivity control]** in the photo shooting menu.
-

■ Cancelling Bracketing

To cancel bracketing, press the **BKT** button and rotate the main command dial until the number of shots in the bracketing sequence is zero (**0F**). The program last in effect will be restored the next time bracketing is activated. Bracketing can also be cancelled by performing a two-button reset ([📖 197](#)), although in this case the bracketing program will not be restored the next time bracketing is activated.

White Balance Bracketing

The camera creates multiple copies of each photograph, each with a different white balance. To use white balance bracketing:

1 Choose the number of shots.

- Hold the **BKT** button and rotate the main command dial to choose the number of shots in the bracketing sequence.

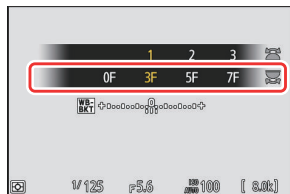
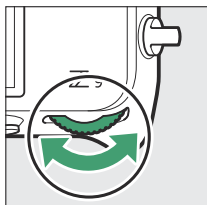
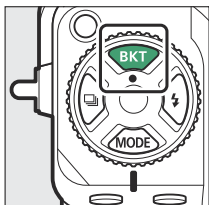

- At settings other than [0F], a bracketing icon and indicator will appear in the shooting display and control panel.

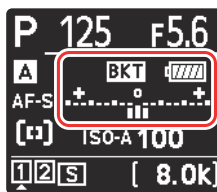
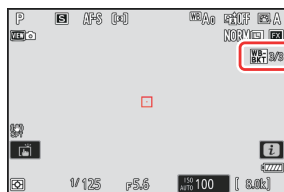

2 Select a white balance increment.

- Hold the **BKT** button and rotate the sub-command dial to choose the white balance increment.

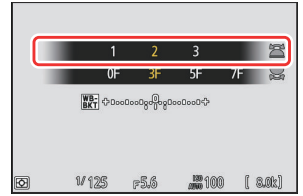
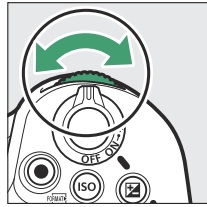
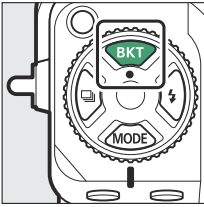

- The size of the increment can be chosen from 1 (1 step), 2 (2 steps), or 3 (3 steps).
- Each step is equivalent to 5 mired. Higher "A" values correspond to increased amounts of amber. Higher "B" values correspond to increased amounts of blue.
- The bracketing programs with an increment of 1 are listed below.

Control panel		White balance bracketing indicator	No. of shots	White balance increment	Bracketing order
0F	1	+.....0.....+	0	1	0
3F	1	+.....0.....+	3	1A, 1B	0/A1/B1
5F	1	+.....0.....+	5	1A, 1B	0/A2/A1/B1/B2
7F	1	+.....0.....+	7	1A, 1B	0/A3/A2/A1/B1/B2/B3
9F	1	+.....0.....+	9	1A, 1B	0/A4/A3/A2/A1/B1/B2/B3/B4

3 Take pictures.

- Each shot will be processed to create the number of copies specified in the bracketing program, and each copy will have a different white balance.
- Modifications to white balance are added to the white balance adjustment made with white balance fine-tuning.
- If the number of shots in the bracketing program is greater than the number of exposures remaining, the shutter release will be disabled. Shooting can begin when a new memory card is inserted.

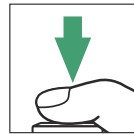

✓ White Balance Bracketing Restrictions

White balance bracketing is not available at image quality settings of NEF (RAW) or NEF (RAW) + JPEG.

Tip: White Balance Bracketing

- **[Number of shots]** and **[Increment]** can also be selected via the **[Auto bracketing]** item in the photo shooting menu.
 - White balance bracketing affects only color temperature (the amber–blue axis in the white balance fine-tuning display). No adjustments are made on the green–magenta axis.
 - If the camera is turned off while the memory card access lamp is lit, the camera will power off only after all photographs in the sequence have been recorded.
 - In self-timer mode, the number of copies specified in the white balance bracketing program will be created each time the shutter is released, regardless of the option selected for Custom Setting c2 **[Self-timer]** > **[Number of shots]**.
-

■ Cancelling Bracketing

To cancel bracketing, press the **BKT** button and rotate the main command dial until the number of shots in the bracketing sequence is zero (**0F**). The program last in effect will be restored the next time bracketing is activated. Bracketing can also be cancelled by performing a two-button reset ([📖 197](#)), although in this case the bracketing program will not be restored the next time bracketing is activated.

ADL Bracketing

The camera varies Active D-Lighting (ADL) over a series of exposures. To use ADL bracketing:

1 Choose the number of shots.

- Hold the **BKT** button and rotate the main command dial to choose the number of shots in the bracketing sequence.

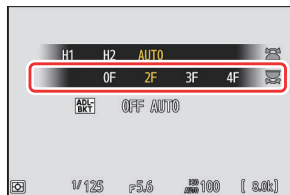
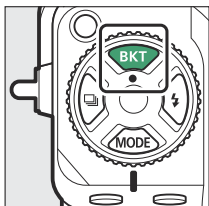

- At settings other than **[0F]**, a bracketing icon and indicator will appear in the shooting display and control panel.

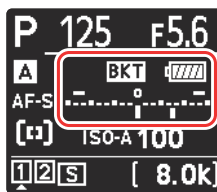
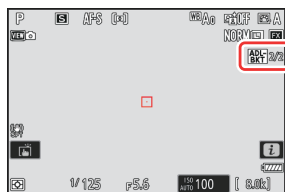

- The number of shots determines the bracketing sequence:

No. of shots		Bracketing sequence
2		Off → Value selected in Step 2
3		Off → Low → Normal
4		Off → Low → Normal → High
5	[H1]	Off → Low → Normal → High → Extra high 1
	[H2]	Low → Normal → High → Extra high 1 → Extra high 2

- If you selected 5 shots, you can choose from bracketing sequences [H1] and [H2] by holding the **BKT** button and rotating the sub-command dial.
- If you chose more than two shots, proceed to Step 3.

2 Choose the Active D-Lighting amount.

- Hold the **BKT** button and rotate the sub-command dial to choose the Active D-Lighting setting for the second shot when the number of shots in the bracketing sequence is 2.

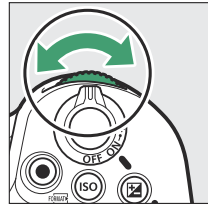
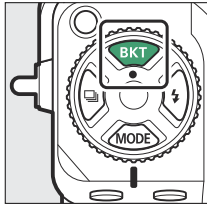

- The bracketing sequence varies with the Active D-Lighting amount as follows:

Amount	Bracketing sequence
[L]	Off → Low
[N]	Off → Normal
[H]	Off → High
[H1]	Off → Extra high 1
[H2]	Off → Extra high 2
[AUTO]	Off → Auto

3 Take pictures.

- Take the number of pictures in the bracketing program.
- While bracketing is in effect, the shooting display shows an ADL bracketing icon and the number of shots remaining in the bracketing sequence. After each shot, the number of shots remaining will be reduced by one.
- The control panel shows a **BKT** icon and a bracketing progress indicator. A segment disappears from the indicator after each shot.

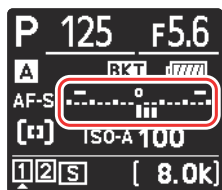
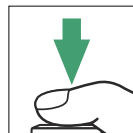

No. shots: 3

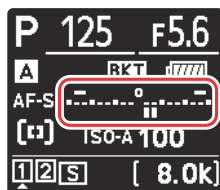

Display after first shot

✓ ADL Bracketing

- [Number of shots] and [Amount] can also be selected via the [Auto bracketing] item in the photo shooting menu.
- In continuous release modes, shooting will pause after the number of shots specified in the bracketing program have been taken. Shooting will resume the next time the shutter-release button is pressed.
- If the camera is turned off before all shots in the sequence have been taken, bracketing will resume from the first shot in the sequence when the camera is turned on.

Cancelling Bracketing

To cancel bracketing, press the **BKT** button and rotate the main command dial until the number of shots in the bracketing sequence is zero (**0F**). The program last in effect will be restored the next time bracketing is activated. Bracketing can also be cancelled by performing a two-button reset ([197](#)), although in this case the bracketing program will not be restored the next time bracketing is activated.

Picture Controls

About Picture Controls





Choose image processing (“Picture Control”) options for new photos according to the scene or your creative intent.

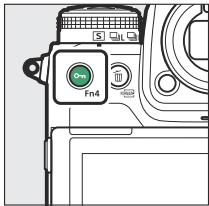



Choosing a Picture Control

At default settings, Picture Controls can be selected by holding the **Fn** (Fn4) button and rotating the main command dial. The selected option is shown by an icon in the shooting display.



- When a Creative Picture Control is selected, the effect level can be chosen by holding the **Fn** (Fn4) button and rotating the sub-command dial.
- The Picture Control for videos can be selected by pressing the **Fn** (Fn4) button in video mode.

Option	Description
 [Auto]	The camera automatically adjusts hues and tones based on the [Standard] (photo mode) or [Neutral] (video mode) Picture Control.
 [Standard]	Standard processing for balanced results. Recommended for most situations.
 [Neutral]	Minimal processing for natural results. Choose for photographs that will later be processed or retouched.
 [Vivid]	Pictures are enhanced for a vivid, photoprint effect. Choose for photographs that emphasize primary colors.
 [Monochrome]	Take monochrome photographs.

Option		Description
 PT	[Portrait]	Smooth complexions for natural-looking portraits.
 LS	[Landscape]	Shoot vibrant landscapes and cityscapes.
 FL	[Flat]	Details are preserved over a wide tone range, from highlights to shadows. Choose for photographs that will later be extensively processed or retouched.
 01– 20	Creative Picture Control	Creative Picture Controls offer unique combinations of hue, tone, saturation, and other settings tuned for particular effects. Choose from a total of 20 options, including [Dream] and [Morning] .

✓ “Set Picture Control”

- Picture Controls can also be selected using the **[Set Picture Control]** items in the photo shooting and video recording menus.
- The **[Set Picture Control]** item in the video recording menu also offers a **[Same as photo settings]** option that sets the Picture Control for videos to the same as that used for photographs.

Modifying Picture Controls

Picture Controls can be adapted to suit the scene or the photographer's creative intent.

1 Select a Picture Control.

Select **[Set Picture Control]** in the photo shooting or video recording menu and then highlight the desired Picture Control and press **[OK]**.

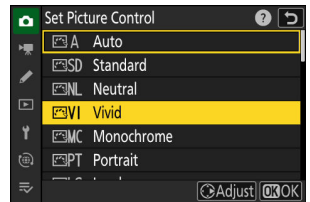

2 Adjust settings.

- Press **[Left]** or **[Right]** to highlight settings. Press **[Up]** or **[Down]** to choose a value in increments of 1, or rotate the sub-command dial to choose a value in increments of 0.25.
- The options available vary with the Picture Control selected.
- To quickly adjust levels for balanced **[Sharpening]**, **[Mid-range sharpening]**, and **[Clarity]**, highlight **[Quick sharp]** and press **[Left]** or **[Right]**.
- To abandon any changes and start over from default settings, press the **[Reset]** button.



3 Save changes and exit.

Press **[OK]** to save changes. Picture Controls that have been modified from default settings are indicated by an asterisk ("*****").



Picture Control Settings

Option	Description
[Effect level]	Mute or heighten the effect of Creative Picture Controls.
[Quick sharp]	Use [Quick sharp] to quickly adjust levels for balanced [Sharpening], [Mid-range sharpening], and [Clarity]. These parameters can also be adjusted individually.
[Sharpening]	Control the sharpness of details and outlines.
[Mid-range sharpening]	Adjust the sharpness of patterns and lines in the range between [Sharpening] and [Clarity].
[Clarity]	Adjust overall sharpness and the sharpness of thicker outlines without affecting brightness or dynamic range.
[Contrast]	Adjust contrast.
[Brightness]	Raise or lower brightness without loss of detail in highlights or shadows.
[Saturation]	Control the vividness of colors.
[Hue]	Adjust hue.
[Filter effects]	Simulate the effect of color filters on monochrome pictures.
[Toning]	Choose the tint used in monochrome pictures. Pressing  when an option other than [B&W] (black-and-white) is selected displays saturation options.
[Toning] (Creative Picture Controls)	Choose the shade of color used for Creative Picture Controls.

✓ The Δ Indicator

The Δ indicator under the value display in the Picture Control setting menu indicates the previous value for the setting.



✓ [A] (Auto)

- Selecting the **A** (auto) option available for some settings lets the camera adjust the setting automatically.
- Results vary with exposure and the position of the subject in the frame.

✓ [Filter Effects]

Choose from the following [**Filter effects**]:

Option	Description
[Y] (yellow) *	These options enhance contrast and can be used to tone down the brightness of the sky in landscape photographs. Orange [O] produces more contrast than yellow [Y], red [R] more contrast than orange.
[O] (orange) *	
[R] (red) *	
[G] (green) *	Green softens skin tones. Use for portraits and the like.

* The term in parentheses is the name of the corresponding third-party color filter for black-and-white photography.

✓ The "Auto" Picture Control

Settings can be adjusted in the range [A-2] to [A+2].



Tip: The *i* Menu

Highlighting [**Set Picture Control**] in the *i* menu and pressing **OK** displays a Picture Control list. Highlight a Picture Control and press **OK** to edit settings while previewing the effect in the display.

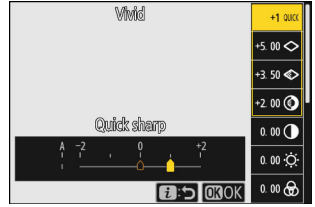

- Press **Left Arrow** or **Right Arrow** to highlight settings. Press **Up Arrow** or **Down Arrow** to choose a value in increments of 1, or rotate the sub-command dial to choose a value in increments of 0.25.
- The options available vary with the Picture Control selected.
- To abandon any changes and start over from default settings, press the **Reset** button.
- Press **OK** to save changes.

- Picture Controls that have been modified from default settings are indicated by an asterisk ("*****").

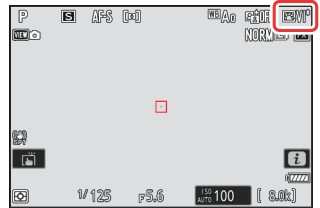

Custom Picture Controls

Save modified Picture Controls as custom Picture Controls.

Option	Description
[Save/edit]	Create a new custom Picture Control based on an existing preset or custom Picture Control, or edit existing custom Picture Controls.
[Rename]	Rename custom Picture Controls.
[Delete]	Delete custom Picture Controls.
[Load/save]	Copy custom Picture Controls to and from a memory card.

Creating Custom Picture Controls

- 1 Highlight [Manage Picture Control] in the photo shooting or video recording menu and press .

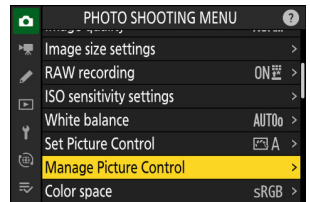

- 2 Select [Save/edit].

Highlight [Save/edit] and press  to view [Choose Picture Control] options.

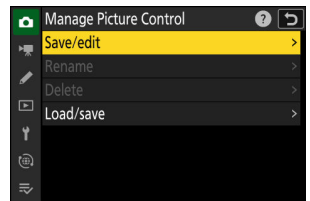

3 Select a Picture Control.

- Highlight an existing Picture Control and press **▶** to display edit options.
- To save a copy of the highlighted Picture Control without further modification, press **Ⓜ**. **[Save as]** options will be displayed; proceed to Step 5.

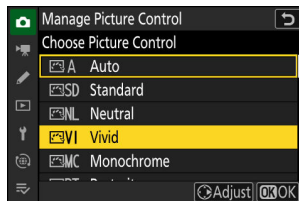

4 Adjust settings.

- The options and procedure are the same as for **[Set Picture Control]**.
- Press **Ⓜ** to display **[Save as]** options when settings are complete.
- To abandon any changes and start over from default settings, press the **🗑️ (Reset)** button.



5 Select a destination.

Choose a destination for the custom Picture Control (C-1 through C-9).

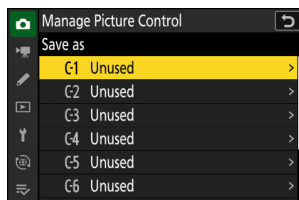

6 Name the Picture Control.

- Pressing  when a destination is highlighted in the previous step displays the **[Rename]** text-entry dialog.
- The default name, created by adding a two-digit number to the name of the existing Picture Control, appears in the text display area. The two-digit number is generated automatically by the camera.
- Custom Picture Control names can be up to nineteen characters long.
- For information on text entry, see “Text Entry” ([71](#)).



7 Press the button.

- Text entry will end.

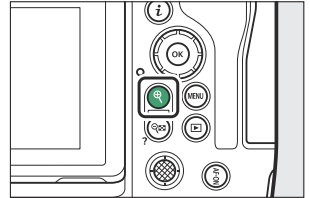

- The new Picture Control will be added to the Picture Control list.



✓ The Original Picture Control Icon

The original preset Picture Control on which the custom Picture Control is based is indicated by an icon in the edit display.



✓ Custom Picture Control Options

The options available with custom Picture Controls are the same as those on which the custom Picture Control was based.

✓ Sharing Custom Picture Controls

The **[Load/save]** item in the **[Manage Picture Control]** menu can be used to copy custom Picture Controls from the camera to a memory card. You can also delete custom Picture Controls or copy them from a memory card to the camera (the memory card must be inserted in Slot 1, as memory cards inserted in Slot 2 will not be detected).

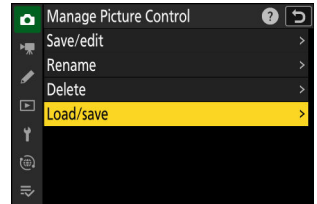

- **[Copy to camera]:** Copy (import) custom Picture Controls from the memory card to the camera. The Picture Controls are copied to custom Picture Controls C-1 through C-9 on the camera and can be named as desired.
 - **[Delete from card]:** Delete selected custom Picture Controls from the memory card.
 - **[Copy to card]:** Copy (export) a custom Picture Control from the camera to a memory card. Highlight a destination (1 through 99) for the selected Picture Control and press **[OK]** to export it to the memory card.
-

Location Data

The built-in location data unit records the camera's current latitude, longitude, and altitude, together with the current time (Coordinated Universal Time, or UTC). Location data embedded in pictures can be viewed in the location data page of the playback photo info display ([📖 236](#)).

Location Data Options

To enable or disable the location data function or adjust location data settings, highlight **[Location data (built-in)]** in the setup menu and press **⏏**.

Option	Description
[Record location data]	Select [ON] to enable the location data function.
[Standby timer]	If [ON] is selected when [Record location data] is set to [ON] , the standby timer will expire if no operations are performed for the period chosen using Custom Setting c3 [Power off delay] > [Standby timer] . Choose this option to reduce the drain on the battery.
[Set clock from satellite]	Select [ON] to synchronize the camera clock with the time reported by the location data function.
[Create log]	Record a track log. <ul style="list-style-type: none">• [Log location data]: The camera will log location data at the interval chosen using [Log interval] for the time selected for [Log length]. To end, pause, or resume the log, highlight [Create log] and press ⏏.• [Log interval]: Choose how often the camera logs its current location.• [Log length]: Choose how long logging will continue.
[Log list]	List track logs by date. <ul style="list-style-type: none">• Where multiple logs were recorded on the same day, an identifier appears after the date.• The camera can store up to 100 track logs.• To delete a log, highlight it and press 🗑️ (DELETE).

Option	Description
[Position]	View the latitude, longitude, altitude, and Coordinated Universal Time (UTC) currently reported by the built-in location data unit. UTC data are provided by the built-in location data unit independently of the camera clock.

The Satellite Signal Indicator

Signal strength is shown by a 📶 icon in the shooting display.

- 📶 **(static)**: The camera records the current latitude, longitude, and altitude.
- 📶 **(flashing)**: The camera is unable to determine its location from the satellite signal; location data are not recorded. Wait for the 📶 icon to stop flashing.

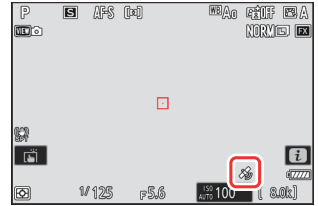

✓ Cautions: Location Data

- Turning the camera off does not disable the location data function. The location data function can be disabled by selecting **[OFF]** for **[Location data (built-in)]** > **[Record location data]** in the setup menu.
- The location data recorded with videos are those reported at the start of recording.
- The camera may in certain cases need additional time to acquire location data, for example immediately after the battery is inserted, when the location data function is enabled for the first time, or after an extended period of disuse.
- The positions of navigation satellites change constantly. This may slow or prevent the acquisition of location data in some locations or at certain hours of the day.
- Satellite signals may be blocked or reflected in the locations listed below, rendering the data acquired less accurate or preventing its acquisition altogether.
 - In buildings or under ground
 - Between tall buildings
 - Under bridges
 - In tunnels
 - Near power lines or similar structures
 - In dense forest
 - In metal briefcases or other containers
- The presence of cellular telephones or other devices that produce strong electromagnetic fields or transmit on frequencies close to those of navigation satellites may interfere with the acquisition of location data.
- Where the error in the signal from the satellite is very large, the location reported by the camera may differ from its actual location by up to several hundred meters.
- Due to variability in the precision of the location data acquired, differences between geodetic systems, and other factors, the location data embedded in pictures may differ from the location in which they were actually recorded.

✔ **Cautions: Track Logs**

- Track logs will not be recorded if the camera clock is not set or if no memory card is inserted.
- To prevent logs being interrupted, be sure the camera battery is fully charged.
- Tracking ends if:
 - the camera battery runs low,
 - the battery is removed, or
 - **[OFF]** is selected for **[Location data (built-in)]** > **[Record location data]**.
- Location data will not be logged while the camera is unable to acquire a satellite signal.

✔ **Track Logs**

- The time remaining appears in the **[Location data (built-in)]** display while logging is in progress.
 - Logs are not interrupted when the camera is turned off or the standby timer expires. Be sure to monitor the battery level while logging is in progress.
 - Logs are stored in the "NIKON" > "GNSS" folder on the memory card and have names of the form "Nyymmddx.log". Here "yy" is the last two digits of the current year, "mm" the month, "dd" the day, "x" a single-character identifier from 0 (zero) to Z assigned in ascending order by the camera, and ".log" the extension (thus the first log recorded on October 15, 2021, will be named "N2110150.log").
 - Logs are in NMEA format. There is however no guarantee that they will display correctly in all software or on all devices.
-

Tip: SnapBridge

- You can also use the SnapBridge app to download location data to the camera from a smartphone or tablet (smart device) via a wireless link even when location data cannot be acquired using the camera's built-in location data unit. See SnapBridge online help for details.
 - Location data downloaded from the smart device will be recorded with pictures even if **[OFF]** is selected for **[Location data (built-in)]** > **[Record location data]**. Location data recording can be ended by disabling the location data feature in the SnapBridge app.
-

Two-Button Reset

The camera settings listed below can be restored to default values by pressing the two buttons marked with green ● dots (**BKT** and **⌘**) at the same time and holding them for over two seconds (the shooting display and control panel turn off briefly while settings are reset).

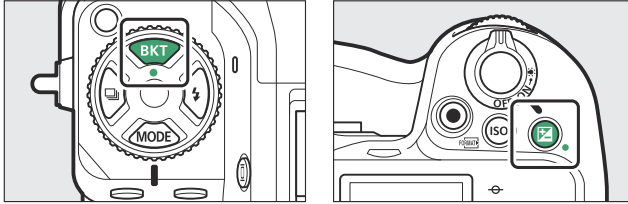



Photo Shooting Menu

With the exceptions of multiple exposure, interval timer, time-lapse video, and focus shift, only settings in the current shooting menu bank are affected.

Option	Default
ISO sensitivity settings	
ISO sensitivity	100
Auto ISO sensitivity control	ON
Maximum sensitivity	25600
Maximum sensitivity with 	Same as without flash
Minimum shutter speed	Auto
White balance	AUTO > Keep white (reduce warm colors)
Fine-tune	A-B: 0, G-M: 0
Set Picture Control	Auto
Active D-Lighting	Off
Photo flicker reduction	OFF

Option	Default
High-frequency flicker reduction	Off
Metering	Matrix metering
Focus mode	Single AF
AF-area mode	Single-point AF
Auto bracketing	Off ¹
Multiple exposure	Off ²
HDR overlay	Off ³

- 1 The number of shots is reset to zero. The bracketing increment for exposure, flash, and white balance bracketing is reset to 1. The amount for the second shot in two-shot ADL bracketing programs is reset to **[Auto]**.
- 2 If a multiple exposure is currently in progress, shooting will end and a multiple exposure will be created from exposures recorded to that point. If **[On (series)]** or **[On (single photo)]** is selected, the multiple exposure mode will be reset to **[Off]**. **[Number of shots]**, **[Overlay mode]**, **[Save individual pictures (RAW)]** and **[Overlay shooting]** are not reset.
- 3 **[On (series)]** and **[On (single photo)]** are reset to **[Off]**. **[HDR strength]** and **[Save individual pictures (RAW)]** are not reset.

Video Recording Menu

Option	Default
ISO sensitivity settings	
Maximum sensitivity	25600
Auto ISO control (mode M)	ON
ISO sensitivity (mode M)	100
White balance	Same as photo settings
Set Picture Control	Same as photo settings
HLG quality	
Quick sharp	0
Contrast	0
Saturation	0
Hue	0
Active D-Lighting	Off
High-frequency flicker reduction	Off
Metering	Matrix metering
Focus mode	Full-time AF
AF-area mode	Single-point AF
Electronic VR	OFF
Hi-Res Zoom	OFF

Custom Settings Menu

Option	Default
a9 [Focus mode restrictions]	No restrictions
d9 [View mode (photo Lv)]	Show effects of settings
d10 [Starlight view (photo Lv)]	OFF
d11 [Warm display colors]	OFF
e2 [Flash shutter speed]	1/60 s
f4 [Control lock]	
[Shutter speed lock]	OFF
[Aperture lock]	OFF
[Focus-point lock]	OFF
g3 [Control lock]	
[Shutter speed lock]	OFF
[Aperture lock]	OFF
[Focus-point lock]	OFF
g5 [Focus mode restrictions]	No restrictions
g8 [Hi-Res Zoom speed]	Standard

Other Settings

Option	Default
Focus point	Center
Preset focus point	Center
Shooting mode	P
Flexible program	Off
Exposure compensation	Off (0.0)
AE lock (hold)	Off
Flash mode	Fill flash
Flash compensation	Off (0.0)
FV lock	Off

Video Recording

Video File Types

Use **[Video file type]** in the video recording menu to choose the video file type.

- You have a choice of NEV, MOV, and MP4 formats.

Option	Description	YCbCr/ Bayer
[N-RAW 12-bit (NEV)]	<p>This option assumes the footage will later undergo RAW processing and editing using a professional high-performance computer system of the type typically employed for editing video (book 217).</p> <ul style="list-style-type: none">• The camera simultaneously records an H.264 8-bit MP4 video (proxy video) at a frame size of 1920 × 1080 for playback on the camera.• You have a choice of two tone modes: [SDR] and [N-Log].• Quality can be adjusted using the [Video quality (N-RAW)] item in the video recording menu.• Audio is recorded in Linear PCM format.	Bayer
[ProRes RAW HQ 12-bit (MOV)]	<p>This option assumes the footage will later undergo RAW processing and editing using a professional high-performance computer system of the type typically employed for editing video (book 217).</p> <ul style="list-style-type: none">• The camera simultaneously records an H.264 8-bit MP4 video (proxy video) at a frame size of 1920 × 1080 for playback on the camera.• You have a choice of two tone modes: [SDR] and [N-Log].• Audio is recorded in Linear PCM format.	Bayer

Option	Description	YCbCr/ Bayer
[ProRes 422 HQ 10-bit (MOV)]	Choose for footage destined for editing post-production. <ul style="list-style-type: none"> • You have a choice of two tone modes: [SDR] and [N-Log]. • Footage is recorded using All-I intra-frame compression. • Audio is recorded in Linear PCM format. 	YCbCr (4:2:2)
[H.265 10-bit (MOV)]	This option assumes the footage will later undergo editing using a professional high-performance computer system of the type typically employed for editing video. <ul style="list-style-type: none"> • You have a choice of three tone modes: [SDR], [HLG], and [N-Log]. • Footage is recorded using long GOP inter-frame compression. • Audio is recorded in Linear PCM format. 	YCbCr (4:2:0)
[H.265 8-bit (MOV)]	This format offers superior compression. <ul style="list-style-type: none"> • Footage is recorded using long GOP inter-frame compression. • Audio is recorded in Linear PCM format. 	
[H.264 8-bit (MP4)]	A widely-supported file type. <ul style="list-style-type: none"> • Footage is recorded using long GOP inter-frame compression. • Audio is recorded in AAC format. 	

Tone Mode

To choose the tone mode, highlight **[N-RAW 12-bit (NEV)]**, **[ProRes RAW HQ 12-bit (MOV)]**, **[ProRes 422 HQ 10-bit (MOV)]**, or **[H.265 10-bit (MOV)]** and press .

- Videos shot using **[H.265 8-bit (MOV)]** and **[H.264 8-bit (MP4)]** use **[SDR]**; tone-mode selection is not available.

Option	Description
[SDR]	This mode supports a normal range of brightnesses (dynamic range).
[HLG]	This mode supports HDR (high dynamic range; 📖 218). It has a wider dynamic range than SDR. <ul style="list-style-type: none">• It is available only when [H.265 10-bit (MOV)] is selected for [Video file type].
[N-Log]	This mode uses Nikon's unique log curve. Choose for pictures with a wide dynamic range. 3D LUTs for use with N-Log curves can be applied post-production for pictures that display beautifully on monitors that support Rec. 709 (📖 221).

Color Space

The color spaces for videos recorded with **[H.265 10-bit (MOV)]**, **[H.265 8-bit (MOV)]**, or **[H.264 8-bit (MP4)]** selected for **[Video file type]** are as follows:

- **[SDR]**: BT.709
- **[HLG]**: BT.2100
- **[N-Log]**: BT.2020

Video Frame Size and Rate Options

Video frame size (in pixels) and frame rate can be selected using **[Frame size/frame rate]** in the video recording menu. The options available for frame size vary with the settings chosen for **[Video file type]** in the video recording menu.

Frame Size and Rate Options for RAW Video

Option	Video file type	
	N-RAW 12-bit	ProRes RAW HQ 12-bit
[[FX] 8256×4644; 60p]	✓	—
[[FX] 8256×4644; 50p]	✓	—
[[FX] 8256×4644; 30p]	✓	—
[[FX] 8256×4644; 25p]	✓	—
[[FX] 8256×4644; 24p]	✓	—
[[FX] 4128×2322; 120p]	✓	—
[[FX] 4128×2322; 100p]	✓	—
[[FX] 4128×2322; 60p]	✓	✓
[[FX] 4128×2322; 50p]	✓	✓
[[FX] 4128×2322; 30p]	✓	✓
[[FX] 4128×2322; 25p]	✓	✓
[[FX] 4128×2322; 24p]	✓	✓
[[DX] 5392×3032; 60p]	✓	—
[[DX] 5392×3032; 50p]	✓	—
[[DX] 5392×3032; 30p]	✓	✓

Option	Video file type	
	N-RAW 12-bit	ProRes RAW HQ 12-bit
[[DX] 5392×3032; 25p]	✓	✓
[[DX] 5392×3032; 24p]	✓	✓
[[2.3×] 3840×2160; 120p]	✓	—
[[2.3×] 3840×2160; 100p]	✓	—
[[2.3×] 3840×2160; 60p]	—	✓
[[2.3×] 3840×2160; 50p]	—	✓

- Regardless of the setting chosen for **[Image area]** > **[Choose image area]** in the video recording menu, “FX” options will be recorded using the **[FX]** image area and “DX” options using the **[DX]** image area. Choosing a “2.3×” option increases the apparent focal length by approximately 2.3× when compared to FX format.
- DX-based video format is selected automatically when a DX lens is attached. “FX” options cannot be selected.

Frame Size and Rate Options for Other Video Formats

Option ¹	Video file type		
	ProRes 422 HQ 10-bit	H.265 10-bit/8-bit	H.264 8-bit
[7680×4320; 30p] ^{2,3}	—	✓	—
[7680×4320; 25p] ^{2,3}	—	✓	—
[7680×4320; 24p] ^{2,3}	—	✓	—
[3840×2160; 120p] ^{2,4}	—	✓	—
[3840×2160; 100p] ^{2,4}	—	✓	—
[3840×2160; 60p] ⁴	✓	✓	—

Option ¹	Video file type		
	ProRes 422 HQ 10-bit	H.265 10-bit/8-bit	H.264 8-bit
[3840×2160; 50p] ⁴	✓	✓	—
[3840×2160; 30p] ⁴	✓	✓	—
[3840×2160; 25p] ⁴	✓	✓	—
[3840×2160; 24p] ⁴	✓	✓	—
[1920×1080; 120p] ²	✓	✓	—
[1920×1080; 100p] ²	✓	✓	—
[1920×1080; 60p]	✓	✓	✓
[1920×1080; 50p]	✓	✓	✓
[1920×1080; 30p]	—	✓	✓
[1920×1080; 25p]	—	✓	✓
[1920×1080; 24p]	—	✓	✓

1 The frame rates for 120p, 100p, 60p, 50p, 30p, 25p, and 24p are respectively 119.88 fps, 100 fps, 59.94 fps, 50 fps, 29.97 fps, 25 fps, and 23.976 fps.

2 Fixes **[Electronic VR]** in the video recording menu at **[OFF]**.

3 Videos are recorded in 8K UHD. Not available with DX lenses.

4 Videos are recorded in 4K UHD.

Bit Rate

The bit rate varies with the video file type.

- In the case of **[N-RAW 12-bit (NEV)]**, the bit rate varies with the option selected for **[Video quality (N-RAW)]** in the video recording menu.
- ProRes RAW HQ 12-bit and ProRes 422 HQ 10-bit data specifications are available from the Apple website.

High-Quality N-RAW 12-Bit NEV

The average bit rates for NEV videos and for the MP4 videos recorded for playback purposes when **[High quality]** is selected for **[Video quality (N-RAW)]** are as follows.

Option	NEV	MP4
[[FX] 8256×4644; 60p]	Approx. 5780 Mbps	Approx. 56 Mbps
[[FX] 8256×4644; 50p]	Approx. 4810 Mbps	
[[FX] 8256×4644; 30p]	Approx. 2890 Mbps	
[[FX] 8256×4644; 25p]	Approx. 2410 Mbps	
[[FX] 8256×4644; 24p]	Approx. 2310 Mbps	
[[FX] 4128×2322; 120p]	Approx. 3840 Mbps	Approx. 120 Mbps
[[FX] 4128×2322; 100p]	Approx. 2900 Mbps	
[[FX] 4128×2322; 60p]	Approx. 1740 Mbps	Approx. 56 Mbps
[[FX] 4128×2322; 50p]	Approx. 1450 Mbps	
[[FX] 4128×2322; 30p]	Approx. 870 Mbps	Approx. 28 Mbps
[[FX] 4128×2322; 25p]	Approx. 730 Mbps	
[[FX] 4128×2322; 24p]	Approx. 700 Mbps	
[[DX] 5392×3032; 60p]	Approx. 2960 Mbps	Approx. 56 Mbps
[[DX] 5392×3032; 50p]	Approx. 2470 Mbps	

Option	NEV	MP4
[[DX] 5392×3032; 30p]	Approx. 1480 Mbps	Approx. 28 Mbps
[[DX] 5392×3032; 25p]	Approx. 1240 Mbps	
[[DX] 5392×3032; 24p]	Approx. 1190 Mbps	
[[2.3×] 3840×2160; 120p]	Approx. 3020 Mbps	Approx. 120 Mbps
[[2.3×] 3840×2160; 100p]	Approx. 2510 Mbps	

Normal-Quality N-RAW 12-Bit NEV

The average bit rates for NEV videos and for the MP4 videos recorded for playback purposes when **[Normal]** is selected for **[Video quality (N-RAW)]** are as follows.

Option	NEV	MP4
[[FX] 8256×4644; 60p]	Approx. 3470 Mbps	Approx. 56 Mbps
[[FX] 8256×4644; 50p]	Approx. 2890 Mbps	
[[FX] 8256×4644; 30p]	Approx. 1740 Mbps	
[[FX] 8256×4644; 25p]	Approx. 1450 Mbps	
[[FX] 8256×4644; 24p]	Approx. 1390 Mbps	
[[FX] 4128×2322; 120p]	Approx. 1750 Mbps	Approx. 120 Mbps
[[FX] 4128×2322; 100p]	Approx. 1460 Mbps	
[[FX] 4128×2322; 60p]	Approx. 880 Mbps	Approx. 56 Mbps
[[FX] 4128×2322; 50p]	Approx. 730 Mbps	
[[FX] 4128×2322; 30p]	Approx. 440 Mbps	Approx. 28 Mbps
[[FX] 4128×2322; 25p]	Approx. 370 Mbps	
[[FX] 4128×2322; 24p]	Approx. 350 Mbps	

Option	NEV	MP4
[[DX] 5392×3032; 60p]	Approx. 1490 Mbps	Approx. 56 Mbps
[[DX] 5392×3032; 50p]	Approx. 1240 Mbps	
[[DX] 5392×3032; 30p]	Approx. 750 Mbps	Approx. 28 Mbps
[[DX] 5392×3032; 25p]	Approx. 620 Mbps	
[[DX] 5392×3032; 24p]	Approx. 600 Mbps	
[[2.3×] 3840×2160; 120p]	Approx. 1510 Mbps	Approx. 120 Mbps
[[2.3×] 3840×2160; 100p]	Approx. 1260 Mbps	

H.265 10-Bit, H.265 8-Bit, and H.264 8-Bit

The average bit rate for each option is shown below.

Option	Video file type		
	H.265 10-bit	H.265 8-bit	H.264 8-bit
[7680×4320; 30p]	Approx. 400 Mbps	Approx. 370 Mbps	—
[7680×4320; 25p]			—
[7680×4320; 24p]			—
[3840×2160; 120p]			—
[3840×2160; 100p]			—
[3840×2160; 60p]	Approx. 340 Mbps	Approx. 300 Mbps	—
[3840×2160; 50p]			—

Option	Video file type		
	H.265 10-bit	H.265 8-bit	H.264 8-bit
[3840×2160; 30p]	Approx. 190 Mbps	Approx. 150 Mbps	—
[3840×2160; 25p]			—
[3840×2160; 24p]			—
[1920×1080; 120p]			—
[1920×1080; 100p]			—
[1920×1080; 60p]	Approx. 100 Mbps	Approx. 80 Mbps	Approx. 50 Mbps
[1920×1080; 50p]			
[1920×1080; 30p]	Approx. 50 Mbps	Approx. 40 Mbps	Approx. 30 Mbps
[1920×1080; 25p]			
[1920×1080; 24p]			

Video Image Area Options

The image area for videos can be selected using **[Image area] > [Choose image area]** in the video recording menu. The crop used for filming video varies with the option selected. Regardless of the option selected, the aspect ratio is 16:9.

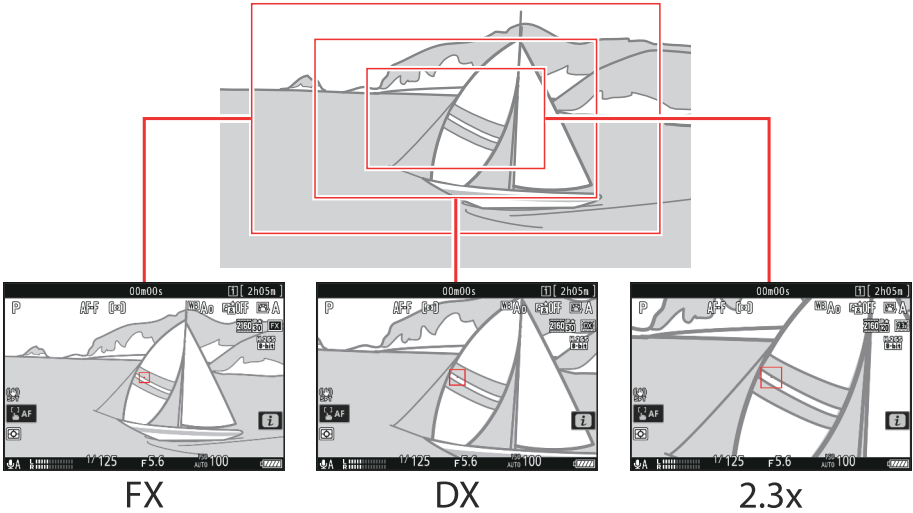

- Select **[FX]** to shoot videos in what is referred to as “FX-based video format”, **[DX]** to shoot in “DX-based video format”.
- The image area for videos recorded with **[N-RAW 12-bit (NEV)]** or **[ProRes RAW HQ 12-bit (MOV)]** selected for **[Video file type]** in the video recording menu is determined by the option chosen for **[Frame size/frame rate]**. The option selected for **[Image area] > [Choose image area]** in the video recording menu does not apply.
- Selecting **[DX]** for **[Choose image area]** or mounting a DX lens on the camera with **[3840×2160; 120p]**, **[3840×2160; 100p]**, **[1920×1080; 120p]**, or **[1920×1080; 100p]** chosen for **[Frame size/frame rate]** increases the apparent focal length by approximately 2.3× when compared to FX format.

- The option currently selected is shown by an icon in the display. If **[ON]** is chosen for **[Image area] > [DX crop alert]** in the video recording menu, an image-area icon will flash in the shooting display when the DX or 2.3× crop is selected.

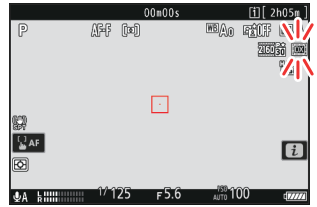

- The sizes of the different crops are shown below.

Format	Size
FX-based video format	Approx. 35.9 × 20.2 mm
DX-based video format	Approx. 23.5 × 13.2 mm
2.3×	Approx. 16.7 × 9.4 mm

- DX-based video format is selected automatically when a DX lens is attached.
- When 7680 × 4320 is selected for frame size, image area is fixed at **[FX]**. The frame size changes to 3840 × 2160 when a DX lens is attached.
- Selecting **[ON]** for **[Electronic VR]** in the video recording menu reduces the size of the crop.

Points to Note When Filming Videos

Note the following points when recording videos:

- Each video can be up to 125 minutes in length.
- Each video recorded to a card with a capacity of 32 GB or less will be saved across a maximum of 8 files. Each of these files will be a maximum of 4 GB in size. The number of files and the length of each file vary with the options selected for [**Frame size/frame rate**].
- If [**ProRes 422 HQ 10-bit (MOV)**] is selected for [**Video file type**] in the video recording menu and the memory card has a capacity of 32 GB or less, recording will automatically end when the file reaches 4 GB in size. Videos are not recorded across multiple files.
- Depending on memory card write speed, shooting may end before the maximum length is reached.
- Video cannot be recorded to XQD memory cards with a capacity of 32 GB or less when [**N-RAW 12-bit (NEV)**] or [**ProRes RAW HQ 12-bit (MOV)**] is selected for [**Video file type**] in the video recording menu.
- A  icon ([98](#)) indicates that videos cannot be recorded.
- [**Spot metering**] is not available during video recording.
- Flash lighting ([404](#)) cannot be used.

Tip: Video Recording: Shooting Mode

The exposure settings that can be adjusted during filming vary with the shooting mode:

Mode	Aperture	Shutter speed	ISO sensitivity ²
P, S ¹	—	—	— ³
A	✓	—	— ³
M	✓	✓	✓ ⁴

1 Exposure control in mode **S** is the same as in mode **P**.

2 The maximum ISO sensitivity for videos recorded with **[ON]** selected for **[Electronic VR]** in the video recording menu is ISO 25600.

3 The upper limit for ISO sensitivity can be selected using the **[ISO sensitivity settings]** > **[Maximum sensitivity]** item in the video recording menu.

4 If **[ON]** is selected for **[ISO sensitivity settings]** > **[Auto ISO control (mode M)]** in the video recording menu, the upper limit for ISO sensitivity can be selected using **[Maximum sensitivity]**.

Tip: Adjusting White Balance During Video Recording

White balance can be adjusted during video recording by holding the **WB** button and rotating a command dial.

Tip: Using a Fixed Shutter Speed

In mode **M**, shutter speed can be set to values between $\frac{1}{25}$ s and $\frac{1}{32000}$ s (the slowest available shutter speed varies with the frame rate).

Tip: Wireless Remote Controllers and Remote Cords

If **[Record videos]** is selected for Custom Setting g2 **[Custom controls]** > **[Shutter-release button]**, the shutter-release buttons on optional wireless remote controllers and remote cords can be pressed halfway to focus or pressed all the way down to start and end video recording.

Tip: Using an External Microphone

Third-party microphones with 3.5 mm mini-jack plugs can be used to record audio for videos.

- Use **[Mic jack plug-in power]** in the video recording menu to choose whether the power for the external microphone is supplied by the camera ([link 556](#)).

RAW Video

“RAW video” refers to video recorded with **[N-RAW 12-bit (NEV)]** or **[ProRes RAW HQ 12-bit (MOV)]** selected for **[Video file type]** in the video recording menu.

✔ Cautions: Recording RAW Video

The following restrictions apply when **[N-RAW 12-bit (NEV)]** or **[ProRes RAW HQ 12-bit (MOV)]** is selected.

- ISO sensitivities of Hi 0.3 through Hi 2.0 are not available.
- **[Active D-Lighting]**, **[High ISO NR]**, **[Diffraction compensation]**, and **[Electronic VR]** are not available in the video recording menu.
- RAW videos cannot be edited on the camera.
- Regardless of the option selected for **[HDMI]** > **[Output resolution]** in the setup menu, the maximum output resolution is 1920 × 1080.
- For information on the cautions that apply when **[N-Log]** is selected for tone mode, see “Recording N-Log Video” ([📖 221](#)).

✔ Viewing and Editing RAW Videos

RAW videos can only be viewed and edited using computer software that supports the RAW video format. Nikon’s NX Studio software supports only the display of the MP4 proxy videos recorded alongside RAW videos.

Recording HLG Video

Video recorded in Hybrid Log Gamma (HLG) format can be used for HDR broadcasting and the like. To record HLG video, select **[H.265 10-bit (MOV)]** for **[Video file type]** in the video recording menu and choose the **[HLG]** tone mode.

- HLG will appear in the shooting display.
- For optimal color reproduction when viewing HLG footage, use computers, operating systems, applications, monitors, and other equipment compatible with HDR.

✓ Cautions: HLG Video

- Selecting **[HLG]** for tone mode rather than **[SDR]** or **[N-Log]** may increase the amount of “noise” (randomly-spaced bright pixels, fog, or lines) visible in the shooting display.
- The lowest value available for the **[ISO sensitivity settings] > [Maximum sensitivity]** item in the video recording menu is ISO 800.
- The lowest value available for the **[ISO sensitivity settings] > [ISO sensitivity (mode M)]** item in the video recording menu is ISO 400.
- ISO sensitivities of Hi 0.3 through Hi 2.0 are not available.
- Picture Control settings cannot be adjusted using the **[Set Picture Control]** item in the video recording menu. You can control the appearance of HLG videos using **[HLG quality]** in the video recording menu.
- The **[Active D-Lighting]** item in the video recording menu is set to **[Off]** and cannot be changed.
- The display in the monitor may flicker or appear grainy.
- The camera may have trouble focusing using autofocus but this does not indicate a malfunction.

✓ HDR (HLG) Output

Optimal color reproduction in HDR (HLG) footage output via HDMI can only be achieved if your storage device, monitor, and other equipment support HDR (HLG). If a signal is received from the connected device indicating that it supports HDR (HLG), the camera will respond with a “gamma: HLG” identifier.

Camera Shooting and Playback Displays

When [HLG] is selected for tone mode, the shooting and playback displays in the camera monitor and viewfinder may include “noise” in the form of randomly-spaced bright pixels, fog, or lines or may fail to accurately reproduce highlights and highly-saturated colors. For accurate tone reproduction, use monitors, computers, operating systems, applications, and other equipment compatible with HLG.

Viewing and Editing HLG Videos

HLG videos can only be viewed and edited using computer software that supports the HLG video format. Nikon’s NX Studio software shows HLG videos in the thumbnail list but cannot be used to view or edit them.

View Assist

You may find that the preview in the shooting display during HLG recording lacks contrast. Selecting [ON] for Custom Setting g11 [**View assist**] simplifies colors for enhanced contrast.

- **ASSIST** will appear in the shooting display.
- Colors in the actual recorded footage are unaffected.
- Contrast is also enhanced when HLG footage is viewed on the camera.

Recording N-Log Video

Log recording uses light levels digitized via a log function. To enable log recording using Nikon's unique "N-Log" log function, select **[N-RAW 12-bit (NEV)]**, **[ProRes RAW HQ 12-bit (MOV)]**, **[ProRes 422 HQ 10-bit (MOV)]**, or **[H.265 10-bit (MOV)]** for **[Video file type]** in the video recording menu and choose **[N-Log]** as the tone mode. Choose N-Log to preserve details in highlights and shadows and avoid over-saturated colors when recording videos.

- **NLOG** will appear in the shooting display.
- The dynamic range for videos shot with **[H.265 10-bit (MOV)]** selected for **[Video file type]** and ISO sensitivity set as low as possible (ISO 800) is 12 stops (1300%).
- N-Log recording is intended for footage that will be processed using color grading post-production. Color grading can be used to achieve multiple effects from a single sequence by processing it in different ways.
- Compatible third-party software is required for color grading.
- Applying N-Log 3D LUTs during color grading produces video that displays beautifully on monitors compatible with Rec. 709.
 - N-Log 3D LUTs are available from the Nikon Download Center.
<https://downloadcenter.nikonimglib.com/>

Cautions: N-Log Video

- The lowest value available for the **[ISO sensitivity settings]** > **[Maximum sensitivity]** item in the video recording menu is ISO 1600.
 - The lowest value available for the **[ISO sensitivity settings]** > **[ISO sensitivity (mode M)]** item in the video recording menu is ISO 800.
 - ISO sensitivities of Hi 0.3 through Hi 2.0 are not available.
 - **[Set Picture Control]** and **[High ISO NR]** are not available in the video recording menu.
 - The **[Active D-Lighting]** item in the video recording menu is set to **[Off]** and cannot be changed.
 - The display in the monitor may flicker or appear grainy.
 - The camera may have trouble focusing using autofocus but this does not indicate a malfunction.
-

View Assist

You may find that the preview in the shooting display during N-Log recording lacks contrast. Selecting [ON] for Custom Setting g11 [**View assist**] simplifies colors for enhanced contrast.

- **ASSIST** will appear in the shooting display.
- Colors in the actual recorded footage are unaffected.
- Contrast is also enhanced when N-Log footage is viewed on the camera.

Hi-Res Zoom

Selecting **[ON]** for **[Hi-Res Zoom]** in the video recording menu lets you zoom in on your subject with no loss in resolution, even without a zoom lens.

- Hi-Res Zoom is available when all the following conditions are met:
 - **[FX]** is selected for **[Image area]** > **[Choose image area]** in the video recording menu,
 - **[ProRes 422 HQ 10-bit (MOV)]**, **[H.265 10-bit (MOV)]**, **[H.265 8-bit (MOV)]**, or **[H.264 8-bit (MP4)]** is selected for **[Video file type]** in the video recording menu, and
 - a frame size and rate of from **[3840×2160; 30p]** to **[3840×2160; 24p]** or from **[1920×1080; 120p]** to **[1920×1080; 24p]** is selected for **[Frame size/frame rate]** in the video recording menu.

Using Hi-Res Zoom

Select **[ON]** for **[Hi-Res Zoom]** in the video recording menu and press **[ZOOM IN]** or **[ZOOM OUT]** to zoom in or out.

- A  icon appears in the display when Hi-Res Zoom is enabled.
- The zoom position is shown by a bar as you zoom in or out. You can zoom in to a maximum of 2.0×.

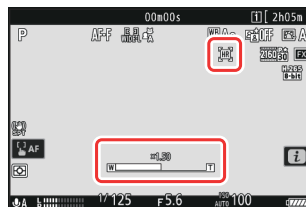

✓ Cautions: Hi-Res Zoom

- AF-area mode is fixed at **[Wide-area AF (L)]**. The focus point is not displayed.
- **[Electronic VR]** in the video recording menu is fixed at **[OFF]**.

Tip: Custom Controls for Hi-Res Zoom

The zoom position for Hi-Res Zoom can also be adjusted using controls to which [**Hi-Res Zoom +**] and [**Hi-Res Zoom -**] have been assigned via Custom Setting g2 [**Custom controls**].

- Zoom control for Hi-Res Zoom can be assigned to the camera [**Fn1 button**] and [**Fn2 button**], to the lens Fn ring via [**Lens Fn ring (clockwise)**] and [**Lens Fn ring (counterclockwise)**], and via [**Lens control ring**] to the lens control ring.
 - When Hi-Res Zoom is assigned to the [**Fn1 button**], [**Fn2 button**], [**Lens Fn ring (clockwise)**], or [**Lens Fn ring (counterclockwise)**], zoom speed can be controlled using Custom Setting g8 [**Hi-Res Zoom speed**], which offers a choice of [**Slower**], [**Standard**], and [**Faster**].
 - When Hi-Res Zoom is assigned to [**Lens control ring**], the control ring response can be adjusted using Custom Setting f10 [**Control ring response**].
 - Instead of using the control ring, users of compatible lenses can employ the focus ring for Hi-Res Zoom by selecting [**ON**] for Custom Setting f11 [**Switch focus/control ring roles**].
-





Viewing and Retouching Pictures

Viewing Pictures

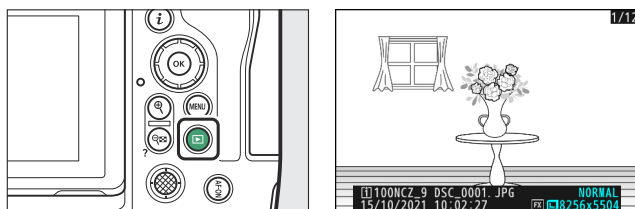
Full-Frame Playback

Press the  button to view the most recent picture full frame in the display.







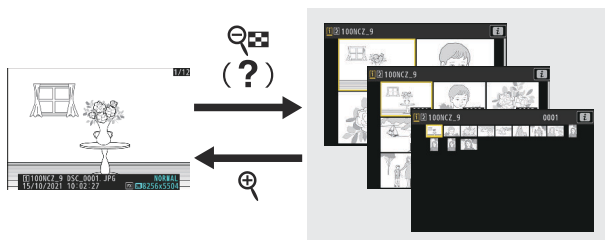
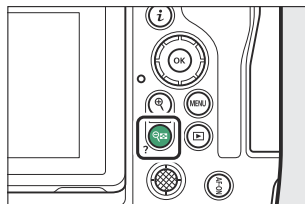

- Press  to return to the previous frame,  to skip to the next frame.
- Press , , or the **DISP** button to view more information on the current picture ([book 228](#)).

Thumbnail Playback

To view multiple pictures, press the  (?) button when a picture is displayed full frame.



- The number of pictures displayed increases from 4 to 9 to 72 each time the  (?) button is pressed, and decreases with each press of the  button.
- Highlight pictures using , , , or .

✔ Touch Controls

Touch controls can be used when pictures are displayed in the monitor ([61](#)).

✔ “Auto-rotate Pictures”

Select **[ON]** for **[Auto-rotate pictures]** in the playback menu to automatically rotate “tall” (portrait) and “wide” (landscape) orientation pictures according to how the camera is held during playback: tall pictures will be rotated to display in tall orientation when the camera is held in wide orientation, while wide pictures will be rotated to display in wide orientation when the camera is held in tall orientation.





✔ Picture Review

When **[On]** is selected for **[Picture review]** in the playback menu, photographs are automatically displayed after shooting; there is no need for you to press the  button.

- If **[On (monitor only)]** is selected, photos will not be displayed in the viewfinder.
 - In continuous release modes, display begins when shooting ends, with the first photograph in the current series displayed.
 - Pictures are not rotated automatically during picture review even when **[ON]** is selected for **[Auto-rotate pictures]** in the playback menu.
-

Photo Information

Photo information is superimposed on pictures displayed in full-frame playback. Press , , or the **DISP** button to cycle through photo information as shown below.

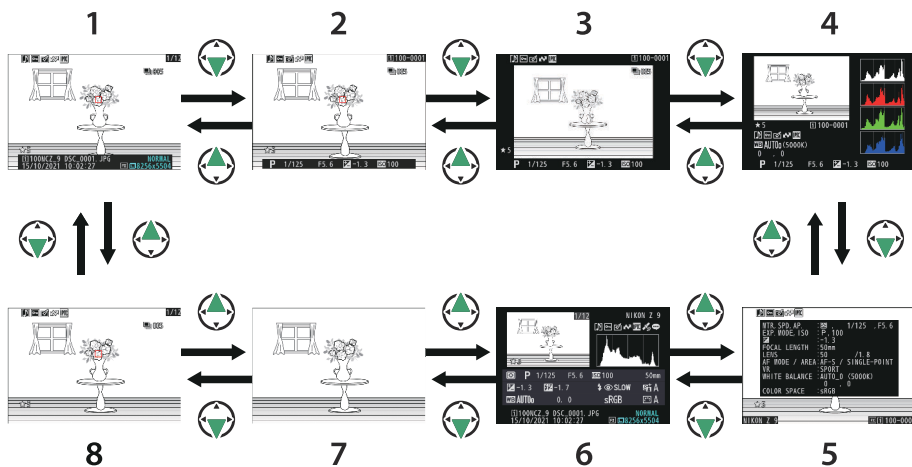

- 1** Basic information
- 2** Exposure data *
- 3** Highlight display *
- 4** RGB histogram *

- 5** Shooting data *
- 6** Overview data *
- 7** None (picture only) *
- 8** File info *

* Displayed only if the corresponding option is selected for **[Playback display options]** in the playback menu.

Basic Information

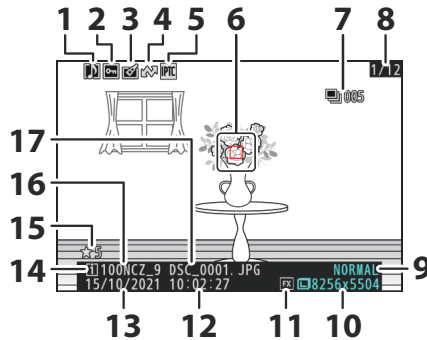

- | | |
|---|--|
| 1 Voice memo indicator (book 292) | 10 Image size (book 108) |
| 2 Protect status (book 248) | 11 Image area (book 104) |
| 3 Retouch indicator (book 260) | 12 Time of recording (book 727) |
| 4 Upload marking (book 251) | 13 Date of recording (book 727) |
| 5 IPTC preset indicator (book 749) | 14 Current card slot |
| 6 Focus point ¹ (book 119) | 15 Rating (book 250) |
| 7 First picture in burst/total number of pictures in burst ² (book 710) | 16 Folder name (book 442) |
| 8 Frame number/total number of frames | 17 File name (book 446) |
| 9 Image quality (book 106) | |

1 Displayed only if **[Focus point]** is selected for **[Playback display options]** in the playback menu.

2 Displayed on the first picture in each burst when **[Mark first shot in series]** is selected for **[Playback display options]** in the playback menu.

Exposure Data

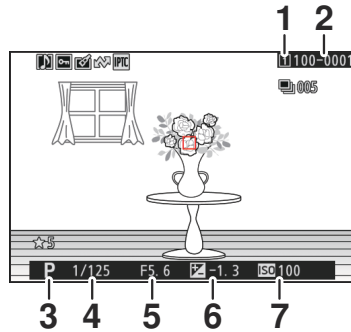

- 1** Current card slot
- 2** Folder number–frame number ([book 442](#))
- 3** Shooting mode ([book 127](#))
- 4** Shutter speed ([book 128](#), [book 129](#))
- 5** Aperture ([book 128](#), [book 129](#))
- 6** Exposure compensation value ([book 137](#))
- 7** ISO sensitivity * ([book 147](#))

* Displayed in red if the picture was taken with auto ISO sensitivity control enabled.

Highlight Display

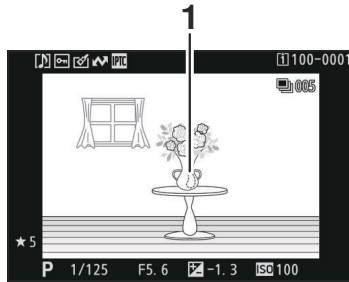

- 1 Highlights (areas that may be overexposed) flash in the display.

RGB Histogram

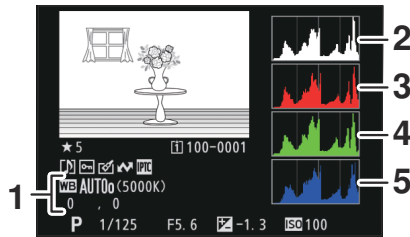

- 1 White balance ([book 151](#))
Color temperature ([book 161](#))
Preset manual ([book 165](#))
White balance fine-tuning ([book 156](#))
- 2 Histogram (RGB channel)
- 3 Histogram (red channel)
- 4 Histogram (green channel)
- 5 Histogram (blue channel)

✓ Playback Zoom

To zoom in on the picture in the histogram display, press \mathcal{Q} . The histogram will be updated to show only the data for the portion of the picture visible in the display. Use the multi selector to scroll to areas of the frame not visible in the monitor. Press \mathcal{Q} (?) to zoom out.

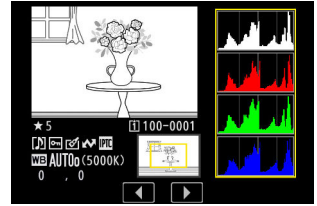

✓ Histograms

Histograms show tone distribution. Pixel brightness (tone) is plotted on the horizontal axis and the number of pixels on the vertical axis.

- If the picture contains objects with a wide range of brightnesses, the distribution of tones will be relatively even.



- If the picture is dark, the distribution will be shifted to the left.



- If the picture is bright, the distribution will be shifted to the right.



Increasing exposure compensation shifts the distribution of tones to the right, while decreasing exposure compensation shifts the distribution to the left. Histograms can provide a rough idea of overall exposure when bright ambient lighting makes it difficult to see pictures in the monitor.

✓ The Histogram Display

- RGB histograms show tone distribution.
- Camera histograms may differ from those displayed in imaging applications. Use them as a guide to actual tone distribution.

Shooting Data

View the settings in effect at the time the picture was taken. The shooting data list has multiple pages, which can be viewed by pressing or . The information displayed can be selected using [Playback display options] > [Detailed shooting data] in the playback menu.

Basic Shooting Data

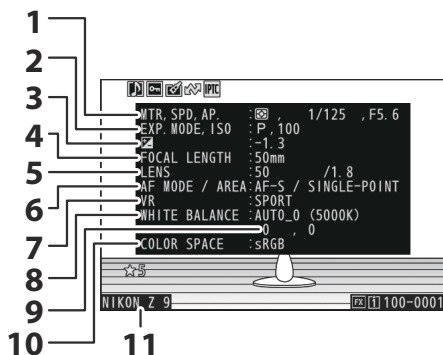

- | | |
|---|--|
| 1 Metering (book 470)
Shutter speed (book 128 , book 129)
Aperture (book 128 , book 129) | 7 Vibration reduction (book 477) |
| 2 Shooting mode (book 127)
ISO sensitivity ¹ (book 147) | 8 White balance ³ (book 151) |
| 3 Exposure compensation value (book 137)
Optimal exposure tuning ² (book 593) | 9 White balance fine-tuning (book 156) |
| 4 Focal length | 10 Color space (book 458) |
| 5 Lens data | 11 Camera name |
| 6 Focus mode (book 110)
AF-area mode (book 112) | |

- 1 Displayed in red if the picture was taken with auto ISO sensitivity control enabled.
- 2 Displayed if Custom Setting b6 [Fine-tune optimal exposure] has been set to a value other than zero.
- 3 Also includes the color temperature for pictures taken using [Auto], [Natural light auto], or PRE [Preset manual].

Flash Data

Flash data are displayed only for pictures taken with optional flash units ([403](#), [414](#)).

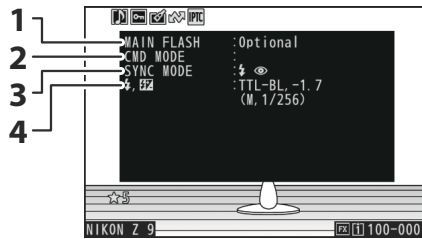

- 1 Flash type
- 2 Remote flash control
- 3 Flash mode ([409](#))
- 4 Flash control mode ([407](#))
Flash compensation ([411](#))

Picture Control/HLG Data

The items displayed vary with the Picture Control in effect when the picture was taken. The display for HLG videos shows the options selected for **[HLG quality]** in the video recording menu.

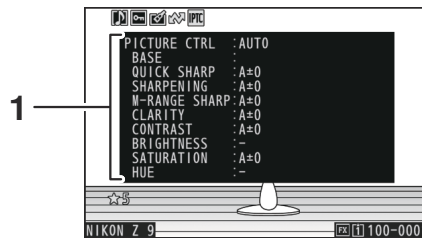

- 1 Picture Control ([183](#))
HLG quality ([538](#))

Other Shooting Data

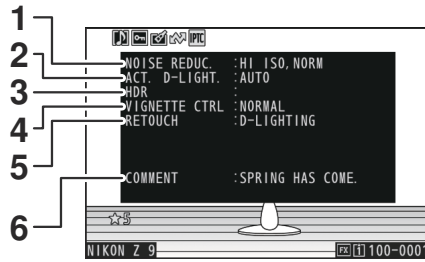

- 1 High ISO NR ([book 462](#))
Long-exposure noise reduction ([book 461](#))
- 2 Active D-Lighting ([book 459](#))
- 3 HDR strength ([book 487](#))
- 4 Vignette control ([book 463](#))
- 5 History of retouches made using [Retouch] option in playback **i** menu ([book 260](#)). Changes are listed in the order applied.
- 6 Image comment ([book 747](#))

Copyright Information

Copyright information is only displayed if recorded using the [Copyright information] item in the setup menu at the time the picture was taken.



- 1 Photographer ([book 748](#))
- 2 Copyright holder ([book 748](#))

Location Data

Location data are displayed only if embedded in the picture at the time it was taken.

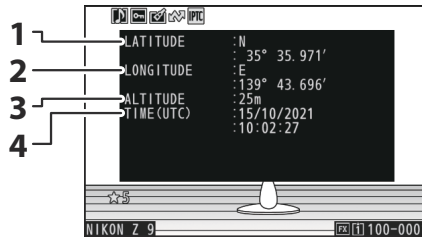

- 1 Latitude
- 2 Longitude

- 3 Altitude
- 4 Universal Coordinated Time (UTC)

IPTC Data

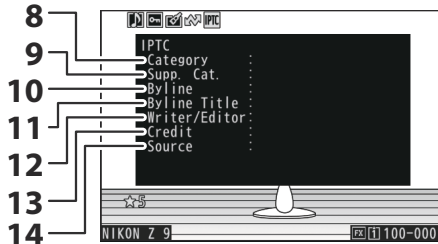
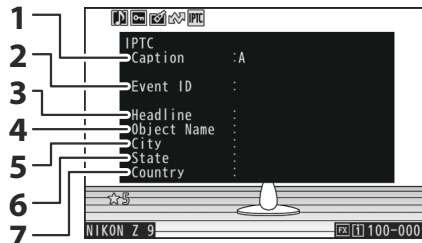

- 1 Caption
- 2 Event ID
- 3 Headline
- 4 Object name
- 5 City
- 6 State
- 7 Country

- 8 Category
- 9 Supp. Cat. (Supplemental categories)
- 10 Byline
- 11 Byline title
- 12 Writer/Editor
- 13 Credit
- 14 Source

Overview

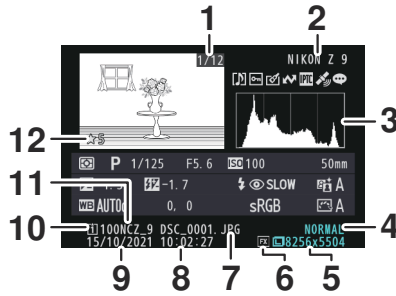

- | | |
|--|--|
| 1 Frame number/total number of frames | 7 File name (446) |
| 2 Camera name | 8 Time of recording (727) |
| 3 Histogram (232) | 9 Date of recording (727) |
| 4 Image quality (106) | 10 Current card slot |
| 5 Image size (108) | 11 Folder name (442) |
| 6 Image area (104) | 12 Rating (250) |

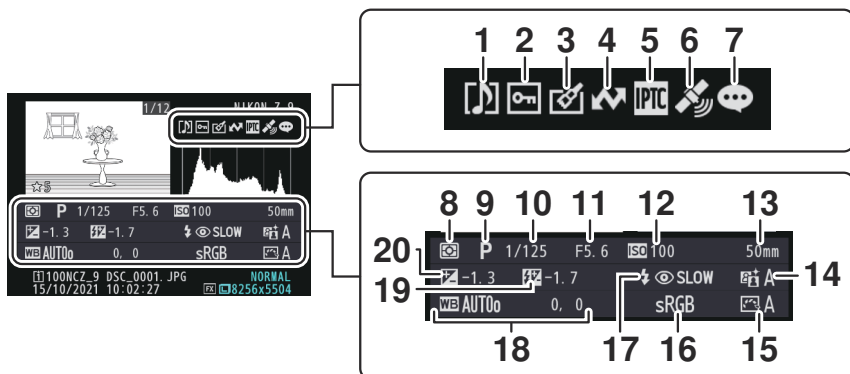

- | | |
|--|--|
| <p>1 Voice memo indicator (book 292)</p> <p>2 Protect status (book 248)</p> <p>3 Retouch indicator (book 260)</p> <p>4 Upload marking (book 251)</p> <p>5 IPTC preset indicator (book 749)</p> <p>6 Location data indicator (book 193)</p> <p>7 Image comment indicator (book 747)</p> <p>8 Metering (book 470)</p> <p>9 Shooting mode (book 127)</p> <p>10 Shutter speed (book 128, book 129)</p> | <p>11 Aperture (book 128, book 129)</p> <p>12 ISO sensitivity ¹ (book 147)</p> <p>13 Focal length</p> <p>14 Active D-Lighting (book 459)</p> <p>15 Picture Control (book 183)</p> <p>16 Color space (book 458)</p> <p>17 Flash mode ² (book 409)</p> <p>18 White balance (book 151)
Color temperature (book 161)
Preset manual (book 165)
White balance fine-tuning (book 156)</p> <p>19 Flash compensation ² (book 411)
Commander mode ²</p> <p>20 Exposure compensation value (book 137)</p> |
|--|--|

1 Displayed in red if the picture was taken with auto ISO sensitivity control enabled.

2 Displayed only if photo was taken with optional flash unit ([book 403](#), [book 414](#)).

File Info

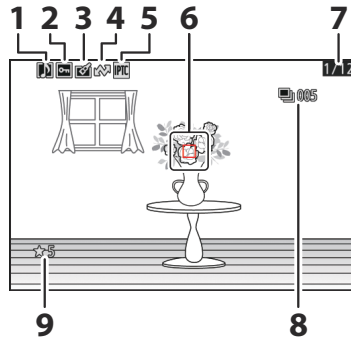

- | | |
|---|--|
| 1 Voice memo indicator (📖 292) | 5 IPTC preset indicator (📖 749) |
| 2 Protect status (📖 248) | 6 Focus point ¹ (📖 119) |
| 3 Retouch indicator (📖 260) | 7 Frame number/total number of frames |
| 4 Upload marking (📖 251) | 8 First picture in burst/total number of pictures in burst ² (📖 710) |
| | 9 Rating (📖 250) |

- 1 Displayed only if **[Focus point]** is selected for **[Playback display options]** in the playback menu.
- 2 Displayed on the first picture in each burst when **[Mark first shot in series]** is selected for **[Playback display options]** in the playback menu.

The **i** Button (Playback Mode)

Pressing the **i** button during playback zoom or full-frame or thumbnail playback displays the **i** menu for playback mode. Highlight items and press **OK** or **▶** to select.

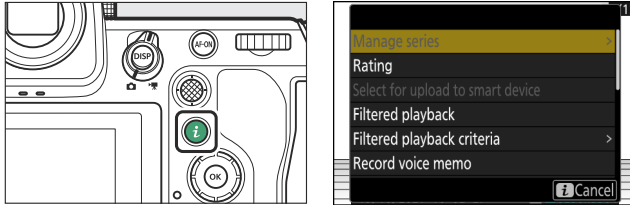

Press the **i** button again to return to playback.

Photos

Option	Description
[Quick crop] ¹	Save a copy of the current picture cropped to the area visible in the display. This option is not available when RGB histograms are displayed (link 231).
[Manage series]	If [ON] is selected for [Series playback] > [List series as single thumbnails] in the playback menu, you can use this option to delete, protect, or mark for upload the current picture and all other pictures in the same burst. <ul style="list-style-type: none">• Note that the pictures can be marked for upload to a computer or FTP server only.
[Rating]	Rate the current picture (link 250).
[Select for upload to smart device]	Select the current picture for upload (link 251). The option displayed varies with the destination currently selected for upload.
[Select for upload to computer]	
[Select for upload (FTP)]	

Option	Description
[Select all for computer upload]	Mark for upload all pictures meeting the current filter criteria (📖 252).
[Select all for upload (FTP)]	<ul style="list-style-type: none"> • These options are displayed only if the camera is connected to a computer or FTP server. • Videos over 4 GB in size cannot be selected for upload.
[Filtered playback]	View only pictures that match selected criteria (📖 252).
[Filtered playback criteria]	Choose filter criteria.
[Record voice memo]	Add a voice memo to the current picture (📖 292).
[Play voice memo]	Play the voice memo for the current picture (📖 294).
[Retouch]	Create a retouched copy of the current picture (📖 260).
[Jump to copy on other card]	If the current picture is one of a pair created with [Backup] , [RAW Slot 1 - JPEG Slot 2] , or [JPEG Slot 1 - JPEG Slot 2] selected for [Role played by card in Slot 2] in the photo shooting menu, choosing this option displays the copy on the card in the other slot.
[Choose slot and folder]	Choose a slot and folder for playback. Highlight a slot and press ⏪ to display a list of the folders on the memory card in the selected slot. You can then highlight a folder and press ⏩ to view the pictures it contains.
[Protect]	Add protection to or remove protection from the current picture (📖 248).
[Unprotect all] ²	Remove protection from all pictures in the folder currently selected for [Playback folder] in the playback menu.
[IPTC]	Embed a selected IPTC preset in the current photo (📖 749).
[Side-by-side comparison] ³	Compare retouched copies to the originals.
[Slide show]	View a slide show; the current picture and all following pictures are displayed one at a time in the order recorded (📖 254).

1 Available only during playback zoom.

- 2 Not available during playback zoom.
- 3 Available only when a retouched copy (indicated by a  icon) or the source picture for a retouched copy is selected.

Tip: [Side-by-Side Comparison]

Choose [**Side-by-side comparison**] to compare retouched copies with the unretouched originals.

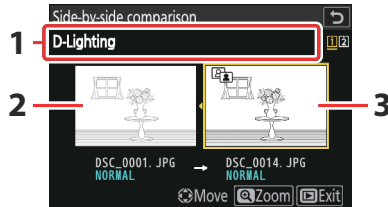

1 Options used to create copy

3 Retouched copy



2 Source picture

- The source picture is displayed on the left, the retouched copy on the right.
 - The options used to create the copy listed at the top of the display.
 - Press or to switch between the source picture and the retouched copy.
 - If the copy is an overlay created from multiple source pictures, press or to view the other pictures.
 - If the source has been copied multiple times, press or to view the other copies.
 - To view the highlighted picture full screen, press and hold the button.
 - Press to return to playback with the highlighted picture displayed fullframe.
 - To exit to playback, press the button.
 - The source picture will not be displayed if the copy was created from a photograph that is now protected.
 - The source picture will not be displayed if the copy was created from a photograph that has since been deleted.
-

Videos

Option	Description
[Rating]	Rate the current picture (📖 250).
[Select for upload to computer]	Select the current picture for upload (📖 251). These options are displayed only if the camera is connected to a computer or FTP server.
[Select for upload (FTP)]	
[Select all for computer upload]	Mark for upload all pictures meeting the current filter criteria (📖 252).
[Select all for upload (FTP)]	<ul style="list-style-type: none">• These options are displayed only if the camera is connected to a computer or FTP server.• Videos over 4 GB in size cannot be selected for upload.
[Filtered playback]	View only pictures that match selected criteria (📖 252).
[Filtered playback criteria]	Choose filter criteria.
[Volume control]	Adjust playback volume.
[Trim video]	Trim footage from the current video and save the edited copy in a new file (📖 285).
[Choose slot and folder]	Choose a slot and folder for playback. Highlight a slot and press ⏏ to display a list of the folders on the memory card in the selected slot. You can then highlight a folder and press Ⓜ to view the pictures it contains.
[Protect]	Add protection to or remove protection from the current picture (📖 248).
[Unprotect all]	Remove protection from all pictures in the folder currently selected for [Playback folder] in the playback menu.
[Slide show]	View a slide show; the current picture and all following pictures are displayed one at a time in the order recorded (📖 254).

Videos (Playback Paused)

Option		Description
	[Trim video]	Trim unwanted footage (book 285).
	[Save current frame]	Save a selected frame as a JPEG still (book 289).
	[Save consecutive frames]	Save the frames in a selected length of footage as a series of individual JPEG images (book 290).
[Volume control]		Adjust playback volume.

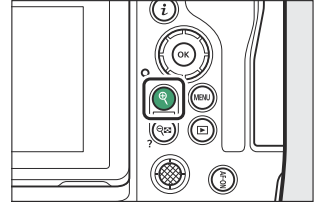

Playback Zoom

To zoom in on a photo displayed in full-frame playback, press **Q** or **Ⓢ** or give the display two quick taps. **[FX (36×24)]**-format photos can be zoomed in to a maximum of approximately 32× (**Large** pictures), 24× (**Medium**), or 16× (**Small**). Faces detected during zoom are indicated by white borders; rotate the sub-command dial to view other faces.

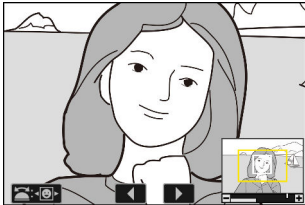

Using Playback Zoom

To	Description
Zoom in/zoom out	<ul style="list-style-type: none">• Press the Q button or use stretch gestures to zoom in.• To zoom out, press Q (?) or use pinch gestures.• A navigation window is displayed during the zoom ratio is altered, with the area currently visible indicated by a yellow border. A bar below the navigation window shows the zoom ratio, turning green at 1 : 1 (100%). The navigation window clears from the display after a few seconds. 
View other areas of picture	Use the multi selector or glide gestures to view areas of the picture not visible in the monitor. Keep the multi selector pressed to scroll rapidly to other areas of frame.
Crop picture	To crop the picture to the area currently visible in the monitor, press i and select [Quick crop] .

To	Description
Select faces	<p>Faces detected during zoom are indicated by white borders in the navigation window. Rotate the sub-command dial or tap the on-screen guide to view other faces.</p> 
View other pictures	<p>Rotate the main command dial to view the same location in other photos without changing the zoom ratio (selecting a video cancels zoom). You can also view other photos by tapping the ◀ or ▶ icon at the bottom of the display.</p>
Protect pictures	<p>Press the Fn (Fn4) button to toggle protection for the current picture on or off (248).</p>
Exit to shooting mode	<p>Press the shutter-release button halfway or press the  button to exit.</p>
View menus	<p>Press the MENU button to view the menus.</p>



Protecting Pictures from Deletion

Pictures can be protected to prevent their being deleted accidentally. Protected pictures will however be deleted when the memory card is formatted ([724](#)).

1 Select a picture.

- Display the picture in full-frame playback or playback zoom.
- Alternatively, you can highlight the picture in the thumbnail list using the multi selector.

2 Press the (Fn4) button.

- Protected pictures are marked with a  icon.
- To remove protection, display the picture or highlight it in the thumbnail list and press  (Fn4) again.

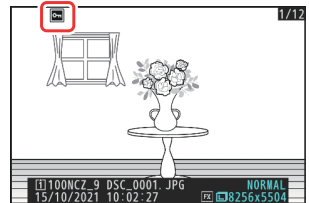
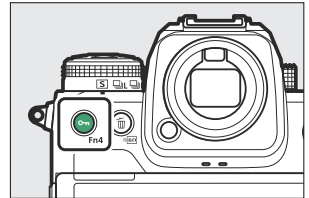

✔ Voice Memos

Protecting photos also protects any voice memos recorded with the pictures. Voice memos cannot be protected separately.

✔ Caution: Uploading Protected Pictures via FTP

The copies on the FTP server will not be protected even if the originals are. Markings can be added using ratings.

Tip: Removing Protection from All Pictures

To remove protection from all pictures in the folder or folders currently selected for **[Playback folder]** in the playback menu, press the **Fn** (**Fn4**) and  (**REMOVE**) buttons for about two seconds during playback.

Rating Pictures

Rate pictures.

- 1 Select the desired picture with the multi selector and press the **i** button.

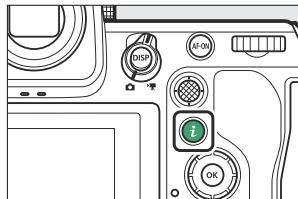

- 2 Highlight [Rating] and press **⏏**.

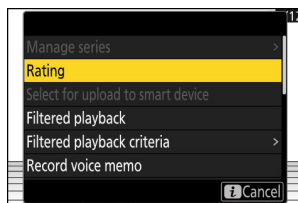

- 3 Choose a rating.

Rotate the main command dial to highlight the desired rating and press **⏏** to select. Choose from ratings of from zero to five stars, or select **🗑️** to mark the picture as a candidate for later deletion.

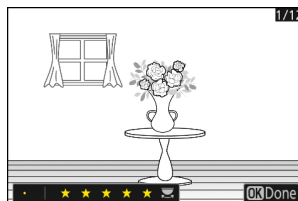

Tip: Ratings

Ratings can also be viewed in NX Studio.

Tip: Rating Pictures Using Camera Controls

If [**Rating**] has been assigned to a control using Custom Setting f3 [**Custom controls (playback)**], pictures can be rated by holding the control and rotating the main command dial.

Selecting Pictures for Upload



Follow the steps below to select the current picture for upload to a smart device, computer, or ftp server.

- The **i** menu items used to select pictures for upload vary with the type of device connected:
 - **[Select for upload to smart device]**: Displayed when the camera is connected to a smart device using **[Connect to smart device]** in the network menu ([📖 783](#)).
 - **[Select for upload to computer]**: Displayed when the camera is connected to a computer using **[Connect to computer]** in the network menu ([📖 787](#)).
 - **[Select for upload (FTP)]**: Displayed when the camera is connected to an FTP server using **[Connect to FTP server]** in the network menu ([📖 792](#)).
- Videos cannot be selected for upload when the camera is connected to a smart device via the SnapBridge app.
- The maximum file size for videos uploaded by other means is 4 GB.

1 Select the desired picture and press the **i** button.

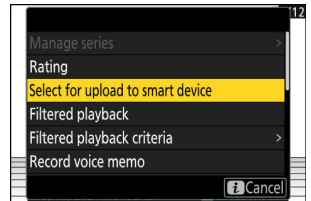
2 Highlight **[Select for upload to smart device]**, **[Select for upload to computer]**, or **[Select for upload (FTP)]** and press **OK**.



Pictures destined for a smart device are marked with a  icon, while those destined for a computer or ftp server are marked with .

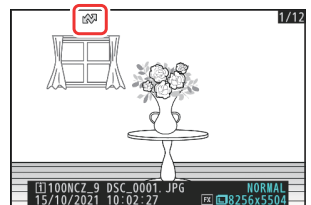

✓ Removing Upload Marking

To remove upload marking, repeat Steps 1 and 2.

Filtered Playback

Select **[Filtered playback]** in the **z** menu to view only pictures that meet the criteria chosen for **[Filtered playback criteria]** in the playback menu or playback **z** menu.

[Filtered Playback Criteria]

Highlight options and press **@** to select () or deselect () . During filtered playback, only pictures that meet all criteria marked with a check () will be displayed.

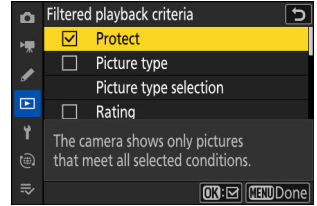

Option	Description
[Protect]	<input checked="" type="checkbox"/> : Include protected pictures.
[Picture type]	<input checked="" type="checkbox"/> : Include pictures of the selected types.
[Rating]	<input checked="" type="checkbox"/> : Include pictures with selected ratings.
[Select for upload to computer]	<ul style="list-style-type: none">• Select (<input checked="" type="checkbox"/>) [Uploaded pictures] to include pictures previously uploaded to a computer or ftp server.• Select (<input checked="" type="checkbox"/>) [Pictures not uploaded] to include pictures that have yet to be uploaded.• Select (<input checked="" type="checkbox"/>) both options to include both pictures that have and pictures that have yet to be uploaded.
[Select for upload (FTP)]	
[Voice memo]	<input checked="" type="checkbox"/> : Include pictures with voice memos.
[Retouched pictures]	<input checked="" type="checkbox"/> : Include retouched pictures.

- During filtered playback, a white border appears around the display.
- To end filtered playback, select [**Filtered playback**] again.

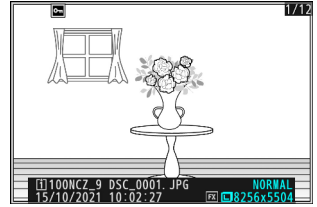

Viewing Slide Shows

To view a slide show in which pictures are played back one at a time in the order recorded, select [**Slide show**] in the **i** menu. You can also choose how long any photos in the show are displayed.

1 Select the starting picture using the multi selector and press the **i button.**

The slide show starts with the selected picture and continues through all the pictures recorded after it.

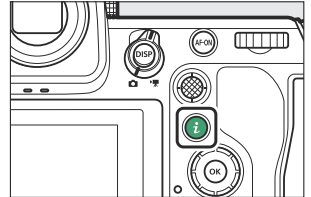

2 Highlight [Slide show**] and press **OK**.**

To choose how long photos are displayed, highlight [**Frame interval**] and press **OK**.

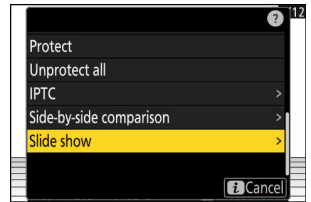

3 Highlight [Start**] and press **OK**.**

- The slide show will start.
- In the case of videos, the option selected for [**Frame interval**] is ignored; instead, the starting frame will be displayed for short time before video playback begins.
- When the show ends, a message will be displayed before normal playback resumes.

During the Show

The following operations can be performed while the show is in progress:

To	Description
Skip back/skip ahead	Press ⏮ to return to the previous frame, ⏭ to skip to the next frame.
View additional photo info	Press ⓘ, ⏏, or DISP to choose the photo info displayed. To hide photo info, select [None (picture only)].
Adjust volume	Press 🔊 to increase volume, 🔇 (?) to decrease.
Exit to playback mode	Press ▶ to end the slide show and return to the playback display.

Deleting Pictures

Follow the steps below to delete pictures from memory cards. Note that pictures cannot be recovered once deleted. Pictures that are protected, however, cannot be deleted.

Using the Delete Button

Press the  (DELETE) button to delete the current picture.

1 Select the desired picture with the multi selector and press the  (DELETE) button.

- A confirmation dialog will be displayed.
- To exit without deleting the picture, press .

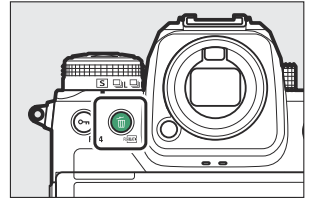

2 Press the  (DELETE) button again.

The picture will be deleted.

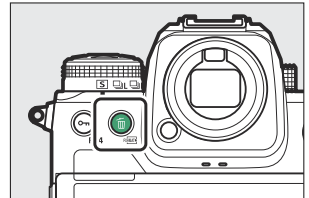



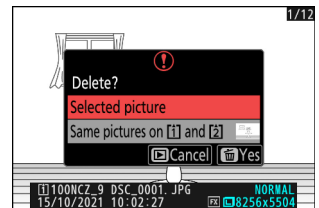

Tip: Deleting Copies

If the picture selected in the playback display when the  (DELETE) button is pressed was recorded with two memory cards inserted and an option other than **[Overflow]** selected for **[Role played by card in Slot 2]**, you will be prompted to choose whether to delete both copies or only the copy on the card in the current slot ([447](#)).







Deleting Multiple Pictures

Use **[Delete]** in the playback menu to delete multiple pictures at once. Note that depending on the number of pictures, some time may be required for deletion.

Option		Description
	[Selected pictures]	Delete selected pictures.
	[Candidates for deletion]	Delete pictures rated  (candidate for deletion).
	[Pictures shot on selected dates]	Delete all pictures taken on selected dates (book 258).
ALL	[All pictures]	Delete all pictures in the folder currently selected for [Playback folder] in the playback menu. <ul style="list-style-type: none">• If two memory cards are inserted, you can select the card from which pictures will be deleted.

Deleting Selected Pictures

1 Select pictures.

- Highlight pictures and press the  (?) button to select; selected pictures are marked with a check (). To remove the check () and deselect the current picture, press the  (?) button again.

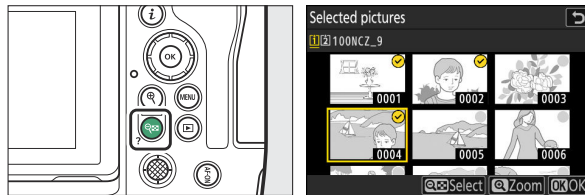

- Repeat until all the desired pictures are selected.
- To view the highlighted picture full screen, press and hold the  button.

2 Delete the pictures.

- Press **⌘**; a confirmation dialog will be displayed.
- Highlight **[Yes]** and press **⌘** to delete the selected pictures.

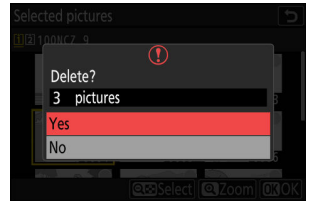

Candidates for Deletion

1 Select pictures.

- The camera will list all pictures rated **⚠** (candidate for deletion). Pictures you do not currently wish to delete can be deselected by highlighting them using the multi selector and pressing **⌘ (?)**.
- To view the highlighted picture full screen, press and hold the **⌘** button.

2 Delete the pictures.

- Press **⌘**; a confirmation dialog will be displayed.
- Highlight **[Yes]** and press **⌘** to delete the selected pictures.

Pictures Shot on Selected Dates

1 Select dates.

- Highlight dates using the multi selector and press **⌘** to select; selected dates are marked with **☑** icons. Selected dates can be deselected by pressing **⌘** again.
- Repeat until you have selected all the desired dates.

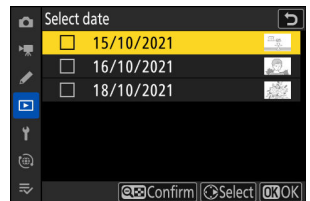

2 Delete the pictures.

- Press **[OK]**; a confirmation dialog will be displayed.
- Highlight **[Yes]** and press **[OK]** to delete all the pictures taken on the selected dates.

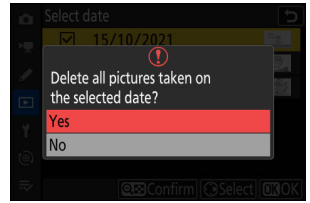

Deleting All Pictures

1 Choose a memory card.

Press **[Left]** or **[Right]** to highlight the slot containing the memory card from which the pictures will be deleted and press **[OK]**.

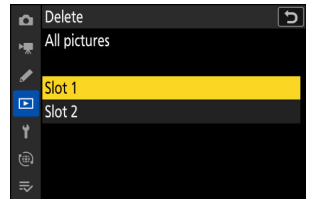

2 Delete the pictures.

- A confirmation dialog will be displayed showing the name of the folder containing the photos to be deleted. Highlight **[Yes]** and press **[OK]** to delete all pictures from the folder. The folder is that previously selected via **[Playback folder]** in the playback menu.
- Note that depending on the number of pictures, some time may be required for deletion.

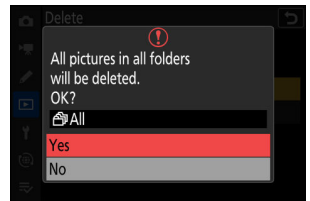

Creating Retouched Copies

Retouched copies can be created from existing pictures. Retouched copies are saved to new files, separate from the original pictures.

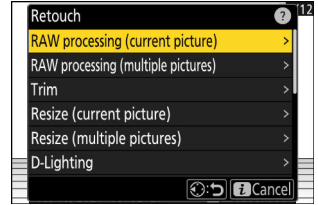

Option	Description
[RAW processing (current picture)]	Save a copy of the current NEF (RAW) picture in another format such as JPEG (book 263).
[RAW processing (multiple pictures)]	Select multiple existing NEF (RAW) pictures for conversion to JPEG or other formats (book 265).
[Trim]	Create a cropped copy of the current photograph (book 268).
[Resize (current picture)]	Create a small copy of the current photograph (book 269).
[Resize (multiple pictures)]	Create small copies from one or more existing photos (book 270).
[D-Lighting]	Brighten shadows (book 273).
[Straighten]	Straighten pictures (book 273).
[Distortion control]	Reduce barrel distortion in pictures taken with wide-angle lenses or pin-cushion distortion in pictures taken with telephoto lenses (book 274).
[Perspective control]	Reduce the effects of perspective (book 275).
[Monochrome]	Create a monochrome copy of the current photograph (book 276).
[Overlay (add)]	Overlay two pictures to create a new picture in JPEG format (book 277).

Option	Description
[Lighten]	Compare the pixels at each point in multiple pictures and select the brightest to create a new picture in JPEG format (book 279).
[Darken]	Compare the pixels at each point in multiple pictures and select the darkest to create a new picture in JPEG format (book 279).
[Motion blend]	The camera examines a selected burst of pictures to detect moving subjects and overlays them to create a single JPEG image (book 283).

1 Select the desired picture with the multi selector and press the *i* button.

You will not need to select a picture if you are using **[RAW processing (multiple pictures)]** or **[Resize (multiple pictures)]**, as you will be prompted to choose the pictures later.

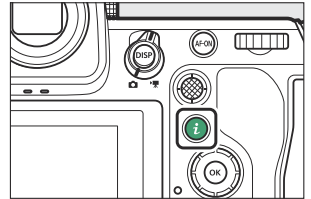

2 Highlight [Retouch] and press \odot .

3 Highlight the desired option and press \odot .

4 Select retouch options.

- For more information, see the section for the selected item.
- To exit without creating a retouched copy, press \blacktriangleright . This will return you to the playback display.

5 Create a retouched copy.

- For more information, see the section for the selected item.
- Retouched copies are indicated by a  icon.

✓ Cautions: Retouch

- The camera may not be able to display or retouch images that were taken or retouched using other cameras or that have been retouched on a computer.
- If no actions are performed for a brief period, the display will turn off and any unsaved changes will be lost. To increase the time the display remains on, choose a longer menu display time using Custom Setting c3 **[Power off delay]** > **[Menus]**.

✓ Cautions: Retouching Copies

- Most items can be applied to copies created using other retouch options, although multiple edits may result in reduced image quality or unnatural colors.
- The effect produced may vary with the order in which edits are performed.
- Some items may be unavailable depending on the items used to create the copy.
- **[Retouch]** items in the **i** menu that cannot be applied to the current picture are grayed out and unavailable.

✓ Image Quality

- Copies created from NEF (RAW) pictures are saved at an **[Image quality]** of **[JPEG fine ★]**.
- Copies created from JPEG pictures are the same quality as the original.
- In the case of dual-format pictures recorded to the same memory card at image-quality settings of RAW+ JPEG, only the NEF (RAW) copy will be retouched.

✓ Image Size

Except in the case of copies created with **[RAW processing (current picture)]**, **[RAW processing (multiple pictures)]**, **[Trim]**, **[Resize (current picture)]**, and **[Resize (multiple pictures)]**, copies are the same size as the original.

RAW Processing

RAW processing is used to save NEF (RAW) pictures in other formats, such as JPEG. Use **[RAW processing (current picture)]** to process the current picture, or **[RAW processing (multiple pictures)]** to process multiple pictures.

✓ Caution: RAW Processing

RAW processing is available only with NEF (RAW) images created with this camera. Pictures in other formats and NEF (RAW) photos taken with other cameras, Camera Control Pro 2, or NX Tether cannot be selected.

Processing the Current Picture

- 1 Select **[Retouch]** in the **i** menu, then highlight **[RAW processing (current picture)]** and press **↵**.

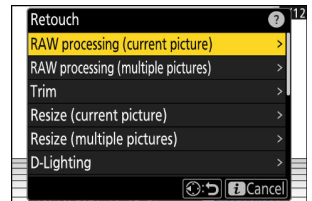

- 2 Choose a destination.

- Press **↵** or **⏪** to highlight a card slot and press **⏩**.
- You will not be prompted to select the slot if only one memory card is inserted.



3 Choose settings for the JPEG copy.

- The settings in effect when the photograph was taken will in some cases appear below the preview.
- To use the setting in effect when the photograph was taken, if applicable, select **[Original]**.

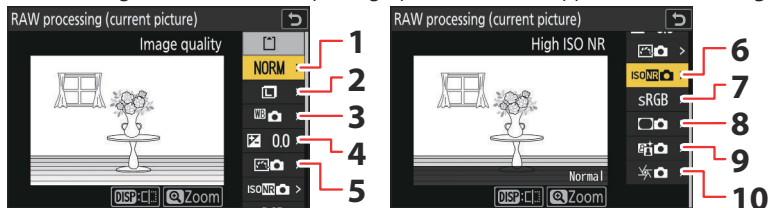

- | | |
|--|--|
| 1 Image quality (book 106) | 6 High ISO NR (book 462) |
| 2 Image size (book 108) | 7 Color space (book 458) |
| 3 White balance (book 151) | 8 Vignette control (book 463) |
| 4 Exposure compensation (book 137) | 9 Active D-Lighting (book 459) |
| 5 Set Picture Control (book 183) | 10 Diffraction compensation (book 464) |

- The effects can be previewed in the edit display. To view the unedited picture, press and hold the **DISP** button.
- **[Exposure compensation]** can only be set to values between -2 and +2 EV.

4 Copy the photograph.

Highlight **[EXE]** and press **Ⓢ** to create a JPEG copy of the selected photographs.

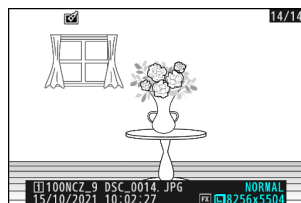

Processing Multiple Pictures

1 Select [Retouch] in the *i* menu, then highlight [RAW processing (multiple pictures)] and press \odot .

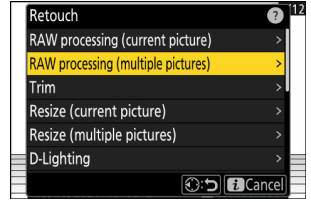

2 Choose how pictures are selected.

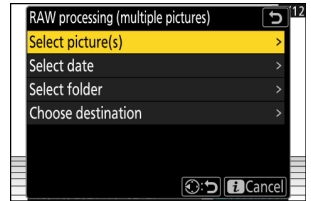

Option	Description
[Select picture(s)]	Create JPEG copies of selected NEF (RAW) pictures. Multiple NEF (RAW) pictures can be selected.
[Select date]	Create JPEG copies of all NEF (RAW) pictures taken on selected dates.
[Select folder]	Create JPEG copies of all NEF (RAW) pictures in a selected folder.
[Choose destination]	Choose the destination for the JPEG copies. You will not be prompted to select the slot if only one memory card is inserted.

If you chose [Select picture(s)], proceed to Step 4.

3 Select the source slot.

- Highlight the slot with the card containing the NEF (RAW) images and press **▶**.
- You will not be prompted to select the slot if only one memory card is inserted.

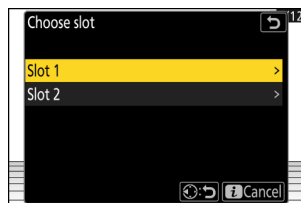

4 Select photographs.

If you chose [Select picture(s)]:

- Highlight pictures using the multi selector.
- To view the highlighted picture full screen, press and hold the **Q** button.
- To select the highlighted picture, press the **Q** (?) button. Selected pictures are marked with a check (**✓**). To remove the check (**○**) and deselect the current picture, press the **Q** (?) button again. All pictures will be processed using the same settings.
- Press **Ⓜ** to proceed once selection is complete.

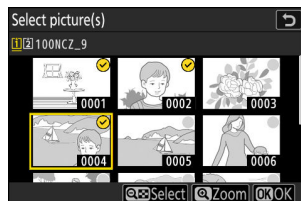

If you chose [Select date]:

- Highlight dates using the multi selector and press **▶** to select (**☑**) or deselect (**☐**).
- All images taken on dates marked with a check (**☑**) will be processed using the same settings.
- Press **Ⓜ** to proceed once selection is complete.

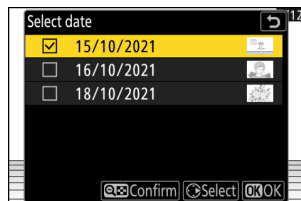

If you chose [Select folder]:

Highlight a folder and press **Ⓜ** to select; all images in the selected folder will be processed using the same settings.

5 Choose settings for the JPEG copies.

- To use the settings in effect when the photographs were taken, if applicable, select **[Original]**.

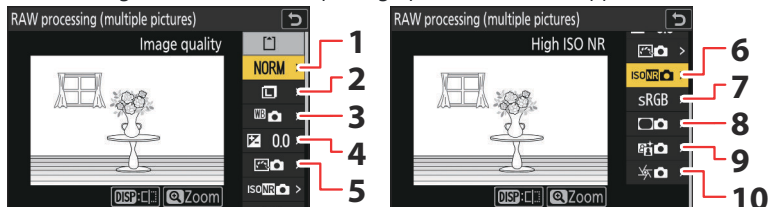

- 1 Image quality ([book 106](#))
- 2 Image size ([book 108](#))
- 3 White balance ([book 151](#))
- 4 Exposure compensation ([book 137](#))
- 5 Set Picture Control ([book 183](#))
- 6 High ISO NR ([book 462](#))
- 7 Color space ([book 458](#))
- 8 Vignette control ([book 463](#))
- 9 Active D-Lighting ([book 459](#))
- 10 Diffraction compensation ([book 464](#))

- The effects can be previewed in the edit display. To view the unedited picture, press and hold the **DISP** button.
- [Exposure compensation]** can only be set to values between -2 and +2 EV.

6 Copy the photographs.

- Highlight **[EXE]** and press **⊗** to display a confirmation dialog and then highlight **[Yes]** and press **⊗** to create JPEG copies of the selected photos.
- To cancel the operation before all copies have been created, press the **MENU** button; when a confirmation dialog is displayed, highlight **[Yes]** and press **⊗**.

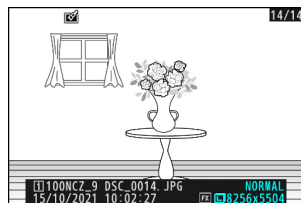

Trim

Create a cropped copy of the current photograph. The photograph is displayed with the selected crop shown in yellow; create a cropped copy as described below.

To	Description
Size the crop	Press \mathcal{R} or \mathcal{R} (?) to choose the crop size.
Change the crop aspect ratio	Rotate the main command dial to choose the crop aspect ratio.
Position the crop	Use the multi selector to position the crop.
Save the crop	Press \mathcal{O} to save the current crop as a separate file.

✓ Cautions: Cropped Pictures

- Depending on the size of the cropped copy, playback zoom may not be available when cropped copies are displayed.
- The crop size appears at upper left in the crop display. The size of the copy varies with crop size and aspect ratio.

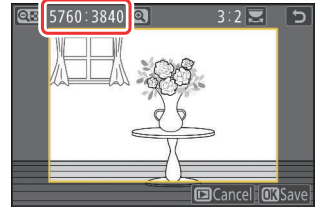

Resize

Create small copies of selected photographs. Use **[Resize (current picture)]** to resize the current picture, or **[Resize (multiple pictures)]** to resize multiple pictures.

✓ Caution: Resize

Depending on the copy size, playback zoom may not be available when resized copies are displayed.

✓ Resizing Cropped Pictures

Pictures cropped to aspect ratios of 4 : 3 or 3 : 4 cannot be resized.

Resizing the Current Picture

- 1 Select **[Retouch]** in the **i** menu, then highlight **[Resize (current picture)]** and press **↵**.

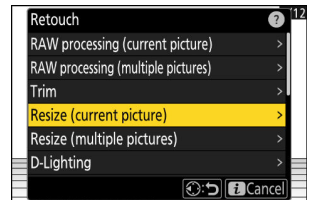

- 2 Choose a destination.

- Press **↶** or **↷** to highlight a card slot and press **↵**.
- You will not be prompted to select the slot if only one memory card is inserted.



- 3 Highlight the desired size and press **↵**.

A copy will be saved at the selected size.

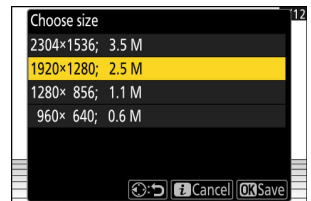

Resizing Multiple Pictures

1 Select [Retouch] in the *i* menu, then highlight [Resize (multiple pictures)] and press \odot .

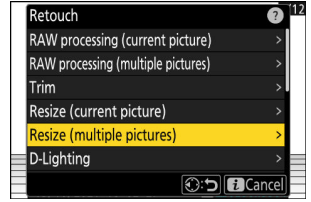

2 Choose a size.

- Highlight [Choose size] and press \odot .

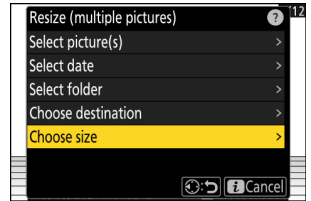

- Highlight the desired size (length in pixels) using \odot and \odot and press \otimes .



3 Choose how pictures are selected.

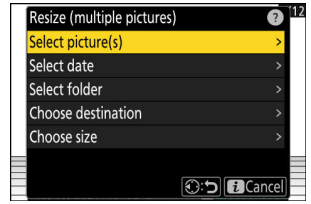

Option	Description
[Select picture(s)]	Resize selected pictures. Multiple pictures can be selected.
[Select date]	Resize all pictures taken on selected dates.
[Select folder]	Resize all pictures in a selected folder.

If you chose [**Select picture(s)**], proceed to Step 5.

4 Select the source slot.

- Highlight the slot with the card containing the desired pictures and press ⏪.
- You will not be prompted to select the slot if only one memory card is inserted.



5 Choose pictures.

If you chose [Select picture(s)]:

- Highlight pictures using the multi selector.
- To view the highlighted picture full screen, press and hold the **Q** button.
- To select the highlighted picture, press the **Q** (?) button. Selected pictures are marked with a check (✓). To remove the check (○) and deselect the current picture, press the **Q** (?) button again. The selected pictures will all be copied at the size selected in Step 2.
- Press **⊗** to proceed once selection is complete.

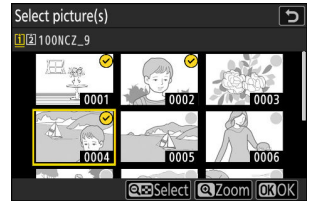

If you chose [Select date]:

- Highlight dates using the multi selector and press **▶** to select (☑) or deselect (☐).
- All pictures taken on dates marked with a check (☑) will be copied at the size selected in Step 2.
- Press **⊗** to proceed once selection is complete.

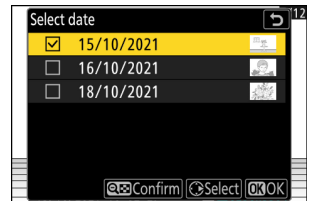

If you chose [Select folder]:

Highlight a folder and press **⊗** to select; all pictures in the selected folder will be copied at the size selected in Step 2.

6 Save the resized copies.

- A confirmation dialog will be displayed; highlight [Yes] and press **⊗** to save the resized copies.
- To cancel the operation before all copies have been created, press the **MENU** button; when a confirmation dialog is displayed, highlight [Yes] and press **⊗**.

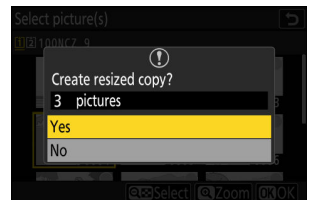

D-Lighting

D-Lighting brightens shadows. It is ideal for dark or backlit photographs.



Before



After

The effect is shown in the display. To view the unedited picture, press and hold the **DISP** button.

- Press or to choose the amount of correction performed. The effect can be previewed in the edit display.
- Press to save the retouched copy.

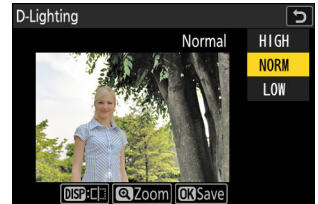

Straighten

Rotate pictures by up to $\pm 5^\circ$ in increments of approximately 0.25° .

- The effect can be previewed in the edit display. To view the unedited picture, press and hold the **DISP** button.
- The greater the rotation, the more will be trimmed from the edges.
- Press or to choose the amount of straightening performed.
- Press to save the retouched copy.

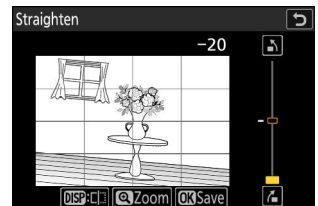

Distortion Control

Create copies with reduced peripheral distortion, reducing barrel distortion in pictures taken with wide-angle lenses or pincushion distortion in pictures taken with telephoto lenses.

- If the camera detects distortion, it will offer a choice of **[Auto]** and **[Manual]**. Select **[Auto]** to let the camera correct distortion automatically.
- If the camera is unable to detect distortion, the only option available will be **[Manual]**. Select **[Manual]** to reduce distortion manually.
- Note that **[Manual]** must be used with copies created using the **[Auto]** option and with photos taken using the **[Auto distortion control]** option in the photo shooting menu.
- When **[Manual]** is selected, the effect can be previewed in the display. To view the unedited picture, press and hold the **DISP** button.
- Press \odot to reduce pin-cushion distortion, \ominus to reduce barrel distortion. Press \odot to save changes and return to the previous display.
- Press \odot to save the retouched copy.

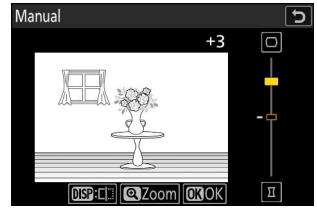











✓ Caution: Distortion Control

Note that greater amounts of distortion control result in more of the edges being cropped out.

Perspective Control

Create copies that reduce the horizontal and vertical effects of perspective in photos taken looking up from the base of a tall object.

- The effect can be previewed in the edit display. To view the unedited picture, press and hold the **DISP** button.
- Note that greater amounts of perspective control result in more of the edges being cropped out.
- For horizontal correction, highlight  and press . Press  to stretch the left edge,  to stretch the right. Press  to save changes and return to the previous display.
- For vertical correction, highlight  and press . Press  to stretch the top edge,  to stretch the bottom. Press  to save changes and return to the previous display.
- Press  to save the retouched copy.



Before





After

Monochrome

Copy photographs in a selected monochrome tint.

Option	Description
[Black-and-white]	Copy photographs in black-and-white.
[Sepia]	Copy photographs in sepia.
[Cyanotype]	Copy photographs in blue-and-white monochrome.

- The effect can be previewed in the edit display. To view the unedited picture, press and hold the **DISP** button.
- Highlighting [**Sepia**] or [**Cyanotype**] and pressing  displays saturation options for the selected monochrome tint; choose from [**High**], [**Normal**], and [**Low**]. Press  to save changes and return to the tint menu.
- Press  to save the retouched copy.

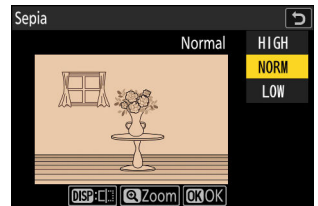

Overlay (Add)

Combine two existing photographs to create a single picture that is saved separately from the originals.



- 1 Select [Retouch] in the *i* menu, then highlight [Overlay (add)] and press \odot .

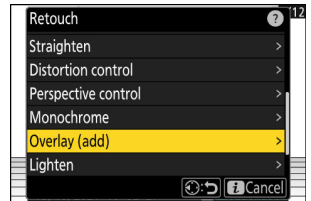

- 2 Select the pictures.

- Highlight pictures using the multi selector.
- To view the highlighted picture full screen, press and hold the \mathcal{Q} button.
- To select the highlighted picture, press the \mathcal{Q} (?) button. Selected pictures are marked with a check (\checkmark). To remove the check (\circ) and deselect the current picture, press the \mathcal{Q} (?) button again.
- Pictures with different image areas cannot be selected.
- Press \mathcal{O} to proceed once the second picture is selected.

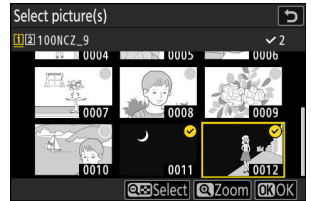

- 3 Adjust balance.

The overlay can be previewed in the display. Press \mathcal{O} or \mathcal{O} to adjust the balance between the two pictures. Press \mathcal{O} to make the first picture more visible and the second less, \mathcal{O} for the opposite effect.

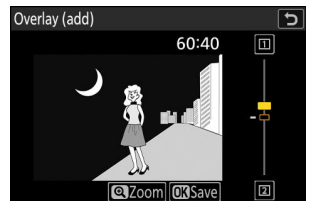

4 Save the overlay.

Press **OK** to save the overlay.



Cautions: [Overlay (Add)]

- Colors and brightness in the preview may differ from the final picture.
 - Only pictures created with this camera can be selected. Pictures created with other models cannot be selected.
 - The overlay will be the same size as the smallest of the two component pictures.
 - The overlay has the same photo info (including date of recording, metering, shutter speed, aperture, shooting mode, exposure compensation, focal length, and picture orientation) and values for white balance and Picture Control as the first of the two pictures selected. Copyright information, however, is not copied to the new picture. The comment is similarly not copied; instead, the comment currently active on the camera, if any, is appended.
-

“Lighten” and “Darken”

The camera compares multiple selected pictures and selects only the brightest or darkest pixels at each point in the picture to create a single new JPEG copy.

1 Select [Retouch] in the *i* menu, then highlight [Lighten] or [Darken] and press .

- [Lighten]: The camera compares the pixels in each picture and uses only the brightest.



- [Darken]: The camera compares the pixels in each picture and uses only the darkest.



2 Choose how pictures are selected.







Option	Description
[Select individual pictures]	Select pictures for the overlay one-by-one.
[Select consecutive pictures]	Select two pictures; the overlay will include the two pictures and all the pictures between them.
[Select folder]	The overlay will include all pictures in the selected folder.

3 Select the source slot.





- Highlight the slot with the card containing the desired pictures and press .
- You will not be prompted to select the slot if only one memory card is inserted.

4 Select the pictures.

If you chose [Select individual pictures]:

- Highlight pictures using the multi selector.
- To view the highlighted picture full screen, press and hold the .
- To select the highlighted picture, press the  (?). Selected pictures are marked with a check (). To remove the check () and deselect the current picture, press the  (?) button again. The selected pictures will be combined using the option selected in Step 1.
- Press  to proceed once selection is complete.

If you chose [Select consecutive pictures]:

- All pictures in a range chosen using the multi selector will be combined using the option selected in Step 1.
 - Use the  (?) button to select the first and last pictures in the desired range.
 - The first and last pictures are indicated by  icons and the pictures between them by  icons.
 - You can alter your selection by using the multi selector to highlight different pictures to serve as the first or last frame. Press the center of the sub-selector to choose the current picture as the new start or end point.
- To view the highlighted picture full screen, press and hold the .
- Press  to proceed once selection is complete.

If you chose [Select folder]:

Highlight the desired folder and press  to overlay all pictures in the folder using the option selected in Step 1.

5 Save the overlay.

- A confirmation dialog will be displayed; highlight [**Yes**] and press ⓧ to save the overlay and display the resulting picture.
- To interrupt the process and display a confirmation dialog before the operation is complete, press the MENU button; to save the current overlay “as is” without adding the remaining pictures, highlight [**Save and exit**] and press ⓧ. To exit without creating an overlay, highlight [**Discard and exit**] and press ⓧ.

✓ **Cautions: [Lighten]/[Darken]**

- Only pictures created with this camera can be selected. Pictures created with other models cannot be selected.
 - The overlay will include only pictures created with the same options selected for **[Image area]** > **[Choose image area]** in the photo shooting menu.
 - The image quality setting for the completed overlay is that of the highest quality picture it contains.
 - Overlays that include NEF (RAW) pictures will be saved at an image quality of **[JPEG fine★]**.
 - All JPEG pictures in the overlay must be the same size.
 - “Noise” (in the form of randomly-spaced bright pixels, fog, or lines) increases with the number of pictures in the overlay.
 - Noise will be less noticeable if the pictures for the overlay were shot with 0 or a negative value selected for the **[Sharpening]** Picture Control parameter.
 - Noise becomes noticeable in overlays that include around 50 pictures or more.
-

Motion Blend

The camera examines a selected burst of pictures to detect moving subjects and overlays them to create a single JPEG image.







- 1 Select [Retouch] in the *i* menu, then highlight [Motion blend] and press .



- 2 Select the source slot.

- Highlight the slot with the card containing the desired pictures and press .
- You will not be prompted to select the slot if only one memory card is inserted.

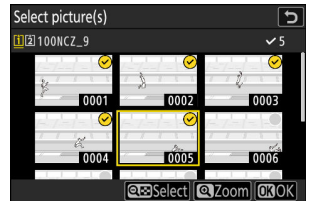

- 3 Select the pictures.

- Highlight pictures using the multi selector.
- To view the highlighted picture full screen, press and hold the  button.
- To select the highlighted picture, press the  (?). Selected pictures are marked with a check (). To remove the check () and deselect the current picture, press the  (?). button again.
- Motion blends can contain between 5 and 20 pictures.
- Press  to proceed once selection is complete.



- 4 Check the results.

Check the results of the overlay in the preview display.

- To return to Step 3 and choose different pictures, tap  or press .
- To proceed with the current selection, press ; a confirmation dialog will be displayed.

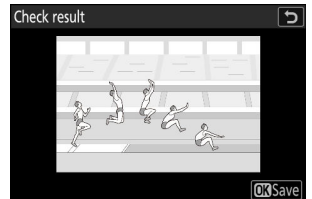

5 Save the overlay.

Highlight **[Yes]** in the confirmation dialog and press **Ⓜ** to save the overlay.

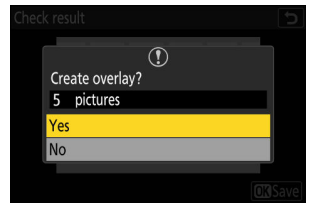



✔ Cautions: "Motion Blend"

- The final picture may differ from the preview both in how it looks (including color and brightness) and in how the pictures are combined.
 - Only pictures created with this camera can be selected. Pictures created with other models cannot be selected.
 - **[Motion blend]** is intended for bursts shot with the camera on a tripod, with a fixed background and moving subjects. The desired results may consequently not be achieved with bursts shot without a tripod.
 - The overlay will include only pictures created with the same options selected for **[Image area]** > **[Choose image area]** in the photo shooting menu.
 - The image quality setting for the completed overlay is that of the highest quality picture it contains.
 - Overlays that include NEF (RAW) pictures will be saved at an image quality of **[JPEG fine★]**.
 - All JPEG pictures in the overlay must be the same size.
-

Editing Videos

Videos can be edited using the following options:

Option	Description
 [Trim video]	Trim unwanted footage.
 [Save current frame]	Save a selected frame as a JPEG still.
 [Save consecutive frames]	Save the frames in a selected length of footage as a series of individual JPEG images.



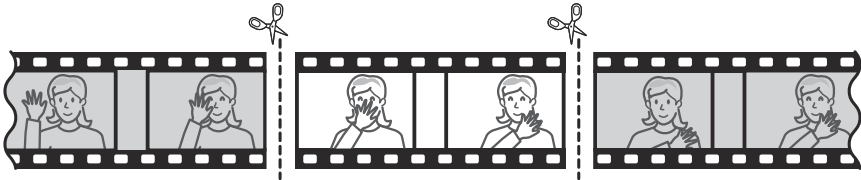

- These options are available only with videos recorded with [H.265 8-bit (MOV)] or [H.264 8-bit (MP4)] selected for [Video file type] in the video recording menu.

Trimming Videos



1 Display a video full frame.

2 Pause the video on the new opening frame.

- Press  to start playback. Press  to pause.
- Your approximate position in the video can be ascertained from the video progress bar.
- Press  or  or rotate the command dials to locate the desired frame.

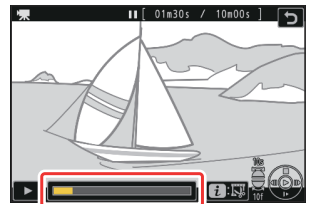

3 Press the *i* button, highlight [Trim video], and press \triangleright .

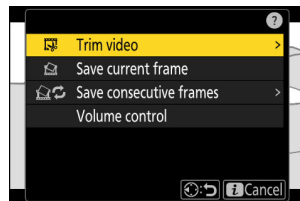

4 Choose the start point.

To create a copy that begins from the current frame, highlight [Start point] and press \otimes .

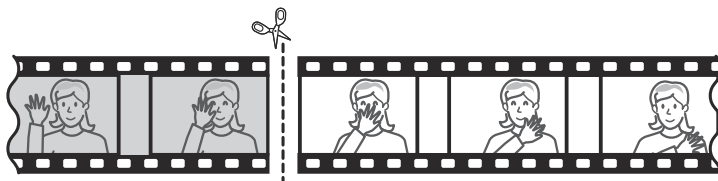
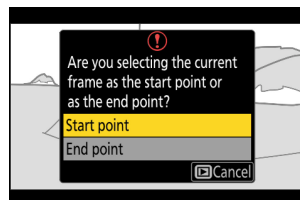

5 Confirm the new start point.

- If the desired frame is not currently displayed, press \leftarrow or \rightarrow to advance or rewind a frame at a time.
- Rotate the main command dial one stop to skip ahead or back 10 frames.
- Rotate the sub-command dial one stop to skip ahead or back 10 s.

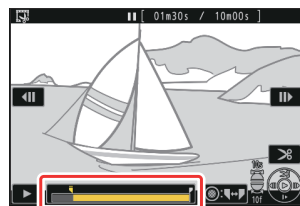

6 Choose the end point.

Press the center of the sub-selector to switch to the end-point selection tool (P) and then select the closing frame (P) as described in Step 5.

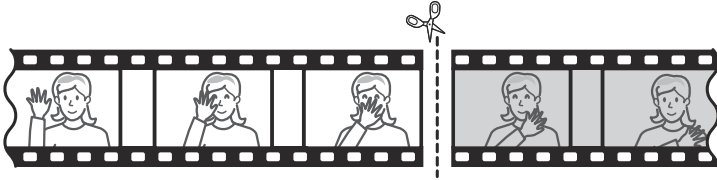
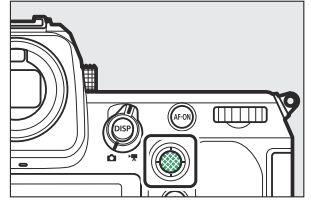

7 Press ⌘ to create the copy.

8 Preview the copy.

- To preview the copy, highlight [**Preview**] and press ⌘ (to interrupt the preview and return to the save options menu, press ⌘).
- To abandon the current copy and return to Step 5, highlight [**Cancel**] and press ⌘.

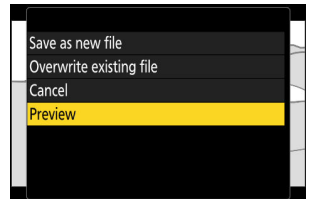

9 Choose a save option.

Choose [**Save as new file**] to save the edited copy as a new file. To replace the original video with the edited copy, choose [**Overwrite existing file**].

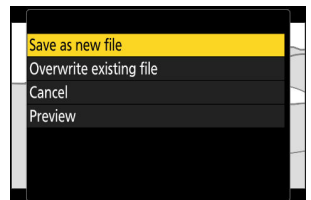

10 Save the copy.

Press ⌘ to save the copy.

✓ **Cautions: Trimming Videos**

- The copy will not be saved if there is insufficient space available on the memory card.
 - Videos less than two seconds long cannot be edited using **[Trim video]**.
 - Copies have the same time and date of creation as the original.
-

Tip: Removing Opening or Closing Footage

- To remove only the closing footage from a video, highlight **[End point]** and press Ⓢ in Step 4, select the closing frame, and proceed to Step 7 without pressing the center of sub-selector in Step 6.
- To remove only the opening footage, proceed to Step 7 without pressing the center of sub-selector in Step 6.

Tip: The **i Menu **[Trim Video]** Option**



Videos can also be edited using the **[Trim video]** item in the **i** menu.

Saving Selected Frames as JPEG Stills

Stills can be created from individual frames of existing videos. You can create a single still from the current frame or a series of stills from a selected length of footage.

Saving the Current Frame as a JPEG Still

1 Pause the video on the desired frame.

- Press  to pause playback.
- Your approximate position in the video can be ascertained from the video progress bar.
- Press  or  or rotate the command dials to locate the desired frame.



2 Press the **i** button and highlight [Save current frame].

Press  to create a JPEG copy of the current frame.

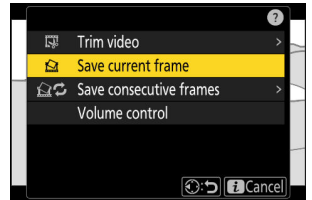

[Save Current Frame]

- Stills are saved at the dimensions selected for [**Frame size/frame rate**] in the video recording menu when the video was recorded.
 - They cannot be retouched.
-

Creating Stills from a Selected Length of Footage

1 Pause the video on the desired frame.

- Press **⏸** to pause playback.
- Your approximate position in the video can be ascertained from the video progress bar.
- Press **⏮** or **⏭** or rotate the command dials to locate the desired frame.

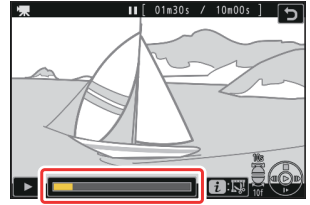

2 Press the **i** button, highlight [Save consecutive frames] and press **⏭**.

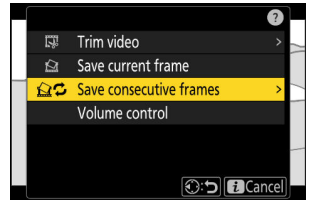

3 Choose a destination.

- Choose the destination.
- Press **⏮** or **⏭** to highlight a card slot and press **Ⓜ**.
- You will not be prompted to select the slot if only one memory card is inserted.



4 Choose the length of footage.

Choose the length of footage that will be saved as stills.



5 Press **Ⓜ**.

The selected footage will be saved as a series of JPEG stills. The number varies with the video frame rate.

“Save Consecutive Frames”

- Stills are saved at the dimensions selected for [**Frame size/frame rate**] in the video recording menu when the video was recorded.
 - They cannot be retouched.
-

Voice Memos

Recording Voice Memos

Voice memos up to 60 seconds long can be added to photographs.

1 Select the photograph.

Only one voice memo can be recorded per picture; additional voice memos cannot be recorded for pictures already marked with a  icon. The existing voice memo must be deleted before another can be recorded ([link 294](#)).

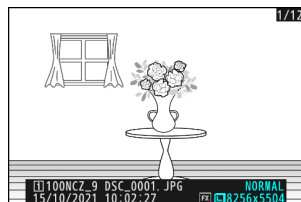

2 Hold the button.

- Audio is recorded while the button is pressed.
- During recording, the camera displays a  icon and a countdown of the remaining recording time, in seconds.

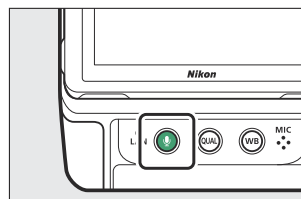

3 Release the button.

- Recording will end.
- Pictures with voice memos are indicated by  icons.

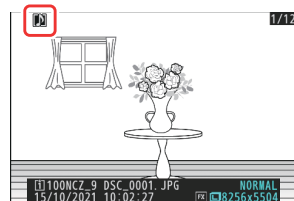

✔ Recording Not Available

Voice memos cannot be added to videos or Image Dust Off reference data.

✔ Recording Restrictions

Voice memos cannot be recorded if:

- the photo/video selector is rotated to  or
- a multiple exposure is in progress.

✔ Caution: Recording Voice Memos

Touch controls are disabled and other pictures cannot be displayed while recording is in progress.

✔ Interrupting Recording

Pressing the shutter-release button or operating other camera controls may end recording. During interval-timer photography, recording ends about two seconds before the next shot is taken; recording also ends when the camera is turned off.

✔ Storage Location

Voice memos for pictures taken with two memory cards inserted and [Backup], [RAW Slot 1 - JPEG Slot 2], or [JPEG Slot 1 - JPEG Slot 2] selected for [Role played by card in Slot 2] in the photo shooting menu are recorded with the copies on both cards.

✔ Voice Memo File Names



Voice memo file names have the form "DSC_nnnn.WAV". The voice memo has the same file number ("nnnn") as the picture with which it is associated. For example, the voice memo for the picture "DSC_0002.JPG" would have the file name "DSC_0002.WAV". Voice memo file names can be viewed on a computer.

- Voice memos for photos recorded with [Adobe RGB] selected for [Color space] in the photo shooting menu have names of the form "_DSCnnnn.WAV".
- Voice memos for photos recorded with a prefix other than "DSC" selected for [File naming] in the photo shooting menu will be recorded with the selected prefix in place of "DSC".

Tip: The **i** Menu

Recording can also be initiated by highlighting [Record voice memo] in the playback **i** menu and pressing . To end recording, press  a second time.

Playing Voice Memos

To play voice memos, press the  button when viewing photographs marked with  icons.

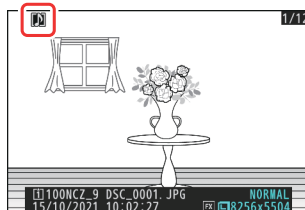



Interrupting Playback





Pressing the shutter-release button or operating other camera controls may end playback. Playback ends automatically when another picture is selected or the camera is turned off.

Tip: The **i** Menu

Voice memos can also be played by highlighting [**Play voice memo**] in the playback **i** menu and pressing .

Deleting Voice Memos

To delete the voice memo from the current photo, press the  () button; a confirmation dialog will be displayed as shown.

- To delete both the photo and the voice memo, highlight [**Picture and voice memo**] and press  (.
- To delete only the voice memo, highlight [**Voice memo only**] and press  (.
- To exit without deleting either the photo or the voice memo, press .
- With dual-format pictures, you may opt to delete the voice memo only from the picture on the card in the current slot by choosing [**Selected picture**] in the confirmation dialog and then selecting [**Voice memo only**].

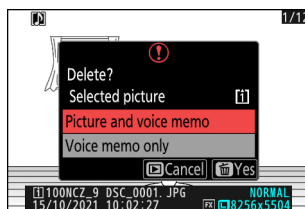

Connecting to HDMI TVs and Recorders

Connecting to HDMI Devices

The camera can be connected to TVs, recorders, and other devices featuring HDMI connectors. Use a third-party type A HDMI cable. The cable must be purchased separately. Always turn the camera off before connecting or disconnecting a cable.

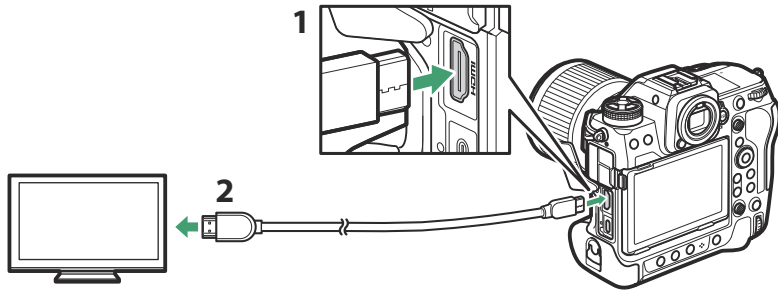

- 1 HDMI connector for connection to camera
- 2 HDMI connector for connection to external device *

* Choose a cable with a connector that matches the connector on the HDMI device.

TVs

- After tuning the TV to the HDMI input channel, turn the camera on and press the  button to view pictures on the television screen.
- Audio playback volume can be adjusted using the controls on the TV. Camera controls cannot be used.
- If the camera is paired with a smart device running the SnapBridge app, the device can be used to control playback remotely while the camera is connected to a TV. See SnapBridge online help for details.
- Use an HDMI input connector compliant with HDMI 2.1 to connect to televisions that support 8K input.

Recorders

In video mode, the camera can record directly to connected HDMI recorders.

- If a memory card is inserted in the camera when it is connected to a recorder, video will be recorded both to the recorder and the memory card. If no memory card is inserted, the footage will be recorded only to the external device.

Adjusting Settings

Use the **[HDMI]** item in the setup menu to adjust settings for HDMI output.

Option	Description
[Output resolution]	<p>The format for output to HDMI devices can be selected from [Auto], [4320p (progressive)], [2160p (progressive)], [1080p (progressive)], [1080i (interlaced)], and [720p (progressive)].</p> <ul style="list-style-type: none">• Video will not be output at 1080i when [Auto] is selected for [Output resolution] even when a recorder that supports this option is connected. Choose [1080i (interlaced)] for interlaced output.
[Output range]	<p>The RGB video signal input range varies with the HDMI device. [Auto], which matches the output range to the HDMI device, is recommended in most situations. If the camera is unable to determine the correct RGB video signal output range for the HDMI device, you can choose from the following options:</p> <ul style="list-style-type: none">• [Limited range]: For devices with an RGB video signal input range of 16 to 235. Choose this option if you notice a loss of detail in shadows.• [Full range]: For devices with an RGB video signal input range of 0 to 255. Choose this option if you notice that shadows are “washed out” or too bright.
[Output shooting info]	<p>Choose whether shooting information is displayed on the HDMI device. If [ON] is selected, icons and other information in the shooting display will be recorded with the footage saved to external recorders.</p>

Option	Description
[Mirror camera info display]	<p>Choose whether the display in the camera monitor remains on while an HDMI device is connected.</p> <ul style="list-style-type: none"> • If [OFF] is selected, the display will remain off, reducing the drain on the camera battery. • [Mirror camera info display] will be fixed at [ON] while [OFF] is selected for [Output shooting info].

“Output Resolution”

- When **[Auto]** is selected for **[HDMI] > [Output resolution]** in the setup menu, the camera automatically detects whether the external recorder supports the frame size and rate selected on the camera. If it does not, the camera will search for a supported resolution and frame rate in the order listed below. If no supported resolution and frame rate is found, output will be suspended.

- No memory card inserted in camera:

Frame size/frame rate	Output resolution/frame rate search order
[7680×4320; 30p]	4320/30p → 2160/30p → 1080/30p
[7680×4320; 25p]	4320/25p → 2160/25p → 1080/25p
[7680×4320; 24p]	4320/24p → 2160/24p → 1080/24p
[3840×2160; 120p]	2160/120p → 1080/120p → 2160/60p → 1080/60p → 2160/30p → 1080/30p
[3840×2160; 100p]	2160/100p → 1080/100p → 2160/50p → 1080/50p → 2160/25p → 1080/25p
[3840×2160; 60p]	2160/60p → 1080/60p → 2160/30p → 1080/30p
[3840×2160; 50p]	2160/50p → 1080/50p → 2160/25p → 1080/25p
[3840×2160; 30p]	2160/30p → 1080/30p
[3840×2160; 25p]	2160/25p → 1080/25p
[3840×2160; 24p]	2160/24p → 1080/24p

Frame size/frame rate	Output resolution/frame rate search order
[1920×1080; 120p]	1080/120p → 1080/60p → 1080/30p
[1920×1080; 100p]	1080/100p → 1080/50p → 1080/25p
[1920×1080; 60p]	1080/60p → 1080/30p
[1920×1080; 50p]	1080/50p → 1080/25p
[1920×1080; 30p]	1080/30p
[1920×1080; 25p]	1080/25p
[1920×1080; 24p]	1080/24p

- **Memory card inserted in camera:**

Frame size/frame rate	Output resolution/frame rate search order
[7680×4320; 30p]	1080/30p
[7680×4320; 25p]	1080/25p
[7680×4320; 24p]	1080/24p
[3840×2160; 120p]	1080/60p → 1080/30p
[3840×2160; 100p]	1080/50p → 1080/25p
[3840×2160; 60p] – [1920×1080; 24p]	Same as when no memory card is inserted in the camera.

- When an option other than **[Auto]** is selected for **[Output resolution]**, the signal will be output at the selected resolution. HDMI output will be suspended if:
 - output resolution is higher than the current frame size or
 - the recorder does not support the selected output resolution.
- Regardless of the option chosen for **[HDMI] > [Output resolution]** in the setup menu, the maximum output resolution when **[N-RAW 12-bit (NEV)]** or **[ProRes RAW HQ 12-bit (MOV)]** is selected for **[Video file type]** in the video recording menu is 1920 × 1080.

✔ **Frame Rates for [Output Resolution] Options Other Than [Auto]**

Video recording rates of 120p, 100p, 60p, or 50p will be adjusted as follows if not compatible with the frame rate chosen for the external recorder.

- 120p: The frame rate will first drop to 60p. If 60p is also not supported, it will drop to 30p.
- 100p: The frame rate will first drop to 50p. If 50p is also not supported, it will drop to 25p.
- 60p: The frame rate will drop to 30p.
- 50p: The frame rate will drop to 25p.

✔ **Frame Rates for an [Output Resolution] of [720p (progressive)]**

Footage filmed at a frame rate of 120p, 60p, 30p, or 24p is output at 60p. Footage filmed at 100p, 50p, or 25p is output at 50p.



✔ **Frame Rates for an [Output Resolution] of [1080i (interlaced)]**

Footage filmed at a frame rate of 120p, 60p, 30p, or 24p is output at 60i. Footage filmed at 100p, 50p, or 25p is output at 50i.

✔ **Caution: Filming with Memory Cards**

Footage filmed at a frame size of 7680 × 4320 or at a frame size and rate of 3840 × 2160; 120p or 3840 × 2160; 100p will not be output via HDMI if **[4320p (progressive)]** or **[2160p (progressive)]** is selected for **[HDMI] > [Output resolution]** in the setup menu. Remove the memory cards from the camera and record the footage to the external recorder.

✔ **Zoom**

- The camera display can be zoomed in by pressing the  button during recording, but this has no effect on the footage output to the recorder.
 - If no footage is currently being recorded, changes to zoom using the  button will be reflected both in the camera display and in the output to the recorder. The output resolution however switches to **[1080p (progressive)]**, even if the option last selected for **[HDMI] > [Output resolution]** in the setup menu was **[4320p (progressive)]** or **[2160p (progressive)]**.
-

YCbCr and Bit Depth

The YCbCr value and bit depth for footage output to external HDMI devices varies with the options selected for **[Video file type]** and **[Frame size/frame rate]** in the video recording menu.

Video file type	Frame size/frame rate	YCbCr and bit depth
N-RAW 12-bit (NEV)	8256×4644	<ul style="list-style-type: none"> • Video mode (ready to record/recording in progress): 4:2:2 10-bit • Video playback: 4:2:2 8-bit
	4128×2322	
	5392×3032	
	3840×2160	
ProRes RAW HQ 12-bit (MOV)	4128×2322	<ul style="list-style-type: none"> • Video mode (ready to record/recording in progress): 4:2:2 10-bit • Video playback: 4:2:2 8-bit
	5392×3032	
	3840×2160	
ProRes 422 HQ 10-bit (MOV)	3840×2160	4:2:2 10-bit
	1920×1080	
H.265 10-bit (MOV)	7680×4320	4:2:0 10-bit
	3840×2160 120p/100p	
	3840×2160 60p/50p/30p/25p/24p	4:2:2 10-bit
	1920×1080	
H.265 8-bit (MOV)	7680×4320	4:2:0 8-bit
	3840×2160 120p/100p	
	3840×2160 60p/50p/30p/25p/24p	4:2:2 8-bit
	1920×1080	

Video file type	Frame size/frame rate	YCbCr and bit depth
H.264 8-bit (MP4)	1920×1080	4:2:2 8-bit

Recording to External Recorders That Support a Bit Depth of 10 Bits



The HDMI signal will be output at a bit depth of 10 bits only to HDMI recorders that support this option.

HDMI Output and Tone Mode

The tone mode selected via [**Video file type**] in the video recording menu applies to video output via HDMI. Equipment that supports HDR (HLG) is required when [**HLG**] is selected.

External Recording Control

Choosing **[ON]** for **[External rec. cntrl (HDMI)]** in the video recording menu allows camera controls to be used to start and stop recording on the external recorder.

- For information on whether your recorder supports external recording control, consult the manufacturer.
- The camera display will turn off automatically when the time selected for Custom Setting c3 **[Power off delay]** > **[Standby timer]** expires, ending HDMI output. When recording videos to an external device, select **[Standby timer]** and choose **[No limit]** or a time longer than the anticipated recording time.
- An icon will be displayed in the camera monitor when **[ON]** is selected:  is displayed if no footage is currently being recorded,  while videos are being recorded. During recording, check the recorder and recorder display to ensure that footage is being saved to the device.
- Note that selecting **[ON]** may disrupt the footage output to the device.

Connecting to Smart Devices

The SnapBridge App

Use the SnapBridge app for wireless connections between the camera and your smartphone or tablet ("smart device").



- SnapBridge apps can be downloaded from the Apple App Store® or on Google Play™.
- Visit the Nikon website for the latest SnapBridge news.



- Carefully read any license agreements or the like displayed when SnapBridge is launched and only proceed if you are willing to accept them.

What SnapBridge Can Do for You

The tasks that can be performed using the SnapBridge app are outlined below. For details, see the SnapBridge app online help:

<https://nikonimglib.com/snbr/onlinehelp/en/index.html>

■ Downloading Pictures from the Camera

Download existing pictures to your smart device. They can also be downloaded automatically as they are taken.

■ Remote Photography

Control the camera and take pictures from the smart device.

Can't Connect?

If you have trouble establishing a connection with the smart device, try:

- turning the camera and smart device off and then on again, or
 - checking wireless settings on the smart device.
-

Wireless Connections

Use the SnapBridge app for wireless connections between the camera and your smart device. You can connect via either Bluetooth ([📖 306](#)) or Wi-Fi ([📖 310](#)). Connecting using Bluetooth allows pictures to be uploaded automatically as they are taken.

Connecting via Bluetooth (Pairing)

Before connecting via Bluetooth for the first time, you will need to pair the camera and smart device.

✔ Before Pairing

- Enable Bluetooth on the smart device. For details, see the documentation provided with the device.
- Ensure that the batteries in the camera and smart device are fully charged to prevent the devices turning off unexpectedly.
- Check that there is space available on the camera memory card.

Pairing

Pair the camera and smart device as described below.

- Some operations are performed using the camera, others on the smart device.
- Additional instructions are available via SnapBridge online help.

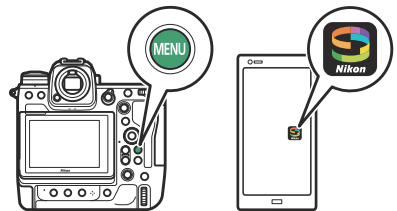

- 1 Camera:** Select [Connect to smart device] > [Pairing (Bluetooth)] in the network menu, then highlight [Start pairing] and press **⌘**.

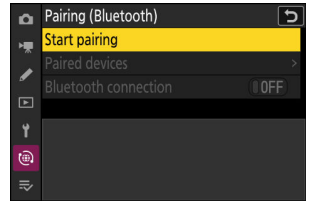

The camera name will be displayed in the monitor.

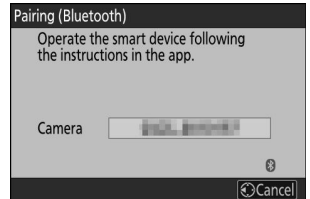

- 2 Smart device:** Launch the SnapBridge app and tap [Connect to camera] in the  tab.

If this is the first time you have launched the app, you should instead tap [Connect to camera] in the welcome display.

- 3 Smart device:** Follow the on-screen instructions.

- When prompted, tap the category for your camera and then tap the “pairing” option when prompted to choose the connection type.
- Tap the camera name when prompted.

4 Camera/smart device: After confirming that the camera and smart device display the same authentication code, follow the on-screen instructions on both devices to complete pairing.

- Tap the pairing button on the smart device and press the Ⓜ button on the camera.
- The camera and smart device will each display a message when pairing is complete. The camera will then automatically exit to the menu.

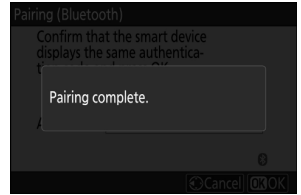

The camera and smart device are now paired.

For information on using the SnapBridge app, see online help.

✔ Pairing Error

If you wait too long between pressing the button on the camera and tapping the button on the smart device in Step 4, the device will display an error message and pairing will fail.

- If you are using an Android device, tap **[OK]** and return to Step 1.
- If you are using an iOS device, dismiss the SnapBridge app and check that it is not running in the background, then request iOS to “forget” the camera before returning to Step 1. The request to “forget” the camera is made via the iOS “Settings” app.



✔ Disabling Bluetooth

To disable Bluetooth, select **[OFF]** for **[Connect to smart device] > [Pairing (Bluetooth)] > [Bluetooth connection]** in the camera network menu.

Connecting to a Previously-Paired Smart Device

Once the smart device has been paired with the camera, you will be able to connect simply by enabling Bluetooth on both the smart device and camera and launching the SnapBridge app.

Connecting via Wi-Fi (Wi-Fi Mode)

In Wi-Fi mode, the camera connects directly to the smart device via Wi-Fi, no Bluetooth pairing required.

✓ Before Connecting (Wi-Fi Mode)

- Enable Wi-Fi on the smart device. For details, see the documentation provided with the device.
- Ensure that the batteries in the camera and smart device are fully charged to prevent the devices turning off unexpectedly.
- Check that there is space available on the camera memory card.

Connecting

Follow the steps below to establish a connection between the camera and smart device in Wi-Fi mode.

- Some operations are performed using the camera, others on the smart device.
- Additional instructions are available via SnapBridge online help.

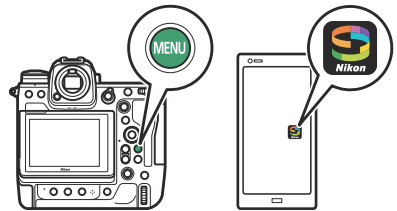

1 Smart device: Launch the SnapBridge app, open the tab, tap , and select [Wi-Fi mode].

If this is the first time you have launched the app, you should instead tap **[Connect to camera]** in the welcome display. When prompted, tap the category for your camera and then tap the “Wi-Fi” option when prompted to choose the connection type.

2 Camera/smart device: Turn the camera on when prompted.

Do not use any of the controls in the app at this point.

- 3 Camera:** Select [Connect to smart device] > [Wi-Fi connection] in the network menu, then highlight [Establish Wi-Fi connection] and press **⌘**.

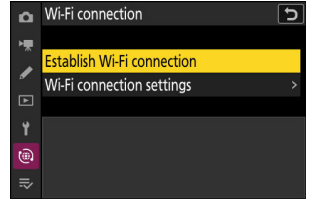

The camera SSID and password will be displayed.



4 Smart device: Follow the on-screen instructions to establish a Wi-Fi connection.

- On iOS devices, the "Settings" app will launch. Tap [**< Settings**] to open [**Settings**], then scroll up and tap [**Wi-Fi**] (which you'll find near the top of the settings list) to display Wi-Fi settings.

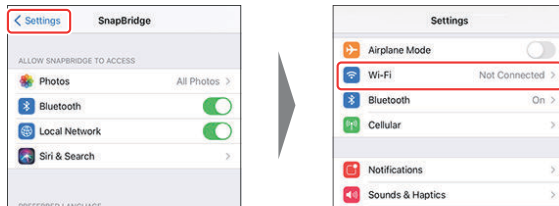

- In the Wi-Fi settings display, select the camera SSID and enter the password displayed by the camera in Step 3.

5 Smart device: After adjusting device settings as described in Step 4, return to the SnapBridge app.



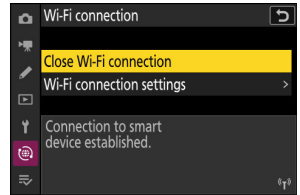

- After establishing a Wi-Fi connection to the camera, the smart device will display Wi-Fi mode options.
- The camera will display a message stating that the connection is complete.



The camera and smart device are now connected via Wi-Fi.

For information on using the SnapBridge app, see online help.

✓ Terminating Wi-Fi Mode

To end the Wi-Fi connection, tap  in the SnapBridge  tab. When the icon changes to , tap  and select **[Exit Wi-Fi mode.]**

Connecting to Computers or FTP Servers

Making the Connection

The camera can be connected to a computer or FTP server using any of the methods below.

Computers: Connecting via USB

Connect the camera and computer via USB and use NX Studio to upload pictures to the computer ([316](#)).

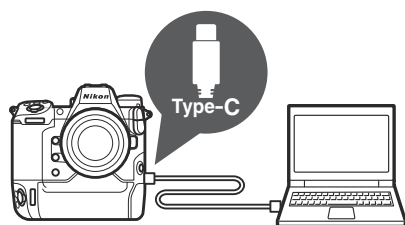

- You can also control the camera remotely using Camera Control Pro 2 (available separately) or free NX Tether software.

Computers: Connecting via Ethernet or Wireless LAN

Connect to a computer via Ethernet or using the camera's built-in wireless LAN. You can upload pictures to the computer or control the camera remotely via a network using Camera Control Pro 2 (available separately) or free NX Tether ([📄 320](#)).

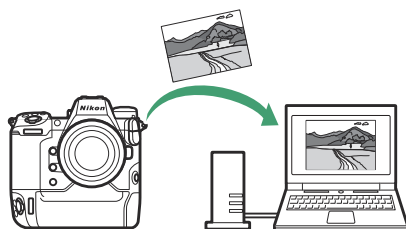

FTP Servers: Connecting via Ethernet or Wireless LAN

Upload pictures to an FTP server via Ethernet or using the camera's built-in wireless LAN ([350](#)).

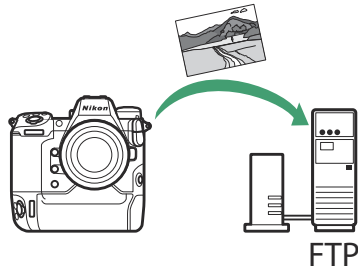

Can't Connect?

If you have trouble establishing a connection with a computer or FTP server, try:

- turning the camera off and then on again,
- checking wireless settings on the computer or FTP server, or
- restarting the computer or FTP server.

Tip: Wireless LAN and Ethernet Errors

For information on wireless- or Ethernet-related errors, see "Troubleshooting Wireless LAN and Ethernet Connections" ([382](#)).

Computers: Connecting via USB

Connect the camera using the supplied USB cable. You can then use NX Studio software to copy pictures to the computer for viewing and editing.

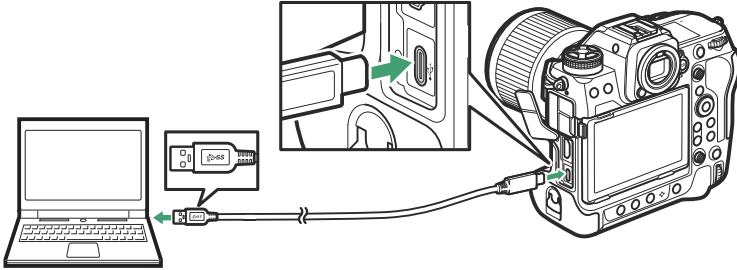

Installing NX Studio

You will need an Internet connection when installing NX Studio. Visit the Nikon website for the latest information, including system requirements.

- Download the latest NX Studio installer from the website below and follow the on-screen instructions to complete installation.
<https://downloadcenter.nikonimglib.com/>
- Note that you may be unable to download pictures from the camera using earlier versions of NX Studio.

Copying Pictures to a Computer Using NX Studio

See online help for detailed instructions.

1 Connect the camera to the computer.

After turning the camera off and ensuring that a memory card is inserted, connect the supplied USB cable as shown.

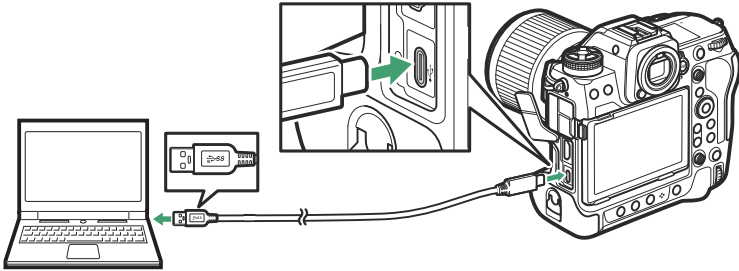

Tip: Using a Card Reader

Pictures can also be copied from a memory card inserted in a third-party card reader. You should however check that the card is compatible with the card reader.

2 Turn the camera on.

- The Nikon Transfer 2 component of NX Studio will start. Nikon Transfer 2 image transfer software is installed as part of NX Studio.
- If a message is displayed prompting you to choose a program, select Nikon Transfer 2.
- If Nikon Transfer 2 does not start automatically, launch NX Studio and click the "Import" icon.

3 Click [Start Transfer].

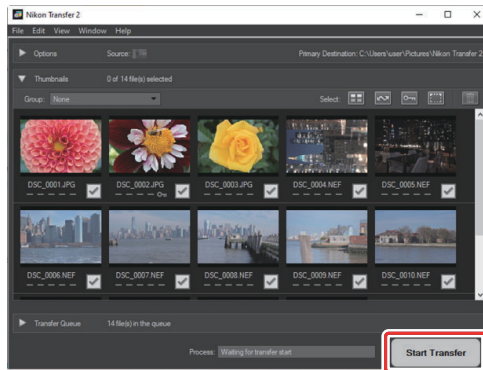

Pictures on the memory card will be copied to the computer.

4 Turn the camera off.

Disconnect the USB cable when transfer is complete.

✓ Windows

Some computers may be configured to display an AutoPlay prompt when the camera is connected.

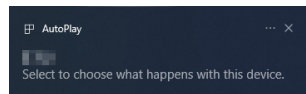

Click the dialog and then click **[Nikon Transfer 2]** to select Nikon Transfer 2.

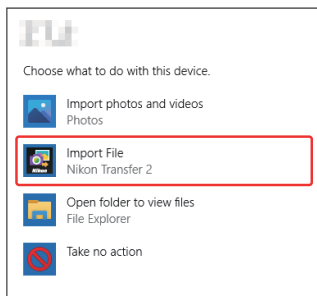

✓ macOS

If Nikon Transfer 2 does not start automatically, confirm that the camera is connected and then launch Image Capture (an application that comes with macOS) and select Nikon Transfer 2 as the application that opens when the camera is detected.

✓ Caution: Transferring Videos

Do not attempt to transfer videos from the memory card while it is inserted in a camera of a different make or model. Doing so could result in the videos being deleted without being transferred.

✓ Cautions: Connecting to Computers

- Do not turn the camera off or disconnect the USB cable while transfer is in progress.
- Do not use force or attempt to insert the connectors at an angle. Be sure also to keep the connectors straight when disconnecting the cable.
- Always turn the camera off before connecting or disconnecting a cable.
- To ensure that data transfer is not interrupted, be sure the camera battery is fully charged.

✓ USB Hubs

Connect the camera directly to the computer; do not connect the cable via a USB hub or keyboard. Connect the camera to a pre-installed USB port.

Computers: Connecting via Ethernet or Wireless LAN

The camera can connect to computers either directly or via existing networks using Wi-Fi (built-in wireless LAN) or a third-party Ethernet cable inserted in the camera's Ethernet connector.

What Ethernet and Wireless LAN Can Do for You

Ethernet and wireless LAN connections can be used for the following tasks:

■ **Uploading Pictures**

Existing pictures can be uploaded to the computer. They can also be uploaded automatically as they are taken.

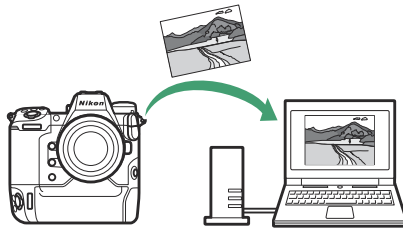

Controlling Cameras Remotely

Installing Camera Control Pro 2 (available separately) or free NX Tether software on a networked computer gives you control over the details of exposure and other camera settings while taking pictures remotely ([book 346](#)).

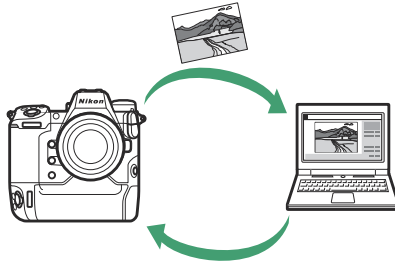

The Wireless Transmitter Utility

Before you will be able to connect to a wireless or Ethernet LAN, you will need to pair the camera with the computer using Nikon's Wireless Transmitter Utility software.

- Once the devices are paired, you will be able to connect to the computer from the camera.
- The Wireless Transmitter Utility is available for download from the Nikon Download Center. Check the version and system requirements and be sure to download the latest version.

<https://downloadcenter.nikonimglib.com/>

Wireless LAN

The camera can connect to computers either by direct wireless link (access-point mode) or via a wireless router on an existing network, including home networks (infrastructure mode).

Direct Wireless Connection (Access-Point Mode)

The camera and computer connect via direct wireless link. The camera acts as a wireless LAN access point, letting you connect when working outdoors and in other situations in which the computer is not already connected to a wireless network and eliminating the need for complicated adjustments to settings. The computer cannot connect to the Internet while connected to the camera.

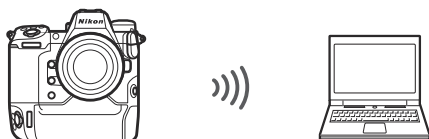

- Before proceeding, check that the Wireless Transmitter Utility ([book 321](#)) is installed on the computer.
- Confirm that **[OFF]** is selected for **[Wired LAN]** in the network menu.

- 1 Select [Connect to computer] in the network menu, then highlight [Network settings] and press \odot .**

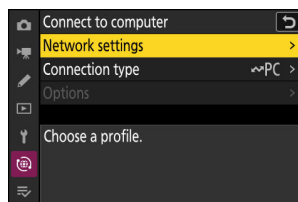

- 2 Highlight [Create profile] and press \odot .**

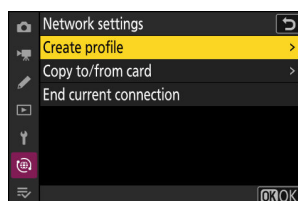

3 Name the new profile.

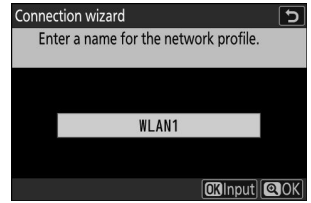

- To proceed to the next step without changing the default name, press **↵**.
- Whatever name you choose will appear in the network menu [**Connect to computer**] > [**Network settings**] list.
- To rename the profile, press **ⓧ**. For information on text entry, see “Text Entry” ([📖 71](#)). Press **↵** to proceed after entering a name.

4 Highlight [**Direct connection to computer**] and press **ⓧ**.

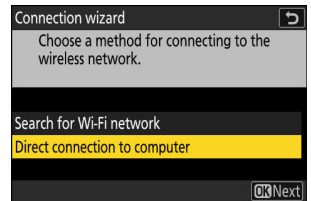

The camera SSID and encryption key will be displayed.

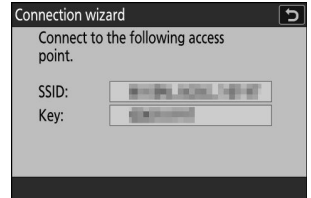

5 Establish a connection to the camera.

Windows:

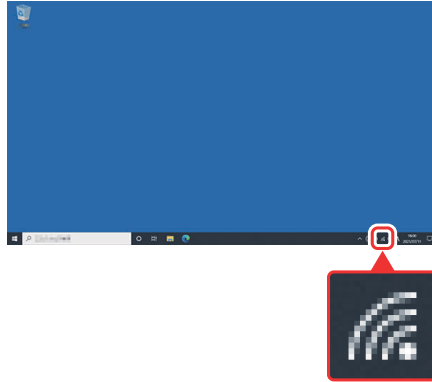

- Click the wireless LAN icon in the taskbar.
- Select the SSID displayed by the camera in Step 4.
- When prompted to enter the network security key, enter the encryption key displayed by the camera in Step 4. The computer will initiate a connection to the camera.

macOS:

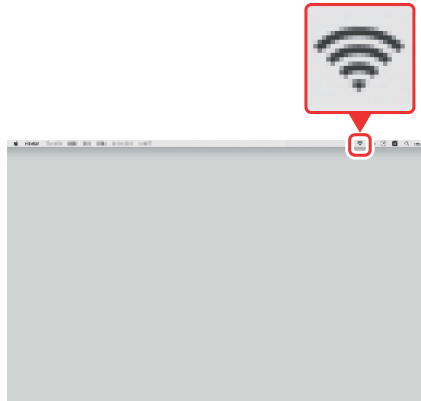

- Click the wireless LAN icon in the menu bar.
- Select the SSID displayed by the camera in Step 4.
- When prompted to enter the network security key, enter the encryption key displayed by the camera in Step 4. The computer will initiate a connection to the camera.

6 Start pairing.

When prompted, launch the Wireless Transmitter Utility on the computer.

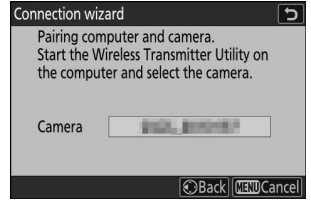

7 Select the camera in the Wireless Transmitter Utility.

Select the name displayed by the camera in Step 6 and click **[Next]**.

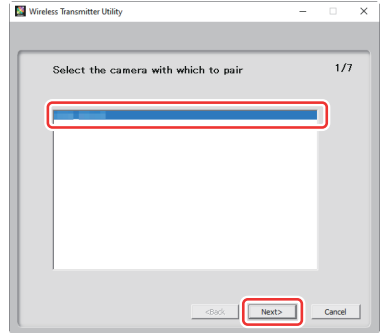

8 In the Wireless Transmitter Utility, enter the authentication code displayed by the camera.

- The camera will display an authentication code.



- Enter the authentication code in the dialog displayed by the Wireless Transmitter Utility and click **[Next]**.

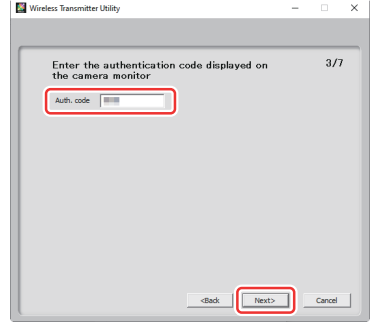

9 Complete the pairing process.

- When the camera displays a message stating that pairing is complete, press **[OK]**.

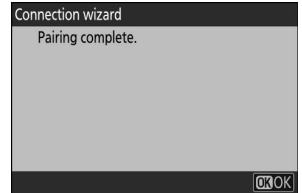

- In the Wireless Transmitter Utility, click **[Next]**; you will be prompted to choose a destination folder. For more information, see online help for the Wireless Transmitter Utility.

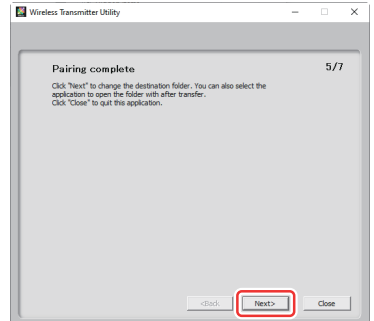

- A wireless connection will be established between the camera and computer when pairing is complete.

10 Check the connection.

When a connection is established, the profile name will be displayed in green in the camera [Connect to computer] menu.

- If the profile name is not displayed in green, connect to the camera via the wireless network list on your computer.

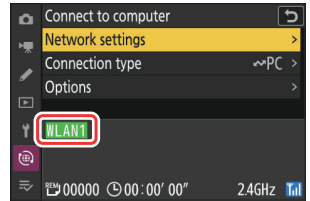

A wireless connection has now been established between the camera and the computer.

Pictures taken with the camera can be uploaded to the computer as described in “Uploading Pictures” ([📖 340](#)).

For information on controlling the camera from a computer using Camera Control Pro 2 or NX Tether, see “Camera Control” ([📖 346](#)).

Connecting in Infrastructure Mode

The camera connects to a computer on an existing network (including home networks) via a wireless router. The computer can still connect to the Internet while connected to the camera.

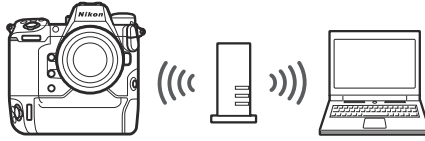

- Before proceeding, check that the Wireless Transmitter Utility ([link 321](#)) is installed on the computer.
- Confirm that **[OFF]** is selected for **[Wired LAN]** in the network menu.

Infrastructure Mode

Connection to computers beyond the local area network is not supported. You can connect only to computers on the same network.

- 1** Select **[Connect to computer]** in the network menu, then highlight **[Network settings]** and press **[OK]**.

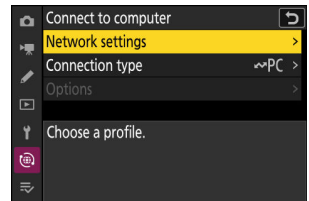

- 2** Highlight **[Create profile]** and press **[OK]**.

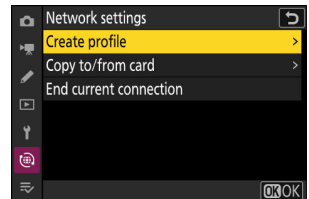

3 Name the new profile.

- To proceed to the next step without changing the default name, press **Q**.
- Whatever name you choose will appear in the network menu **[Connect to computer] > [Network settings]** list.
- To rename the profile, press **⌘**. For information on text entry, see “Text Entry” ([71](#)). Press **Q** to proceed after entering a name.

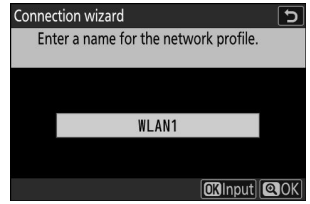

4 Highlight **[Search for Wi-Fi network]** and press **⌘**.

The camera will search for networks currently active in the vicinity and list them by name (SSID).



✓ [Easy Connect]

- To connect without entering an SSID or encryption key, press **Q** in Step 4. Next, press **⌘** and choose from the following options:

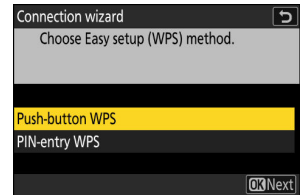

Option	Description
[Push-button WPS]	For routers that support push-button WPS. Press the WPS button on the router and then press the camera ⌘ button to connect.
[PIN-entry WPS]	The camera will display a PIN. Using a computer, enter the PIN on the router. For more information, see the documentation provided with the router.

- After connecting, proceed to Step 7.

5 Choose a network.

- Highlight a network SSID and press **Ⓢ**.
- The band on which each SSID operates is indicated by an icon.
- Encrypted networks are indicated by a **🔒** icon. If the selected network is encrypted (**🔒**), you will be prompted to enter the encryption key. If the network is not encrypted, proceed to Step 7.
- If the desired network is not displayed, press **🔍** to search again.

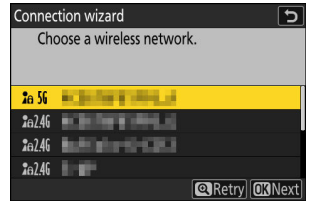

✔ Hidden SSIDs

Networks with hidden SSIDs are indicated by blank entries in the network list.

- To connect to a network with a hidden SSID, highlight a blank entry and press **Ⓢ**. Next, press **Ⓢ**; the camera will prompt you to provide an SSID.
- Enter the network name and press **🔍**. Press **🔍** again; the camera will now prompt you to enter the encryption key.

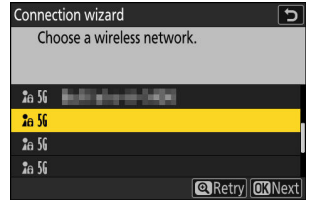

6 Enter the encryption key.

- Press **Ⓜ** and enter the encryption key for the wireless router.
- For more information, see the documentation for the wireless router.
- Press **Ⓜ** when entry is complete.
- Press **Ⓜ** again to initiate the connection. A message will be displayed for a few seconds when the connection is established.

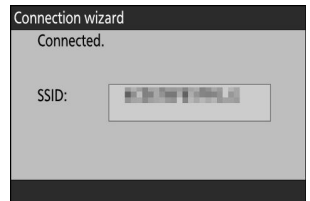
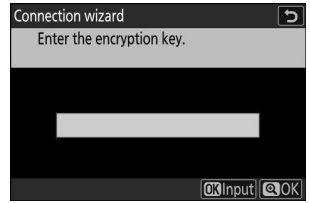

7 Obtain or select an IP address.

- Highlight one of the following options and press **OK**.

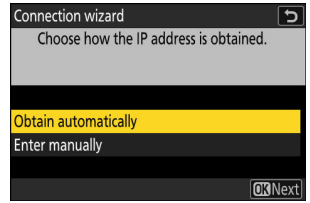

Option	Description
[Obtain automatically]	Select this option if the network is configured to supply the IP address automatically. A "configuration complete" message will be displayed once an IP address has been assigned.
[Enter manually]	Enter the IP address and sub-net mask manually. <ul style="list-style-type: none">• Press OK; you will be prompted to enter the IP address.• Rotate the main command dial to highlight segments.• Press Left or Right to change the highlighted segment and press OK to save changes.• Next, press OK; a "configuration complete" message will be displayed. Press OK again to display the sub-net mask.• Press Left or Right to edit the sub-net mask and press OK; a "configuration complete" message will be displayed.

- Press **OK** to proceed when the "configuration complete" message is displayed.

8 Start pairing.

When prompted, launch the Wireless Transmitter Utility on the computer.

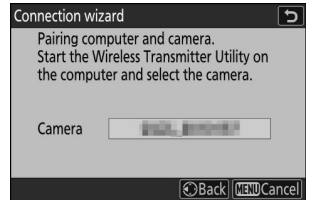

9 Select the camera in the Wireless Transmitter Utility.

Select the name displayed by the camera in Step 8 and click **[Next]**.

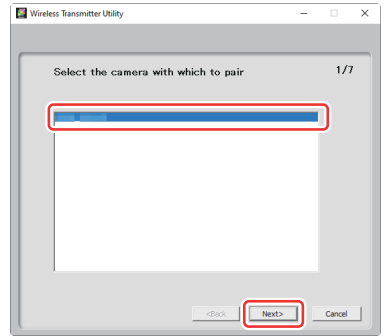

10 In the Wireless Transmitter Utility, enter the authentication code displayed by the camera.

- The camera will display an authentication code.



- Enter the authentication code in the dialog displayed by the Wireless Transmitter Utility and click **[Next]**.

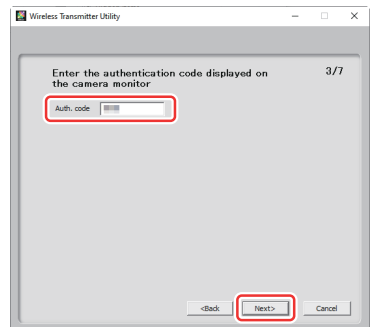

11 Complete the pairing process.

- When the camera displays a message stating that pairing is complete, press **OK**.

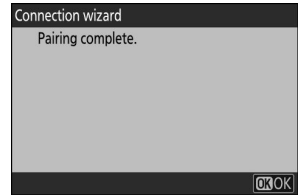

- In the Wireless Transmitter Utility, click **[Next]**; you will be prompted to choose a destination folder. For more information, see online help for the Wireless Transmitter Utility.

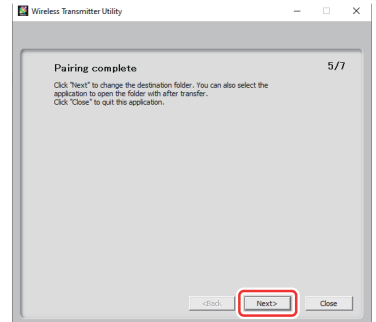

- A wireless connection will be established between the camera and computer when pairing is complete.

12 Check the connection.

When a connection is established, the profile name will be displayed in green in the camera **[Connect to computer]** menu.

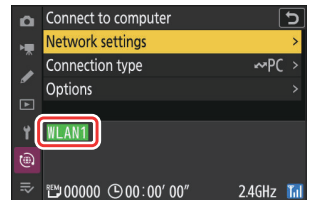

A wireless connection has now been established between the camera and the computer.

Pictures taken with the camera can be uploaded to the computer as described in “Uploading Pictures” ([📖 340](#)).

For information on controlling the camera from a computer using Camera Control Pro 2 or NX Tether, see “Camera Control” ([📖 346](#)).

Ethernet Connections

The camera can connect to computers either directly or via existing networks using a third-party Ethernet cable inserted in the camera's Ethernet connector.

Connecting an Ethernet Cable

Connect an Ethernet cable to the camera's Ethernet connector. Do not use force or attempt to insert the connectors at an angle. Connect the other end of the cable to a computer or router.

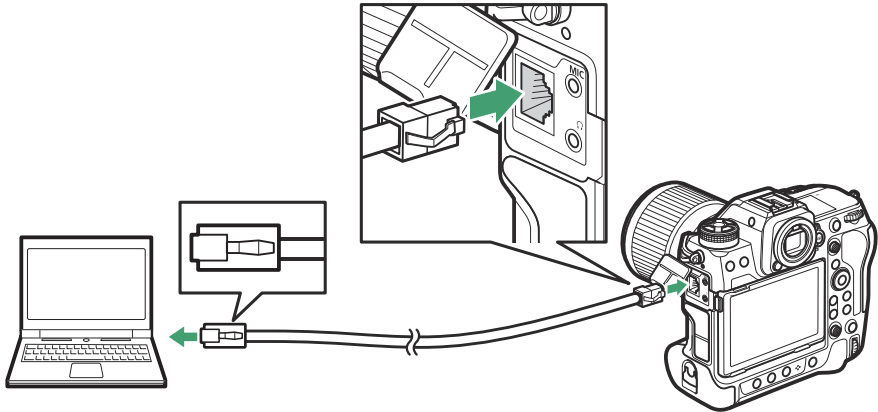

Ethernet Network Profiles

Before proceeding, check that an Ethernet cable is connected to the camera and the Wireless Transmitter Utility ([321](#)) is installed on the computer.

- 1 Select [ON] for [Wired LAN] in the network menu.

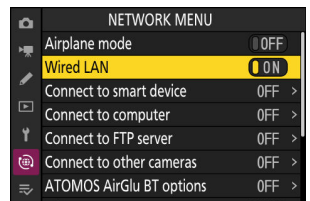

- 2 Select [Connect to computer] in the network menu, then highlight [Network settings] and press \odot .

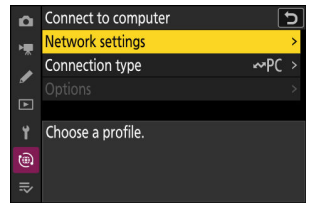

- 3 Highlight [Create profile] and press \odot .

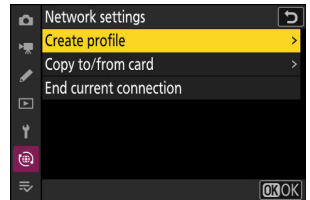

- 4 Name the new profile.

- To proceed to the next step without changing the default name, press \odot .
- Whatever name you choose will appear in the network menu [Connect to computer] > [Network settings] list.
- To rename the profile, press \odot . For information on text entry, see "Text Entry" ([book 71](#)). Press \odot to proceed after entering a name.

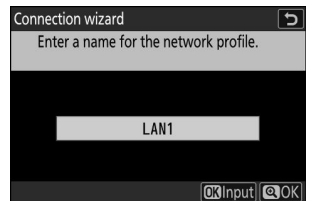

5 Obtain or select an IP address.

- Highlight one of the following options and press **OK**.

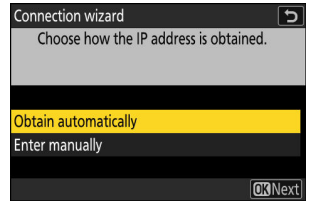

Option	Description
[Obtain automatically]	Select this option if the network is configured to supply the IP address automatically. A "configuration complete" message will be displayed once an IP address has been assigned.
[Enter manually]	Enter the IP address and sub-net mask manually. <ul style="list-style-type: none">• Press OK; you will be prompted to enter the IP address.• Rotate the main command dial to highlight segments.• Press Left or Right to change the highlighted segment and press OK to save changes.• Next, press Q; a "configuration complete" message will be displayed. Press Q again to display the sub-net mask.• Press Left or Right to edit the sub-net mask and press OK; a "configuration complete" message will be displayed.

- Press **OK** to proceed when the "configuration complete" message is displayed.

6 Start pairing.

When prompted, launch the Wireless Transmitter Utility on the computer.

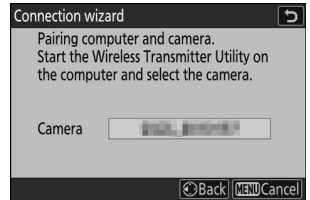

7 Select the camera in the Wireless Transmitter Utility.

Select the name displayed by the camera in Step 6 and click **[Next]**.

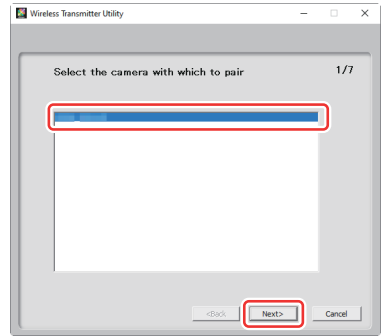

8 In the Wireless Transmitter Utility, enter the authentication code displayed by the camera.

- The camera will display an authentication code.



- Enter the authentication code in the dialog displayed by the Wireless Transmitter Utility and click **[Next]**.

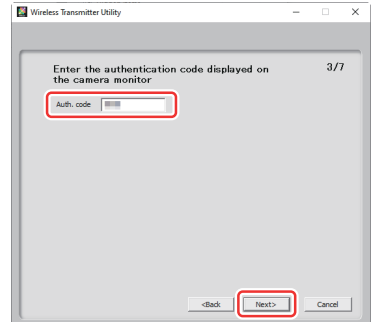

9 Complete the pairing process.

- When the camera displays a message stating that pairing is complete, press **OK**.

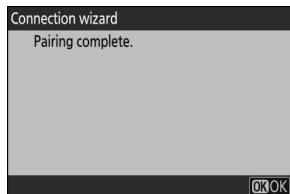

- In the Wireless Transmitter Utility, click **[Next]**; you will be prompted to choose a destination folder. For more information, see online help for the Wireless Transmitter Utility.

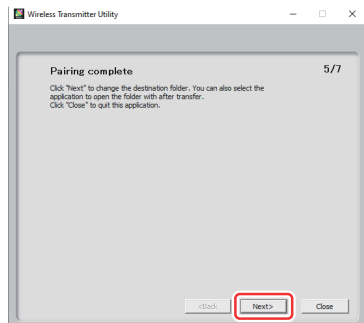

- A connection will be established between the camera and computer when pairing is complete.

10 Check the connection.

When a connection is established, the profile name will be displayed in green in the camera **[Connect to computer]** menu.

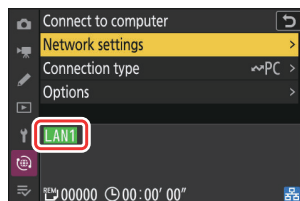

A connection has now been established between the camera and the computer.

Pictures taken with the camera can be uploaded to the computer as described in “Uploading Pictures” ([📖 340](#)).

For information on controlling the camera from a computer using Camera Control Pro 2 or NX Tether, see “Camera Control” ([📖 346](#)).

Uploading Pictures

Pictures can be selected for upload during playback. They can also be uploaded automatically as they are taken.

- Before uploading pictures, connect the camera and computer via Ethernet or a wireless network. Connect using a host profile selected via the network menu [**Connect to computer**] > [**Network settings**] list.

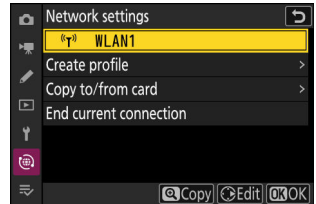

- When a connection is established, the profile name will be displayed in green in the camera [**Connect to computer**] menu.

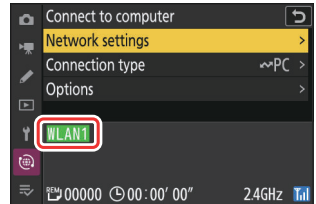

✓ Destination Folders

By default, pictures are uploaded to the following folders:

- Windows: \Users\<(user name)\Pictures\Wireless Transmitter Utility
- macOS: /Users/(user name)/Pictures/Wireless Transmitter Utility

The destination folder can be selected using the Wireless Transmitter Utility. For more information, see online help for the Wireless Transmitter Utility.

✓ Caution: Access Point Mode

Select a host profile and enable camera Wi-Fi before connecting.

✓ Firewall Settings

TCP port 15740 and UDP port 5353 are used for connections to computers. File transfer may be blocked if the server firewall is not configured to allow access to these ports.

Selecting Pictures for Upload

- 1 Select [Picture transfer] for [Connect to computer] > [Connection type] in the network menu.

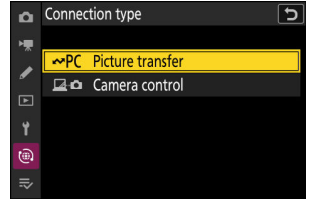

- 2 Press the  button on the camera and select full-frame or thumbnail playback.

- 3 Select a picture and press the  button.

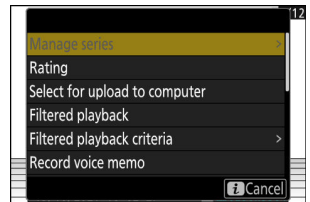

- 4 Highlight [Select for upload to computer] and press .

- A white "priority upload" icon will appear on the picture. If the camera is currently connected to a network, upload will begin immediately and the icon will turn green.
- Otherwise, upload will begin when a connection is established.
- Repeat Steps 3–4 to upload additional pictures.

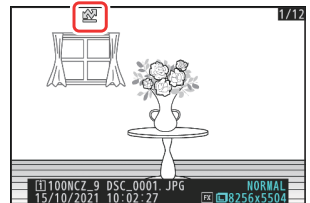

✓ Removing Upload Marking

- Repeat Steps 3–4 to remove upload marking from selected pictures.
 - To remove upload marking from all pictures, select **[Connect to computer]** > **[Options]** > **[Deselect all?]** in the network menu.
-

Tip: Filtering Pictures for Upload

The **[Filtered playback]** item in the playback **i** menu can be used to display only pictures that meet chosen criteria ([📖 252](#)). The pictures can then all be selected for upload by highlighting **[Select all for computer upload]** in the **i** menu and pressing **Ⓜ**.

Uploading Photos as They Are Taken

To upload new photos as they are taken, select **[ON]** for **[Connect to computer]** > **[Options]** > **[Auto upload]** in the network menu.

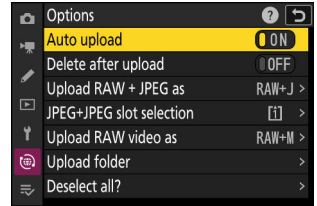

- Upload begins only after the photo has been recorded to the memory card. Be sure a memory card is inserted in the camera.
- Videos are not uploaded automatically. They must instead be uploaded manually from the playback display.

The Upload Icon

Upload status is indicated by the upload icon.

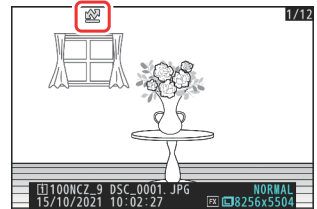

(white): Priority upload

The picture has been manually selected for upload. Pictures marked with this icon will be uploaded before pictures marked  ("upload").

(white): Upload

The picture has been selected for upload but upload has not yet begun.

(green): Uploading

Upload in progress.

(blue): Uploaded

Upload complete.

The [Connect to Computer] Upload Status Display

The [Connect to computer] display shows the following:

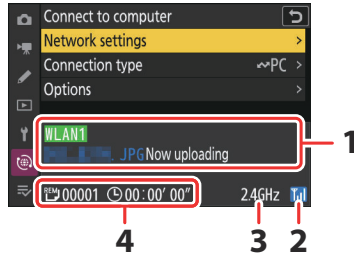

- 1 Status:** The status of the connection to the host. The profile name is displayed in green when a connection is established.
While files are being transferred, the status display shows "Now uploading" preceded by the name of the file being sent. Errors are also displayed here.
- 2 Signal strength:** Ethernet connections are shown by . When the camera is connected to a wireless network, the icon instead shows the wireless signal strength.
- 3 Band:** The band used by the wireless network to which the camera is connected in infrastructure mode.
- 4 Pictures/time remaining:** The number of pictures remaining and the time needed to send them. The time remaining is an estimate only.

✔ **Loss of Signal**

Wireless transmission may be interrupted if the signal is lost. Upload of pictures with upload marking can be resumed by turning the camera off and then on again once the signal has been re-established.

✔ **Caution: During Upload**

Do not remove the memory card or disconnect the Ethernet cable during upload.

✔ **Voice Memos**

Voice memos will be included when the associated pictures are transmitted. They cannot, however, be uploaded separately.

✔ **Turning the Camera Off**

The camera saves transfer marking when turned off and resumes upload when next turned on.

Tip: Connection Status

Connection status is shown by the camera network indicator.

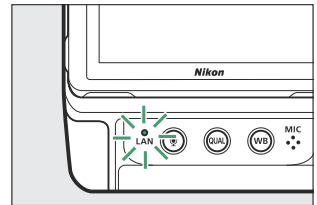

Network indicator	Status
● (off)	No connection.
○ (green)	Waiting to connect.
✱ (flashes green)	Connected.
✱ (flashes amber)	Error.

Camera Control

The camera can be controlled from a computer running Camera Control Pro 2 (available separately) or free NX Tether software. Photos can be saved directly to the computer instead of to the memory card and can consequently be taken even when no memory card is inserted in the camera.

- You will still need to insert a memory card when filming videos.
- Note that the camera standby timer does not expire in camera control mode.
- Before using Camera Control Pro 2 or NX Tether, connect the camera and computer via Ethernet or a wireless LAN. Connect using a host profile selected via the network menu [**Connect to computer**] > [**Network settings**] list.

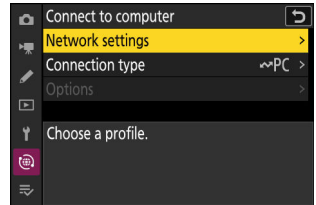

- When a connection is established, the profile name will be displayed in green in the camera [**Connect to computer**] menu.

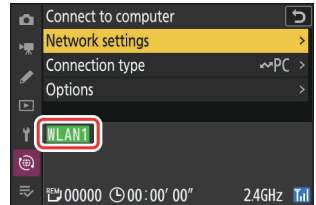

- 1 Select [**Camera control**] for [**Connect to computer**] > [**Connection type**] in the network menu.

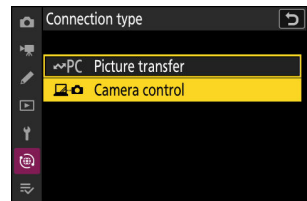

- 2 Launch the copy of Camera Control Pro 2 or NX Tether installed on the host computer.

- 3 Control the camera using Camera Control Pro 2 or NX Tether.

For information on taking pictures using Camera Control Pro 2 or NX Tether, see the online help or other documentation for the software in question.

The [Connect to Computer] Camera Control Display

The [Connect to computer] display shows the following:

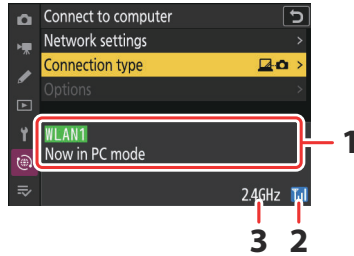

- 1 Status:** The status of the connection to the host. The profile name is displayed in green when a connection is established. Errors are also displayed here ([link 382](#)).
- 2 Signal strength:** Ethernet connections are shown by . When the camera is connected to a wireless network, the icon instead shows the wireless signal strength.
- 3 Band:** The band used by the wireless network to which the camera is connected in infrastructure mode.

Loss of Signal

Loss of signal while the camera is connected to a wireless network may disrupt the connection to the computer. If the camera network indicator flashes amber, select [**End current connection**] for [**Connect to computer**] > [**Network settings**] in the network menu before connecting to the network again. When the signal is re-established, the camera will reconnect to the computer and resume upload of any pictures that have yet to be transferred. Note that upload cannot be resumed if you turn the camera off before transfer is complete.

Caution: Ethernet Networks

Do not disconnect the Ethernet cable during upload or while the camera is on.

Caution: Wireless Networks

Response may slow on wireless networks.

Firewall Settings

TCP port 15740 and UDP port 5353 are used for connections to computers. File transfer may be blocked if the server firewall is not configured to allow access to these ports.

Tip: Connection Status

Connection status is shown by the camera network indicator.

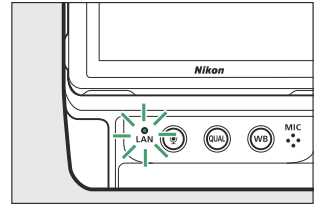

Network indicator	Status
● (off)	No connection.
○ (green)	Waiting to connect.
✦ (flashes green)	Connected.
✦ (flashes amber)	Error.

Ending the Connection to the Computer

You can end the connection by:

- turning the camera off,
- selecting **[End current connection]** for **[Connect to computer]** > **[Network settings]** in the network menu, or
- connecting to a smart device via Wi-Fi or Bluetooth.

Access-Point Mode

An error will occur if the computer's wireless connection is disabled before the camera's. Disable camera's connection first.

FTP Servers: Connecting via Ethernet or Wireless LAN

The camera can connect to FTP servers and upload pictures via existing networks using Wi-Fi (built-in wireless LAN) or a third-party Ethernet cable inserted in the camera's Ethernet connector. The camera can also be connected to FTP servers directly.

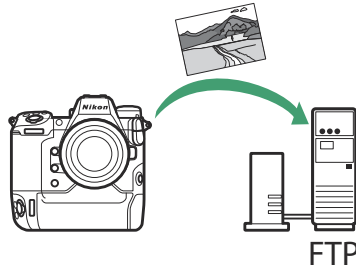

✓ FTP Servers

- Servers can be configured using standard FTP services—including IIS (Internet Information Services)—available with Windows 11 and Windows 10.
- Internet FTP connections and connection to FTP servers running third-party software are not supported.

✓ FTPS Servers

- Before connecting to a server via FTPS, you will need to load a root certificate onto the camera. This can be done using [**Connect to FTP server**] > [**Options**] > [**Manage root certificate**] > [**Import root certificate**] in the network menu.
 - Contact the network administrator for the FTPS server in question for information on acquiring root certificates.
-

Wireless LAN

The camera can connect to FTP servers either by direct wireless link (access-point mode) or via a wireless router on an existing network, including home networks (infrastructure mode).

Direct Wireless Connection (Access-Point Mode)

The camera and FTP server connect via direct wireless link. The camera acts as a wireless LAN access point, letting you connect when working outdoors and in other situations in which the computer is not already connected to a wireless network and eliminating the need for complicated adjustments to settings.



- Create a host profile using the camera connection wizard.
- Confirm that **[OFF]** is selected for **[Wired LAN]** in the network menu.

1 Select **[Connect to FTP server]** in the network menu, then highlight **[Network settings]** and press **[OK]**.

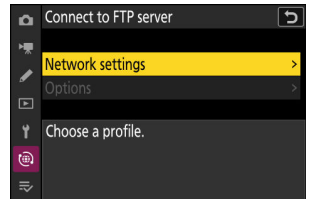

2 Highlight **[Create profile]** and press **[OK]**.

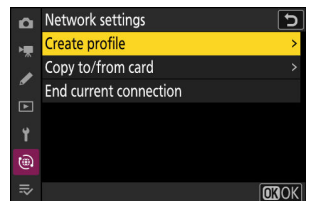

3 Highlight [Connection wizard] and press .

The connection wizard will launch.

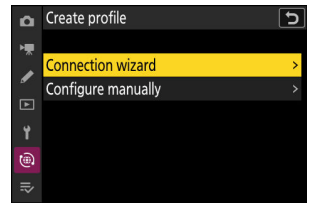

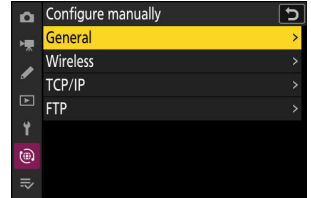

Manual Configuration

Choose [**Configure manually**] to configure settings manually.



4 Name the new profile.

- To proceed to the next step without changing the default name, press .
- Whatever name you choose will appear in the network menu [**Connect to FTP server**] > [**Network settings**] list.
- To rename the profile, press . For information on text entry, see "Text Entry" ([book 71](#)). Press  to proceed after entering a name.

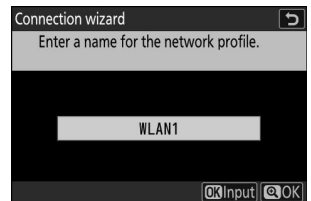

5 Highlight [Direct connection to computer] and press \odot .

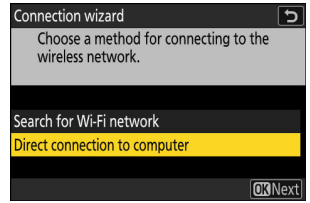

The camera SSID and encryption key will be displayed.

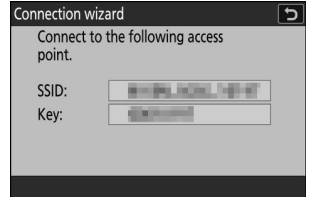

6 Establish a connection to the camera.

Windows:

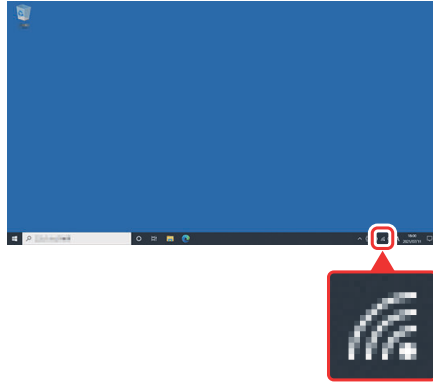

- Click the wireless LAN icon in the taskbar.
- Select the SSID displayed by the camera in Step 5.
- When prompted to enter the network security key, enter the encryption key displayed by the camera in Step 5. The computer will initiate a connection to the camera.

macOS:

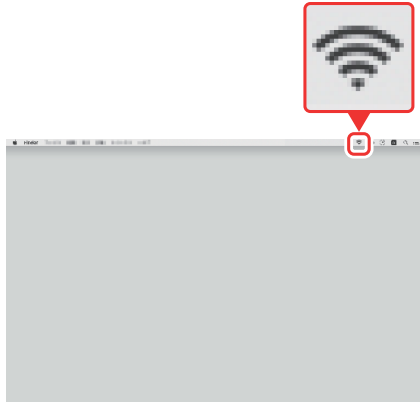

- Click the wireless LAN icon in the menu bar.
- Select the SSID displayed by the camera in Step 5.
- When prompted to enter the network security key, enter the encryption key displayed by the camera in Step 5. The computer will initiate a connection to the camera.

7 Choose the server type.

Highlight **[FTP]**, **[SFTP]** (SSH FTP), or **[FTPS]** (FTP-SSL) and press **ⓧ** to display a dialog where you can choose a login method.

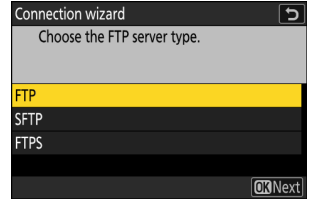

8 Log in.

Highlight one of the following options and press **ⓧ**.

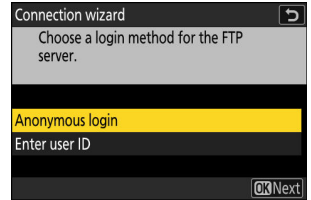

Option	Description
[Anonymous login]	Select this option if the server does not require a user ID or password. This option can only be used with servers that are configured for anonymous login. If login is successful, the camera will prompt you to choose a destination.
[Enter user ID]	Enter a user ID and password. Press ⓧ to log in when entry is complete. If login is successful, the camera will prompt you to choose a destination.

✓ Firewall Settings

- The ports used for FTP vary with the server type. The port numbers are listed below.
 - **[FTP]**: TCP ports 21 and 32768 through 61000
 - **[SFTP]**: TCP ports 22 and 32768 through 61000
 - **[FTPS]**: TCP ports 21 and 32768 through 61000
- File transfer may be blocked if the server firewall is not configured to allow access to the appropriate ports.

9 Choose a destination folder.

Highlight one of the following options and press **ⓧ**.

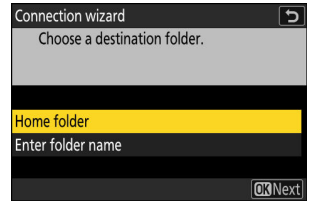

Option	Description
[Home folder]	Select this option to select the server's home folder as the destination for pictures uploaded from the camera. A "setup complete" dialog will be displayed if the operation is successful.
[Enter folder name]	Enter the destination folder name manually. The folder must already exist on the server. Enter the folder name and path when prompted and press ⓧ to display the "setup complete" dialog.

10 Check the connection.

When a connection is established, the profile name will be displayed in green in the camera [Connect to FTP server] menu.

- If the profile name is not displayed in green, connect to the camera via the wireless network list on the FTP server.

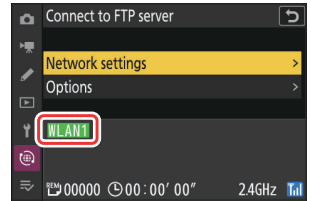

A wireless connection has now been established between the camera and the FTP server.

- “FTP” will appear in the camera shooting display once a connection is established. If a connection error occurs, this indicator will be displayed in red together with a  icon.

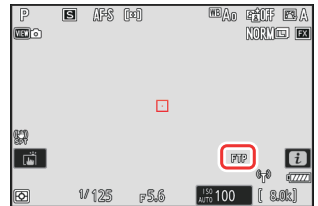

Pictures taken with the camera can be uploaded to the FTP server as described in “Uploading Pictures” ([375](#)).

Connecting in Infrastructure Mode

The camera connects to an FTP server on an existing network (including home networks) via a wireless router.

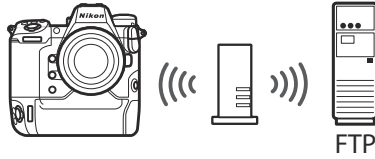

- Create a host profile using the camera connection wizard.
- Before connecting to a wireless network, confirm that **[OFF]** is selected for **[Wired LAN]** in the network menu.

Tip: Infrastructure Mode

Infrastructure mode supports connection to FTP servers on different networks.

- 1 Select **[Connect to FTP server]** in the network menu, then highlight **[Network settings]** and press **[OK]**.

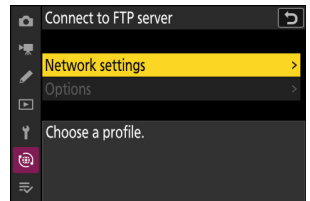

- 2 Highlight **[Create profile]** and press **[OK]**.

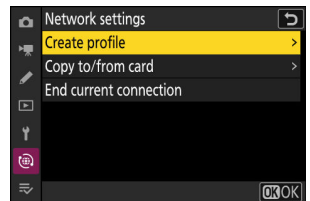

3 Highlight [Connection wizard] and press \odot .

The connection wizard will launch.

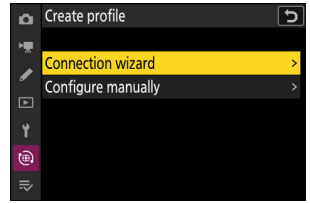

Manual Configuration

Choose [**Configure manually**] to configure settings manually.

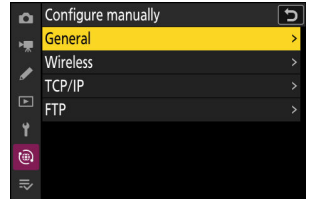

4 Name the new profile.

- To proceed to the next step without changing the default name, press \odot .
- Whatever name you choose will appear in the network menu [**Connect to FTP server**] > [**Network settings**] list.
- To rename the profile, press \otimes . For information on text entry, see "Text Entry" ([book 71](#)). Press \odot to proceed after entering a name.

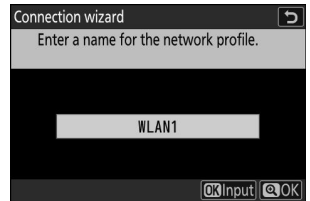

5 Highlight [Search for Wi-Fi network] and press **↵**.

The camera will search for networks currently active in the vicinity and list them by name (SSID).

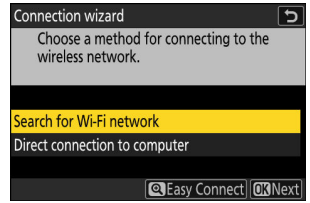

✓ [Easy Connect]

- To connect without entering an SSID or encryption key, press **↵** in Step 5. Next, press **↵** and choose from the following options:

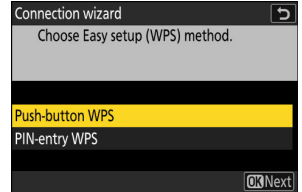

Option	Description
[Push-button WPS]	For routers that support push-button WPS. Press the WPS button on the router and then press the camera ↵ button to connect.
[PIN-entry WPS]	The camera will display a PIN. Using a computer, enter the PIN on the router. For more information, see the documentation provided with the router.

- After connecting, proceed to Step 8.

6 Choose a network.

- Highlight a network SSID and press **Ⓢ**.
- The band on which each SSID operates is indicated by an icon.
- Encrypted networks are indicated by a **🔒** icon. If the selected network is encrypted (**🔒**), you will be prompted to enter the encryption key. If the network is not encrypted, proceed to Step 8.
- If the desired network is not displayed, press **🔍** to search again.

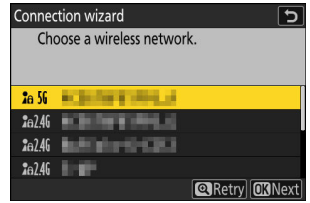

✓ Hidden SSIDs

Networks with hidden SSIDs are indicated by blank entries in the network list.

- To connect to a network with a hidden SSID, highlight a blank entry and press **Ⓢ**. Next, press **Ⓢ**; the camera will prompt you to provide an SSID.
- Enter the network name and press **🔍**. Press **🔍** again; the camera will now prompt you to enter the encryption key.

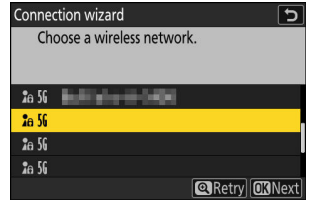

7 Enter the encryption key.

- Press **Ⓜ** and enter the encryption key for the wireless router.
- For more information, see the documentation for the wireless router.
- Press **Ⓜ** when entry is complete.
- Press **Ⓜ** again to initiate the connection. A message will be displayed for a few seconds when the connection is established.

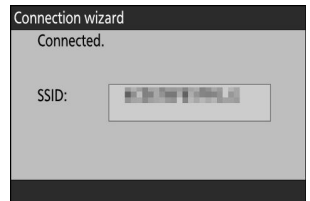
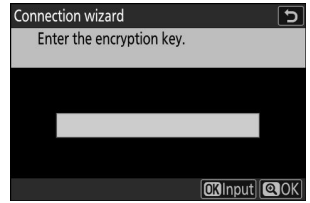

8 Obtain or select an IP address.

- Highlight one of the following options and press **Ⓢ**.

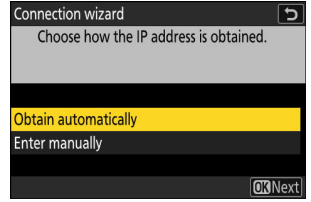

Option	Description
[Obtain automatically]	Select this option if the network is configured to supply the IP address automatically. A "configuration complete" message will be displayed once an IP address has been assigned.
[Enter manually]	Enter the IP address and sub-net mask manually. <ul style="list-style-type: none">• Press Ⓢ; you will be prompted to enter the IP address.• Rotate the main command dial to highlight segments.• Press ⬅ or ➡ to change the highlighted segment and press Ⓢ to save changes.• Next, press Ⓢ; a "configuration complete" message will be displayed. Press Ⓢ again to display the sub-net mask.• Press ⬅ or ➡ to edit the sub-net mask and press Ⓢ; a "configuration complete" message will be displayed.

- Press **Ⓢ** to proceed when the "configuration complete" message is displayed.

9 Choose the server type.

Highlight **[FTP]**, **[SFTP]** (SSH FTP), or **[FTPS]** (FTP-SSL) and press **Ⓢ** to display a dialog where you can enter the server address.

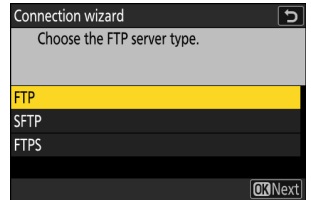

10 Enter the server address.

- Press **Ⓜ** to enter the server URL or IP address.

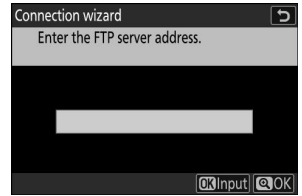

- Press **Ⓜ** when entry is complete.



- Press **Ⓜ** again to connect to the FTP server. You will be prompted to choose a login method.



11 Log in.

Highlight one of the following options and press **Ⓢ**.

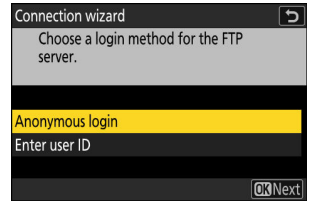

Option	Description
[Anonymous login]	Select this option if the server does not require a user ID or password. This option can only be used with servers that are configured for anonymous login. If login is successful, the camera will prompt you to choose a destination.
[Enter user ID]	Enter a user ID and password. Press Ⓢ to log in when entry is complete. If login is successful, the camera will prompt you to choose a destination.

Firewall Settings

- The ports used for FTP vary with the server type. The port numbers are listed below.
 - **[FTP]**: TCP ports 21 and 32768 through 61000
 - **[SFTP]**: TCP ports 22 and 32768 through 61000
 - **[FTPS]**: TCP ports 21 and 32768 through 61000
- File transfer may be blocked if the server firewall is not configured to allow access to the appropriate ports.

12 Choose a destination folder.

Highlight one of the following options and press **ⓧ**.

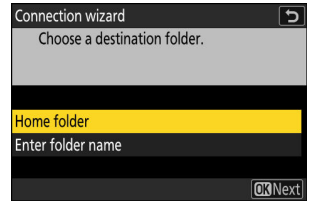

Option	Description
[Home folder]	Select this option to select the server's home folder as the destination for pictures uploaded from the camera. A "setup complete" dialog will be displayed if the operation is successful.
[Enter folder name]	Enter the destination folder name manually. The folder must already exist on the server. Enter the folder name and path when prompted and press ⓧ to display the "setup complete" dialog.

13 Check the connection.

When a connection is established, the profile name will be displayed in green in the camera [Connect to FTP server] menu.

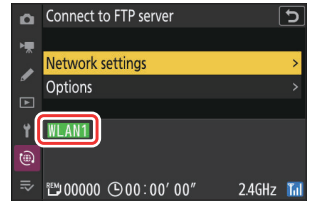

A wireless connection has now been established between the camera and the FTP server.

- "FTP" will appear in the camera shooting display once a connection is established. If a connection error occurs, this indicator will be displayed in red together with a  icon.

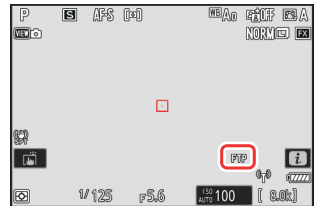

Pictures taken with the camera can be uploaded to the FTP server as described in "Uploading Pictures" ([📖 375](#)).

Ethernet

The camera can connect to FTP servers either directly or via existing networks using a third-party Ethernet cable inserted in the camera's Ethernet connector.

Connecting an Ethernet Cable

Connect an Ethernet cable to the camera's Ethernet connector. Do not use force or attempt to insert the connectors at an angle. Connect the other end of the cable to the FTP server or a router.

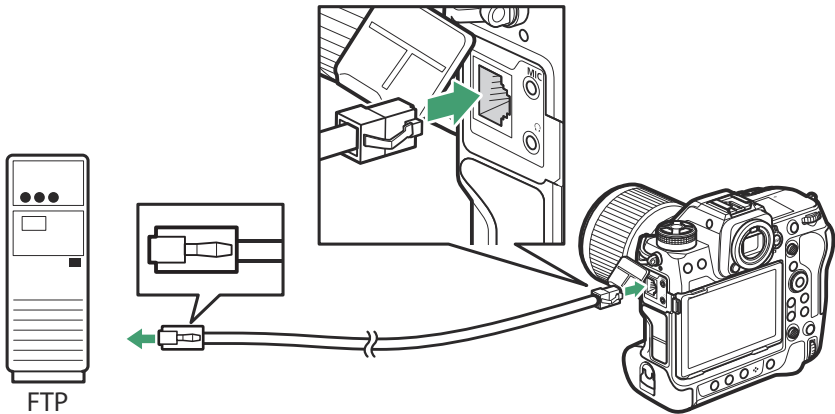

- 1 Select [ON] for [Wired LAN] in the network menu.

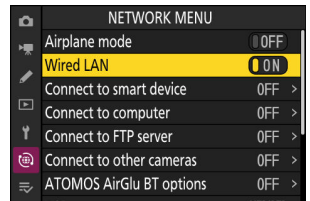

- 2 Select [Connect to FTP server] in the network menu, then highlight [Network settings] and press .

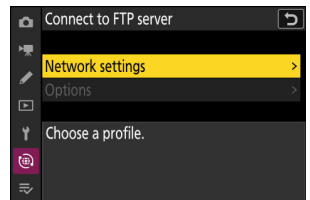

3 Highlight [Create profile] and press \odot .

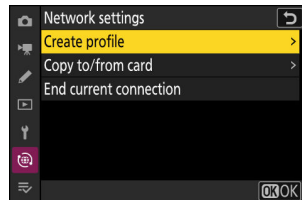

4 Highlight [Connection wizard] and press \odot .

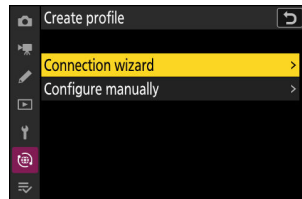

The connection wizard will launch.

Manual Configuration

Choose [**Configure manually**] to configure settings manually.

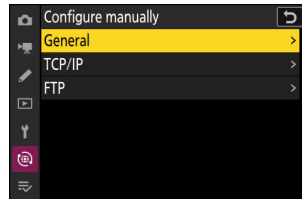

5 Name the new profile.

- To proceed to the next step without changing the default name, press \odot .
- Whatever name you choose will appear in the network menu [**Connect to FTP server**] > [**Network settings**] list.
- To rename the profile, press \odot . For information on text entry, see "Text Entry" ([71](#)). Press \odot to proceed after entering a name.

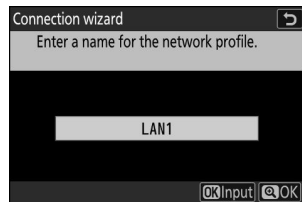

6 Obtain or select an IP address.

- Highlight one of the following options and press **Ⓢ**.

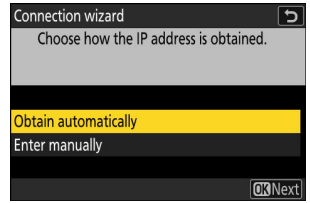

Option	Description
[Obtain automatically]	Select this option if the network is configured to supply the IP address automatically. A "configuration complete" message will be displayed once an IP address has been assigned.
[Enter manually]	Enter the IP address and sub-net mask manually. <ul style="list-style-type: none">• Press Ⓢ; you will be prompted to enter the IP address.• Rotate the main command dial to highlight segments.• Press ⏪ or ⏩ to change the highlighted segment and press Ⓢ to save changes.• Next, press Ⓢ; a "configuration complete" message will be displayed. Press Ⓢ again to display the sub-net mask.• Press ⏪ or ⏩ to edit the sub-net mask and press Ⓢ; a "configuration complete" message will be displayed.

- Press **Ⓢ** to proceed when the "configuration complete" message is displayed.

7 Choose the server type.

Highlight **[FTP]**, **[SFTP]** (SSH FTP), or **[FTPS]** (FTP-SSL) and press **Ⓢ** to display a dialog where you can enter the server address.

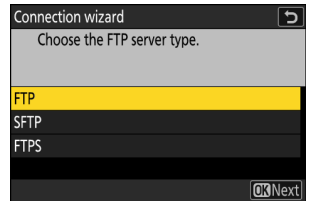

8 Enter the server address.

- Press **Ⓜ** to enter the server URL or IP address.

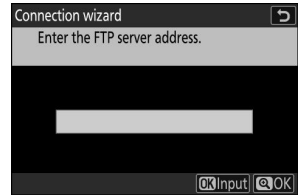

- Press **Ⓜ** when entry is complete.



- Press **Ⓜ** again to connect to the FTP server. You will be prompted to choose a login method.



9 Log in.

Highlight one of the following options and press **Ⓢ**.

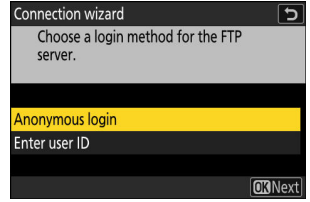

Option	Description
[Anonymous login]	Select this option if the server does not require a user ID or password. This option can only be used with servers that are configured for anonymous login. If login is successful, the camera will prompt you to choose a destination.
[Enter user ID]	Enter a user ID and password. Press Ⓢ to log in when entry is complete. If login is successful, the camera will prompt you to choose a destination.

Firewall Settings

- The ports used for FTP vary with the server type. The port numbers are listed below.
 - [FTP]: TCP ports 21 and 32768 through 61000
 - [SFTP]: TCP ports 22 and 32768 through 61000
 - [FTPS]: TCP ports 21 and 32768 through 61000
- File transfer may be blocked if the server firewall is not configured to allow access to the appropriate ports.

10 Choose a destination folder.

Highlight one of the following options and press **ⓧ**.

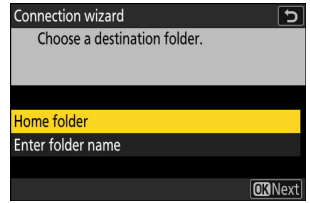

Option	Description
[Home folder]	Select this option to select the server's home folder as the destination for pictures uploaded from the camera. A "setup complete" dialog will be displayed if the operation is successful.
[Enter folder name]	Enter the destination folder name manually. The folder must already exist on the server. Enter the folder name and path when prompted and press ⓧ to display the "setup complete" dialog.

11 Check the connection.

When a connection is established, the profile name will be displayed in green in the camera [Connect to FTP server] menu.

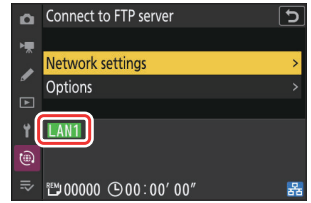

A connection has now been established between the camera and the FTP server.

- "FTP" will appear in the camera shooting display once a connection is established. If a connection error occurs, this indicator will be displayed in red together with a  icon.

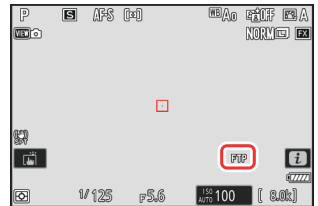

Pictures taken with the camera can be uploaded to the FTP server as described in "Uploading Pictures" ([375](#)).

Uploading Pictures

Pictures can be selected for upload during playback. They can also be uploaded automatically as they are taken.

- Before uploading pictures, connect the camera and FTP server via Ethernet or a wireless network. Connect using a host profile selected via the **[Connect to FTP server] > [Network settings]** list.
- When a connection is established, the profile name will be displayed in green in the camera **[Connect to FTP server]** menu.

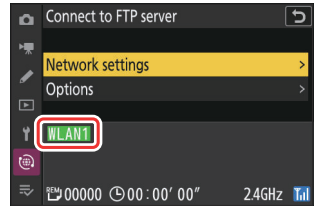
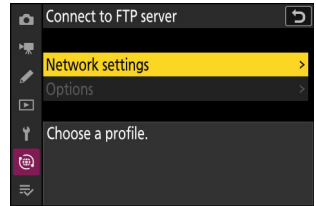

Caution: Access Point Mode

Select a host profile and enable camera Wi-Fi before connecting.

Selecting Pictures for Upload

1 Press the  button on the camera and select full-frame or thumbnail playback.

2 Select a picture and press the  button.

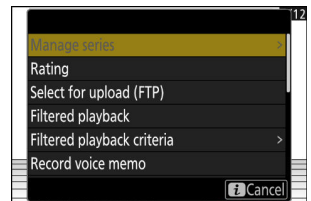

3 Highlight [Select for upload (FTP)] and press **OK**.

- A white “priority upload” icon will appear on the picture. If the camera is currently connected to a network, upload will begin immediately and the icon will turn green.
- Otherwise, upload will begin when a connection is established.
- Repeat Steps 2–3 to upload additional pictures.

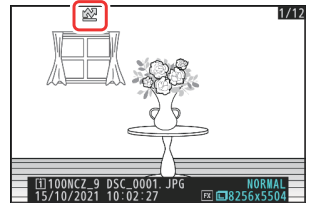

✓ Removing Upload Marking

- Repeat Steps 2–3 to remove upload marking from selected pictures.
- To remove upload marking from all pictures, select **[Connect to FTP server] > [Options] > [Deselect all?]** in the network menu.

Tip: Filtering Pictures for Upload

The **[Filtered playback]** item in the playback **i** menu can be used to display only pictures that meet chosen criteria ([link 252](#)). The pictures can then all be selected for upload by highlighting **[Select all for upload (FTP)]** in the **i** menu and pressing **OK**.

Uploading Photos as They Are Taken

To upload new photos as they are taken, select **[ON]** for **[Connect to FTP server]** > **[Options]** > **[Auto upload]** in the network menu.

- Upload begins only after the photo has been recorded to the memory card. Be sure a memory card is inserted in the camera.
- Videos are not uploaded automatically. They must instead be uploaded manually from the playback display.

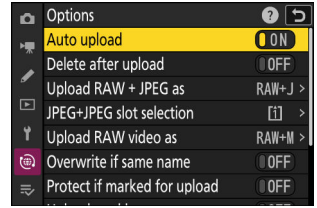

The Upload Icon

Upload status is indicated by the upload icon.

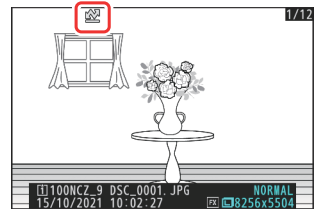

(white): Priority upload

The picture has been manually selected for upload. Pictures marked with this icon will be uploaded before pictures marked  ("upload").

(white): Upload

The picture has been selected for upload but upload has not yet begun.

(green): Uploading

Upload in progress.

(blue): Uploaded

Upload complete.

The [Connect to FTP Server] Upload Status Display

The [Connect to FTP server] display shows the following:

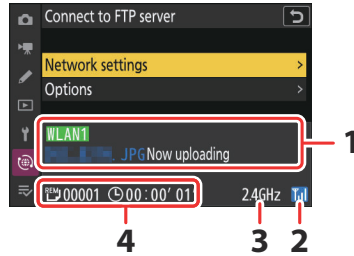

1 Status:

The status of the connection to the host. The profile name is displayed in green when a connection is established.

While files are being transferred, the status display shows "Now uploading" preceded by the name of the file being sent. Errors and error codes are also displayed here ([383](#)).

2 Signal strength: Ethernet connections are shown by . When the camera is connected to a wireless network, the icon instead shows the wireless signal strength.

3 Band: The band used by the wireless network to which the camera is connected in infrastructure mode.

4 Pictures/time remaining: The number of pictures remaining and the time needed to send them. The time remaining is an estimate only.

✓ Loss of Signal

Wireless transmission may be interrupted if the signal is lost. Upload of pictures with upload marking can be resumed by turning the camera off and then on again once the signal has been re-established.

✓ Caution: During Upload

Do not remove the memory card or disconnect the Ethernet cable during upload.

✓ Caution: Uploading Protected Pictures via FTP

The copies on the FTP server will not be protected even if the originals are. Markings can be added using ratings ([250](#)).

Voice Memos

Voice memos will be included when the associated pictures are transmitted. They cannot, however, be uploaded separately.

Turning the Camera Off

The camera saves transfer marking when turned off and resumes upload when next turned on.

Tip: Connection Status

Connection status is shown by the camera network indicator.

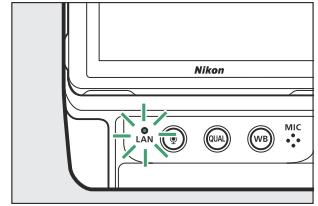

Network indicator	Status
● (off)	No connection.
○ (green)	Waiting to connect.
✦ (flashes green)	Connected.
✦ (flashes amber)	Error.

Ending the Connection to the FTP Server

You can end the connection by:

- turning the camera off,
- selecting [**End current connection**] for [**Connect to FTP server**] > [**Network settings**] in the network menu, or
- connecting to a smart device via Wi-Fi or Bluetooth.

Access-Point Mode

An error will occur if the FTP server's wireless connection is disabled before the camera's. Disable camera's connection first.

Troubleshooting Wireless LAN and Ethernet Connections

Refer to this section for information on errors involving wireless LAN and Ethernet connections.

- For information on the Wireless Transmitter Utility, see the utility's online help.

Problems and Solutions

Solutions to some common issues are listed below.

Problem	Solution
<ul style="list-style-type: none">• The camera displays a wireless error.• The camera displays a TCP/IP error.• The camera displays an FTP error.	<p>Connection settings require adjustment. Check settings for the wireless router, FTP server, or host computer and adjust camera settings appropriately (📖 322, 📖 351).</p> <hr/> <p>Check the error code, if any. For more information, see "Error Codes" (📖 383).</p>
"Connecting to computer" does not clear from the camera display.	Check firewall settings (📖 340 , 📖 355).
The camera displays the message, "Ethernet cable is not connected".	Connect an Ethernet cable or select [OFF] for [Wired LAN] (📖 335 , 📖 368 , 📖 782).
The camera displays a "no memory card" error.	The memory card is inserted incorrectly or not at all. Check that card is inserted correctly (📖 86).
Upload is interrupted and fails to resume.	Upload will resume if the camera is turned off and then on again (📖 345).
The connection is unreliable.	If the camera is connected in infrastructure mode, check that the router is set to a channel between 1 and 8 (📖 787 , 📖 792).

Error Codes

The following messages and error codes may be displayed if an error occurs while the camera is connected to an FTP server via Ethernet or wireless LAN.

• [Wireless Error.]

Error code	Solution
Err.11	Confirm that the device to which you are attempting to connect is on.
	Check the SSID (📖 792).
Err.12	Confirm that you are using the correct password for the selected SSID.
	Confirm that you are using the correct authentication method (📖 792).
Err.13	Confirm that the device to which you are attempting to connect is on.
	Turn the camera off and then on again.
Err.1F	Turn the camera off and then on again.

• [TCP/IP Error.]

Error code	Solution
Err.21	Check that the TCP/IP address and sub-net mask are correct (📖 792).
Err.22	Duplicate TCP/IP address. Choose a different address (📖 792).

• [PTP/IP Error.]

Error code	Solution
Err.41	Turn the camera off and then on again.

• **[FTP Error.]**

Error code	Solution
Err.31	Check that the FTP server address is correct (book 792).
Err.32	Check that the login name and password are correct (book 792).
Err.34	Check that the destination folder name is correct (book 792).
Err.35	Confirm that the destination folder is not write-protected.
Err.36	Check the DNS (book 792).
Err.37	Check firewall settings (book 355).
	Check PASV mode settings (book 792).
Err.3F	Turn the camera off and then on again.

• **[Error authenticating FTP server credentials.]**

Error code	Solution
Err.61	Check that the FTP server supports TLS 1.2 or later.
Err.62	Check that you are using the correct root certificate (book 350 , book 797).
Err.63	
Err.64	The camera cannot connect because the FTP server has requested a client certificate. Check FTP server settings.
Err.65	Turn the camera off and then on again.

Connecting to Other Cameras

What Inter-camera Connections Can Do for You

Camera-Based Remote Photography (Synchronized Release)

A master camera can be used to release the shutters on up to ten remote cameras in the same group ([📖 386](#)).

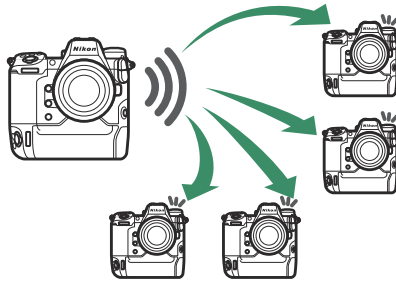

Clock Synchronization (Synchronize Date and Time)

Synchronize the clocks on multiple cameras via a network ([📖 402](#)).

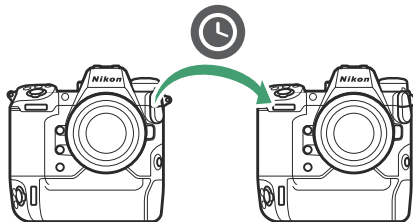

Synchronized Release

Configuring and Using Synchronized Release

Follow the steps below to create host profiles for synchronized release. Each camera saves the pictures it takes to its own memory card. Repeat the process to create identical profiles for each camera.

Wireless LAN

To create host profiles when connecting via wireless LAN:

- 1 Select **[Connect to other cameras]** in the network menu, then highlight **[Network settings]** and press **↵**.

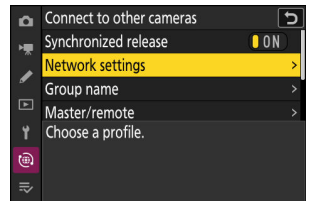

- 2 Highlight **[Create profile]** and press **⊗**.

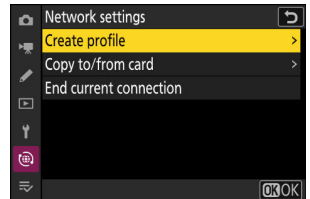

- 3 Name the new profile.

- To proceed to the next step without changing the default name, press **⊗**.
- Whatever name you choose will appear in the network menu **[Connect to other cameras] > [Network settings]** list.
- To rename the profile, press **⊗**. For information on text entry, see "Text Entry" ([71](#)). Press **⊗** to proceed after entering a name.

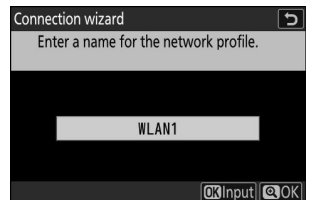

4 Highlight [Search for Wi-Fi network] and press **Ⓜ**.

The camera will search for networks currently active in the vicinity and list them by name (SSID).

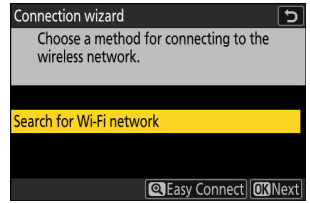

✓ [Easy Connect]

- To connect without entering an SSID or encryption key, press **Ⓜ** in Step 4. Next, press **Ⓜ** and choose from the following options:

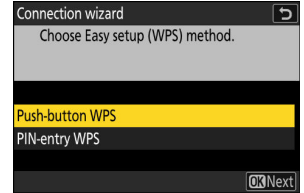

Option	Description
[Push-button WPS]	For routers that support push-button WPS. Press the WPS button on the router and then press the camera Ⓜ button to connect.
[PIN-entry WPS]	The camera will display a PIN. Using a computer, enter the PIN on the router. For more information, see the documentation provided with the router.

- After connecting, proceed to Step 7.

5 Choose a network.

- Highlight a network SSID and press **Ⓢ**.
- The band on which each SSID operates is indicated by an icon.
- Encrypted networks are indicated by a **🔒** icon. If the selected network is encrypted (**🔒**), you will be prompted to enter the encryption key. If the network is not encrypted, proceed to Step 7.
- If the desired network is not displayed, press **🔍** to search again.

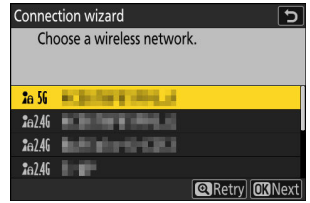

✓ Hidden SSIDs

Networks with hidden SSIDs are indicated by blank entries in the network list.

- To connect to a network with a hidden SSID, highlight a blank entry and press **Ⓢ**. Next, press **Ⓢ**; the camera will prompt you to provide an SSID.
- Enter the network name and press **🔍**. Press **🔍** again; the camera will now prompt you to enter the encryption key.

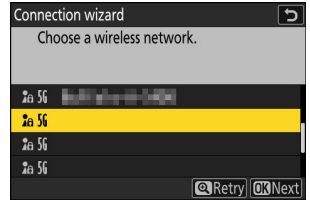

6 Enter the encryption key.

- Press **Ⓜ** and enter the encryption key for the wireless router.
- For more information on the wireless router encryption key, see the documentation for the wireless router.
- Press **Ⓜ** when entry is complete.
- Press **Ⓜ** again to initiate the connection. A message will be displayed for a few seconds when the connection is established.

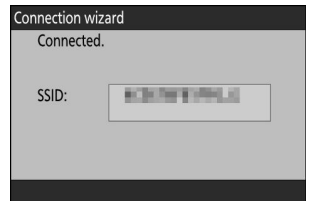
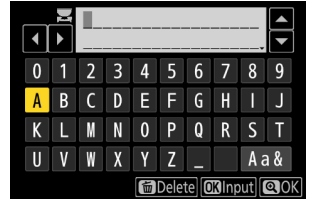
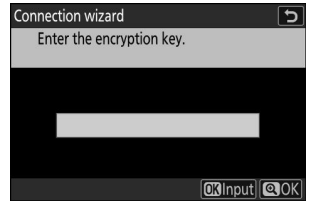

7 Obtain or select an IP address.

- Highlight one of the following options and press **OK**.

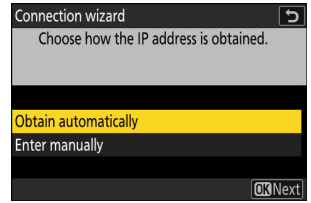

Option	Description
[Obtain automatically]	<p>Select this option if the network is configured to supply the IP address automatically. A “configuration complete” message will be displayed once an IP address has been assigned.</p> <ul style="list-style-type: none"> • It is recommended that you note the remote camera IP address, as you will need it in subsequent steps.
[Enter manually]	<p>Enter the IP address and sub-net mask manually.</p> <ul style="list-style-type: none"> • Press OK; you will be prompted to enter the IP address. • Rotate the main command dial to highlight segments. • Press Left or Right to change the highlighted segment and press OK to save changes. • Next, press OK; a “configuration complete” message will be displayed. Press OK again to display the sub-net mask. • Press Left or Right to edit the sub-net mask and press OK; a “configuration complete” message will be displayed.

- Press **OK** to proceed when the “configuration complete” message is displayed.
- The profile name is displayed when a connection is established.

8 Highlight [Group name], press **OK**, and enter a group name.

Enter a group name for the synchronized cameras. Group names can be up to eight characters long.

- All master and remote cameras on the network must be in the same group.

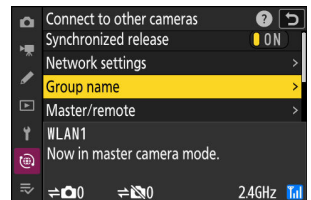

9 Highlight [Master/remote] and press .

Choose a role for each camera from “master” and “remote”.

- **[Master camera]:** Pressing the shutter-release button on the master camera releases the shutters on the remote cameras. Each group can have only one master. If the group has multiple master cameras, only the first to connect to the network will actually serve in that capacity.
- **[Remote camera]:** The shutters on the remote cameras are synchronized with the shutter on the master camera.

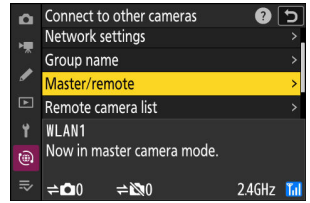

10 Repeat Steps 1 through 9 for the remaining cameras.

When configuring remote cameras, be sure to select **[Remote camera]** in Step 9.

11 On the master camera, highlight [Remote camera list] and press .

Cameras assigned the remote camera role in Step 9 are added to the master camera's remote camera list. The master camera can store information for up to 10 remote cameras in slots [01] through [10].

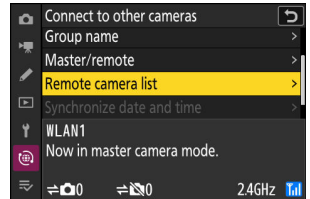

12 Highlight the desired slot and press .

Remote camera options will be displayed.

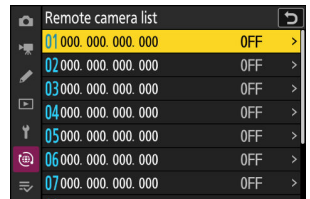



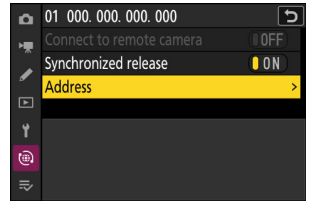

13 Highlight [Address] and press .

You will be prompted to enter an IP address.



14 Enter the remote camera IP address.

Enter the remote camera IP address you noted in Step 7.

- Rotate the main command dial to highlight segments.
- Press  or  to change the highlighted segment and press  to proceed.
- Press  to add the remote camera to the master camera remote camera list and establish a connection.

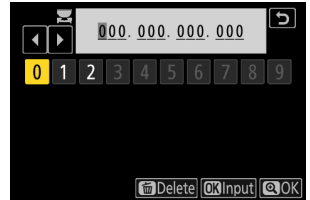

Tip: Viewing Remote Camera IP Addresses

To view a remote camera's IP address, select [**Connect to other cameras**] > [**Network settings**] in the camera's network menu, highlight a synchronized release host profile, press , and select [**TCP/IP**].

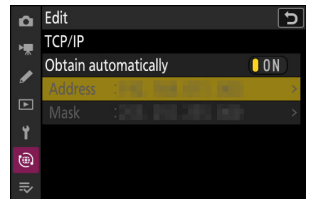

15 Add the remaining remote cameras.

- When connecting to wireless networks, the cameras will display the band used by the selected SSID.
- The master camera shows the number of cameras in the group currently connected or not connected.

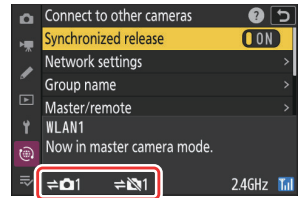

- A  icon appears in the master camera shooting display together with the number of remote cameras connected.

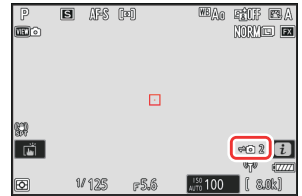

Connection Errors

In the event of remote camera connection errors, the remote camera count in the master camera shooting display will turn red and instead show the number of remote cameras that failed to connect.

16 Take pictures.

- Pressing the shutter-release button on the master camera releases the shutters on the remote cameras.

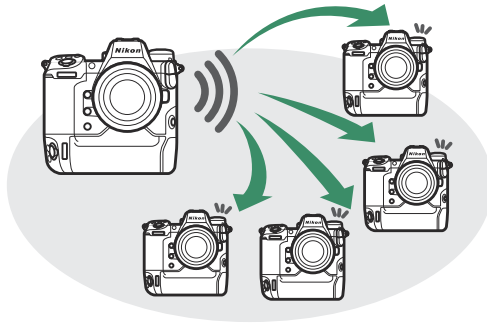

- Note that the standby timers will not expire automatically when the cameras are in synchronized release mode.

Ethernet

Follow the steps below to create host profiles for Ethernet connections. Before proceeding, connect an Ethernet cable to the camera's Ethernet connector. Do not use force or attempt to insert the connectors at an angle. Connect the other end of the cable to a router.

1 Select [ON] for [Wired LAN] in the network menu.

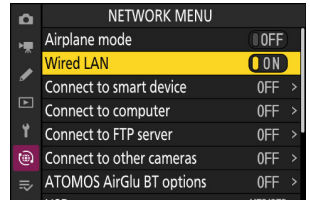

2 Select [Connect to other cameras] in the network menu, then highlight [Network settings] and press \odot .

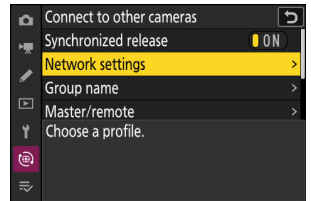

3 Highlight [Create profile] and press \odot .

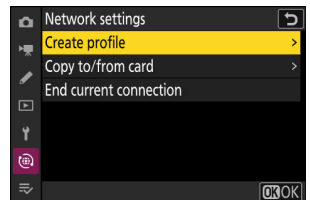

4 Name the new profile.

- To display IP address options without changing the default name, press \odot .
- Whatever name you choose will appear in the network menu [Connect to other cameras] > [Network settings] list.
- To rename the profile, press \odot . For information on text entry, see "Text Entry" ([71](#)). Press \odot to proceed after entering a name.

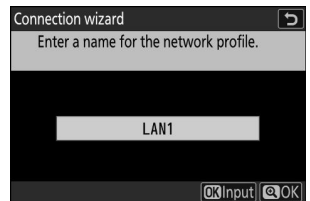

5 Obtain or select an IP address.

- Highlight one of the following options and press **OK**.

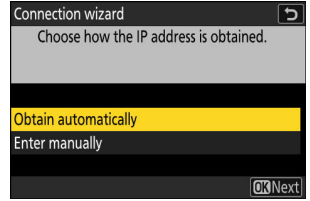

Option	Description
[Obtain automatically]	<p>Select this option if the network is configured to supply the IP address automatically. A "configuration complete" message will be displayed once an IP address has been assigned.</p> <ul style="list-style-type: none"> • It is recommended that you note the remote camera IP address, as you will need it in subsequent steps.
[Enter manually]	<p>Enter the IP address and sub-net mask manually.</p> <ul style="list-style-type: none"> • Press OK; you will be prompted to enter the IP address. • Rotate the main command dial to highlight segments. • Press Left or Right to change the highlighted segment and press OK to save changes. • Next, press OK; a "configuration complete" message will be displayed. Press OK again to display the sub-net mask. • Press Left or Right to edit the sub-net mask and press OK; a "configuration complete" message will be displayed.

- Press **OK** to proceed when the "configuration complete" message is displayed.
- The camera will initiate the connection. The profile name is displayed when a connection is established.

6 Highlight [Group name], press **OK**, and enter a group name.

Enter a group name for the synchronized cameras. Group names can be up to eight characters long.

- All master and remote cameras on the network must all be in the same group.

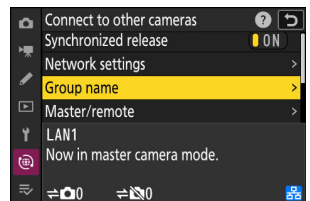

7 Highlight [Master/remote] and press .

Choose a role for each camera from “master” and “remote”.

- **[Master camera]:** Pressing the shutter-release button on the master camera releases the shutters on the remote cameras. Each group can have only one master. If the group has multiple master cameras, only the first to connect to the network will actually serve in that capacity.
- **[Remote camera]:** The shutters on the remote cameras are synchronized with the shutter on the master camera.

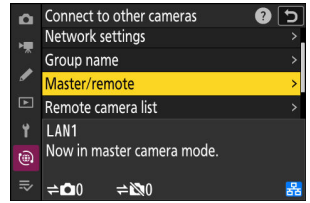

8 Repeat Steps 1 through 7 for the remaining cameras.

When configuring remote cameras, be sure to select **[Remote camera]** in Step 7.

9 On the master camera, highlight [Remote camera list] and press .

Cameras assigned the remote camera role in Step 7 are added to the master camera's remote camera list. The master camera can store information for up to 10 remote cameras in slots [01] through [10].

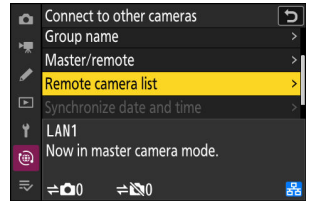

10 Highlight the desired slot and press .

Remote camera options will be displayed.

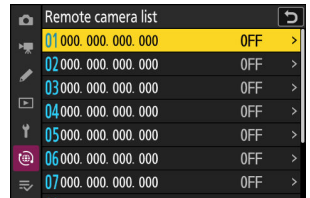



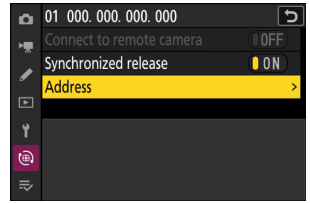

11 Highlight [Address] and press .

You will be prompted to enter an IP address.



12 Enter the remote camera IP address.

Enter the IP address you noted in Step 5.

- Rotate the main command dial to highlight segments.
- Press  or  to change the highlighted segment and press  to proceed.
- Press  to add the remote camera to the master camera remote camera list and establish a connection.

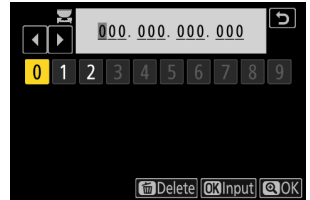

Tip: Viewing Remote Camera IP Addresses

To view a remote camera's IP address, select [**Connect to other cameras**] > [**Network settings**] in the camera's network menu, highlight a synchronized release host profile, press , and select [**TCP/IP**].

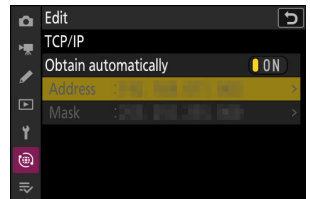

13 Add the remaining remote cameras.

- The master camera shows the number of cameras in the group currently connected or not connected.

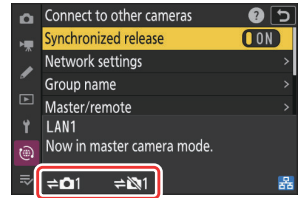

- A  icon appears in the master camera shooting display together with the number of remote cameras connected.

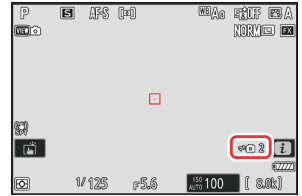

Connection Errors

In the event of remote camera connection errors, the remote camera count in the master camera shooting display will turn red and instead show the number of remote cameras that failed to connect.

14 Take pictures.

- Pressing the shutter-release button on the master camera releases the shutters on the remote cameras.

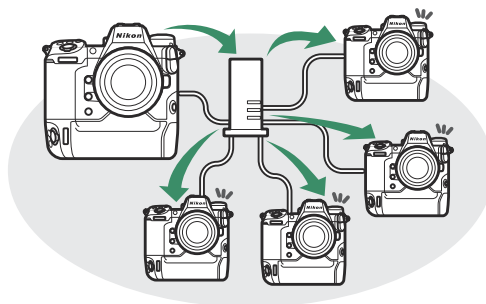

- Note that the standby timers will not expire automatically when the cameras are in synchronized release mode.

Tip: Suspending Synchronized Release

To temporarily disable synchronized release without ending the camera's connection to the network, select **[OFF]** for **[Connect to other cameras]** > **[Synchronized release]** in the network menu.

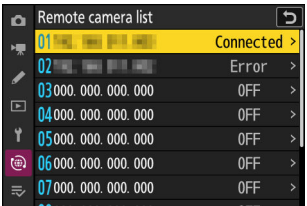

Tip: Viewing Remote Camera Status

To view remote camera status, highlight **[Remote camera list]** on the master camera and press .



Remote camera list		
01	Connected	>
02	Error	>
03	000.000.000.000	OFF >
04	000.000.000.000	OFF >
05	000.000.000.000	OFF >
06	000.000.000.000	OFF >
07	000.000.000.000	OFF >

- Remote cameras are identified by IP address.
- Remote camera status is displayed as follows:
 - **[Connected]**: Normal connection.
 - **[Busy]**: The camera is being controlled from another master camera.
 - **[Error]**: One of the following errors has been detected:
 - The remote camera standby timer has expired.
 - The remote camera is off.
 - The remote camera is not in the same group as the master camera.
 - The IP address is incorrect.
 - **[OFF]**: Either
 - no remote camera has been assigned to the slot, or
 - **[OFF]** is selected for **[Connect to remote camera]** on the camera in question.
- Highlighting a remote camera with the **[Connected]** label and pressing  displays the number of pictures awaiting upload from the camera via FTP, FTP connection status, the battery level, and the number of exposures remaining.
- The entries for the remote cameras previously used for synchronized release will show the time of the most recent shot.

- To edit remote camera settings from the master camera, highlight the camera in the remote camera list and press .
 - To temporarily suspend the connection to the selected camera, select **[OFF]** for **[Connect to remote camera]**.
 - To temporarily suspend synchronized release on the selected camera, select **[OFF]** for **[Synchronized release]**.
 - If desired, you can then edit the camera's IP address by highlighting **[Address]** and pressing . To reconnect, select **[ON]** for **[Connect to remote camera]**. No connection will be established if no remote camera exists at the specified address.
-

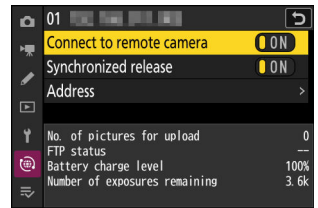

Synchronizing Camera Clocks

When the cameras are connected to the network using **[Connect to other cameras]** in the network menu, the clocks on all cameras in the current group connected can be set to the time and date reported by the master camera. Synchronization applies to all options in the setup menu **[Time zone and date]** display.

1 Connect the cameras to the network using **[Connect to other cameras]** > **[Network settings]** in the network menu.

For more information, see “Synchronized Release” ([📖 386](#)).

2 On the master camera, select **[Connect to other cameras]**, then highlight **[Synchronize date and time]** and press **↵**.

- Master camera clock settings will be displayed.
- **[Synchronize date and time]** is not available on the remote cameras.
- **[Synchronize date and time]** will not be available if no camera is connected to the network.

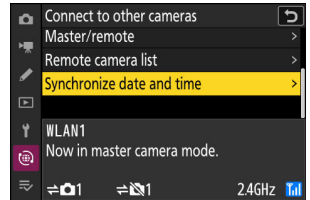

3 Press **⏏**.

- The clocks on the remote cameras will be set to the date and time reported by the master camera.
- A message will be displayed when the process is complete.
- Press **⏏** again to return to the **[Connect to other cameras]** display.

Flash Photography

“On-Camera” Versus “Remote”

You can take pictures using an optional flash unit mounted on the camera accessory shoe or one or more remote flash units.

- When using a flash, select **[OFF]** for **[Silent mode]** in the setup menu.

Camera-Mounted Flash Units

Take pictures using a flash unit mounted on the camera. See the following pages for more information ([book 404](#)).

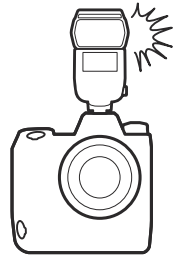

Remote Flash Photography

Take pictures with one or more remote flash units using wireless flash control (Advanced Wireless Lighting, or AWL). For more information, see “What Is Remote Flash Photography?” ([book 414](#)).

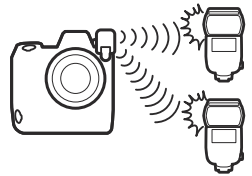

Using an On-Camera Flash

1 Mount a flash unit on the camera accessory shoe.

See the documentation supplied with each Speedlight for information on mounting the unit on the camera.

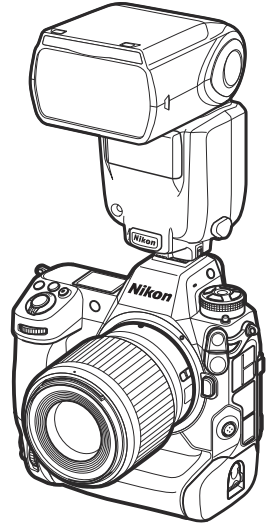

2 Turn on the camera and flash unit.

The flash will begin charging; the flash-ready indicator (⚡) will appear in the shooting display when charging is complete.

3 Choose the flash control mode ([📖 407](#)) and flash mode ([📖 409](#)).

4 Adjust shutter speed and aperture.

5 Take pictures.

✓ Shutter Speed

Shutter speed can be set as follows when an optional flash unit is used:

Shooting mode	Shutter speed
P, A	Set automatically by camera ($1/200$ s– $1/60$ s) *
S	$1/200$ s–30 s
M	$1/200$ s–30 s, Bulb, Time

* Shutter speed may be set as slow as 30 s if slow sync, slow rear-curtain sync, or slow sync with red-eye reduction is selected for flash mode.

✓ Caution: Third-Party Flash Units

The camera cannot be used with flash units that would apply voltages over 250 V to the camera's X contacts or short-circuit contacts on the accessory shoe. Use of such flash units could not only interfere with normal operation of the camera but also damage the flash sync circuits of the camera and/or flash.

i-TTL Flash Control

When an optional flash unit that supports the Nikon Creative Lighting System is attached and set to TTL, the camera uses monitor pre-flashes for balanced or standard “i-TTL fill-flash” flash control. i-TTL flash control is not available with flash units that do not support the Nikon Creative Lighting System. The camera supports the following types of i-TTL flash control:

Flash control	Description
i-TTL balanced fill-flash	The camera uses “i-TTL balanced fill-flash” flash control for a natural balance between the main subject and ambient background lighting. After the shutter-release button is pressed and immediately before the main flash, the flash unit emits a series of monitor pre-flashes which the camera uses to optimize flash output for a balance between the main subject and ambient background lighting.
Standard i-TTL fill-flash	Flash output is adjusted to bring lighting in the frame to a standard level; the brightness of the background is not taken into account. Recommended for shots in which the main subject is emphasized at the expense of background details, or when exposure compensation is used.

- Standard i-TTL fill-flash is activated automatically when [**Spot metering**] is selected.

Tip: The Sync Terminal

A sync cable can be connected to the sync terminal (which features a JIS-B locking nut) as required. Do not connect another flash unit via a sync cable when performing rear-curtain sync flash photography with a flash unit mounted on the camera accessory shoe.



Flash Control Mode

When a flash unit that supports unified flash control (an SB-5000, SB-500, SB-400, or SB-300; [link 408](#)) is mounted on the camera, the flash control mode, flash level, and other flash settings can be adjusted using the **[Flash control]** > **[Flash control mode]** item in the photo shooting menu. The flash control modes available vary with the flash used. The options available in the flash control display vary with the option selected for **[Flash control mode]**.

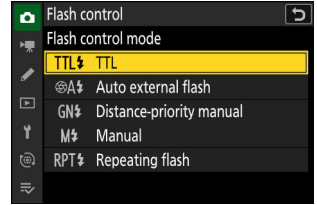

- Settings for flash units other than the SB-5000, SB-500, SB-400, and SB-300 can only be adjusted using flash unit controls.
- Settings for an SB-5000 mounted on the accessory shoe can also be adjusted using the controls on the flash unit.

Option	Description
[TTL]	<ul style="list-style-type: none">• Flash output is adjusted automatically in response to shooting conditions.• Output can be adjusted using [Flash compensation (TTL)].
[Auto external flash]	<ul style="list-style-type: none">• Light from the flash is reflected from the subject to an auto external flash sensor and flash output adjusted automatically.• Output can be adjusted using [Auto external flash compensation].• Auto external flash supports “auto aperture” ((A)) and “non-TTL auto” ((A)) modes. For details, see the documentation provided with the flash unit.
[Distance-priority manual]	<ul style="list-style-type: none">• Choose the distance to the subject; flash output will be adjusted automatically.• The distance to the subject is selected using [Distance-priority options] > [Distance], while flash output can be adjusted using [Flash compensation].
[Manual]	<ul style="list-style-type: none">• Choose the flash level manually.• Flash output is selected using [Manual output amount].

Option	Description
[Repeating flash]	<ul style="list-style-type: none">• The flash fires repeatedly while the shutter is open, producing a multiple-exposure effect.• Use [Repeating flash] > [Output] to adjust flash output and [Times] to choose the number of times the unit fires. [Frequency] controls how often the unit fires per second, measured in Hz.• The maximum number of times the flash will fire varies with [Output] and [Frequency]. For details, see the documentation provided with the flash unit.

Unified Flash Control



Unified flash control allows the camera and flash unit to share settings. Changes to flash settings made with either the camera or flash unit are reflected on both devices, as are changes made using optional Camera Control Pro 2 software. The flash unit must support unified flash control.

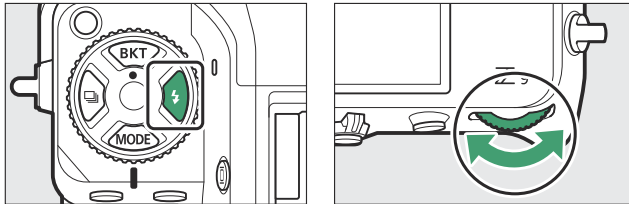

Flash Modes

To choose the flash mode, hold the  button and rotate the main command dial.



- The options available vary with the shooting mode.

Option		Description	Available in
	[Fill flash] (front-curtain sync)	This mode is recommended in most situations. In modes P and A , shutter speed will automatically be set to values between $\frac{1}{200}$ s (or $\frac{1}{8000}$ s with auto FP high-speed sync) and $\frac{1}{60}$ s.	P, S, A, M
	[Red-eye reduction]	Use for portraits. The flash will fire or the camera red-eye reduction lamp will light before the photograph is taken, reducing “red-eye”. <ul style="list-style-type: none"> • The desired results may not be achieved if the subject or camera moves before the shutter is released (this setting is not recommended with moving subjects or in other situations requiring a quick shutter response). 	P, S, A, M
	[Slow sync]	As for “fill flash”, except that shutter speed slows automatically to capture background lighting at night or under low light. <ul style="list-style-type: none"> • Note that photos may be prone to blurring due to camera shake at slow shutter speeds. • Use of a tripod is recommended. 	P, A

Option	Description	Available in
 [Slow sync + red-eye] (red-eye reduction with slow sync)	Use to include background lighting in portraits. Red-eye reduction is combined with slow shutter speeds to capture background lighting at night or under low light. <ul style="list-style-type: none"> Note that photos may be prone to blurring due to camera shake at slow shutter speeds. Use of a tripod is recommended. 	P, A
 [Rear-curtain sync]	The flash fires just before the shutter closes, creating the effect of a stream of light behind moving light sources. <ul style="list-style-type: none"> Selecting mode P or A after choosing this option sets the flash mode to slow sync. Note that photos may be prone to blurring due to camera shake at slow shutter speeds. Use of a tripod is recommended. 	P, S, A, M
 [Flash off]	The flash does not fire.	P, S, A, M

Studio Strobe Lighting

Rear-curtain sync may not correctly synchronize with studio flash systems.



Flash Compensation

Flash compensation is used to deliberately alter flash output, for example in order to change the brightness of the subject relative to the background. Flash output can be increased to make the main subject appear brighter, reduced to prevent glare, or otherwise fine-tuned to produce the desired result.

Adjusting Flash Compensation

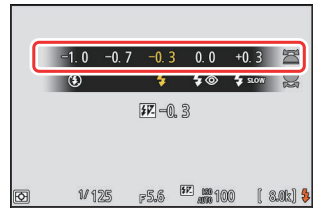
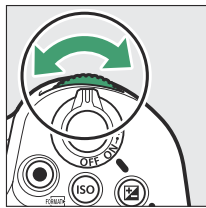
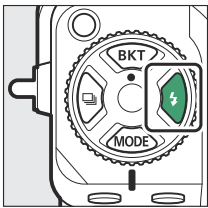
Hold the  button and rotate the sub-command dial.



- Choose from values of from -3 to $+1$ EV.
- At default settings, changes to flash output are made in increments of $\frac{1}{3}$ EV. The size of the increment can be selected using Custom Setting b2 **[EV steps for exposure ctrl]**.
- In general, choose positive values for brighter lighting, negative values to ensure that the subject is not too brightly lit.
- At values other than ± 0.0 , a  icon will appear in the shooting display and the control panel.
- Flash compensation can be viewed in the shooting display and control panel by pressing the  button.



Monitor

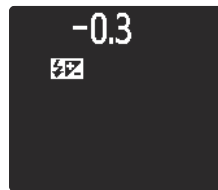

Control panel

- Normal flash output can be restored by setting flash compensation to ± 0.0 . Flash compensation is not reset when the camera is turned off.

FV Lock

This feature is used to lock flash output for optional CLS-compatible flash units, letting you take multiple photos or recompose shots without changing the flash level. Your subject need not be in the center of the frame, giving you more freedom when composing shots.

- Flash output is adjusted automatically for any changes in ISO sensitivity and aperture.

1 Assign [FV lock] to a control using Custom Setting f2 [Custom controls (shooting)].

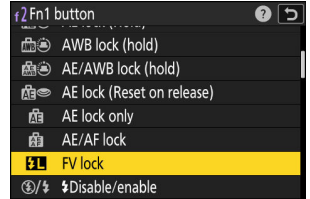

2 Mount a flash unit that supports FV lock on the camera accessory shoe.

3 Turn the flash unit on and choose a flash control mode of TTL or monitor pre-flash A or A .

- If you are using an SB-5000, SB-500, SB-400, or SB-300 mounted on the camera accessory shoe, choose [TTL] or [Auto external flash] for [Flash control] > [Flash control mode].
- For information on other flash units, see the documentation provided with the unit.

4 Focus.

Position the subject in the center of the frame and press the shutter-release button halfway to focus.

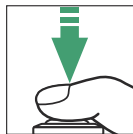

5 Lock flash level.

- After confirming that the flash-ready indicator (⚡) appears in the shooting display, press the **[FV lock]** control; the flash unit will emit a monitor pre-flash to determine the appropriate flash level.
- Flash output will lock and an FV lock icon (⚡L) will appear in the shooting display.



6 Recompose the shot.

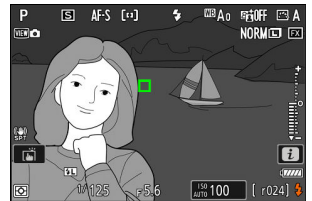

7 Press the shutter-release button the rest of the way down to shoot.

If desired, additional pictures can be taken without releasing FV lock. Repeat Steps 6 to 7 to take additional shots.



8 Release FV lock.

Press the **[FV lock]** control to release FV lock and confirm that the FV lock icon (⚡L) is no longer displayed in the shooting display.

Remote Flash Photography

What Is Remote Flash Photography?

Take pictures with one or more remote flash units using wireless flash control (Advanced Wireless Lighting, or AWL). For information on using a flash unit mounted on the camera accessory shoe, see “‘On-Camera’ Versus ‘Remote’” ([📖 403](#)).

Throughout this chapter, operations involving an accessory connected to the camera are indicated by , operations involving remote flash units by . For more information on using remote flash units () , see the documentation provided with the flash unit.

Using Remote Flash Units

Remote flash units can be controlled via:

- **radio signals** * ([📖 415](#)),

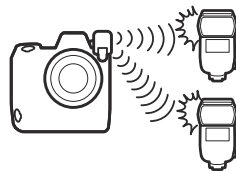

- **optical signals from a flash unit mounted on the camera accessory shoe** ([📖 426](#)), or

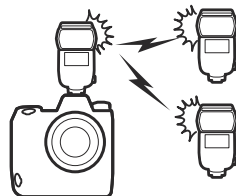

- **radio signals, with additional lighting provided by a shoe-mounted flash unit** * ([📖 425](#)).

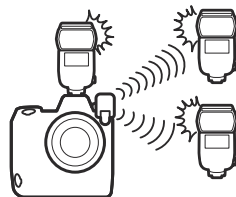

* Radio flash control is available only when a WR-R11a or WR-R10 is connected to the camera.

Radio AWL

Remote flash control provided via radio signals from a WR-R11a or WR-R10 connected to the camera is termed “radio Advanced Wireless Lighting”, or “radio AWL”. Radio AWL is available with SB-5000 flash units.

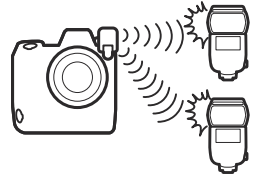

Establishing a Wireless Connection

Before using radio AWL, establish a wireless connection between the WR-R11a or WR-R10 and the remote flash units.

✓ The WR-R10 Wireless Remote Controller

- A WR-A10 adapter is required when using the WR-R10.
- Be sure to update the firmware for the optional WR-R10 wireless remote controller to version 3.0 or later before using radio AWL. Information on performing firmware updates is available via the Nikon website for your country or region.

1 📷: Connect the WR-R11a/WR-R10.

For more information, see the documentation provided with the WR-R11a/WR-R10.

2 📷: Select [Radio AWL] for [Flash control] > [Wireless flash options] in the photo shooting menu.

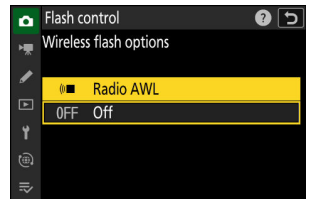

3 📷: **Choose a channel for the WR-R11a/WR-R10.**

Set the WR-R11a/WR-R10 channel selector to the desired channel.

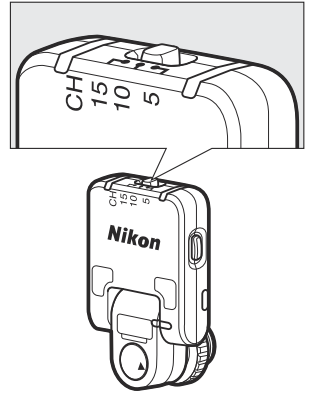

4 📷: **Choose a link mode for the WR-R11a/WR-R10.**

Select **[Wireless remote (WR) options]** > **[Link mode]** in the camera setup menu and choose from the following options:

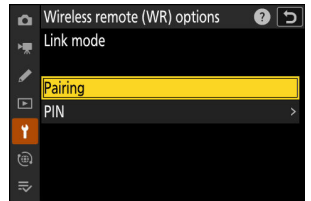

Option	Description
[Pairing]	<p>The camera connects only to devices with which it has previously been paired.</p> <ul style="list-style-type: none">• As camera will not communicate with devices with which it has not been paired, this option can be used to prevent signal interference from other devices in the vicinity.• Given that each device must be paired separately, however, PIN is recommended when connecting to a large number of devices.
[PIN]	<p>Communication is shared among all devices with the same four-digit PIN.</p> <ul style="list-style-type: none">• This option is a good choice for photography featuring a large number of remote devices.• If there are multiple cameras present that share the same PIN, the flash units will be under the sole control of the camera that connects first, preventing all other cameras from connecting (the LEDs on the WR-R11a/WR-R10 units connected to the affected cameras will blink).

5 : Establish a wireless connection between the WR-R11a/WR-R10 and the remote flash units.

- Set the remote units to radio AWL remote mode.
- Set the remote units to the channel you selected for the WR-R11a/WR-R10 in Step 3.
- Pair each of the remote units with the WR-R11a/WR-R10 according to the option selected in Step 4:
 - **[Pairing]**: Initiate pairing on the remote unit and press the WR-R11a/WR-R10 pairing button. Pairing is complete when the LINK lamps on the WR-R11a/WR-R10 and flash unit flash orange and green. Once a connection is established, the LINK lamp on the remote flash unit will light green.
 - **[PIN]**: Use the controls on the remote flash unit to enter the PIN you selected in the previous step. Pairing begins when the PIN is entered. Once a connection is established, the LINK lamp on the remote flash unit will light green.

6 : Repeat Step 5 for the remaining remote units.

7 : Confirm that the flash-ready lights for all flash units are lit.

In radio AWL, the flash-ready indicator will light in the camera shooting display when all flash units are ready.

✓ Listing Remote Flash Units

To view the flash units currently controlled using radio AWL, select **[Flash control]** > **[Radio remote flash info]** in the camera photo shooting menu.

- The identifier (remote flash unit name) for each unit can be changed using flash unit controls.

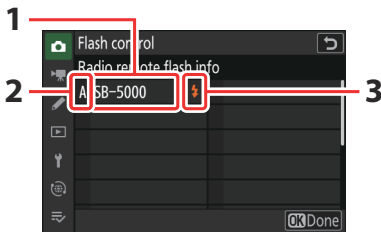

- 1 Connected flash unit
- 2 Group
- 3 Flash-ready indicator

✓ Reconnecting

As long as the channel, link mode, and other settings remain the same, the WR-R11a/WR-R10 will automatically connect to previously paired flash units when remote mode is selected on the flash unit, and Steps 3–6 can be omitted. The flash unit LINK lamp lights green when a connection is established.

Remote Flash Photography

Settings are adjusted using [Flash control] > [Remote flash control] in the photo shooting menu. Choose a remote flash control mode and take pictures as described below.

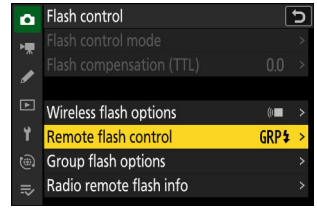



Group Flash

Select this item if you want to adjust settings separately for the flash units in each group.

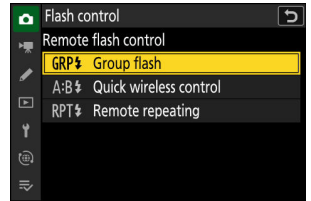
- 1  Select [Group flash] for [Flash control] > [Remote flash control].



- 2  Highlight [Group flash options] in the [Flash control] display and press .

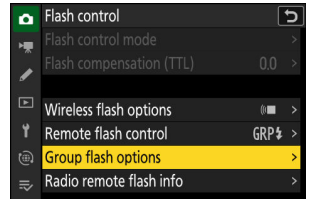

3 : Choose a flash control mode and flash level.

- Choose a flash control mode and flash level for the flash units in each group.

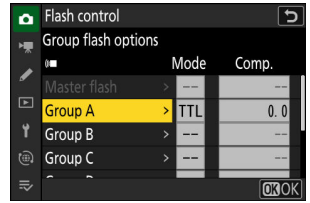



- The following options are available:

Option	Description
TTL	i-TTL flash control.
 A	Auto aperture. Available only with compatible flash units.
M	Choose the flash level manually.
— (off)	The remote units do not fire. [Comp.] cannot be adjusted.

4 : Group the remote flash units.

- Choose a group (A–F) for each of the remote flash units.
- The master flash can control up to 18 flash units in any combination.

5 / : Compose the shot and arrange the flash units.

- See the documentation provided with the flash units for more information.
- Test-fire the units and confirm that they are functioning normally. To test-fire the units, use the [**Test flash**] item in the  menu, which can be added to the menu using Custom Setting f1 [**Customize  menu**].

6 : Take the photograph.

Tip: Flash Info

Group flash options can be viewed using the **[Flash info]** item in the **i** menu, which can be added to the menu using Custom Setting f1 **[Customize **i** menu]**.

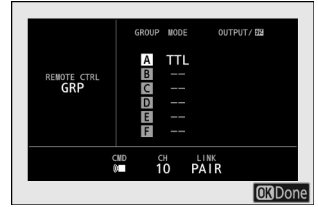

Quick Wireless Control

Select this item to control the relative balance between the remote flash units in groups A and B and adjust flash output for group C. Output for group C is adjusted manually.

- 1  Select **[Quick wireless control]** for **[Flash control]** > **[Remote flash control]**.

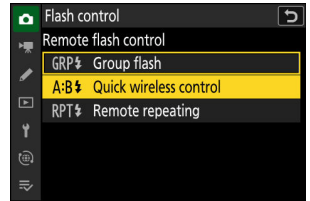

- 2  Highlight **[Quick wireless control options]** in the **[Flash control]** display and press **↻**.

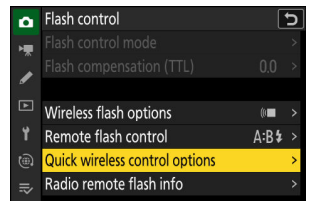

3 : Adjust quick wireless control settings.

- Choose the balance between groups A and B.

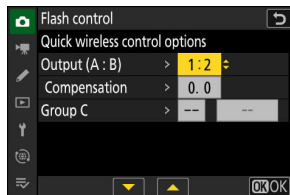

- Adjust flash compensation for groups A and B.

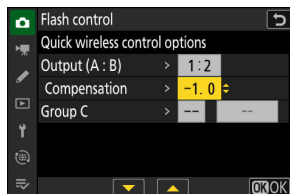

- Adjust settings for group C:

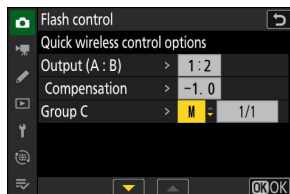

- Select [M] to enable or [—] to disable the units in group C.
- When [M] is selected, the units in group C will fire at the chosen output.



4 : Group the remote flash units.

- Choose a group (A, B, or C).
- The master flash can control up to 18 flash units in any combination.

5 / : Compose the shot and arrange the flash units.

- See the documentation provided with the flash units for more information.
- Test-fire the units and confirm that they are functioning normally. To test-fire the units, use the [Test flash] item in the  menu, which can be added to the menu using Custom Setting f1 [Customize  menu].

6 : Take the photograph.

Tip: Flash Info

Quick wireless control settings can be viewed using the [Flash info] item in the **i** menu, which can be added to the menu using Custom Setting f1 [Customize **i** menu].

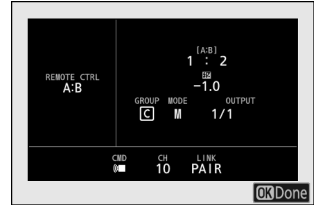

Remote Repeating

The flash units fire repeatedly while the shutter is open, producing a multiple-exposure effect.

- 1 Select [Remote repeating] for [Flash control] > [Remote flash control].

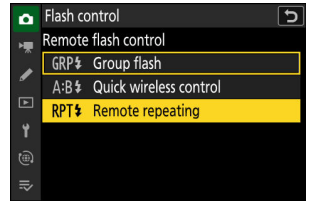

- 2 Highlight [Remote repeating options] in the [Flash control] display and press **OK**.

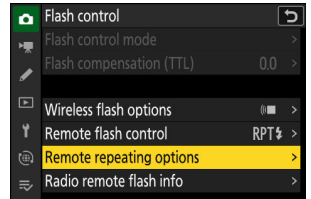

3 📷: Adjust remote repeating options.

- Adjust “output”, “times”, and “frequency”.

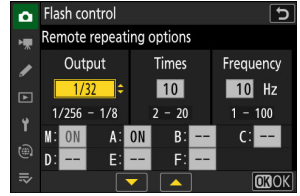

- Enable or disable selected groups.

- Select [ON] to enable or [---] to disable the selected group.

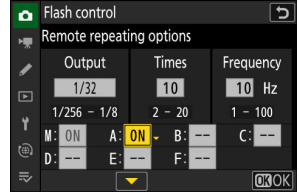

4 📷: Group the remote flash units.

- Choose a group (A–F) for each of the remote flash units.
- The master flash can control up to 18 flash units in any combination.

5 📷/🔧: Compose the shot and arrange the flash units.

- See the documentation provided with the flash units for more information.
- Test-fire the units and confirm that they are functioning normally. To test-fire the units, use the [Test flash] item in the **i** menu, which can be added to the menu using Custom Setting f1 [Customize **i** menu].

6 📷: Take the photograph.

Tip: Flash Info

Remote repeating options can be viewed using the [Flash info] item in the **i** menu, which can be added to the menu using Custom Setting f1 [Customize **i** menu].

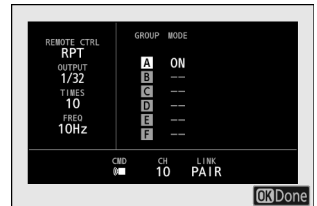

Adding a Shoe-Mounted Flash Unit

Radio-controlled flash units ([415](#)) can be combined with any of the following flash units mounted on the camera accessory shoe:

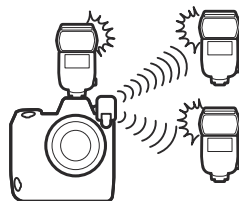

- SB-5000: Before attaching the flash unit, set it to radio-controlled master flash mode (a  icon will appear at the top left corner of the display) and choose group or remote-repeating flash control. Once the unit is attached, settings can be adjusted from the camera menus or using the controls on the SB-5000. In the case of the camera menus, use the options listed under **[Group flash options]** > **[Master flash]** or under **[M]** in the **[Remote repeating options]** display.
- SB-910, SB-900, SB-800, SB-700, SB-600: Configure the flash for standalone use. Use the controls on the flash unit to adjust flash settings.
- SB-500, SB-400, SB-300: Mount the unit on the camera. Adjust settings using the **[Group flash options]** > **[Master flash]** item in the camera menus.

Optical AWL

Remote flash units can be controlled via optical signals from an optional flash unit mounted on the camera accessory shoe and functioning as a master flash (optical AWL). For information on compatible flash units, see “Features Available with CLS-Compatible Flash Units” ([link 846](#)).

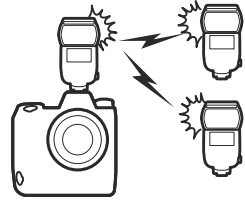

- If the flash unit in question is an SB-5000 or SB-500, settings can be adjusted from the camera. For more information, see “Using Optical AWL with the SB-5000 or SB-500” ([link 426](#)). See the documentation provided with the flash units for more information.
- Settings for other flash units must be adjusted using flash unit controls. For more information, see the documentation provided with the flash unit in question.

Using Optical AWL with the SB-5000 or SB-500

Mount the flash unit on the camera accessory shoe. Select [**Optical AWL**] for [**Flash control**] > [**Wireless flash options**] in the photo shooting menu and choose a remote flash control mode (the SB-500 supports only [**Group flash**]). Choose a remote flash control mode and take pictures as described below.

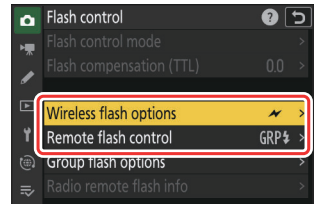

The SB-5000



When an SB-5000 is mounted on the camera accessory shoe, [**Flash control**] settings can also be changed using the controls on the flash unit.

Group Flash

Select this item if you want to adjust settings separately for the flash units in each group.

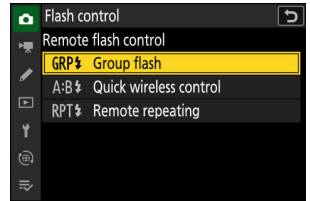
- 1  Select **[Group flash]** for **[Flash control]** > **[Remote flash control]**.



- 2  Highlight **[Group flash options]** in the **[Flash control]** display and press .

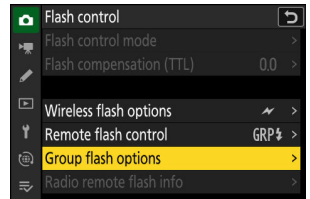

3  **Adjust flash output and choose the channel and flash control mode.**

- Choose the flash control mode and flash level for the master flash and the remote flash units in each group.

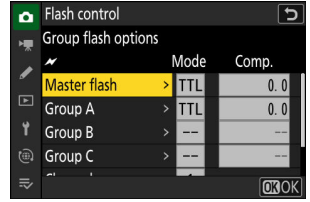

- The following options are available:

Option	Description
TTL	i-TTL flash control.
 A	Auto aperture. Available only with compatible flash units.
M	Choose the flash level manually.
— (off)	The remote units do not fire. [Comp.] cannot be adjusted.

- For **[Channel]**, choose the channel (1–4) the master flash will use for optical remote flash control.
- If the remote flash units include an SB-500, you must choose Channel **[3]**.

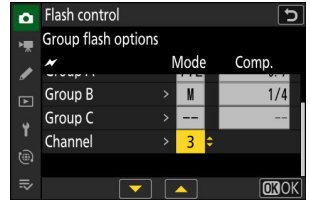

4  **Choose a channel for the remote flash units.**



Set the remote flash units to the channel selected for **[Channel]** in Step 3.

5  **Group the remote flash units.**

- Choose a group (A, B, or C).
- If you are using an SB-500 as the master flash, choose from groups A and B.
- There is no limit on the number of remote flash units that may be used. The practical maximum, however, is three per group, as the light emitted by the remote flash units will interfere with performance if more flash units are used.

6  : Compose the shot and arrange the flash units.

- See the documentation provided with the flash units for more information.
- Test-fire the units and confirm that they are functioning normally. To test-fire the units, use the [Test flash] item in the **i** menu, which can be added to the menu using Custom Setting f1 [Customize **i** menu].

7  : Take the photograph after confirming that the flash-ready lights for all flash units are lit.

Tip: Flash Info

Group flash options can be viewed using the [Flash info] item in the **i** menu, which can be added to the menu using Custom Setting f1 [Customize **i** menu].

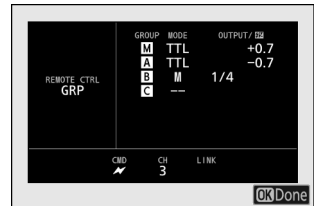



Quick Wireless Control (SB-5000 Only)

Select this item to control the relative balance between the remote flash units in groups A and B and adjust flash output for group C. Output for group C is adjusted manually.

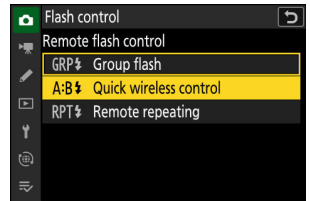
- 1  Select [Quick wireless control] for [Flash control] > [Remote flash control].



- 2  Highlight [Quick wireless control options] in the [Flash control] display and press .

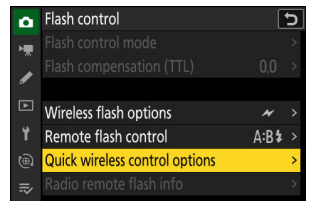

3 Adjust quick wireless control settings.

- Choose the balance between groups A and B.

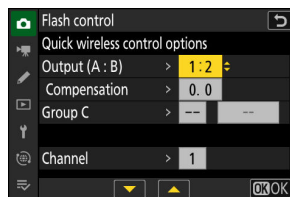

- Adjust flash compensation for groups A and B.

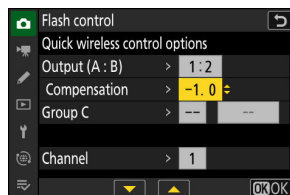

- Adjust settings for group C:

- Select **[M]** to enable or **[—]** to disable the units in group C.
- When **[M]** is selected, the units in group C will fire at the chosen output.

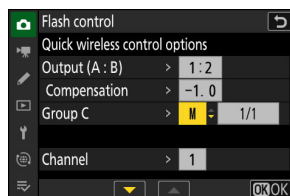

- Choose the channel.

- For **[Channel]**, choose the channel (1–4) the master flash will use for optical remote flash control.
- If the remote flash units include an SB-500, you must choose Channel **[3]**.

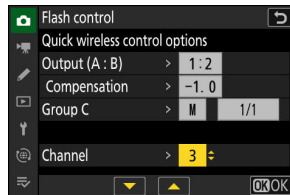

4 Choose a channel for the remote flash units.

Set the remote flash units to the channel selected for **[Channel]** in Step 3.

5 Group the remote flash units.

- Choose a group (A, B, or C).
- There is no limit on the number of remote flash units that may be used. The practical maximum, however, is three per group, as the light emitted by the remote flash units will interfere with performance if more flash units are used.

6 : Compose the shot and arrange the flash units.

- See the documentation provided with the flash units for more information.
- Test-fire the units and confirm that they are functioning normally. To test-fire the units, use the [Test flash] item in the **i** menu, which can be added to the menu using Custom Setting f1 [Customize **i** menu].

7 : Take the photograph after confirming that the flash-ready lights for all flash units are lit.

Tip: Flash Info

Quick wireless control settings can be viewed using the [Flash info] item in the **i** menu, which can be added to the menu using Custom Setting f1 [Customize **i** menu].

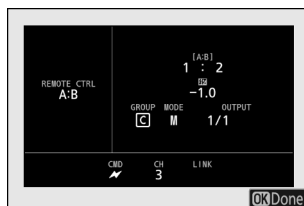

Remote Repeating (SB-5000 Only)

The flash units fire repeatedly while the shutter is open, producing a multiple-exposure effect.

- 1  Select [Remote repeating] for [Flash control] > [Remote flash control].

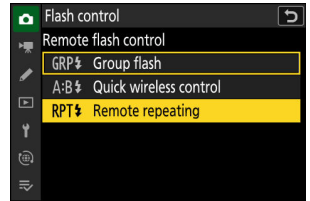

- 2  Highlight [Remote repeating options] in the [Flash control] display and press .

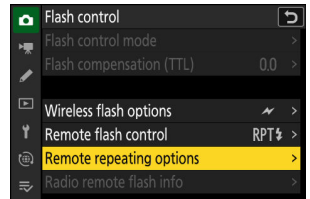

3 Adjust remote repeating options.

- Adjust “output”, “times”, and “frequency”.

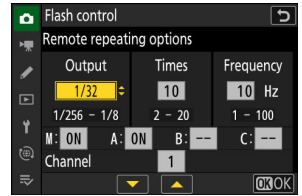

- Enable or disable selected groups.

- Select [ON] to enable or [--] to disable the selected group.

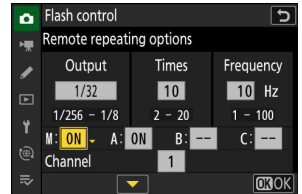

- Choose the channel.

- For [Channel], choose the channel (1–4) the master flash will use for optical remote flash control.
- If the remote flash units include an SB-500, you must choose Channel [3].

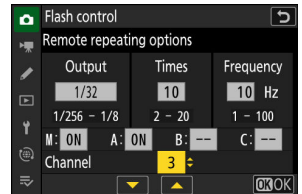

4 Choose a channel for the remote flash units.

Set the remote flash units to the channel selected for [Channel] in Step 3.

5 Group the remote flash units.

- Choose a group (A, B, or C).
- There is no limit on the number of remote flash units that may be used. The practical maximum, however, is three per group, as the light emitted by the remote flash units will interfere with performance if more flash units are used.

6 : Compose the shot and arrange the flash units.

- See the documentation provided with the flash units for more information.
- Test-fire the units and confirm that they are functioning normally. To test-fire the units, use the **[Test flash]** item in the **i** menu, which can be added to the menu using Custom Setting f1 **[Customize  menu]**.

7 : Take the photograph after confirming that the flash-ready lights for all flash units are lit.

Optical AWL

- Position the sensor windows on the remote flash units to pick up the light from the master flash. Particular care is required if the master flash is mounted on a hand-held camera.
 - Be sure that direct light or strong reflections from the remote flash units do not enter the camera lens (in **[TTL]** mode) or the photocells on the remote flash units (**[⊗A]** mode). Otherwise light from the flash units may interfere with exposure.
 - Even if **[--]** is selected for **[Master flash] > [Mode]**, the master flash may emit low-intensity timing flashes. These flashes may appear in photographs taken at short range. This can be prevented by choosing low ISO sensitivities or small apertures (high f-numbers).
 - After positioning the remote flash units, take a test shot and view the results in the camera display.
-

Tip: Flash Info

Remote repeating options can be viewed using the **[Flash info]** item in the **i** menu, which can be added to the menu using Custom Setting f1 **[Customize  menu]**.

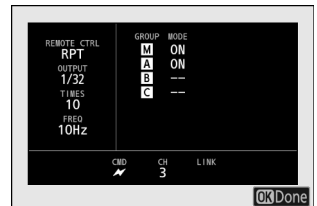

The Photo Shooting Menu: Shooting Options

The Photo Shooting Menu

To view the photo shooting menu, select the  tab in the camera menus.

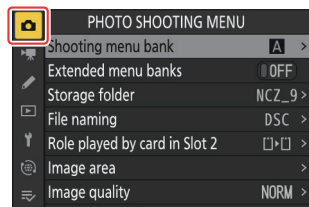

The options available in the photo shooting menu are listed below, together with their default settings.

- **[Shooting menu bank]:** A
- **[Extended menu banks]:** OFF
- **[Storage folder]**
 - **[Rename]:** NCZ_9
 - **[Select folder by number]:** 100
 - **[Select folder from list]:** —
- **[File naming]:** DSC
- **[Role played by card in Slot 2]:** Overflow
- **[Image area]**
 - **[Choose image area]:** FX (36×24)
 - **[DX crop alert]:** OFF
- **[Image quality]:** JPEG normal
- **[Image size settings]**
 - **[Image size]:** Large
 - **[Enable DX image sizes]:** OFF
 - **[Image size (DX)]:** Large
- **[RAW recording]:** High efficiency★
- **[ISO sensitivity settings]**
 - **[ISO sensitivity]:** 100
 - **[Auto ISO sensitivity control]:** ON
 - **[Maximum sensitivity]:** 25600
 - **[Maximum sensitivity with ]:** Same as without flash
 - **[Minimum shutter speed]:** Auto
- **[White balance]:** Auto: Keep white (reduce warm colors)
- **[Set Picture Control]:** Auto

- **[Manage Picture Control]**: —
- **[Color space]**: sRGB
- **[Active D-Lighting]**: Off
- **[Long exposure NR]**: OFF
- **[High ISO NR]**: Normal
- **[Vignette control]**: Normal
- **[Diffraction compensation]**: ON
- **[Auto distortion control]**: ON
- **[Photo flicker reduction]**: OFF
- **[High-frequency flicker reduction]**: Off
- **[Metering]**: Matrix metering
- **[Flash control]**
 - **[Flash control mode]**: TTL
 - **[Wireless flash options]**: Off
 - **[Remote flash control]**: Group flash
- **[Focus mode]**: Single AF
- **[AF-area mode]**: Single-point AF
- **[AF subject detection options]**: Auto
- **[Vibration reduction]**: Sport
- **[Auto bracketing]**
 - **[Auto bracketing set]**: AE & flash bracketing
 - **[Number of shots]**: 0
 - **[Increment]**: 1.0
- **[Multiple exposure]**
 - **[Multiple exposure mode]**: Off
 - **[Number of shots]**: 2
 - **[Overlay mode]**: Average
 - **[Save individual pictures (RAW)]**: ON
 - **[Overlay shooting]**: ON
 - **[Select first exposure (RAW)]**: —
- **[HDR overlay]**
 - **[HDR mode]**: Off
 - **[HDR strength]**: Auto
 - **[Save individual pictures (RAW)]**: OFF
- **[Interval timer shooting]**
 - **[Choose start day/time]**: Now
 - **[Interval]**: 1 min.
 - **[Intervals×shots/interval]**: 0001×1
 - **[Exposure smoothing]**: ON
 - **[Interval priority]**: OFF
 - **[Focus before each shot]**: OFF
 - **[Options]**: Off
 - **[Starting storage folder]**

- [New folder]:
- [Reset file numbering]:
- [Time-lapse video]
 - [Interval]: 5 s
 - [Shooting time]: 25 min.
 - [Exposure smoothing]: ON
 - [Choose image area]: FX
 - [Video file type]: H.265 8-bit (MOV)
 - [Frame size/frame rate]: 3840×2160; 30p
 - [Interval priority]: OFF
 - [Focus before each shot]: OFF
 - [Destination]: Slot 1
- [Focus shift shooting]
 - [No. of shots]: 100
 - [Focus step width]: 5
 - [Interval until next shot]: 0
 - [First-frame exposure lock]: ON
 - [Focus position auto reset]: OFF
 - [Starting storage folder]
 - [New folder]:
 - [Reset file numbering]:

Shooting Menu Bank

MENU button → photo shooting menu

Photo shooting and video recording menu options are stored in one of four banks (banks "A" through "D") that can be selected using **[Shooting menu bank]**. With the exceptions noted below, changes to settings made while one bank is selected are not applied to the remaining banks.

- Changes to the following photo shooting menu settings apply to all banks:
 - **[Extended menu banks]**
 - **[White balance]** presets
 - **[Multiple exposure]**
 - **[Interval timer shooting]**
 - **[Time-lapse video]**
 - **[Focus shift shooting]**
- Changes to the following video recording menu setting also apply to all banks:
 - **[Extended menu banks]**
- Shooting menu banks can also be edited via the **[Shooting menu bank]** item in the video recording menu. Changes made in the photo shooting menu apply in the video recording menu and vice versa.

Tip: Shooting Menu Banks

The control panel shows the current menu bank ("A", "B", "C", or "D").

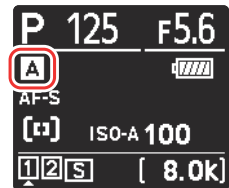

Renaming Shooting Menu Banks

A descriptive caption can be added to the bank name ("A", "B", "C", or "D") by highlighting the bank, pressing **OK**, and selecting **[Rename]**. Captions can be up to 20 characters long.

Copying Shooting Menu Banks

To create a copy of a shooting menu bank, highlight the bank, press **OK**, select **[Copy]**, and choose a destination for the copy.

Restoring Default Settings

You can restore default settings for a selected shooting menu bank. To do so, highlight the bank and press **OK**; a confirmation dialog will be displayed. Highlight **[Yes]** and press **OK** to restore default settings for the selected bank.

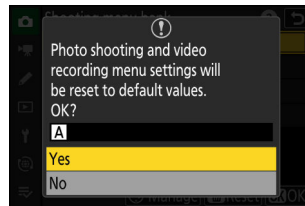
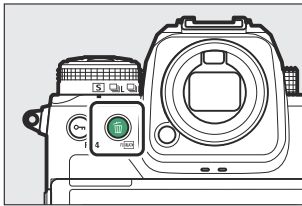

- Shooting menu banks cannot be reset while a multiple exposure is in progress.
- **[Storage folder]** and **[Manage Picture Control]** are not reset.

Extended Menu Banks

MENU button ➡📷 photo shooting menu

Select **[ON]** to include exposure settings in the information recorded in each of the four shooting menu banks.

- Changes to exposure settings will be stored in the bank currently selected for **[Shooting menu bank]**. The settings stored in the bank will be recalled the next time the bank is selected.
- The additional settings stored in extended banks for use in photo mode are:
 - shooting mode,
 - shutter speed (modes **S** and **M** only),
 - aperture (modes **A** and **M** only), and
 - flash mode.
- The additional settings stored in extended banks for use in video mode are:
 - shooting mode,
 - shutter speed (mode **M** only), and
 - aperture (modes **A** and **M** only).
- Selecting **[OFF]** restores the shooting and flash modes, shutter speed, and aperture in effect before **[ON]** was selected.
- Exposure settings can also be edited via the **[Extended menu banks]** item in the video recording menu. Changes made in the photo shooting menu apply in the video recording menu and *vice versa*.

Storage Folder

MENU button → photo shooting menu

Choose the folder in which subsequent pictures will be stored.

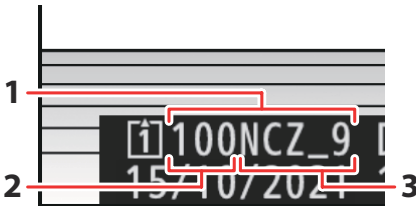

- 1 Folder
- 2 Folder number
- 3 Folder name

"Storage Folder"

Changes to [**Storage folder**] made in the photo shooting menu apply in the video recording menu and *vice versa*.

Renaming Folders

The default folder name, which appears after the folder number, is "NCZ_9". To choose a different five-character folder name for new folders, select [**Rename**].

- Existing folders cannot be renamed.
- If desired, the default name can be restored for subsequent folders by pressing and holding the  (**FNZ**) button while the keyboard is displayed.

Select Folder by Number

The folder in which subsequent pictures will be stored can be selected by number. If a folder with the specified number does not already exist, a new folder will be created.

1 Choose [Select folder by number].

- Highlight **[Select folder by number]** and press **[OK]** to display the **[Select folder by number]** dialog.
- The card on which the new folder will be created is underlined in the card slot display area at the top right corner of the **[Select folder by number]** dialog. The card used for new folders depends on the option currently selected for **[Role played by card in Slot 2]** in the photo shooting menu.

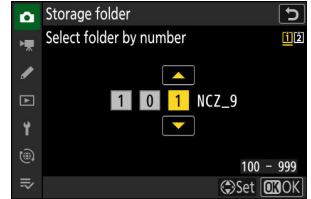

2 Choose a folder number.

- Press **[Left]** or **[Right]** to highlight digits.
- To change the highlighted digit, press **[Up]** or **[Down]**.

3 Save changes and exit.

- If a folder with the selected number already exists, a **[Empty]**, **[Full]**, or **[Partially Full]** icon will be displayed to the left of the folder number. Press **[OK]** to complete the operation and return to the main menu; if you chose a folder marked **[Empty]** or **[Full]**, it will be selected as the folder for new pictures.
- If you chose a folder number that does not already exist, a new folder will be created with that number when you press **[OK]**.
- In either case, subsequent pictures will be stored in the chosen folder.
- To exit without changing the storage folder, press the **MENU** button.

✓ Folder Icons

Folders in the **[Select folder by number]** dialog are shown by **[Empty]** if empty, by **[Full]** if full (containing either 5000 pictures or a picture numbered 9999), or by **[Partially Full]** if partially full. A **[Full]** icon indicates that no further pictures can be stored in the folder.

Select Folder from List

To choose from a list of existing folders:

1 Choose [Select folder from list].

Highlight [Select folder from list] and press \odot to display the [Select folder from list] dialog.

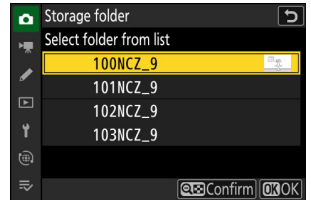

2 Highlight a folder.

Press \odot or \odot to highlight a folder.

3 Select the highlighted folder.

- Press \otimes to select the highlighted folder and return to the main menu.
- Subsequent photographs will be stored in the selected folder.

✔ **Cautions: Folder and File Numbers**

- When the current folder number reaches 999, the camera will no longer be able to create new folders and the shutter release will be disabled if:
 - the current folder contains 5000 pictures (in addition, video recording will be disabled if the camera calculates that the number of files needed to record a video of the maximum length would result in the folder containing over 5000 files), or
 - the current folder contains a picture numbered 9999 (in addition, video recording will be disabled if the camera calculates that the number of files needed to record a video of the maximum length would result in a file numbered over 9999).
- If there is space on the memory card, you will nevertheless be able to continue shooting by:
 - creating a folder with a number less than 999 and selecting it as the storage folder, or
 - changing the options selected for **[Frame size/frame rate]** or **[Video file type]** before recording videos.

✔ **Startup Time**

Additional time may be required for camera startup if the memory card contains a very large number of files or folders.

File Naming

MENU button ➡ 📷 photo shooting menu

Pictures are saved using file names consisting of "DSC_" followed by a four-digit number and a three-letter extension. **[File naming]** is used to select three letters to replace the "DSC" portion of the file name. For information on text entry, see "Text Entry" ([📖 71](#)).





✔ File Names

- File names take the form "DSC_nnnn.xxx", where nnnn is a number from 0001 to 9999 and xxx is one of the following extensions, assigned according to the options selected for image quality and file type:
 - NEF: NEF (RAW) photos
 - JPG: JPEG (fine, normal, or basic) photos
 - MOV: MOV videos
 - NEV: NEV videos
 - MP4: MP4 videos
 - NDF: Dust off reference data
 - Pictures created with **[Adobe RGB]** selected for **[Color space]** in the photo shooting menu have file names of the form "_DSCnnnn.xxx".
 - In each pair of photographs recorded at image-quality settings of RAW + JPEG, the NEF (RAW) and JPEG pictures have the same file names but different extensions.
 - Proxy videos have the same file names as the RAW footage with which they are recorded, but while the RAW footage is assigned the extension ".NEV" or ".MOV", the proxy files have the extension ".MP4".
-

Role Played by Card in Slot 2

MENU button → photo shooting menu

Choose the role played by the card in Slot 2 when two memory cards are inserted in the camera.

Option		Description
	[Overflow]	The card in Slot 2 is used only when the card in Slot 1 is full.
	[Backup]	Each picture is recorded twice, once to the card in Slot 1 and again to the card in Slot 2.
	[RAW Slot 1 - JPEG Slot 2]	<ul style="list-style-type: none"> • NEF (RAW) copies of photos taken at settings of RAW + JPEG are recorded only to the card in Slot 1, JPEG copies only to the card in Slot 2. • Pictures taken at other image quality settings are recorded twice at the same setting, once to the card in Slot 1 and again to the card in Slot 2.
	[JPEG Slot 1 - JPEG Slot 2]	<ul style="list-style-type: none"> • Two JPEG copies are recorded, one to each memory card. • The copy saved to the card in Slot 1 is recorded at the image quality and size selected via the QUAL button or photo shooting menu. The copy saved to the card in Slot 2 is saved at an image quality of [JPEG basic] and a size of either [Medium] or [Small]. The size can be selected by pressing  when [JPEG Slot 1 - JPEG Slot 2] is highlighted. • At image qualities of RAW or RAW + JPEG, this option is equivalent to [Backup].

✓ Caution: [RAW Slot 1 - JPEG Slot 2]

If **[ON]** is selected for **[Multiple exposure]** > **[Save individual pictures (RAW)]** in the photo shooting menu, or if **[ON]** is selected for **[HDR overlay]** > **[Save individual pictures (RAW)]** in the photo shooting menu, unprocessed copies of the individual NEF (RAW) photos that make up each multiple exposure or HDR picture will be recorded to both memory cards together with the JPEG composite, regardless of the option selected for image quality.

Tip: [Backup], [RAW Slot 1 - JPEG Slot 2], and [JPEG Slot 1 - JPEG Slot 2]

- The shooting display and control panel show the number of exposures remaining on the card with the least amount of space available.
- The shutter release is disabled when either card is full.

Tip: Viewing Dual-Format Photos





- Use the **[Dual-format recording PB slot]** item in the playback menu to choose the slot from which dual-format photos are played back.
- When viewing dual-format photos, you can view the other copy using **[Jump to copy on other card]** in the **⌂** menu.

Tip: Recording Videos

The slot to which videos are recorded is selected using **[Destination]** in the video recording menu.

Deleting Copies

When deleting pictures recorded using **[Backup]**, **[RAW Slot 1 -JPEG Slot 2]**, or **[JPEG Slot 1 - JPEG Slot 2]**, you have the choice of erasing either both copies or only the copy on the card in the current slot.

- Pressing  when a picture created using either of these options is highlighted during playback displays a confirmation message.
- To delete only the copy on the card in the current slot, highlight **[Selected picture]** and press  again.
- To delete both copies, highlight **[Same pictures on [1] and [2]]** and press .
- If a voice memo is appended to the picture, a confirmation dialog will be displayed. To delete only the voice memo, highlight **[Voice memo only]** and press .

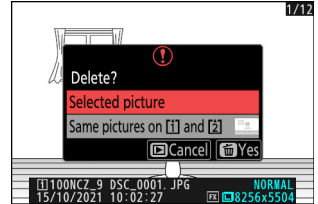

Tip: Delete Options

Use the **[Delete pictures from both slots]** item in the playback menu to choose the options displayed when a picture is deleted.

Image Area

MENU button ➡ 📷 photo shooting menu

Adjust image area settings. For more information, see “Adjusting Image Area Settings” ([📖 104](#)), part of the section on “Image Recording Options (Image Area, Quality, and Size)” in the “Shooting Settings” chapter.

Image Quality

MENU button ➡ 📷 photo shooting menu

Choose a file format for photographs. For more information, see “Adjusting Image Quality” ([book 106](#)), part of the section on “Image Recording Options (Image Area, Quality, and Size)” in the “Shooting Settings” chapter.

Image Size Settings

MENU button ➡  photo shooting menu

Choose the size, in pixels, of pictures recorded with the camera. For more information, see “Adjusting Image Size Settings” ([📖 108](#)), part of the section on “Image Recording Options (Image Area, Quality, and Size)” in the “Shooting Settings” chapter.

RAW Recording

MENU button ➡️📷 photo shooting menu

Choose a compression type for NEF (RAW) photographs. In descending order by the size of the files produced, the options are: [**Lossless compression**], [**High efficiency★**], and [**High efficiency**].

- [**High efficiency★**] produces pictures that compare favorably in quality to those produced by [**Lossless compression**] and are higher in quality than those produced by [**High efficiency**].

ISO Sensitivity Settings

MENU button →  photo shooting menu

Adjust ISO sensitivity settings for photographs.

Option	Description
[ISO sensitivity]	Choose from settings of ISO 64 to 25600; the camera also supports settings below ISO 64 by about 0.3, 0.7, and 1 EV (ISO 32 equivalent) and above ISO 25600 by about 0.3, 0.7, 1, and 2 EV (ISO 102400 equivalent).
[Auto ISO sensitivity control]	Select [ON] to enable auto ISO sensitivity control. If [OFF] is selected, [ISO sensitivity] will remain fixed at the value selected by the user. [Maximum sensitivity], [Maximum sensitivity with $\frac{1}{2}$], and [Minimum shutter speed] options are available when [ON] is selected.
[Maximum sensitivity]	Choose an upper limit for ISO sensitivity to prevent it being raised too high.
[Maximum sensitivity with $\frac{1}{2}$]	Choose the upper ISO sensitivity limit for photos taken using an optional flash unit.
[Minimum shutter speed]	<p>Choose the shutter speed below which auto ISO sensitivity control will kick in to prevent underexposure in modes P and A; options range from $\frac{1}{16,000}$ to 30 s. If [Auto] is selected, the camera will choose the minimum shutter speed based on lens focal length. For example, the camera will automatically choose faster minimum shutter speeds to prevent blur caused by camera shake when a long lens is attached.</p> <ul style="list-style-type: none">• To view auto shutter-speed selection options, highlight [Auto] and press . Auto shutter-speed selection can be fine-tuned by choosing faster or slower minimums. Faster settings can be used to reduce blur when photographing fast-moving subjects.• Shutter speeds may drop below the selected minimum if optimal exposure cannot be achieved at the ISO sensitivity chosen for [Maximum sensitivity].

White Balance

MENU button ➡ 📷 photo shooting menu

Adjust white balance to match the color of the light source. For more information, see “White Balance” ([📖 151](#)) in the “Shooting Settings” chapter.

Set Picture Control

MENU button ➡ 📷 photo shooting menu

Choose image processing (“Picture Control”) options for new photos according to the scene or your creative intent. For more information, see “Picture Controls” ([📖 183](#)) in the “Shooting Settings” chapter.

Manage Picture Control

MENU button ➡ 📷 photo shooting menu

Save modified Picture Controls as custom Picture Controls. For more information, see “Custom Picture Controls” ([📖 189](#)) in the “Picture Controls” section of the “Shooting Settings” chapter.

Color Space

MENU button ➡ 📷 photo shooting menu

The color space determines the gamut of colors available for color reproduction. [sRGB] is recommended for general-purpose printing and display. With a broader gamut of colors than [sRGB], [Adobe RGB] is a better choice for professional publication and commercial printing.

✔ Caution: Color Space

The selected color space may be overwritten when pictures are opened in third-party software. NX Studio can open pictures in the color space selected on the camera.

✔ Adobe RGB

For accurate color reproduction, Adobe RGB pictures require applications, displays, and printers that support color management.

Active D-Lighting

MENU button → photo shooting menu

Preserve details in highlights and shadows, creating pictures with natural contrast. Use for high-contrast scenes, for example when photographing brightly-lit outdoor scenery through a door or window or taking pictures of shaded subjects on a sunny day. Active D-Lighting is most effective when used with matrix metering.



[Off]



[A Auto]

Option		Description
☞A	[Auto]	The camera automatically adjusts Active D-Lighting in response to shooting conditions.
☞H2	[Extra high 2]	Choose the amount of Active D-Lighting performed from (in order from high to low) [Extra high 2], [Extra high 1], [High], [Normal], and [Low].
☞H1	[Extra high 1]	
☞H	[High]	
☞N	[Normal]	
☞L	[Low]	
☞OFF	[Off]	Active D-Lighting off.

The option currently selected is shown by an icon in the display during shooting.

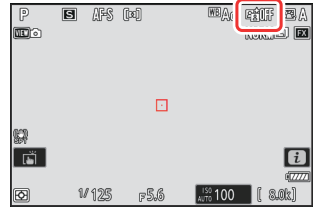

✓ Cautions: Active D-Lighting

- “Noise” in the form of randomly-spaced bright pixels, fog, or lines may appear in photos taken with Active D-Lighting.
 - In mode **M**, [AF-A **Auto**] is equivalent to [AF-N **Normal**].
 - Uneven shading may be visible with some subjects.
 - This function does not apply at high ISO sensitivities (Hi 0.3–Hi 2.0), including high sensitivities selected via auto ISO sensitivity control.
-

Long Exposure NR

MENU button → photo shooting menu

Select **[ON]** to reduce “noise” (bright spots or fog) in photographs taken at shutter speeds slower than 1 s.

- Long-exposure noise reduction is performed after the photo is taken. During processing, the message, “[**Performing noise reduction**]” will appear in the shooting display and “**Job NR**” will flash in the control panel. Pictures cannot be taken until the message has cleared from the display. The time required to process photos after shooting roughly doubles.

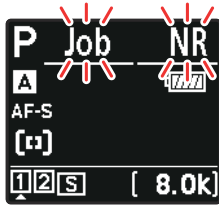

Control panel

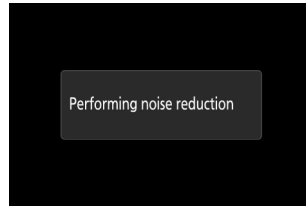

Monitor

- If “Bulb”, “Time”, or a setting slower than 30 s is selected for shutter speed, a timer will be displayed in the control panel when shooting ends showing the time remaining until processing is complete.

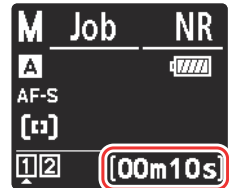

✓ Caution: Long-Exposure Noise Reduction

If the camera is turned off before processing is complete, the picture will be saved but noise reduction will not be performed.

High ISO NR

MENU button ➡️ photo shooting menu

Photographs taken at high ISO sensitivities can be processed to reduce “noise” (randomly-spaced bright pixels).

Option	Description
[High]	Reduce noise in photographs taken at all ISO sensitivities. The higher the sensitivity, the greater the effect. Choose the amount of noise reduction performed from (in order from high to low) [High], [Normal], and [Low].
[Normal]	
[Low]	
[Off]	Noise reduction is performed only as required. The amount of noise reduction performed is always lower than when [Low] is selected.

Vignette Control

MENU button ➡ 📷 photo shooting menu

Vignette control reduces “vignetting”—a drop in brightness at the edges of a photograph—by an amount that varies from lens to lens. Its effects are most noticeable at maximum aperture.

Option		Description
<input type="checkbox"/> H	[High]	Choose the amount of vignette control performed from (in order from high to low) [High], [Normal], and [Low].
<input type="checkbox"/> N	[Normal]	
<input type="checkbox"/> L	[Low]	
[Off]		Vignette control disabled.

✔ Caution: Vignette Control

Depending on the scene, shooting conditions, and type of lens, JPEG pictures may exhibit “noise” (fog) or over- or under-exposure at the edge of the frame that introduces variations in peripheral brightness. In addition, custom Picture Controls and preset Picture Controls that have been modified from default settings may not produce the desired effect. Take test shots and view the results in the monitor.

✔ Vignette Control

Changes to [Vignette control] in the photo shooting menu apply in the video recording menu and *vice versa*.

Diffraction Compensation

MENU button →  photo shooting menu

Select **[ON]** to reduce diffraction at small apertures (high f-numbers).

Diffraction Compensation

Changes to **[Diffraction compensation]** in the photo shooting menu apply in the video recording menu and *vice versa*.

Auto Distortion Control

MENU button →  photo shooting menu

Select **[ON]** as required to reduce barrel distortion when shooting with wide-angle lenses and to reduce pin-cushion distortion when shooting with long lenses. Note that **[ON]** may be selected automatically with some lenses, in which case this item will be grayed out and unavailable.

Auto Distortion Control

Changes to **[Auto distortion control]** in the photo shooting menu apply in the video recording menu and *vice versa*.

Photo Flicker Reduction

MENU button ➡ 📷 photo shooting menu

Selecting **[ON]** reduces the effects of flicker from such light sources as fluorescent or mercury-vapor lamps.

- Flicker can cause uneven exposure or (in photographs taken in continuous release modes) inconsistent exposure or coloration.
- If flicker reduction does not produce the desired results, turn the camera off and aim it at the subject or light source before turning it on again.
- If **[ON]** is selected and flicker is detected when the shutter is released, a green ● will appear next to the **FLICKER** icon in the shooting display.
- If **[ON]** is selected, the shooting display will briefly go dark when the shutter is released. In continuous high-speed and continuous low-speed modes, the camera will behave as described below.
 - **Continuous high-speed:** Priority is given to frame rate. The display will briefly go dark with the first shot in each burst but not with the subsequent shots.
 - **Continuous low-speed:** Priority is given to flicker reduction. The display will briefly go dark each time the shutter is released and the frame rate may drop or become erratic.

✓ “[Photo Flicker Reduction]”

- Flicker reduction may slightly delay shutter response.
- Flicker reduction can detect flicker at 100 and 120 Hz (associated respectively with AC power supplies of 50 and 60 Hz). The desired results may not be achieved if the frequency of the power supply changes during burst photography.
- Flicker may not be detected or the desired results may not be achieved depending on the light source and shooting conditions, for example with scenes that are brightly lit or feature dark backgrounds.
- The desired results may also not be achieved with decorative lighting displays and other non-standard lighting.
- The actual effects of photo flicker reduction may differ from those visible in the display.

✓ Continuous High-Speed

- When **[Focus]** is selected for Custom Setting a1 **[AF-C priority selection]**, flicker reduction for continuous high-speed release mode behaves in the same way as it does for continuous low-speed release.
- Flicker reduction may not produce the desired results during burst photography if:
 - the shutter speed changes (mode **A** or **P**),
 - the frame advance rate slows, or
 - the bursts are long.

✓ [Photo Flicker Reduction]: Restrictions

[Photo flicker reduction] does not take effect under some conditions, including during:

- HDR overlay and
 - high-speed frame capture +.
-

High-Frequency Flicker Reduction

MENU button → 📷 photo shooting menu

Selecting [**On (shutter speed fine-tuning)**] allows shutter speeds between $\frac{1}{8000}$ and $\frac{1}{30}$ s to be adjusted in smaller increments in modes **S** and **M**, letting speeds that keep flicker to a minimum be found by viewing the preview in the shooting display.

- Flicker may cause banding in pictures taken under high-frequency LED lighting or in shots that include monitors with high-frequency LED displays. Reducing the size of the increments used for shutter-speed selection helps in identifying speeds that keep flicker to a minimum.

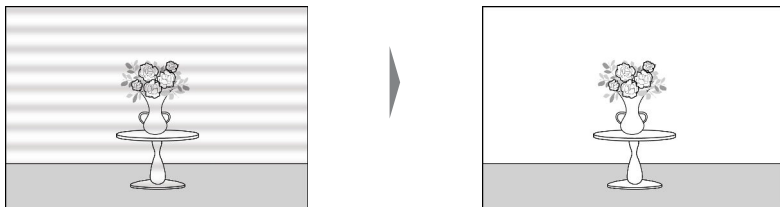

- After choosing a shutter speed suited to your subject, enable high-frequency flicker reduction and fine-tune shutter speed while viewing your subject in the shooting display until you find a value that minimizes flicker and banding. The effect can be more readily ascertained by zooming in on your subject using display zoom.
- When high-frequency flicker reduction is enabled, the shutter speed display shows only the denominator, with a digit added after the decimal point.
- The precise shutter speed is shown. For example, the shutter speed when $\frac{1}{500}$ s is selected is precisely $\frac{1}{512}$ s, which the display shows as "512.0", the denominator.



- Turning high-frequency flicker reduction off returns shutter speed to the nearest of the values normally displayed.

✓ **Cautions: High-Frequency Flicker Reduction**

- The effects of flicker in the shooting display may differ from those seen in photographs. We recommend that you take test shots to identify the shutter speed that minimizes flicker and banding.
 - Exposure maintenance is disabled while high-frequency flicker reduction is in effect, even when **[Shutter speed]** is selected for Custom Setting b7 **[Keep exp. when f/changes]**.
-

Tip: Using “Recall Shooting Functions” with High-Frequency Flicker Reduction

Selecting **[Save current settings]** for Custom Setting f2 **[Custom controls (shooting)]** > **[Recall shooting functions]** or **[Recall shooting functions (hold)]** while high-frequency flicker reduction is in effect saves the shutter speed currently selected via fine-tuning. This allows you to, for example, identify and save the shutter speed that minimizes striping in a high-frequency LED display and then instantly recall the stored value using the selected button only when the LED display is in the frame.

Metering

MENU button → photo shooting menu

Metering determines how the camera sets exposure.

Option	Description
☒ [Matrix metering]	The camera meters a wide area of the frame and sets exposure according to tone distribution, color, composition, and distance for results close to those seen by the naked eye.
☒ [Center-weighted metering]	<ul style="list-style-type: none">• The camera assigns the greatest weight to the center of the frame. This mode can, for example, be used with subjects that dominate the composition.• Center-weighted metering is also recommended when using filters with an exposure factor (filter factor) over 1×.• The size of the area assigned the greatest weight can be selected using Custom Setting b5 [Center-weighted area].• The metered area can be displayed or hidden using Custom Settings d18 [Custom monitor shooting display] and d19 [Custom viewfinder shooting display].
☒ [Spot metering]	<ul style="list-style-type: none">• The camera meters a circle with a diameter of 4 mm/ 0.16 in. (equivalent to approximately 1.5% of the frame). This ensures that the subject will be correctly exposed even when the background is much brighter or darker.• The metered area is centered on the current focus point. If [Auto-area AF] is selected for AF-area mode (📖 112), the camera will instead meter the center focus point.
☒* [Highlight-weighted metering]	The camera assigns the greatest weight to highlights. Use this option to reduce loss of detail in highlights, for example when photographing spotlight performers on stage.

Flash Control

MENU button → photo shooting menu

Adjust settings for wireless remote flash units or optional flash units mounted on the camera accessory shoe.

- For information on adjusting settings for optional flash units mounted on the camera accessory shoe, see “On-Camera’ Versus ‘Remote’” ([403](#)).
- For information on adjusting settings for wireless remote flash units, see “What Is Remote Flash Photography?” ([414](#)).

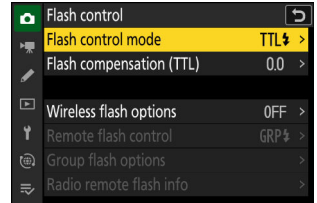

Flash Control Mode

Choose a flash control mode and flash level and adjust other settings for SB-5000, SB-500, SB-400, or SB-300 flash units mounted on the camera accessory shoe.

- The options available in the flash control display vary with the option selected for **[Flash control mode]**.
- Settings for flash units other than the SB-5000, SB-500, SB-400, and SB-300 can only be adjusted using flash unit controls.
- Settings for an SB-5000 mounted on the accessory shoe can also be adjusted using the controls on the flash unit.

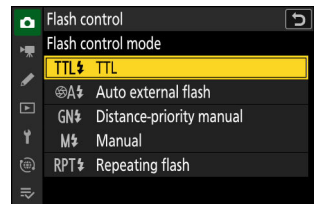



Option	Description
[TTL]	Flash output is adjusted automatically in response to shooting conditions.
[Auto external flash]	Light from the flash is reflected from the subject to an auto external flash sensor and flash output adjusted automatically.
[Distance-priority manual]	Choose the distance to the subject; flash output will be adjusted automatically.
[Manual]	Choose the flash level manually.
[Repeating flash]	The flash fires repeatedly during the exposure, producing a multiple-exposure effect.

Wireless Flash Options

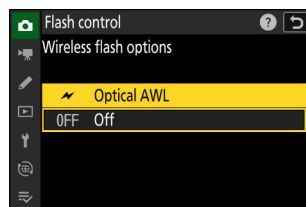
Adjust settings for simultaneous wireless control of multiple remote flash units. This option is available only when an SB-5000 or SB-500 flash unit or a WR-R11a or WR-R10 wireless remote controller is mounted on the camera.



Option	Description
 [Optical AWL]	The remote flash units are controlled using low-intensity flashes emitted by the master flash (426).
 [Radio AWL]	The remote flash units are controlled by radio signals from a WR-R11a/WR-R10 attached to the camera (415).
[Off]	Remote flash photography disabled.

Remote Flash Control

Choose the remote flash control mode. Flash options can be adjusted in the flash control display; the options available vary with the option selected for **[Remote flash control]**.

Option	Description
[Group flash]	Choose a separate flash control mode for each group of remote flash units (419 , 427).
[Quick wireless control]	Choose the balance between groups A and B and adjust output for group C manually (421 , 430).
[Remote repeating]	The flash units fire repeatedly while the shutter is open, producing a multiple-exposure effect (423 , 433).

Radio Remote Flash Info

View the flash units currently controlled via radio AWL.

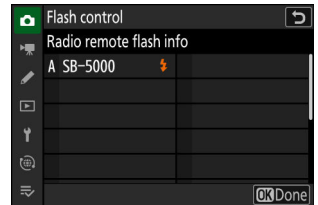

Focus Mode

MENU button ➡ 📷 photo shooting menu

Control how the camera focuses. For more information, see “Choosing a Focus Mode” ([📖 110](#)), part of the section on “Focus” in the “Shooting Settings” chapter.

AF-Area Mode

MENU button ➡  photo shooting menu

Choose how the camera selects the focus point for autofocus. For more information, see “Choosing an AF-Area Mode” ([📖 112](#)), part of the section on “Focus” in the “Shooting Settings” chapter.

AF Subject Detection Options



MENU button ➡  photo shooting menu

Choose the type of subject to which the camera gives priority when focusing using autofocus. For more information, see “Choosing a Subject Type for Autofocus” ([📖 116](#)), part of the section on “Focus” in the “Shooting Settings” chapter.

Vibration Reduction

MENU button → photo shooting menu

Choose whether to enable vibration reduction. The options available vary with the lens.

Option		Description
 [Normal]	Choose for enhanced vibration reduction when photographing static subjects.	
 [Sport]	Choose when photographing athletes and other subjects that are moving rapidly and unpredictably.	
[Off]	Vibration reduction is disabled.	

Cautions: Using Vibration Reduction

- Vibration reduction may be unavailable with some lenses.
- We recommend that you wait for the image in the display to stabilize before shooting.
- When [Normal] is selected for lenses that support vibration reduction, the image in the viewfinder may jiggle before the shutter is released, but this is a natural consequence of how vibration reduction is performed and does not indicate a malfunction. [Sport] or [Off] can be used should you find the motion distracting.
- [Normal] or [Sport] is recommended for panning shots. In [Normal] and [Sport] modes, vibration reduction applies only to motion that is not part of the pan. If the camera is panned horizontally, for example, vibration reduction will be applied only to vertical shake.
- [Normal] and [Sport] are also recommended if the camera is mounted on a tripod or monopod. Note, however, that [Off] may be a better choice with some tripods depending on shooting conditions. Settings may vary from lens to lens; consult the lens documentation for more information.
- If an F mount lens with a vibration reduction switch is attached via an optional FTZ II/FTZ mount adapter, [Vibration reduction] will be grayed out and unavailable. Use the lens switch for vibration reduction.

Auto Bracketing



MENU button ➡  photo shooting menu

Bracketing automatically varies exposure, flash level, Active D-Lighting (ADL), or white balance slightly with each shot, “bracketing” the current value. For more information, see “Auto Bracketing” ([📖 170](#)) in the “Shooting Settings” chapter.

Multiple Exposure

MENU button → 📷 photo shooting menu

Record two to ten NEF (RAW) exposures as a single photograph.

Option	Description
[Multiple exposure mode]	<ul style="list-style-type: none"> • [On (series)]: Take a series of multiple exposures. To end multiple exposure photography, select [Multiple exposure mode] again and choose [Off]. • [On (single photo)]: End multiple exposure photography after creating a single multiple exposure. • [Off]: End multiple exposure photography.
[Number of shots]	<p>Choose the number of exposures that will be combined to form a single photograph.</p>
[Overlay mode]	<ul style="list-style-type: none"> • [Add]: The exposures are overlaid without modification; gain is not adjusted. • [Average]: Gain is adjusted before the exposures are overlaid. The gain for each exposure is equal to 1 divided by the total number of exposures taken. For example, in a photo made by combining two exposures, the gain for each exposure will be set to $\frac{1}{2}$, while in a photo combining three exposures, gain will be set to $\frac{1}{3}$. • [Lighten]: The camera compares the pixels in each picture and uses only the brightest. <div style="text-align: center;">  </div> <ul style="list-style-type: none"> • [Darken]: The camera compares the pixels in each picture and uses only the darkest. <div style="text-align: center;">  </div>

Option	Description
[Save individual pictures (RAW)]	<ul style="list-style-type: none">• [ON]: Save both the multiple exposure and the shots that make it up; the pictures are saved in NEF (RAW) format.• [OFF]: Discard the individual shots and save only the multiple exposure.
[Overlay shooting]	If [ON] is selected, earlier exposures will be superimposed on the view through the lens. The earlier exposures aid composition of the next shot.
[Select first exposure (RAW)]	Choose the first exposure from the NEF (RAW) pictures on the memory card.

5 Choose a setting for [Save individual pictures (RAW)].

To save both the multiple exposure and the shots that make it up, select **[ON]**; the individual shots are saved in NEF (RAW) format. To save only the multiple exposure, select **[OFF]**.

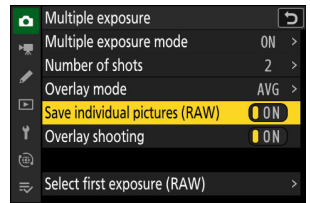

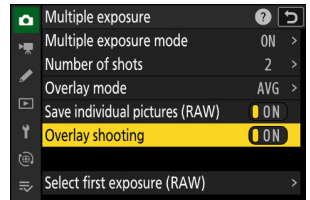

6 Choose an option for [Overlay shooting].

Select **[ON]** to superimpose earlier exposures on the view through the lens. You can use the earlier exposures as a guide when composing subsequent shots.



7 Choose an option for [Select first exposure (RAW)].

- To choose the first exposure from existing NEF (RAW) photos, highlight [Select first exposure (RAW)] and press .
- Highlight the desired picture using the multi selector.
- To view the highlighted picture full screen, press and hold the  button.
- After highlighting the desired picture, press .

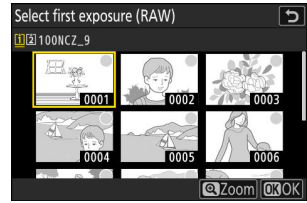

8 Start shooting.

- Take the selected number of shots. If you used [Select first exposure (RAW)] to select an existing NEF (RAW) picture as the first exposure in Step 7, shooting will start from the second exposure.
- Once you have taken the selected number of shots, the pictures will be overlaid to create a multiple exposure. Multiple exposures are recorded in JPEG format regardless of the option selected for image quality.
- If [On (series)] is selected for [Multiple exposure mode], you can continue to take additional multiple exposures until [Off] is selected.
- If [On (single photo)] is selected, the camera will exit multiple exposure mode once the number of shots selected in Step 3 has been taken.

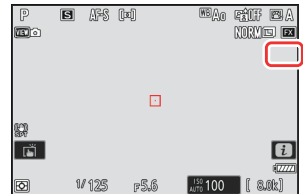
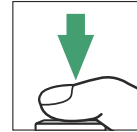

The **i** Menu

Pictures can be viewed by pressing the **▶** button while a multiple exposure is in progress. The most recent shot in the current multiple exposure is indicated by a **▶** icon; pressing the **i** button when this icon is present displays the multiple exposure **i** menu.

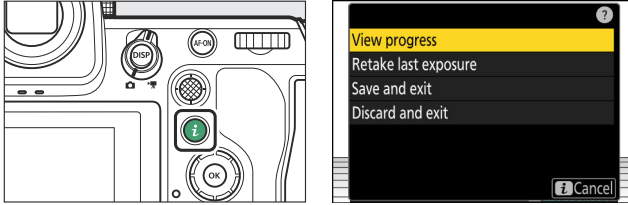

- Highlight items and press **OK** to select.
- You also have the option of using touch controls after pressing the **i** button.

Option	Description
[View progress]	View a preview created from the exposures recorded to the current point.
[Retake last exposure]	Retake the most recent exposure.
[Save and exit]	Create a multiple exposure from the exposures taken to current point.
[Discard and exit]	Exit without recording a multiple exposure. <ul style="list-style-type: none">• If [ON] is selected for [Save individual pictures (RAW)], the individual exposures will be saved separately.

✔ **Cautions: Multiple Exposure**

- If you use the menus or view pictures in the display while shooting a multiple exposure, remember that shooting will end and the multiple exposure will be recorded if no operations are performed for about 40 seconds (or in the case of menus, about 90 seconds). The time available to record the next exposure can be extended by choosing longer times for Custom Setting c3 [**Power off delay**] > [**Playback**] or [**Menus**].
- Multiple exposures may be affected by “noise” in the form of randomly-spaced bright pixels, fog, or lines.
- In continuous shooting modes, the camera records all exposures in a single burst. If [**On (single photo)**] is selected, multiple exposure shooting will end after the first multiple exposure is recorded. If [**On (series)**] is selected, an additional multiple exposure will be recorded each time the shutter-release button is pressed.
- In self-timer mode, the interval between each shot in the exposure is selected using Custom Setting c2 [**Self-timer**] > [**Interval between shots**]. Regardless of the value selected for the c2 [**Number of shots**] option, shooting will however end after the number of shots selected for the multiple exposure.
- Multiple exposures may end if settings are changed while shooting is in progress.
- Shooting settings and photo info for multiple exposure photographs are those for the first exposure.
- Do not remove or replace the memory card while a multiple exposure is in progress.
- Memory cards cannot be formatted while a multiple exposure is in progress. Some menu items will be grayed out and unavailable.

✔ **Multiple Exposure: Restrictions**

Multiple exposure cannot be combined with some camera features, including:

- video recording,
 - high-speed frame capture +,
 - bracketing,
 - HDR overlay,
 - interval-timer photography,
 - time-lapse video recording, and
 - focus shift.
-

Ending Multiple Exposures

To end a multiple exposure before the specified number of exposures have been taken, select **[Off]** for multiple exposure mode. A multiple exposure will be created from the exposures that have been recorded to that point (if **[Average]** is selected for **[Overlay mode]**, gain will be adjusted to reflect the number of exposures actually recorded).

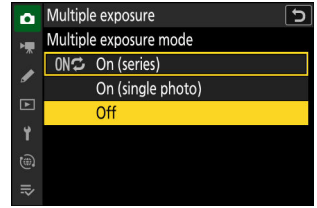

The multiple exposure will also end if:

- the standby timer expires after the first exposure has been taken, or
- you press the **[▶]** button followed by the **[i]** button and select either **[Save and exit]** or **[Discard and exit]**

HDR Overlay

MENU button → 📷 photo shooting menu

Used with high contrast subjects, High Dynamic Range (HDR) preserves details in highlights and shadows by combining two shots taken at different exposures. Use with high-contrast scenes and other subjects to preserve a wide range of details, from highlights to shadows.



Option	Description
[HDR mode]	<ul style="list-style-type: none">• [On (series)]: Take a series of HDR photographs. To end HDR photography, select [HDR mode] again and choose [Off].• [On (single photo)]: End HDR photography after recording a single HDR photograph.• [Off]: End HDR photography.
[HDR strength]	Adjust HDR strength. If [Auto] is selected, the camera will automatically adjust HDR strength to suit the scene.
[Save individual pictures (RAW)]	Choose [ON] to save each of the individual shots used to create the HDR picture; the shots are saved in NEF (RAW) format.

Taking HDR Photographs

We recommend that you use the matrix metering option when shooting with HDR.

- 1 Highlight [HDR overlay] in the photo shooting menu and press .

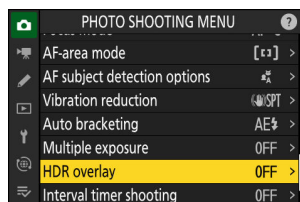

2 Select an [HDR mode].

- Highlight **[HDR mode]** and press \odot .



- Highlight one of the following options using \uparrow or \downarrow and press \odot .

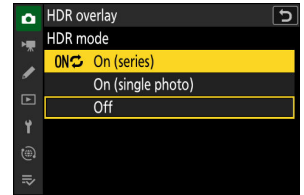

Option		Description
$\text{ON} \rightleftarrows$	[On (series)]	Take a series of HDR photographs. HDR shooting will continue until you select [Off] for [HDR mode] .
	[On (single photo)]	Normal shooting will resume after you have taken a single HDR photograph.
	[Off]	Proceed without taking additional HDR photographs.

- If **[On (series)]** or **[On (single photo)]** is selected, an icon will appear in the display.



3 Choose an [HDR strength].

- Highlight [HDR strength] and press \odot .

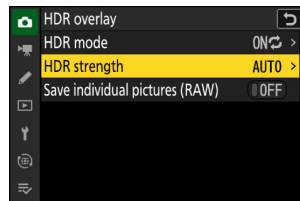

- Highlight an option using \odot or \odot and press \odot .
- If [Auto] is selected, the camera will automatically adjust HDR strength to suit the scene.

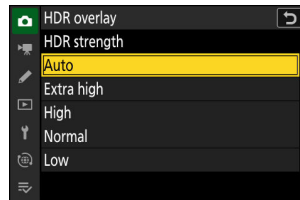

4 Choose a setting for [Save individual pictures (RAW)].

Choose [ON] to save each of the individual shots used to create the HDR picture; the shots are saved in NEF (RAW) format.

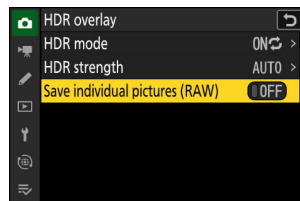

5 Frame the photograph, focus, and shoot.

- The camera takes two exposures when the shutter-release button is pressed all the way down.
- “**Busy**” will flash in the control panel while the pictures are combined. No photographs can be taken until recording is complete.
- If [On (series)] is selected for [HDR mode], you can continue to take HDR photographs until [Off] is selected.
- If [On (single photo)] is selected, HDR will turn off automatically after a single shot.
- HDR photographs are recorded in JPEG format regardless of the option selected for image quality.

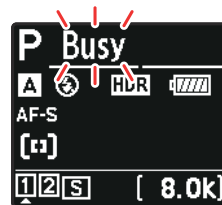

✓ Cautions: HDR Photography

- The edges of the picture will be cropped out.
- The desired results may not be achieved if the camera or subject moves during shooting. Use of a tripod is recommended.
- Depending on the scene, you may notice shadows around bright objects or halos around dark objects. In other cases, the effect produced by HDR may not be particularly noticeable.
- Uneven shading may be visible with some subjects.
- When spot or center-weighted metering is selected, an **[HDR strength]** setting of **[Auto]** is equivalent to **[Normal]**.
- Optional flash units will not fire.
- In continuous release modes, only one photograph will be taken each time the shutter-release button is pressed all the way down.
- Shutter speeds of **"Bulb"** and **"Time"** are not available.

✓ HDR: Restrictions

HDR cannot be combined with some camera features, including:



- photo flicker reduction,
 - high-speed frame capture +,
 - bracketing,
 - multiple exposures,
 - interval-timer photography,
 - time-lapse video recording, and
 - focus shift.
-

Interval Timer Shooting

MENU button →  photo shooting menu

Take photographs at the selected interval until the specified number of shots has been recorded. When using the interval timer, select a release mode other than self-timer or high-speed frame capture +.

Option	Description
[Start]	Start interval timer shooting. Shooting will begin either after about 3 s ([Now] selected for [Choose start day/time]) or at a selected date and time ([Choose day/time]). Shooting will continue at the selected interval until all shots have been taken.
[Choose start day/time]	Choose a start option. Select [Now] to start shooting immediately, [Choose day/time] to start shooting at a chosen date and time.
[Interval]	Specify the interval between shots in hours, minutes, and seconds.
[Intervals×shots/interval]	Choose the number of intervals and the number of shots per interval.
[Exposure smoothing]	Selecting [ON] allows the camera to adjust exposure to match the previous shot. <ul style="list-style-type: none">• Large changes in subject brightness during shooting may result in apparent variations in exposure. This can be addressed by shortening the interval between shots.• Exposure smoothing will not take effect in mode M if [OFF] is selected for [ISO sensitivity settings] > [Auto ISO sensitivity control] in the photo shooting menu.

Option	Description
[Interval priority]	<ul style="list-style-type: none"> • [ON]: Enable interval priority to ensure that frames shot in modes P and A are taken at the chosen interval. <ul style="list-style-type: none"> - Flash photography is disabled. - Release priority is enabled regardless of the options selected for Custom Settings a1 [AF-C priority selection] and a2 [AF-S priority selection]. - If [ON] is selected for [ISO sensitivity settings] > [Auto ISO sensitivity control] and the time chosen for [Minimum shutter speed] is longer than the interval, the time selected for the interval will take priority over the selected shutter speed. • [OFF]: Disable interval priority to ensure that photos are correctly exposed.
[Focus before each shot]	<p>If [ON] is selected, the camera will focus between shots. Select [OFF] to focus at a fixed distance.</p>
[Options]	<p>Combine interval-timer photography with other options.</p> <ul style="list-style-type: none"> • [AE bracketing]: Perform exposure bracketing during interval-timer photography. • [Time-lapse video]: Use the photos taken during interval-timer photography to create a time-lapse video with an aspect ratio of 16:9. <ul style="list-style-type: none"> - The camera saves both the photos and the time-lapse video. - Selecting [1:1 (24×24)] for [Image area] > [Choose image area] in the photo shooting menu disables the shutter release. - Videos created using [Time-lapse video] are recorded in the [sRGB] color space, regardless of the option selected for [Color space] in the photo shooting menu. • [Off]: Do not perform additional operations during interval-timer photography.
[Starting storage folder]	<p>Highlight options and press  or  to select (<input checked="" type="checkbox"/>) or deselect (<input type="checkbox"/>)</p> <ul style="list-style-type: none"> • [New folder]: A new folder is created for each new sequence. • [Reset file numbering]: File numbering is reset to 0001 whenever a new folder is created.

Interval-Timer Photography

✓ Before Shooting

- Take a test shot at current settings.
- Before proceeding, select [**Time zone and date**] in the setup menu and make sure that the camera clock is set to the correct time and date.
- To ensure that shooting is not interrupted, use a fully-charged battery, the supplied charging AC adapter, or an optional AC adapter and power connector.

1 Highlight [Interval timer shooting] in the photo shooting menu and press .

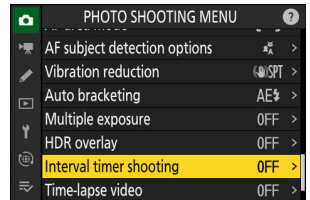

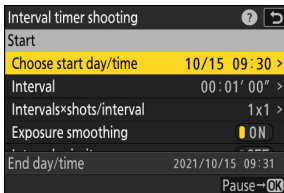

2 Adjust interval timer settings.

- Choose the start day and time.

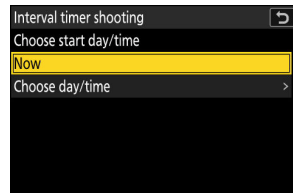

Highlight [**Choose start day/time**] and press .



Highlight an option and press .

- To start shooting immediately, select [**Now**].
- To start shooting at a chosen date and time, select [**Choose day/time**]. Choose the date and time and press .

- Choose the interval between shots.

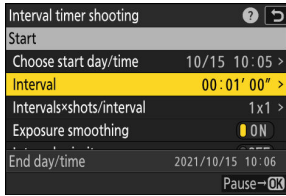

Highlight [**Interval**] and press

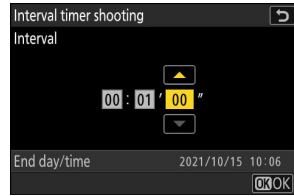

Choose an interval (in hours, minutes, and seconds) and press .

- Choose the number of shots per interval.

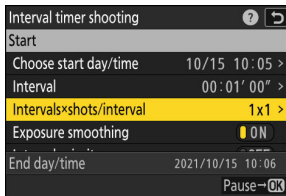

Highlight [**Intervals×shots/interval**] and press .



Choose the number of intervals and the number of shots per interval and press .

- In single frame release mode, the photographs for each interval will be taken at the rate for continuous high-speed release mode.

- **Enable or disable exposure smoothing.**

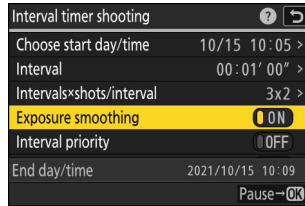

Highlight [**Exposure smoothing**] and press \odot to select [**ON**] or [**OFF**].

- Selecting [**ON**] allows the camera to adjust exposure to match the previous shot.

- **Choose an interval priority option.**

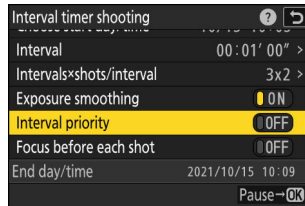

Highlight [**Interval priority**] and press \odot to select [**ON**] or [**OFF**].

- **Choose whether the camera focuses between shots.**

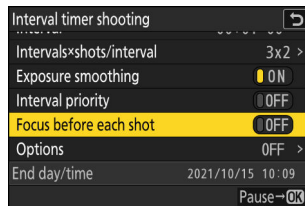

Highlight [**Focus before each shot**] and press \odot to select [**ON**] or [**OFF**].

- If [**ON**] is selected for [**Focus before each shot**], the camera will focus before each shot according to the option currently selected for focus mode.

- Choose additional options.

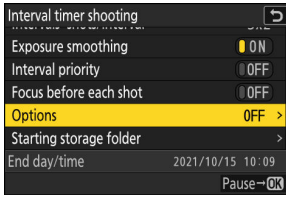

Highlight [**Options**] and press .



Highlight [**AE bracketing**] or [**Time-lapse video**] and press .

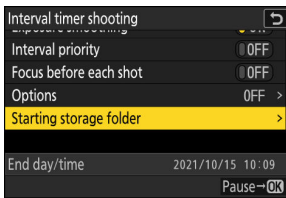

- If you selected [**AE bracketing**], choose values for [**Number of shots**] and [**Increment**]; if you selected [**Time-lapse video**], choose settings for [**Video file type**], [**Frame size/frame rate**], and [**Destination**].

- Choose starting folder options.

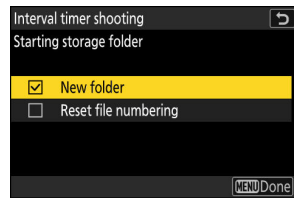

Highlight [**Starting storage folder**] and press .





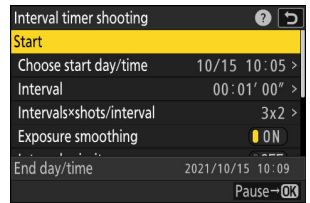

After highlighting the desired options and pressing  to turn them on () or off (), press .

3 Highlight [Start] and press \odot .

- If [**Now**] was selected for [**Choose start day/time**] in Step 2, shooting will start after about 3 s.
- Otherwise shooting will start at the time selected for [**Choose start day/time**] > [**Choose day/time**].
- The display turns off during shooting.
- Shooting will continue at the selected interval until all shots have been taken.



✓ During Shooting

- A  icon is displayed in the control panel during interval timer photography. If [**Time-lapse video**] is selected for [**Options**], a  icon will also be displayed.
- If the display is turned on by pressing the shutter-release button halfway, the message [**Interval timer shooting**] will be displayed and the  icon will flash. If [**Time-lapse video**] is selected for [**Options**], a  icon will also be displayed.

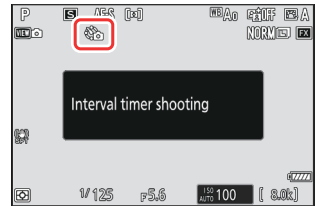
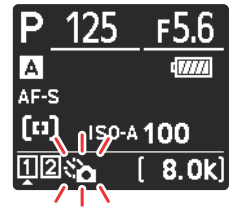

Pausing Interval-Timer Photography

Interval-timer photography can be paused between intervals by pressing \odot or by selecting [**Interval timer shooting**] in the photo shooting menu, highlighting [**Pause**], and pressing \odot . Note that the menus may not be displayed when the MENU button is pressed if the time selected for [**Interval**] is very short.

- If [**Time-lapse video**] is selected for [**Options**], pressing \odot between intervals will end interval-timer photography.

Resuming Interval-Timer Photography

Interval timer shooting can be resumed as described below.

- To resume shooting immediately:

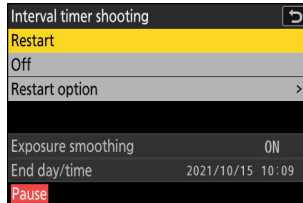

Highlight [**Restart**] and press \odot .

- To resume shooting at a specified time:

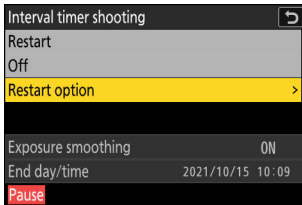

Highlight [**Restart option**] and press \odot , then highlight [**Choose day/time**] and press \odot .

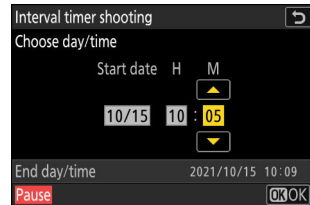

Choose a starting date and time and press \odot .

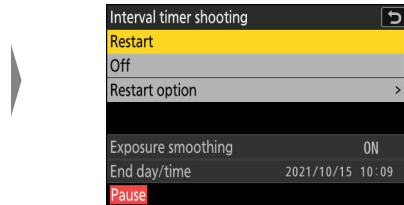

Highlight [**Restart**] and press \odot .

Ending Interval-Timer Photography

To end interval-timer photography before all the photos are taken, select **[Interval timer shooting]** in the photo shooting menu, highlight **[Off]**, and press **Ⓜ**. Note that the menus may not be displayed when the **MENU** button is pressed if the time selected for **[Interval]** is very short. In this case you will need to press **Ⓜ** to pause interval-timer photography and then select **[Interval timer shooting]** in the photo shooting menu, highlight **[Off]**, and press **Ⓜ**.

✔ Cautions: Interval-Timer Photography

- Choose an interval longer than the time needed to take the selected number of shots at the predicted shutter speed. Note that during actual interval-timer photography, the camera must not only take shots at the selected interval but must also have sufficient time to complete the exposures and perform such tasks as processing the photographs. If the interval is too short to take the selected number of photos, the camera may skip to the next interval without shooting.
- If the interval is too short, the total number of shots taken may be less than that selected for **[Intervals×shots/interval]**.
- If you are using a flash, choose an interval longer than the time needed for the flash to charge. If the interval is too short, the flash may fire at less than the power needed for full exposure.
- If shooting cannot proceed at current settings—for example, if shutter speed is set to “**Bulb**” or “**Time**”, the **[Interval]** is **[00:00'00”]**, or the start time is in less than a minute—a warning will be displayed.
- If **[Time-lapse video]** is selected for **[Options]**, the standby timer will not expire during interval-timer photography, regardless of the option selected for Custom Setting c3 **[Power off delay]** > **[Standby timer]**.
- If **[Time-lapse video]** is selected for **[Options]** at a frame size 7680 × 4320, interval-timer photography will not start if:
 - **[DX (24×16)]** or **[1:1 (24×24)]** is selected for **[Image area]** > **[Choose image area]** in the photo shooting menu, or
 - a DX lens is attached.
- If the memory card is full, the interval timer will remain active but no pictures will be taken. Insert another memory card and resume shooting ([📖 498](#)).
- Depending on memory card performance and shooting conditions, shooting may end before the selected number of shots have been taken or the selected number of intervals is complete.
- Interval timer shooting will pause if:
 - the camera is turned off and then on again (when the camera is off, batteries and memory cards can be replaced without ending interval-timer photography), or
 - self-timer or high-speed frame capture + is selected for release mode.
- Changing camera settings while the interval timer is active may cause shooting to end.

✔ Release Mode

Regardless of the release mode selected, the camera will take the specified number of shots at each interval.

✔ Adjusting Settings Between Shots

Pictures can be viewed and shooting and menu settings adjusted between shots. Note, however, that the display will turn off and shooting will resume a few seconds before the next shot is taken.

✔ **Interval-Timer Photography: Restrictions**

Interval-timer photography cannot be combined with some camera features, including:

- video recording,
- long time-exposures (“Bulb” or “Time”),
- the self-timer,
- high-speed frame capture +,
- bracketing,
- multiple exposures,
- HDR overlay, and
- focus shift.

✔ **Interval Timer Settings**

Turning the camera off or selecting a new release mode does not affect interval-timer photography settings.

✔ **Shooting Menu Banks**

You cannot change or reset shooting menu banks while interval-timer photography is in progress.

Time-Lapse Video

MENU button ➡ 📷 photo shooting menu

The camera automatically takes photos at selected intervals to create a time-lapse video.

Option	Description
[Start]	Start time-lapse recording. Shooting starts after about 3 s and continues at the interval selected for [Interval] for the time selected for [Shooting time].
[Interval]	Choose the interval between shots, in minutes and seconds.
[Shooting time]	Choose how long the camera will continue to take pictures, in hours and minutes.
[Exposure smoothing]	Selecting [ON] smooths abrupt changes in exposure. <ul style="list-style-type: none">• Large changes in subject brightness during shooting may result in apparent variations in exposure. This can be addressed by shortening the interval between shots.• Exposure smoothing will not take effect in mode M if [OFF] is selected for [ISO sensitivity settings] > [Auto ISO sensitivity control] in the photo shooting menu.
[Choose image area]	Choose the image area for time-lapse videos from [FX] and [DX].
[Video file type]	Choose the video file type for the final video.
[Frame size/frame rate]	Choose the frame size and rate for the final video. The options available vary with the setting chosen for [Video file type].

Option	Description
[Interval priority]	<ul style="list-style-type: none"> • [ON]: Enable interval priority to ensure that frames shot in modes P and A are taken at the chosen interval. <ul style="list-style-type: none"> - Release priority is enabled regardless of the options selected for Custom Settings a1 [AF-C priority selection] and a2 [AF-S priority selection]. - If [ON] is selected for [ISO sensitivity settings] > [Auto ISO sensitivity control] and the time chosen for [Minimum shutter speed] is longer than the interval, the time selected for the interval will take priority over the selected shutter speed. • [OFF]: Disable interval priority to ensure that photos are correctly exposed.
[Focus before each shot]	If [ON] is selected, the camera will focus between shots.
[Destination]	Choose the slot used to record time-lapse videos when two memory cards are inserted.

Recording Time-Lapse Videos

✓ Before Shooting

- Time-lapse videos are shot using the video crop.
- Take test shots and check the results in the monitor.
- Before proceeding, select [Time zone and date] in the setup menu and make sure that the camera clock is set to the correct time and date.
- To ensure that shooting is not interrupted, use a fully-charged battery, the supplied charging AC adapter, or an optional AC adapter and power connector.

1 Highlight [Time-lapse video] in the photo shooting menu and press .

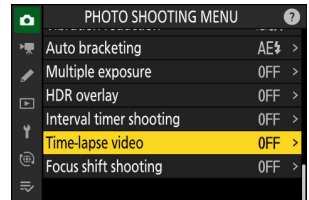

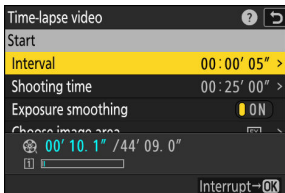

2 Adjust time-lapse video settings.

- Choose the interval between shots.

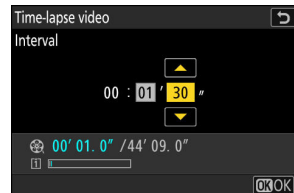

Highlight [Interval] and press .



Choose an interval (in minutes and seconds) and press .

- Choose an interval longer than the slowest anticipated shutter speed.

- **Choose the total shooting time.**

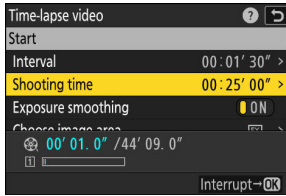

Highlight [**Shooting time**] and press .

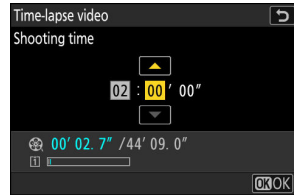

Choose a shooting time (in hours and minutes) and press .

- The maximum shooting time is 23 hours and 59 minutes.

- **Enable or disable exposure smoothing.**

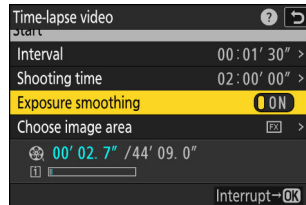

Highlight [**Exposure smoothing**] and press  to select [**ON**] or [**OFF**].

- Selecting [**ON**] smooths abrupt changes in exposure.

- **Choose the image area.**

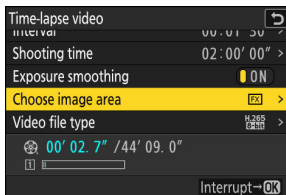

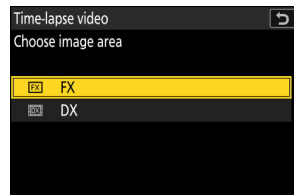

Highlight [**Choose image area**] and press .



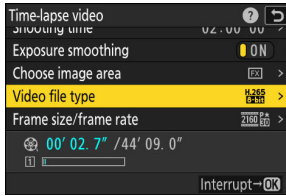

Highlight an option and press .

- Choose a video file type.



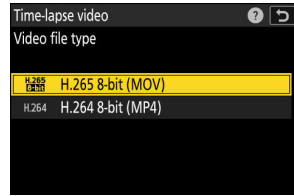

Highlight **[Video file type]** and press .



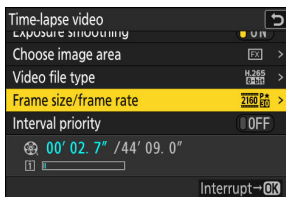

Highlight an option and press .

- Choose the frame size and rate.



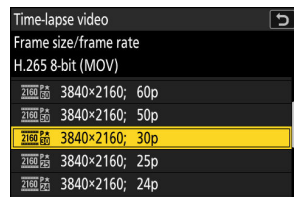

Highlight **[Frame size/frame rate]** and press .

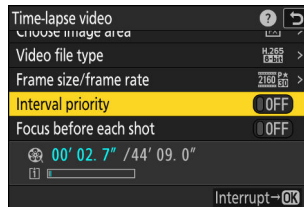

Highlight an option and press .

- Choose an interval priority option.



Highlight **[Interval priority]** and press  to select **[ON]** or **[OFF]**.

- Choose whether the camera focuses between shots.

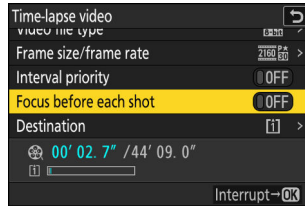

Highlight [**Focus before each shot**] and press \odot to select [**ON**] or [**OFF**].

- If [**ON**] is selected for [**Focus before each shot**], the camera will focus before each shot according to the option currently selected for focus mode.

- Choose a destination.

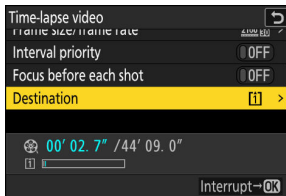

Highlight [**Destination**] and press \odot .

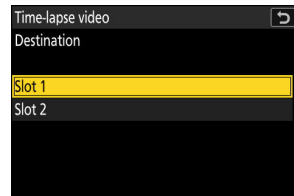

Highlight the slot that will be used to record time-lapse videos when two memory cards are inserted and press

\odot .

3 Highlight [**Start**] and press \odot .

- Shooting starts after about 3 s.
- The display turns off during shooting.
- The camera takes pictures at interval selected for [**Interval**] for the time selected for [**Shooting time**] in Step 2.

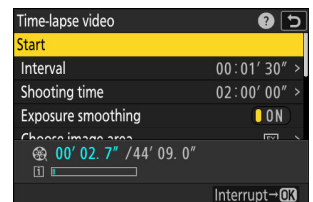

✓ During Shooting

- A  icon is displayed in the control panel during shooting.

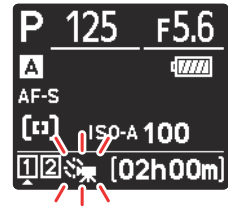

- If the display is turned on by pressing the shutter-release button halfway, the message **[Interval timer shooting]** will be displayed and the  icon will flash.

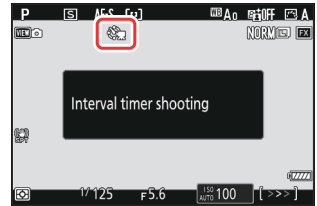

Ending Shooting

To end shooting before all the photos are taken, press **Ⓜ** or select **[Time-lapse video]** in the photo shooting menu, highlight **[Off]**, and press **Ⓜ**. Note that the menus may not be displayed when the **MENU** button is pressed if the time selected for **[Interval]** is very short.

- A video will be created from the frames shot to the point where shooting ended and normal photography will resume.

✓ Calculating the Length of the Final Video

- The total number of frames in the final video can be calculated by dividing the shooting time selected in Step 2 by the interval, rounding up, and adding 1.
- The length of the final video can then be calculated by dividing the number of shots by the frame rate selected for **[Frame size/frame rate]** (for example, a 48-frame video recorded with **[1920×1080; 24p]** selected for **[Frame size/frame rate]** will be about two seconds long).

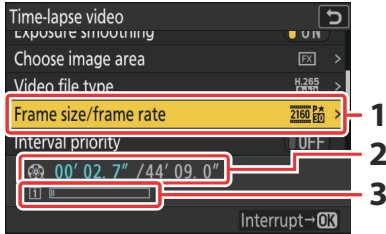



- 1 Frame size/frame rate
- 2 Length recorded/maximum length
- 3 Memory card indicator

✓ Picture Review

The  button cannot be used to view pictures while shooting is in progress. The current frame will however be displayed for a few seconds after each shot if **[On]** or **[On (monitor only)]** is selected for **[Picture review]** in the playback menu. Note that other playback operations cannot be performed while the frame is displayed. The current frame may not be displayed if the interval is very short.

✔ Cautions: Time-Lapse Videos

- Sound is not recorded with time-lapse videos.
- The shutter speed and the time needed to record the picture to the memory card may vary from shot to shot. As a result, camera may be unable to take shots at the selected interval.
- Shooting will not begin if a time-lapse video cannot be recorded at current settings, for example if:
 - the value selected for **[Interval]** is longer than that selected for **[Shooting time]**,
 - **[00:00'00"]** is selected for **[Interval]** or **[Shooting time]**, or
 - the memory card is full.
- Time-lapse recording will not start if the recording time is shown in red in the **[Time-lapse video]** display. Adjust the **[Interval]** or **[Shooting time]**.
- When 7680 × 4320 is selected for **[Frame size/frame rate]**, shooting will not start if a DX lens is attached or **[DX]** selected for **[Choose image area]**.
- The  button cannot be used to view pictures while time-lapse recording is in progress.
- For consistent coloration, choose a white balance setting other than  **[Auto]** or  **[Natural light auto]** when recording time-lapse videos.
- Regardless of the option selected for Custom Setting c3 **[Power off delay]** > **[Standby timer]**, the standby timer will not expire while recording is in progress.
- Shooting may end if camera controls are used, settings are changed, or an HDMI cable is connected. A video will be created from the frames shot to the point where shooting ended.
- The following end shooting without a beep sounding or a video being recorded:
 - Disconnecting the power source
 - Ejecting the memory card

✔ Adjusting Settings Between Shots

Shooting and menu settings can be adjusted between shots. Note, however, that the monitor will turn off approximately 2 s before the next shot is taken.

Time-Lapse Videos: Restrictions



Time-lapse video recording cannot be combined with some camera features, including:

- video recording,
 - long time-exposures (“Bulb” or “Time”),
 - the self-timer,
 - high-speed frame capture +,
 - bracketing,
 - multiple exposures,
 - HDR overlay,
 - interval-timer photography, and
 - focus shift.
-

Focus Shift Shooting

MENU button →  photo shooting menu

Focus shift automatically varies focus over a series of shots. Use it to take photos that will later be combined using focus stacking to create a single picture with increased depth of field. Before using focus shift, choose a focus mode of **AF-S** or **AF-C** and a release mode other than self-timer or high-speed frame capture +.

Option	Description
[Start]	Start shooting. The camera will take the selected number of shots, changing the focus distance by the selected amount with each shot.
[No. of shots]	Choose the number of shots (maximum 300).
[Focus step width]	Focus shift varies the focus distance over a series of photographs. Choose the amount the focus distance changes with each shot.
[Interval until next shot]	Choose the interval between shots, in seconds. <ul style="list-style-type: none">• Select [00] to take photos at up to about 5 fps.• To ensure correct exposure when using a flash, choose an interval long enough for the flash to charge.
[First-frame exposure lock]	<ul style="list-style-type: none">• [ON]: The camera locks exposure for all shots at the setting for the first frame.• [OFF]: The camera adjusts exposure before each shot.
[Focus position auto reset]	<ul style="list-style-type: none">• [ON]: Focus will return to the starting position once all the shots in the current sequence have been taken. This saves you having to refocus each time when photographing subjects at the same focus distance several times in succession.• [OFF]: Focus remains fixed at the position for the final shot in the sequence. This allows you to start from the most recent focus position when photographing a single subject over multiple consecutive series.
[Starting storage folder]	Highlight options and press  or  to select (<input checked="" type="checkbox"/>) or deselect (<input type="checkbox"/>). <ul style="list-style-type: none">• [New folder]: A new folder is created for each new sequence.• [Reset file numbering]: File numbering is reset to 0001 whenever a new folder is created.

Focus Shift Photography

✓ Before Shooting

- Take a test shot at current settings.
 - To ensure that shooting is not interrupted, use a fully-charged battery, the supplied charging AC adapter, or an optional AC adapter and power connector.
-

1 Focus.

- During focus shift, the camera takes a series of shots starting from a selected focus position and continuing toward infinity. Given that shooting ends when infinity is reached, the starting focus position should be slightly in front of (i.e., closer to the camera than) the closest point on the subject.
- Do not move the camera after focusing.

2 Highlight [Focus shift shooting] in the photo shooting menu and press .

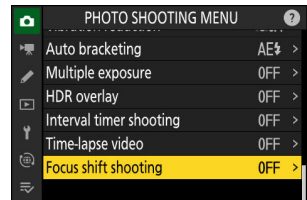

3 Adjust focus shift settings.

• **Choose the number of shots.**

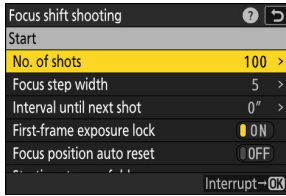

Highlight [**No. of shots**] and press .



Choose the number of shots and press .

- The maximum number of shots is 300.
- We recommend taking more shots than you think you'll need. You can winnow them down during focus stacking.
- More than 100 shots may be required for photographs of insects or other small objects. On the other hand, only a few may be needed to photograph a landscape from front to back with a wide-angle lens.

• **Choose the amount the focus distance changes with each shot.**

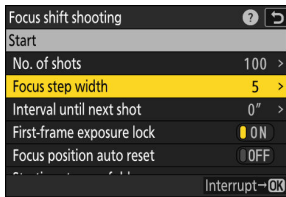

Highlight [**Focus step width**] and press .

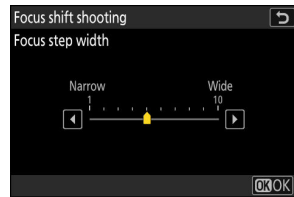

Choose a focus step width and press .

- Press to reduce the focus step width, to increase.
- Note that high settings increase the risk that some areas will be out of focus when the shots are stacked. A value of 5 or less is recommended.
- Try experimenting with different settings before shooting.

- **Choose the interval until next shot.**

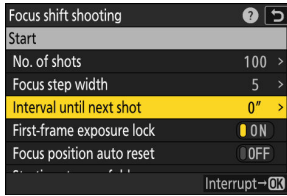

Highlight [**Interval until next shot**] and press **⏏**.

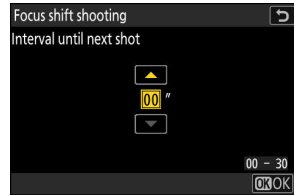

Choose the interval between shots and press **⏏**.

- Choose the interval between shots, in seconds.
- Select **[00]** to take photos at up to about 5 fps.
- To ensure correct exposure when using a flash, choose an interval long enough for the flash to charge. A setting of **[00]** is recommended when shooting without a flash.

- **Enable or disable first-frame exposure lock.**

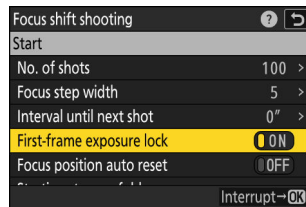

Highlight [**First-frame exposure lock**] and press **⏏** to select **[ON]** or **[OFF]**.

- **[OFF]** is recommended if lighting and other conditions will not change during shooting, **[ON]** when photographing landscapes and the like under variable lighting.
- Selecting **[ON]** locks exposure at the value for the first shot, ensuring that all photos have the same exposure. Large changes in subject brightness during shooting may however result in apparent variations in exposure. This can be addressed by selecting **[OFF]**.

- Choose whether the focus position returns to the starting position at the end of each sequence.

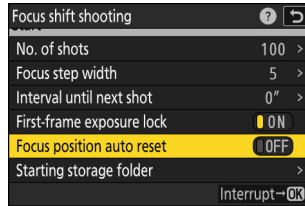

Highlight [**Focus position auto reset**] and press \odot to select [**ON**] or [**OFF**]

- We recommend selecting [**ON**] when using focus shift to photograph subjects at the same focus distance multiple times in succession.
- If [**OFF**] is selected, focus will remain fixed at the position for the final shot in the sequence.

- Choose starting folder options.

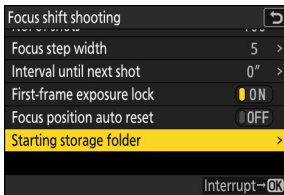

Highlight [**Starting storage folder**] and press \odot .

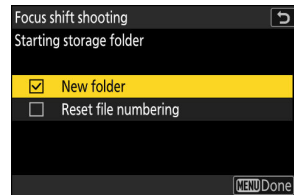

After highlighting the desired options and pressing \odot to turn them on () or off (), press \odot .

4 Highlight [Start] and press .

- Shooting starts after about 3 s.
- The display turns off during shooting.
- The camera takes photographs at the selected interval, starting at the focus distance selected at the start of shooting and progressing out toward infinity by the selected focus step distance with each shot.
- Shooting ends when the selected number of shots has been taken or focus reaches infinity.

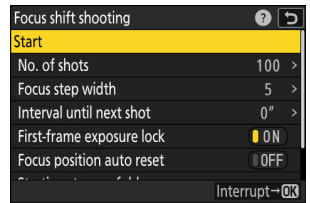

Ending Focus Shift Photography

To end shooting before all shots have been taken, either:

- select [**Focus shift shooting**] in the photo shooting menu, highlight [**Off**], and press **Ⓜ**, or
- press the shutter-release button halfway or press the **Ⓜ** button between shots.

✓ During Shooting

A **Focus** icon is displayed in the control panel during shooting.

✓ Cautions: Focus Shift Photography

- The shutter speed and the time needed to record the picture may vary from shot to shot. As a result, the camera may be unable to take shots at the selected interval.
- Shooting ends when focus reaches infinity, and consequently depending on the focus position at the start of shooting, shooting may end before the selected number of shots has been taken.
- Regardless of the option selected for Custom Setting c3 [**Power off delay**] > [**Standby timer**], the standby timer will not expire while shooting is in progress.
- If you are using a flash, choose an interval longer than the time needed for the flash to charge. If the interval is too short, the flash may fire at less than the power needed for full exposure.
- If shooting cannot proceed at current settings, for example because shutter speed is set to "**Bulb**" or "**Time**", a warning will be displayed.
- Changing camera settings while focus shift photography is in progress may cause shooting to end.

✓ Focus Shift Photography: Restrictions

Focus-shift photography cannot be combined with some camera features, including:

- video recording,
 - long time-exposures ("Bulb" or "Time"),
 - the self-timer,
 - high-speed frame capture +,
 - bracketing,
 - multiple exposures,
 - HDR overlay,
 - interval-timer photography, and
 - time-lapse video recording.
-

Tip: Aperture

Given that pictures shot at very small apertures (high f-numbers) may lack definition, we recommend that you choose apertures wider (f-numbers lower) than $f/8$ – $f/11$.

Tip: Close-ups

Because focus depth is reduced at short focus distances, we recommend choosing smaller focus steps and increasing the number of shots when photographing subjects close to the camera.

The Video Recording Menu: Video Recording Options

Video Recording Menu

To view the video recording menu, select the  tab in the camera menus.

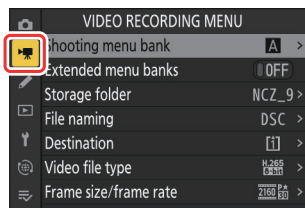

The options in the video recording menu are listed below, together with their default settings.

- **[Shooting menu bank]:** A
- **[Extended menu banks]:** OFF
- **[Storage folder]**
 - **[Rename]:** NCZ_9
 - **[Select folder by number]:** 100
 - **[Select folder from list]:** —
- **[File naming]:** DSC
- **[Destination]:** Slot 1
- **[Video file type]:** H.265 8-bit (MOV)
- **[Frame size/frame rate]:** 3840×2160; 30p
- **[Video quality (N-RAW)]:** High quality
- **[Image area]**
 - **[Choose image area]:** FX
 - **[DX crop alert]:** OFF
- **[Extended oversampling]:** OFF
- **[ISO sensitivity settings]**
 - **[Maximum sensitivity]:** 25600
 - **[Auto ISO control (mode M)]:** ON
 - **[ISO sensitivity (mode M)]:** 100
- **[White balance]:** Same as photo settings
- **[Set Picture Control]:** Same as photo settings
- **[Manage Picture Control]:** —
- **[HLG quality]**
 - **[Quick sharp]:** 0
 - **[Contrast]:** 0

- [Saturation]: 0
- [Hue]: 0
- [Active D-Lighting]: Off
- [High ISO NR]: Normal
- [Vignette control]: Normal
- [Diffraction compensation]: ON
- [Auto distortion control]: ON
- [Video flicker reduction]: Auto
- [High-frequency flicker reduction]: Off
- [Metering]: Matrix metering
- [Focus mode]: Full-time AF
- [AF-area mode]: Single-point AF
- [AF subject detection options]
 - [Subject detection]: Auto
 - [AF when subject not detected]: ON
- [Vibration reduction]: Same as photo settings
- [Electronic VR]: OFF
- [Microphone sensitivity]: Auto
- [Attenuator]: OFF
- [Frequency response]: Wide range
- [Wind noise reduction]: OFF
- [Mic jack plug-in power]: ON
- [Headphone volume]: 15
- [Timecode]
 - [Record timecodes]: Off
 - [Count-up method]: Record run
 - [Timecode origin]: —
 - [Drop frame]: ON
- [External rec. cntrl (HDMI)]: OFF
- [Hi-Res Zoom]: OFF

Shooting Menu Bank

MENU button ➡  video recording menu

Select a shooting menu bank ("A" through "D"). More information is available in the section devoted to the **[Shooting menu bank]** item in the photo shooting menu ([📖 439](#)).

Extended Menu Banks

MENU button ➡  video recording menu

Select **[ON]** to include exposure settings in the information recorded in each of the four shooting menu banks. More information is available in the section devoted to the **[Extended menu banks]** item in the photo shooting menu ([📖 441](#)).

Storage Folder

MENU button ➡  video recording menu

Choose the folder in which subsequent pictures will be stored. More information is available in the section devoted to the **[Storage folder]** item in the photo shooting menu ([book 442](#)).

"Storage Folder"

Changes to **[Storage folder]** in the photo shooting menu apply in the video recording menu and *vice versa*.

File Naming

MENU button ➡  video recording menu

Choose the three-letter prefix used in naming the files in which videos are stored; the default prefix is "DSC" ([📖 446](#)).

Destination

MENU button ➡  video recording menu

Choose the slot to which videos are recorded when two memory cards are inserted.

- The menu shows the time available on each card.
- Recording ends automatically when no time remains on the current card.

Video File Type

MENU button ➡  video recording menu

Choose the video file type. For more information, see the section on “Video File Types” ([📖 202](#)) in the “Video Recording” chapter.

Frame Size/Frame Rate

MENU button ➡  video recording menu

Choose the video frame size (in pixels) and frame rate. For more information, see the section on “Video Frame Size and Rate Options” ([📖 205](#)) in the “Video Recording” chapter.

Video Quality (N-RAW)

MENU button ➡  video recording menu

The quality for videos recorded with **[N-RAW 12-bit (NEV)]** selected for **[Video file type]** in the video recording menu can be selected from **[High quality]** and **[Normal]**.

Image Area

MENU button ➡  video recording menu

Choose a video crop. For more information, see the section on “Video Image Area Options” ([📖 212](#)) in the “Video Recording” chapter.

Extended Oversampling

MENU button ➡  video recording menu

Selecting **[ON]** optimizes image readout for improved image quality.

- Extended oversampling applies when **[3840×2160; 60p]** or **[3840×2160; 50p]** is selected for **[Frame size/frame rate]** and **[FX]** is selected for **[Image area] > [Choose image area]** in the video recording menu.
- Note that the drain on the battery increases when **[ON]** is selected.

ISO Sensitivity Settings

MENU button → video recording menu

Adjust the following ISO sensitivity settings for use in video mode.

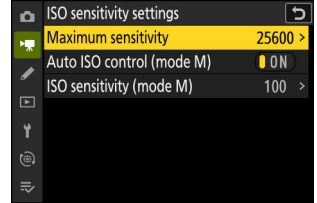

Option	Description
[Maximum sensitivity]	<ul style="list-style-type: none">• Choose the upper limit for auto ISO sensitivity control from values between ISO 200 and Hi 2.0.• The selected value serves as the upper limit for ISO sensitivity in modes P, S, and A and when [ON] is selected for [Auto ISO control (mode M)] in mode M.
[Auto ISO control (mode M)]	<ul style="list-style-type: none">• [ON]: Enable auto ISO sensitivity control in mode M.• [OFF]: Use the value selected for [ISO sensitivity (mode M)].• Regardless of the option selected, auto ISO sensitivity control is used in modes other than M.
[ISO sensitivity (mode M)]	Choose the ISO sensitivity for mode M from values between ISO 64 and Hi 2.0.

☑ Cautions: Auto ISO Sensitivity Control

- At high ISO sensitivities, “noise” (randomly-spaced bright pixels, fog, or lines) may increase.
- At high ISO sensitivities, the camera may have difficulty focusing.
- The foregoing can be prevented by choosing a lower value for [ISO sensitivity settings] > [Maximum sensitivity].

White Balance

MENU button ➡  video recording menu

Choose the white balance for videos. Select [**Same as photo settings**] to use the option currently selected for photos ([📖 151](#)).

Set Picture Control

MENU button ➡  video recording menu

Choose a Picture Control for videos. Select [**Same as photo settings**] to use the option currently selected for photos ([📖 183](#)).

Manage Picture Control

MENU button →  video recording menu

Save modified Picture Controls as custom Picture Controls ([📖 189](#)).

HLG Quality

MENU button ➡  video recording menu

Adjust HLG video image processing options for use when **[HLG]** is chosen as the tone mode for **[Video file type]** > **[H.265 10-bit (MOV)]** in the video recording menu.

Option	Description
[Quick sharp]	Use [Quick sharp] to quickly adjust levels for balanced [Sharpening] , [Mid-range sharpening] , and [Clarity] . These parameters can also be adjusted individually.
[Sharpening]	Control the sharpness of details and outlines.
[Mid-range sharpening]	Adjust the sharpness of patterns and lines in the range between [Sharpening] and [Clarity] .
[Clarity]	Adjust overall sharpness and the sharpness of thicker outlines without affecting brightness or dynamic range.
[Contrast]	Adjust contrast.
[Saturation]	Control the vividness of colors.
[Hue]	Adjust hue.

Active D-Lighting

MENU button ➡ 果 video recording menu

Preserve details in highlights and shadows, creating videos with natural contrast.

Option		Description
☞ H*	[Extra high]	Choose the amount of Active D-Lighting performed from (in order from high to low) [Extra high], [High], [Normal], and [Low].
☞ H	[High]	
☞ N	[Normal]	
☞ L	[Low]	
	[Off]	Active D-Lighting off.

High ISO NR

MENU button ➡  video recording menu

Reduce “noise” (randomly-spaced bright pixels) in videos recorded at high ISO sensitivities ([📖 462](#)).

Vignette Control

MENU button ➡  video recording menu

Reduce vignetting in videos ([📖 463](#)).

Vignette Control

Changes to [**Vignette control**] in the photo shooting menu apply in the video recording menu and *vice versa*.

Diffraction Compensation

MENU button ➡  video recording menu

Choose whether to reduce diffraction in videos ([📖 464](#)).

Diffraction Compensation

Changes to [**Diffraction compensation**] in the photo shooting menu apply in the video recording menu and *vice versa*.

Auto Distortion Control

MENU button ➡  video recording menu

Choose whether to reduce barrel and pin-cushion distortion in videos ([📖 465](#)).

Auto Distortion Control

Changes to [**Auto distortion control**] in the photo shooting menu apply in the video recording menu and *vice versa*.

Video Flicker Reduction

MENU button ➡  video recording menu

Reduce flicker and banding in the shooting display and in footage recorded under fluorescent or mercury-vapor lighting.

- Choose **[Auto]** to allow the camera to automatically choose the correct frequency.
- If **[Auto]** fails to produce the desired results, select **[50 Hz]** or **[60 Hz]** according to the frequency of the local power supply. Choose **[50 Hz]** for areas with a 50 Hz power supply, **[60 Hz]** for areas with a 60 Hz power supply.
- Changes to **[Video flicker reduction]** also apply to the shooting display in photo mode.

Cautions: [Video Flicker Reduction]

- If **[Auto]** fails to produce the desired results and you are unsure as to the frequency of the local power supply, test both the 50 and 60 Hz options and choose the one that produces the best results.
- Flicker reduction may not produce the desired results if the subject is very bright. If this is the case, try choosing a smaller aperture (higher f-number).
- Flicker reduction may fail to produce the desired results in modes other than **M**. If this is the case, select mode **M** and choose a shutter speed adapted to the frequency of the local power supply:
 - 50Hz: $\frac{1}{100}$ s, $\frac{1}{50}$ s, $\frac{1}{25}$ s
 - 60Hz: $\frac{1}{125}$ s, $\frac{1}{60}$ s, $\frac{1}{30}$ s

High-Frequency Flicker Reduction

MENU button ➔  video recording menu

Selecting [**On (shutter speed fine-tuning)**] allows shutter speeds between $\frac{1}{8000}$ and $\frac{1}{30}$ s to be adjusted in smaller increments in mode **M**, letting speeds that keep flicker to a minimum be found by viewing the preview in the shooting display. More information is available in the section devoted to the [**High-frequency flicker reduction**] item in the photo shooting menu ([book 468](#)).

Metering

MENU button ➡  video recording menu

Choose how the camera meters exposure in video mode. [**Spot metering**] is not available in the video recording menu ([📖 470](#)).

Focus Mode

MENU button ➡  video recording menu

Choose a focus mode for video recording ([📖 110](#)).

AF-Area Mode

MENU button ➡  video recording menu

Choose an AF-area mode for video recording ([📖 112](#)).

AF Subject Detection Options

MENU button ➡  video recording menu

Subject Detection

Choose the type of subject to which the camera gives priority when focusing in video mode ([📖 116](#)).

AF When Subject Not Detected

Choose whether the camera focuses if unable to detect a subject of the type selected for [**Subject detection**] when [**Full-time AF**] is selected for focus mode.

- If [**ON**] is selected, the camera will initiate autofocus whether or not a subject of the selected type is detected.
- Select [**OFF**] to disable autofocus when no subject of the selected type is detected.

Vibration Reduction

MENU button ➡  video recording menu

Adjust vibration reduction settings for video mode. Select [**Same as photo settings**] to use the option currently selected for photos ([📖 477](#)).

Electronic VR

MENU button ➡  video recording menu

Choose whether to enable electronic vibration reduction in video mode.

Caution: Electronic Vibration Reduction

[**Electronic VR**] is fixed at [**OFF**] while:

- [**N-RAW 12-bit (NEV)**] or [**ProRes RAW HQ 12-bit (MOV)**] is selected for [**Video file type**] in the video recording menu,
 - 7680 × 4320 is selected for frame size, or
 - 120p or 100p is selected for frame rate.
 - [**ON**] is selected for [**Hi-Res Zoom**] in the video recording menu.
-

Microphone Sensitivity

MENU button → video recording menu

Turn built-in or external microphones on or off or adjust microphone sensitivity.

Option	Description
[Auto]	Microphone sensitivity is adjusted automatically.
[Manual]	Adjust microphone sensitivity manually. Choose from values of from [1] to [20]. The higher the value, the higher the sensitivity; the lower the value, the lower the sensitivity.
[Microphone off]	Turn sound recording off.

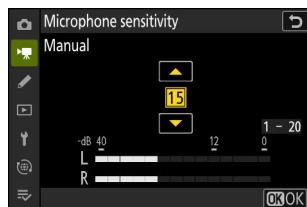

- If the sound level is displayed in red, the volume is too high. Reduce microphone sensitivity.

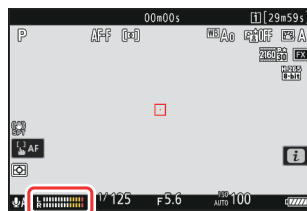

✓ Videos Without Sound

Videos recorded with [Microphone off] selected for [Microphone sensitivity] are indicated by a  icon.

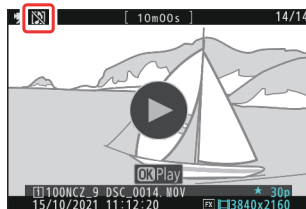

Attenuator



MENU button →  video recording menu

Select **[ON]** to reduce microphone gain and prevent audio distortion when recording videos in loud environments.

Frequency Response

MENU button ➡  video recording menu

Choose the range of frequencies to which built-in and external microphones respond.

Option		Description
 WIDE	[Wide range]	Record a wide range of frequencies. Choose for everything from music to the bustling hum of a city street.
 VOICE	[Vocal range]	Choose for human voices.

Wind Noise Reduction

MENU button →  video recording menu

Select **[ON]** to enable the low-cut filter, reducing noise produced by wind blowing over the built-in microphone. Note that other sounds may also be affected.

Selecting **[ON]** for **[Wind noise reduction]** has no effect on optional stereo microphones. Wind-noise reduction for optional stereo microphones that support this feature can be enabled or disabled using microphone controls.

Mic Jack Plug-in Power



MENU button ➡  video recording menu

The camera does not provide power to external microphones when **[OFF]** is selected.

- To prevent noise from interference generated by the power supply, we recommend turning plug-in power **[OFF]** when using microphones that do not require plug-in power.
- For information on whether your microphone requires plug-in power, consult the manufacturer.

Headphone Volume

MENU button →  video recording menu

Press  or  to adjust headphone volume.

Timecode

MENU button ➡  video recording menu

Choose whether to record time codes giving the hour, minute, second, and frame number for each frame when shooting videos. Time codes are not included in videos shot with **[H.264 8-bit (MP4)]** selected for **[Video file type]** in the video recording menu.

Option	Description
[Record timecodes]	<ul style="list-style-type: none">• [On]: Record time codes. The time code appears in the shooting display.• [On (with HDMI output)]: Time codes will be included with footage saved to external recorders connected to the camera via an HDMI cable. The camera supports Atomos SHOGUN, NINJA, and SUMO-series Monitor recorders.• [Off]: Time codes are not recorded.
[Count-up method]	<ul style="list-style-type: none">• [Record run]: Time codes are incremented only while recording is in progress.• [Free run]: Time codes are incremented continuously. Time codes continue to be incremented while the camera is off.
[Timecode origin]	<ul style="list-style-type: none">• [Reset]: Reset the time code to 00:00:00.00.• [Reset using remote]: The time code can be reset by pressing the shutter-release button on an optional WR-T10 wireless remote controller (📖 559).• [Enter manually]: Enter the hour, minute, second, and frame number manually.• [Current time]: Set the time code to the current time as reported by the camera clock. Before proceeding, select [Time zone and date] in the setup menu and make sure that the camera clock is set to the correct time and date.
[Drop frame]	Select [ON] to compensate for discrepancies between the frame count and the actual recording time at frame rates of 30 and 60 fps.

✔ **Caution: HDMI Devices**

Selecting **[On (with HDMI output)]** for **[Record timecodes]** may disrupt footage output to HDMI devices.

“Reset Using Remote”

This option allows the time code to be reset by pressing the shutter-release button on an optional WR-T10 paired with an optional WR-R11a or WR-R10 wireless remote controller attached to the camera.

- Selecting **[Reset using remote]** displays a time-code reset dialog. Press the shutter-release button on the WR-T10 to reset the time code.
- Pairing a single WR-T10 with multiple WR-R11a/WR-R10 wireless remote controllers allows the time codes for multiple cameras to be reset simultaneously with a single press of the WR-T10's shutter-release button. The time codes for multiple cameras can thus be synchronized, making editing easier.

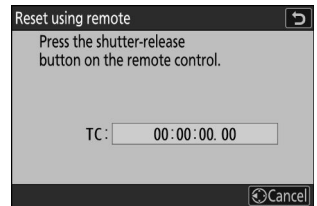

✔ **The Time-Code Reset Dialog**

Pressing the camera shutter-release button all the way down while the time-code reset dialog is displayed resets the time code. No photograph will be taken.

External Rec. Cntrl (HDMI)

MENU button ➡  video recording menu

Selecting [**ON**] allows camera controls to be used to start and stop recording on the external recorder. For more information, see the section on “Recorders” ([book 297](#)) in the “Connecting to HDMI TVs and Recorders” chapter.

Hi-Res Zoom

MENU button ➡  video recording menu

Selecting **[ON]** allows you to zoom in on your subject with no loss in resolution without using a zoom lens. For more information, see the section on “Hi-Res Zoom” ([📖 223](#)) in the “Video Recording” chapter.

Custom Settings: Fine-Tuning Camera Settings

Custom Settings Menu

To view Custom Settings, select the  tab in the camera menus.

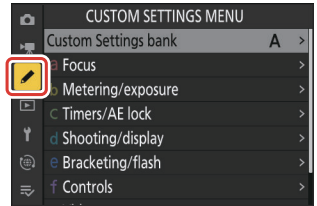

Custom Settings are used to customize camera settings to suit individual preferences. The Custom Settings menu is divided into two levels.

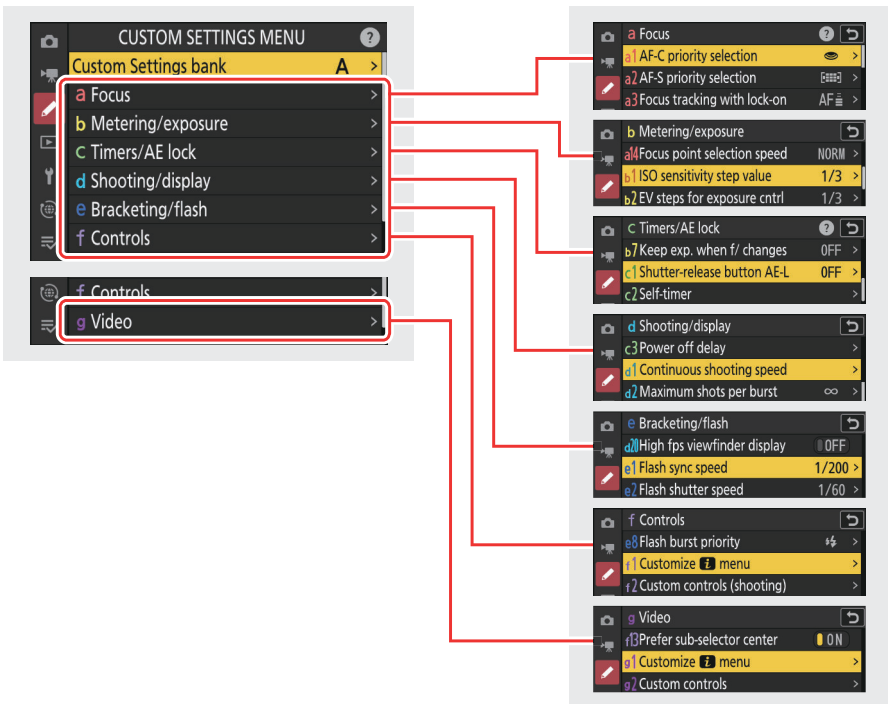



The options in the Custom Settings menu are listed below, together with their default settings. ¹

- **[Custom Settings bank]: A**
- **a [Focus]**
 - a1 **[AF-C priority selection]:** Release
 - a2 **[AF-S priority selection]:** Focus
 - a3 **[Focus tracking with lock-on]**
 - **[Blocked shot AF response]:** 3
 - **[Subject motion]:** Steady
 - a4 **[Focus points used]:** All points
 - a5 **[Store points by orientation]:** Off
 - a6 **[AF activation]:** Shutter/AF-ON
 - a7 **[Focus point persistence]:** Auto
 - a8 **[Limit AF-area mode selection]**
 - **[Pinpoint AF]:**
 - **[Single-point AF]:** (cannot be deselected)
 - **[Dynamic-area AF (S)]:**
 - **[Dynamic-area AF (M)]:**
 - **[Dynamic-area AF (L)]:**
 - **[Wide-area AF (S)]:**
 - **[Wide-area AF (L)]:**
 - **[Wide-area AF (C1)]:**
 - **[Wide-area AF (C2)]:**
 - **[3D-tracking]:**
 - **[Auto-area AF]:**
 - a9 **[Focus mode restrictions]:** No restrictions
 - a10 **[Focus point wrap-around]:** OFF
 - a11 **[Focus point display]**
 - **[Manual focus mode]:** ON
 - **[Dynamic-area AF assist]:** ON
 - **[AF-C in-focus display]:** OFF
 - **[3D-tracking focus point color]:** White
 - a12 **[Built-in AF-assist illuminator]:** ON
 - a13 **[Focus peaking]**
 - **[Focus peaking display]:** OFF
 - **[Focus peaking sensitivity]:** 2 (standard)
 - **[Focus peaking highlight color]:** Red
 - a14 **[Focus point selection speed]:** Normal
 - a15 **[Manual focus ring in AF mode] ²:** ON
- **b [Metering/exposure]**
 - b1 **[ISO sensitivity step value]:** 1/3 step
 - b2 **[EV steps for exposure cntrl]:** 1/3 EV steps (comp. 1/3 EV)
 - b3 **[Easy exposure compensation]:** Off
 - b4 **[Matrix metering face detection]:** ON

- b5 **[Center-weighted area]**: Standard
- b6 **[Fine-tune optimal exposure]**
 - **[Matrix metering]**: 0
 - **[Center-weighted metering]**: 0
 - **[Spot metering]**: 0
 - **[Highlight-weighted metering]**: 0
- b7 **[Keep exp. when f/ changes]**: Exposure maintenance off
- c **[Timers/AE lock]**
 - c1 **[Shutter-release button AE-L]**: Off
 - c2 **[Self-timer]**
 - **[Self-timer delay]**: 10 s
 - **[Number of shots]**: 1
 - **[Interval between shots]**: 0.5 s
 - c3 **[Power off delay]**
 - **[Playback]**: 10 s
 - **[Menus]**: 1 min
 - **[Picture review]**: 4 s
 - **[Standby timer]**: 30 s
- d **[Shooting/display]**
 - d1 **[Continuous shooting speed]**
 - **[Continuous high-speed]**: 20 fps
 - **[Continuous low-speed]**: 5 fps
 - d2 **[Maximum shots per burst]**: ∞
 - d3 **[Limit release mode selection]**
 - **[Single frame]**: ✓ (cannot be deselected)
 - **[Continuous L]**:
 - **[Continuous H]**:
 - **[C30]**:
 - **[C60]**:
 - **[C120]**:
 - **[Self-timer]**:
 - d4 **[Pre-Release Capture options]**
 - **[Pre-release burst]**: None
 - **[Post-release burst]**: Max.
 - d5 **[Sync. release mode options]**: Sync
 - d6 **[Extended shutter speeds (M)]**: OFF
 - d7 **[Limit selectable image area]**
 - **[FX (36×24)]**: ✓ (cannot be deselected)
 - **[DX (24×16)]**:
 - **[1:1 (24×24)]**:
 - **[16:9 (36×20)]**:
 - d8 **[File number sequence]**: On
 - d9 **[View mode (photo Lv)]**: Show effects of settings

- [**Show effects of settings**]: Only when flash is not used
- [**Adjust for ease of viewing**]: Auto
- d10 [**Starlight view (photo Lv)**]: OFF
- d11 [**Warm display colors**]
 - [**Warm display color options**]: Off
 - [**Warm color display brightness**]: 0
- d12 [**LCD illumination**]: OFF
- d13 [**View all in continuous mode**]: ON
- d14 [**Release timing indicator**]
 - [**Indicator type**]: Type B
 - [**Type A auto restore delay**]: 1/6 s
- d15 [**Image frame**]: ON
- d16 [**Grid type**]: 3×3
- d17 [**Virtual horizon type**]: Type A
- d18 [**Custom monitor shooting display**]
 - [**Display 1**]: ✓ (cannot be deselected)
 - [**Display 2**]: ☑
 - [**Display 3**]: ☑
 - [**Display 4**]: ☑
 - [**Display 5**]: ☑
- d19 [**Custom viewfinder shooting display**]
 - [**Display 1**]: ✓ (cannot be deselected)
 - [**Display 2**]: ☑
 - [**Display 3**]: ☑
 - [**Display 4**]: ☑
- d20 [**High fps viewfinder display**]: OFF
- e [**Bracketing/flash**]
 - e1 [**Flash sync speed**]: 1/200 s
 - e2 [**Flash shutter speed**]: 1/60 s
 - e3 [**Exposure comp. for flash**]: Entire frame
 - e4 [**Auto ½ ISO sensitivity control**]: Subject and background
 - e5 [**Modeling flash**]: ON
 - e6 [**Auto bracketing (mode M)**]: Flash/speed
 - e7 [**Bracketing order**]: MTR > under > over
 - e8 [**Flash burst priority**]: Prioritize precise flash control
- f [**Controls**]
 - f1 [**Customize  menu**]: Set Picture Control, White balance, Image quality, Image size, AF-area mode/subj. detection, Focus mode, Metering, Vibration reduction, Shooting menu bank, Custom controls (shooting), Airplane mode, View memory card info
 - f2 [**Custom controls (shooting)**]
 - [**]: Shooting menu bank**
 - [**]: Choose image area**
 - [**]: Live view info display off**

- [**Fn button for vertical shooting**]: Exposure compensation
- [**Vertical ISO sensitivity button**]: ISO sensitivity
- [**AF-ON button**]: AF-ON
- [**Protect/Fn4 button**]: Set Picture Control
- [**DISP button**]: Cycle live view info display
- [**Sub-selector center**]: AE/AF lock
- [**OK button**]: Select center focus point
- [**Audio button**]: None
- [**QUAL button**]: Image quality/size
- [**Vertical multi selector center**]: AE/AF lock
- [**AF-ON button for vertical shooting**]: Same as AF-ON button
- [**Video record button**]: None
- [**Exposure compensation button**]: Exposure compensation
- [**ISO sensitivity button**]: ISO sensitivity
- [**Command dials**]
 - [**Exposure setting**]: P: --/P*, S: --/Tv, A: Av/--, M: Av/Tv
 - [**Focus/AF-area mode selection**]: []/AF/MF
 - [**Sub-command dial zoom role**]: Exposure setting
- [**Lens Fn button**]: AE/AF lock
- [**Lens Fn2 button**]: AF-ON
- [**Lens Fn ring (counterclockwise)**]: Recall focus position
- [**Lens Fn ring (clockwise)**]: Recall focus position
- [**Lens memory set button**]: Save focus position
- [**Lens control ring**]: (Varies with lens)
- f3 [**Custom controls (playback)**]
 - [**Fn1 button**]: None
 - [**Fn2 button**]: None
 - [**Fn3 button**]: None
 - [**Fn button for vertical shooting**]: None
 - [**Protect/Fn4 button**]: Protect
 - [**DISP button**]: Cycle info display
 - [**Audio button**]: Voice memo
 - [**OK button**]: Zoom on/off
 - [**WB button**]: Select for upload to computer
 - [**QUAL button**]: Rating
 - [**Main command dial**]
 - [**Frame advance**]: 1 frame
 - [**Video playback**]: 10 frames
 - [**Vertical shooting multi selector**]: Unswitch
 - [**Video record button**]: None
 - [**Sub-command dial**]
 - [**Frame advance**]: 1 frame
 - [**Video playback**]: 10 s

- f4 **[Control lock]**
 - **[Shutter speed lock]**: OFF
 - **[Aperture lock]**: OFF
 - **[Focus-point lock]**: OFF
- f5 **[Reverse dial rotation]**
 - **[Exposure compensation]**: □
 - **[Shutter speed/aperture]**: □
- f6 **[Release button to use dial]**: OFF
- f7 **[Reverse indicators]**: 
- f8 **[Reverse ring for focus]**: OFF
- f9 **[Focus ring rotation range]**: Non-linear
- f10 **[Control ring response]**: High
- f11 **[Switch focus/control ring roles]**: OFF
- f12 **[Full-frame playback flicks]**
 - **[Flick up]**: None
 - **[Flick down]**: None
 - **[Flick advance direction]**: Left→Right
- f13 **[Prefer sub-selector center]**: ON
- **g [Video]**
 - g1 **[Customize  menu]**: Set Picture Control, White balance, Frame size/frame rate, Microphone sensitivity, AF-area mode/subj. detection, Focus mode, Electronic VR, Vibration reduction, Shooting menu bank, Custom controls, Airplane mode, Destination
 - g2 **[Custom controls]**
 - **[Fn1 button]**: Shooting menu bank
 - **[Fn2 button]**: Choose image area
 - **[Fn3 button]**: Live view info display off
 - **[Fn button for vertical shooting]**: Exposure compensation
 - **[Vertical ISO sensitivity button]**: ISO sensitivity
 - **[Focus mode button]**: Focus mode/AF-area mode
 - **[Protect/Fn4 button]**: Set Picture Control
 - **[AF-ON button]**: AF-ON
 - **[Sub-selector center]**: AE/AF lock
 - **[DISP button]**: Cycle live view info display
 - **[Audio button]**: Microphone sensitivity
 - **[OK button]**: Select center focus point
 - **[Vertical multi selector center]**: AE/AF lock
 - **[QUAL button]**: None
 - **[Video record button]**: Record videos
 - **[AF-ON button for vertical shooting]**: Same as AF-ON button
 - **[ISO sensitivity button]**: ISO sensitivity
 - **[Exposure compensation button]**: Exposure compensation
 - **[Shutter-release button]**: None
 - **[Command dials]**

- [Exposure setting]: A: Av/Tv--, M: Av/Tv
- [Focus/AF-area mode selection]: AF/MF
- [Sub-command dial zoom role]: Exposure setting
- [Lens Fn button]: AE/AF lock
- [Lens Fn2 button]: AF-ON
- [Lens Fn ring (counterclockwise)]: Recall focus position
- [Lens Fn ring (clockwise)]: Recall focus position
- [Lens memory set button]: Save focus position
- [Lens control ring]: (Varies with lens)
- g3 [Control lock]
 - [Shutter speed lock]: OFF
 - [Aperture lock]: OFF
 - [Focus-point lock]: OFF
- g4 [Limit AF-area mode selection]
 - [Single-point AF]: (cannot be deselected)
 - [Wide-area AF (S)]:
 - [Wide-area AF (L)]:
 - [Wide-area AF (C1)]:
 - [Wide-area AF (C2)]:
 - [Subject-tracking AF]:
 - [Auto-area AF]:
- g5 [Focus mode restrictions]: No restrictions
- g6 [AF speed]: 0
 - [When to apply]: Always
- g7 [AF tracking sensitivity]: 4
- g8 [Hi-Res Zoom speed]: Standard
- g9 [Fine ISO control (mode M)]: Off
- g10 [Extended shutter speeds (mode M)]: OFF
- g11 [View assist]: OFF
- g12 [Zebra pattern]
 - [Pattern tone range]: Zebra pattern off
 - [Pattern]: Pattern 1
 - [Highlight threshold]: 250
 - [Mid-tone range]: Value: 160; range: ± 10
- g13 [Limit zebra pattern tone range]: No restrictions
- g14 [Grid type]: 3 \times 3
- g15 [Brightness information display]: Histogram
- g16 [Custom monitor shooting display]
 - [Display 1]: (cannot be deselected)
 - [Display 2]:
 - [Display 3]:
 - [Display 4]:
- g17 [Custom viewfinder shooting display]

- **[Display 1]:** ✓ (cannot be deselected)
- **[Display 2]:** ☑
- **[Display 3]:** ☑
- g18 **[Red REC frame indicator]:** ON

- 1 Items modified from default values are indicated by asterisks ("*").
- 2 Available with compatible lenses only.

Custom Settings Bank

MENU button ➔ Custom Settings menu

Custom Settings are stored in one of four banks (banks "A" through "D") that can be selected using [**Custom Settings bank**]. Changes to settings made while one bank is selected are not applied to the remaining banks.

Renaming Custom Settings Banks

A descriptive caption can be added to the bank name ("A", "B", "C", or "D") by highlighting the bank, pressing **Ⓢ**, and selecting [**Rename**]. Captions can be up to 20 characters long.

Copying Custom Settings Banks

To create a copy of a custom settings bank, highlight the bank, press **Ⓢ**, select [**Copy**], and choose a destination for the copy.

Restoring Default Settings

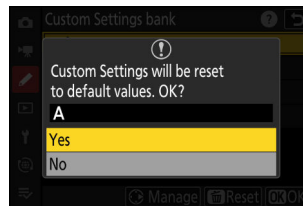
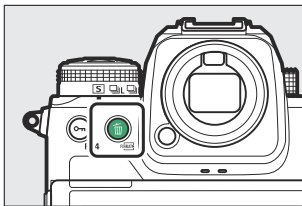

You can restore default settings for a selected Custom Settings bank. To do so, highlight the bank and press **Ⓢ** (RESET); a confirmation dialog will be displayed. Highlight [**Yes**] and press **Ⓢ** to restore default settings for the selected bank.



a1: AF-C Priority Selection

MENU button ➔✎ Custom Settings menu



Choose whether photos can be taken before the camera focuses when **AF-C** is selected.

Option		Description
	[Release]	Photos can be taken whenever the shutter-release button is pressed (release priority).
	[Focus + release]	Priority is normally given to release, but if the subject is dark or low contrast and the camera is in continuous-release mode, priority will be given to focus for the first shot in each series. For the remaining shots, priority will be given to release regardless of focus. This helps ensure that the first shot in each series is in focus.
	[Focus]	Photos can be taken only when the camera is in focus (focus priority).

a2: AF-S Priority Selection

MENU button ➔✎ Custom Settings menu

Choose whether photos can be taken before the camera focuses when **AF-S** is selected.

Option	Description
 [Release]	Photos can be taken whenever the shutter-release button is pressed (release priority).
 [Focus]	Photos can be taken only when the camera is in focus (focus priority).

a3: Focus Tracking with Lock-On

MENU button ➔ Custom Settings menu

Choose how quickly focus responds if something passes between the subject and the camera when **AF-C** is selected for the focus mode.

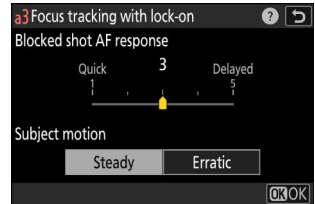

Blocked Shot AF Response

- Choose [5] (**Delayed**) to help maintain focus on your original subject.
- Choose [1] (**Quick**) to make it easier to shift focus to objects crossing your field of view.
- Regardless of the option selected, blocked shot AF response functions in mode [3] when [3D-tracking] is selected for AF-area mode.
- If [Auto-area AF] is selected for AF-area mode, blocked shot AF response will function in mode [3] when [2] or [1] is selected.



Subject Motion

Option	Description
[Steady]	Choose for smooth focus when photographing subjects that approach the camera at a steady pace.
[Erratic]	Choose for improved response when photographing subjects prone to sudden starts and stops.

a4: Focus Points Used

MENU button ➔✎ Custom Settings menu

Choose the number of focus points available for manual focus-point selection when an option other than **[Auto-area AF]** is selected for AF-area mode.

	Option	Description
	[All points]	Every focus point available in the current AF-area mode can be selected. The number of points available varies with the AF-area mode.
	[Alternating points]	The number of available focus points is reduced to one quarter of the number available when [All points] is selected. Use for quick focus-point selection. The number of points available for [Pinpoint AF] is not affected.

a5: Store Points by Orientation

MENU button ➔ Custom Settings menu

Choose whether separate focus points can be selected for “wide” (landscape) orientation, for “tall” (portrait) orientation with the camera rotated 90° clockwise, and for “tall” orientation with the camera rotated 90° counterclockwise.

- Select **[Off]** to use the same focus point regardless of camera orientation.

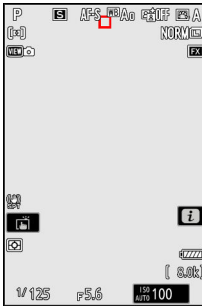

Camera rotated 90° counter-clockwise

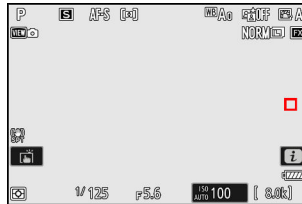

Landscape (wide) orientation

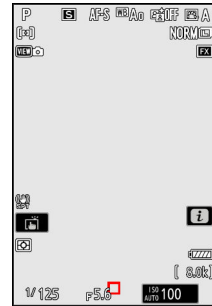
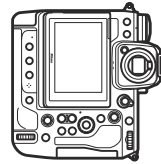

Camera rotated 90° clockwise

- Select [**Focus point**] to enable separate focus-point selection. To enable separate selection of both the focus point and AF-area mode, choose [**Focus point and AF-area mode**].

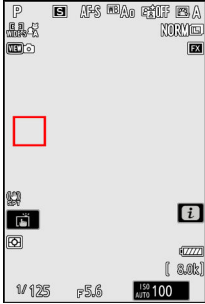

Camera rotated 90° counter-clockwise

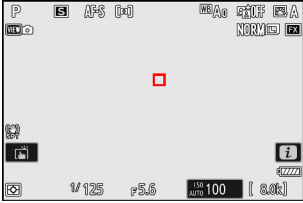

Landscape (wide) orientation

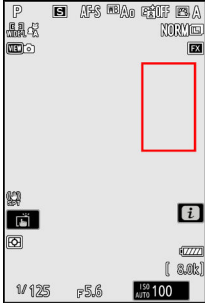
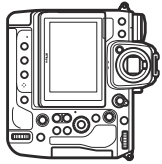

Camera rotated 90° clockwise

a6: AF Activation

MENU button ➡ Custom Settings menu

Choose whether the shutter-release button can be used to focus.

Option	Description
[Shutter/AF-ON]	The camera focuses when the shutter-release button is pressed halfway.
[AF-ON only]	The camera does not focus when the shutter-release button is pressed halfway.

- Highlighting [AF-ON only] and pressing  displays [Out-of-focus release] options.

Option	Description
[Enable]	Photos can be taken whenever the shutter-release button is pressed (release priority).
[Disable]	<ul style="list-style-type: none">• Photos can be taken only when the camera is in focus (focus priority).• Focus using the AF-ON button or other controls to which AF-ON has been assigned.

Caution: “Pinpoint AF”

If [Pinpoint AF] is selected for AF-area mode with Custom Setting a6 [AF activation] set to [AF-ON only] and [Disable] chosen for [Out-of-focus release], the shutter can be released whether or not the subject is in focus.

a7: Focus Point Persistence

MENU button ➡✎ Custom Settings menu

Choose whether the focus point selected by the camera continues in use after you change AF-area modes using a control to which **[AF-area mode]**, **[AF-area mode + AF-ON]**, **[Recall shooting functions]**, or **[Recall shooting functions (hold)]** has been assigned via Custom Setting f2 **[Custom controls (shooting)]**. This only applies if you change AF-area modes while focusing with the shutter-release button pressed halfway.

Option	Description
[Auto]	The focus point last chosen by the camera before you switched AF-area modes remains in effect.
[Off]	The focus point last chosen by the user is restored.

- Focus-point persistence applies if while the control is pressed, you switch from an AF-area mode such as **[Auto-area AF]** in which the focus point is chosen automatically to a mode in which the focus point is selected manually.

a8: Limit AF-Area Mode Selection

MENU button ➔✎ Custom Settings menu

Choose the AF-area modes that can be selected by pressing the focus-mode button and rotating the sub-command dial.

- Highlight options and press \odot or \ominus to select () or deselect (). Modes marked with a check () are available for selection via the sub-command dial.
- To complete the operation, press MENU.

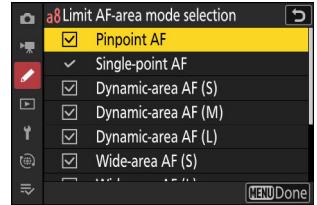

a9: Focus Mode Restrictions

MENU button → Custom Settings menu

Limit focus-mode selection to a single focus mode. If an option other than **[No restrictions]** is selected, rotating the main command dial while holding the focus-mode button will not change the focus mode.

a10: Focus Point Wrap-Around

MENU button ➔✎ Custom Settings menu

Choose whether focus-point selection “wraps around” from one edge of the display to another. If **[ON]** is selected, focus-point selection will “wrap around” from top to bottom, bottom to top, right to left, and left to right, so that, for example, pressing  when a focus point at the right edge of the display is highlighted selects the corresponding point at the left edge.

a11: Focus Point Display

MENU button ➔ Custom Settings menu

Choose from the focus point display options below.

Manual Focus Mode

Option	Description
[ON]	The focus point is displayed at all times in manual focus mode.
[OFF]	The focus point is displayed only during focus point selection.

Dynamic-Area AF Assist

Choose whether both the selected focus point and the surrounding focus points are displayed in dynamic-area AF mode.

Option	Description
[ON]	Display both the selected focus point and surrounding focus points.
[OFF]	Display only the selected focus point.

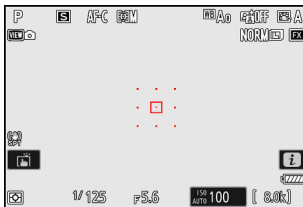

[ON] ([Dynamic-area AF (M)])

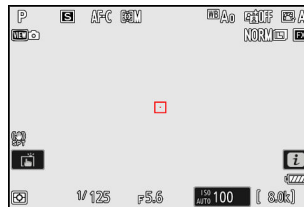

[OFF]

AF-C In-Focus Display

Choose whether the focus point changes color when the subject is in focus in focus mode **AF-C**.

Option	Description
[ON]	The focus point is displayed in green when the camera judges that the subject is in focus.
[OFF]	The active focus point is displayed in red or yellow at all times, whether or not the camera is in focus.

3D-Tracking Focus Point Color

The color of the focus point displayed when **[3D-tracking]** is selected for AF-area mode can be chosen from **[White]** and **[Red]**.

a12: Built-in AF-Assist Illuminator

MENU button ➔✎ Custom Settings menu

Choose whether the built-in AF-assist illuminator lights to assist the focus operation in photo mode when lighting is poor.

Option	Description
[ON]	In photo mode, the illuminator will light as required when AF-S is selected for focus mode.
[OFF]	The illuminator does not light to assist the focus operation. The camera may not be able to focus when lighting is poor.

✓ The AF-Assist Illuminator

- The AF-assist illuminator has a range of about 1–3 m (3 ft 4 in.–9 ft 10 in.).
- Remove lens hoods when using the illuminator.
- Do not obstruct the AF-assist illuminator while it is lit.

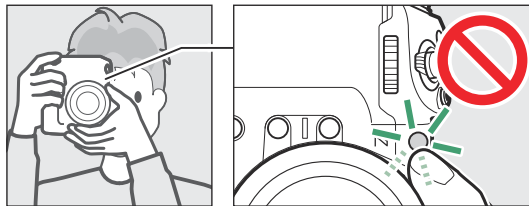

- Some lenses may block the light from the AF-assist illuminator at some or all focus distances. Information on these restrictions is available from the Nikon Download Center.

<https://downloadcenter.nikonimglib.com/>

a13: Focus Peaking

MENU button ➔✎ Custom Settings menu

When focus peaking is enabled in manual focus mode, objects that are in focus are indicated by colored outlines in the display. You can choose the color.

Focus Peaking Display

Select [ON] to enable focus peaking.

Focus Peaking Sensitivity

Choose focus peaking sensitivity from [3 (high sensitivity)], [2 (standard)], and [1 (low sensitivity)]. The higher the value, the greater the depth that will be shown as being in focus.

Focus Peaking Highlight Color

Choose the highlight color.

a14: Focus Point Selection Speed

MENU button ➔✎ Custom Settings menu

The speed at which the camera cycles through focus points while the multi selector or sub-selector is pressed can be chosen from [**Low**], [**Normal**], and [**High**].

a15: Manual Focus Ring in AF Mode

MENU button ➔✎ Custom Settings menu

Choose whether the lens focus ring can be used for manual focus in autofocus mode. Available with compatible lenses only.

Option	Description
[ON]	Autofocus can be over-ridden by rotating the lens focus ring (autofocus with manual override). The focus ring can be used for manual focus while the shutter-release button is pressed halfway. To refocus using autofocus, lift your finger from the shutter-release button and then press it halfway again.
[OFF]	The lens focus ring cannot be used for manual focus in autofocus mode.

b1: ISO sensitivity Step Value

MENU button ➔ Custom Settings menu

Choose whether changes to ISO sensitivity are made in increments of $\frac{1}{3}$ or 1 EV. If the value currently selected for ISO sensitivity is not available at the chosen setting, ISO sensitivity will be set to the nearest available value.

b2: EV Steps for Exposure Cntrl

MENU button ➔✎ Custom Settings menu

Select the increments used for adjustments to shutter speed, aperture, bracketing, and exposure and flash compensation.

- If [**1 EV steps (comp. 1/3 EV)**] is selected, changes to shutter speed, aperture, and bracketing will be made in increments of 1 EV and changes to exposure and flash compensation in increments of $\frac{1}{3}$ EV.

b3: Easy Exposure Compensation

MENU button ➡✎ Custom Settings menu

Choose whether the button is needed for exposure compensation.

Option	Description
[On (Auto reset)]	Exposure compensation can be adjusted using only a command dial. The setting selected with the command dial is reset when the camera turns off or the standby timer expires.
[On]	Exposure compensation can be adjusted using only a command dial. Exposure compensation is not reset when the camera turns off or the standby timer expires.
[Off]	Exposure compensation is set by pressing the <input checked="" type="checkbox"/> button and rotating a command dial.

- This option takes effect in modes **P**, **S**, and **A**. Easy exposure compensation is not available in mode **M**.
- The command dial used varies with the mode.

b4: Matrix Metering Face Detection

MENU button ➔✎ Custom Settings menu

Choose whether exposure is adjusted for the faces of human portrait subjects detected by the camera when **[Matrix metering]** is selected.

Option	Description
[ON]	The camera adjusts exposure for faces.
[OFF]	Exposure is not adjusted according to whether faces have been detected.

b5: Center-Weighted Area

MENU button ➡✎ Custom Settings menu

When [**Center-weighted metering**] is selected, the camera assigns the greatest weight to an area in the center of the shooting display when setting exposure.

Option		Description
SMALL	[Small]	The camera assigns the greatest weight to an area equivalent to a circle 8 mm in diameter.
STNDRD	[Standard]	The camera assigns the greatest weight to an area equivalent to a circle 12 mm in diameter.
AVG	[Average]	Weighting is based on the average of the entire frame.

b6: Fine-Tune Optimal Exposure

MENU button ➔ Custom Settings menu

Use this option to fine-tune the exposure value selected by the camera; exposure can be fine-tuned separately for each metering method. Exposure can be adjusted up for brighter exposures or down for darker exposures in the range +1 to -1 EV in steps of $\frac{1}{6}$ EV. The default is zero.

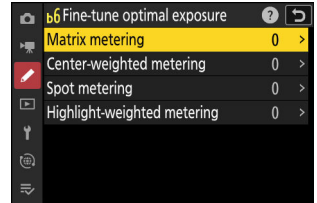

✓ Fine-Tuning Exposure

- Custom Setting b6 [**Fine-tune optimal exposure**] fine-tunes exposure separately for each Custom Settings bank. Be aware of different fine-tuning values for Custom Setting b6 when switching banks.
- Regardless of the option selected for Custom Setting b6 [**Fine-tune optimal exposure**], the exposure compensation icon (☒) will not be displayed. The only way to determine how much exposure has been altered is to view the amount in the fine-tuning menu for Custom Setting b6.
- The values selected are not affected by two-button resets.

b7: Keep Exp. When f/ Changes

MENU button ➔✎ Custom Settings menu



When **[OFF]** is selected for **[ISO sensitivity settings]** > **[Auto ISO sensitivity control]** in the photo shooting menu in mode **M**, actions such as switching to a lens with a different aperture range may cause unintended changes to aperture. If an option other than **[Exposure maintenance off]** is selected for **[Keep exp. when f/ changes]**, the camera will adjust shutter speed or ISO sensitivity to maintain exposure at its current value.

- Other cases in which settings may be automatically adjusted to maintain exposure include when:
 - lenses with different maximum apertures at minimum and maximum zoom are zoomed in or out,
or
 - the focus distance changes while a micro lens is attached.
- The setting adjusted to maintain exposure when aperture changes can be chosen from **[Shutter speed]** and **[ISO sensitivity]**. Select **[Exposure maintenance off]** to disable this feature.
- Depending on the lens, the camera may be unable to maintain current exposure at some settings.
- Exposure maintenance is not available during video recording.

c1: Shutter-Release Button AE-L

MENU button ➡✎ Custom Settings menu



Choose whether exposure locks when the shutter-release button is pressed.

Option		Description
 ON	[On (half press)]	Pressing the shutter-release button halfway locks exposure.
 ON	[On (burst mode)]	Exposure only locks while the shutter-release button is pressed all the way down.
[Off]		Pressing the shutter-release button does not lock exposure.

c2: Self-Timer

MENU button ➡ Custom Settings menu

Choose the length of the shutter release delay, the number of shots taken, and the interval between shots in self-timer mode.

Option	Description
[Self-timer delay]	Choose the length of the shutter-release delay.
[Number of shots]	Press  and  to choose the number of shots taken each time the shutter-release button is pressed; choose from values of from 1 to 9.
[Interval between shots]	Choose the interval between shots when [Number of shots] is more than 1.

c3: Power Off Delay

MENU button ➡ Custom Settings menu

Choose how long the monitor or viewfinder remains on when no operations are performed.

- Different settings can be chosen for [**Playback**], [**Menus**], [**Picture review**], and [**Standby timer**].
- [**Standby timer**] determines how long the control panel and the monitor or viewfinder display remain on after the shutter-release button is pressed halfway. The monitor and viewfinder dim a few seconds before the standby timer expires. If [**10 s**] is selected, the timer will be extended to 20 seconds while the **i** menu is displayed.
- Longer power-off delays reduce battery endurance.

d1: Continuous Shooting Speed

MENU button ➡✎ Custom Settings menu

Choose the frame advance rate for continuous high-speed and continuous low-speed modes.

Option	Description
[Continuous high-speed]	Choose the frame rate for continuous high-speed release mode from options ranging from [20 fps] to [10 fps].
[Continuous low-speed]	Choose the frame rate for continuous low-speed release mode from options ranging from [10 fps] to [1 fps]. <ul style="list-style-type: none">• The actual frame rate when [8 fps] is selected is 7.5 fps.

d2: Maximum Shots per Burst

MENU button ➔✎ Custom Settings menu

The maximum number of shots that can be taken in a single burst in continuous release modes can be set to “∞” (no limit) or to any value between 1 and 200.



- Note that regardless of the option selected, there is no limit to the number of photos that can be taken in a single burst when a shutter speed of 1 s or slower is selected in mode **S** or **M**.



The Memory Buffer

Custom Setting d2 [**Maximum shots per burst**] is used to select the number of shots that can be taken in a single burst. The number of shots that can be taken before the memory buffer fills and shooting slows varies with image quality and other settings. When the buffer is full, the camera will display “**r000**” and the frame advance rate will drop.

d3: Limit Release Mode Selection

MENU button ➔ Custom Settings menu

Choose the release modes that can be accessed by pressing the  button and rotating the main command dial when the release mode dial is rotated to .

- Highlight options and press  or  to select () or deselect (). Modes marked with a check () are available for selection via the main command dial.
- To complete the operation, press MENU.

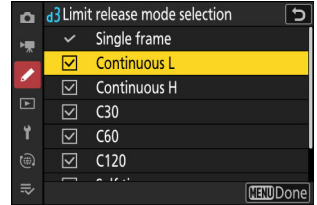

d4: Pre-Release Capture Options

MENU button ➔ Custom Settings menu

Choose the length of the burst recorded from the end of the memory buffer when the shutter-release button is pressed all the way down and the maximum length of the burst recorded while the shutter-release button is fully pressed in high-speed frame capture + mode.

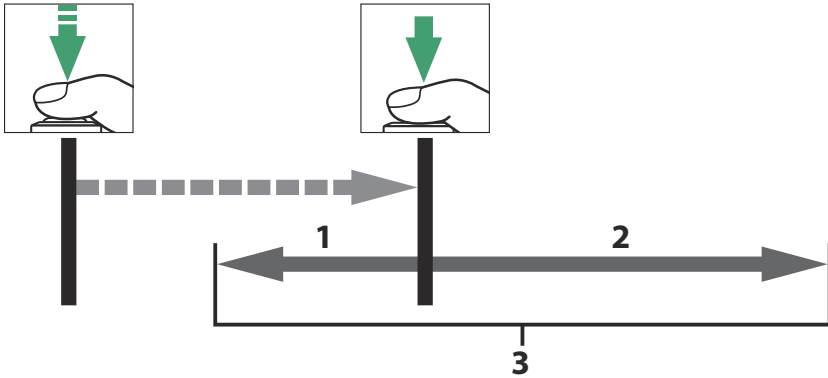

- 1 Portion of buffer recorded to memory card at release (**Pre-release burst**)
- 2 Pictures taken after release (**Post-release burst**)
- 3 Complete high-speed burst

Option	Description
[Pre-release burst]	<p>If an option other than [None] is selected, the camera will buffer frames while the shutter-release button is pressed halfway, but only the frames added to the buffer in the final n seconds, where n is the value selected for [Pre-release burst], will be recorded to the memory card when the shutter-release button is pressed all the way down ("Pre-Release Capture").</p> <ul style="list-style-type: none"> • If the interval between the shutter-release button being pressed halfway and its being pressed all the way down is shorter than the time selected, only the frames saved to the buffer while the button was pressed halfway will be recorded.
[Post-release burst]	<p>Choose the maximum length of time the camera will continue to take pictures after the shutter-release button is pressed all the way down: [1 s], [2 s], [3 s], or [Max.]. Shooting can continue for up to about 4 s when [Max.] is selected.</p>

A  icon appears in the shooting display when an option other than **[None]** is selected for **[Pre-release burst]**. While the shutter-release button is pressed halfway, a green dot (●) will appear in the icon to show that buffering is in progress.

- If the shutter-release button is pressed halfway for more than about 30 seconds,  will appear in the icon and Pre-Release Capture will be cancelled. Pre-Release Capture can be resumed by lifting your finger from the shutter-release button and then pressing it halfway again.

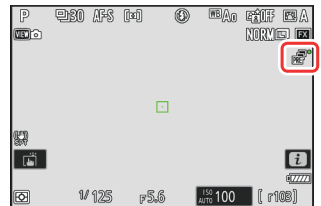

d5: Sync. Release Mode Options

MENU button ➔✎ Custom Settings menu

Choose whether the shutters on the remote cameras are synchronized with the shutter on the master camera when using an optional wireless remote controller or the **[Connect to other cameras]** item in the network menu.

- For information on synchronized release using **[Connect to other cameras]** in the network menu, see the section on “Synchronized Release” ([📖 386](#)) in the “Connecting to Other Cameras” chapter.

d6: Extended Shutter Speeds (M)

MENU button ➔✎ Custom Settings menu

Extend the range of shutter speeds available in mode **M**; the slowest shutter speed available when **[ON]** is selected is 900 s (15 minutes). Extended shutter speeds can be used for pictures of the night sky and other long exposures.

- When **[ON]** is selected, the time remaining in the current exposure will be displayed in the control panel at shutter speeds slower than 30 s.
- At speeds slower than 1 s, the shutter speed displayed by the camera may differ from the actual exposure time. The actual exposure times at shutter speeds of 15 and 30 seconds, for example, are respectively 16 and 32 seconds. The exposure time will again match the selected shutter speed at speeds of 60 seconds and slower.

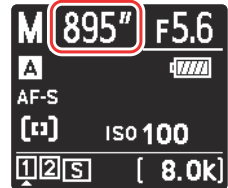

d7: Limit Selectable Image Area

MENU button ➔ Custom Settings menu

Choose the options that can be accessed by rotating a command dial in the **i** menu or while pressing a control to which image area has been assigned.

- Highlight options and press **OK** or **DISP** to select () or deselect (). Modes marked with a check () are available for selection via the command dials.
- To complete the operation, press MENU.

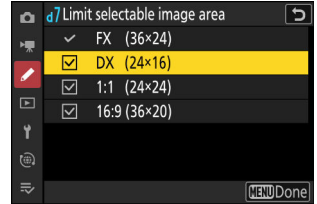

d8: File Number Sequence

MENU button ➡✎ Custom Settings menu

Choose a file numbering option.

Option	Description
[On]	When a new folder is created or a new memory card is inserted in the camera, file numbering will continue from the last number used. This simplifies file management by minimizing the occurrence of duplicate file names when multiple cards are used.
[Off]	When a new folder is created or a new memory card is inserted, file numbering restarts from 0001. If the current folder already contains pictures, file numbering will instead continue from the highest file number in the current folder. If you select [Off] after selecting [On] , the camera will store the current file number. File numbering will resume from the previously-stored value the next time [On] is selected.
[Reset]	Reset the file numbering for [On] . If the current folder is empty, file numbering will restart from 0001 with the next picture taken. If the current folder contains pictures, the next picture taken will be assigned a file number by adding one to the highest file number in the current folder.

✔ **File Number Sequence**

- If a picture is taken when the current folder contains a picture numbered 9999, a new folder will be created and file numbering will restart from 0001.
- When the current folder number reaches 999, the camera will no longer be able to create new folders and the shutter release will be disabled if:
 - the current folder contains 5000 pictures (in addition, video recording will be disabled if the camera calculates that the number of files needed to record a video of the maximum length would result in the folder containing over 5000 files), or
 - the current folder contains a picture numbered 9999 (in addition, video recording will be disabled if the camera calculates that the number of files needed to record a video of the maximum length would result in a file numbered over 9999).

To resume shooting, choose **[Reset]** for Custom Setting d8 **[File number sequence]** and then either format the current memory card or insert a new memory card.



✔ **Folder Numbering**



- If a picture is taken when the current folder contains 5000 pictures or a picture numbered 9999, a new folder will be created and selected as the current folder.
 - The new folder is assigned a number one higher than current folder number. If a folder with that number already exists, the new folder will be assigned the lowest available folder number.
-

d9: View Mode (Photo Lv)

MENU button ➡ Custom Settings menu

Choose whether the camera adjusts the preview in the viewfinder or monitor to reflect how shooting settings will affect the hue and brightness of the final picture. Regardless of the option selected, the effects of camera settings are always visible in video mode.

Option	Description
 [Show effects of settings]	<p>The effects of white balance, Picture Controls, exposure compensation, and other settings that affect color and exposure are visible in the shooting display. Pressing  when [Show effects of settings] is highlighted displays [Always] and [Only when flash is not used] options.</p> <ul style="list-style-type: none">• [Always]: The effects of settings are also visible when a flash unit is attached and ready to fire.<ul style="list-style-type: none">- This setting is recommended when the display is used for adjustments to background exposure.- The main subject may appear dark in the shooting display.- The brightness of the scene shown in the shooting display may differ from that of the actual subject if TTL is selected for flash control mode with [ON] selected for [ISO sensitivity settings] > [Auto ISO sensitivity control] in the photo shooting menu.• [Only when flash is not used]: Display brightness is adjusted for ease of viewing (as per [Adjust for ease of viewing]) when a flash unit is attached and ready to fire. The effects of settings on colors are visible regardless.•  will appear in the shooting display.

Option	Description
<div style="display: flex; align-items: center;"> <div style="margin-right: 10px;">VIEW ></div> <div>[Adjust for ease of viewing]</div> </div>	<p>The effects of changes to settings such as white balance, Picture Controls, and exposure compensation are not visible in the shooting display. Pressing  when [Adjust for ease of viewing] is highlighted displays [Auto] and [Custom] options.</p> <ul style="list-style-type: none"> • [Auto]: Color, brightness, and other settings are adjusted for ease of viewing during prolonged periods of use. • [Custom]: Press  to make individual adjustments to [White balance], [Set Picture Control], and [Brighten shadows]. <ul style="list-style-type: none"> - [White balance]: Choose from [Preview current setting], [Auto], and [Choose color temperature]. Select [Choose color temperature] to choose the color temperature for the shooting display. - [Set Picture Control]: Choose from [Preview current setting] and [Adjust for ease of viewing]. - [Brighten shadows]: Choose whether or by how much the camera brightens shadows (dark areas) in the display; the available options are [Off], [+1], [+2], and [+3]. The higher the value, the greater the effect. •  > will appear in the shooting display.

d10: Starlight View (Photo Lv)



MENU button ➡✎ Custom Settings menu

Select **[ON]** to brighten the display for ease of viewing in dark environments (starlight view). Note that the display may become slightly jerky when starlight view is in effect.

d11: Warm Display Colors

MENU button ➡ Custom Settings menu

Use warmer colors with reduced brightness in the shooting, menu, and/or playback displays. This makes the displays easier to view with vision adapted to dark environments during astronomical photography and the like.

Option	Description
[Warm display color options]	Choose from the following options. <ul style="list-style-type: none">• [Mode 1]: Use warmer colors in the shooting, menu, and playback displays.• [Mode 2]: Use warmer colors in the menu display. Warmer colors are also used for the icons and other information in the shooting and playback displays, but not for the view through the lens or the content of pictures themselves.• [Off]: Warm colors are not used.
[Warm color display brightness]	Press  or  to adjust warm color display brightness. Choose higher values for increased brightness, lower values for reduced brightness.

d12: LCD Illumination

MENU button ➔✎ Custom Settings menu

Choose when the control panel and button backlights light.

- If **[OFF]** is selected, the backlights will light when the power switch is rotated to **⚙**. The backlights turn off when the shutter-release button is pressed.
- If **[ON]** is selected, the backlights will light while the standby timer is active. Note that this increases the drain on the battery. The backlights will turn off while the shutter-release button is pressed, but will turn on again when the button is released.

Tip: Button Backlights

The following are equipped with backlights:

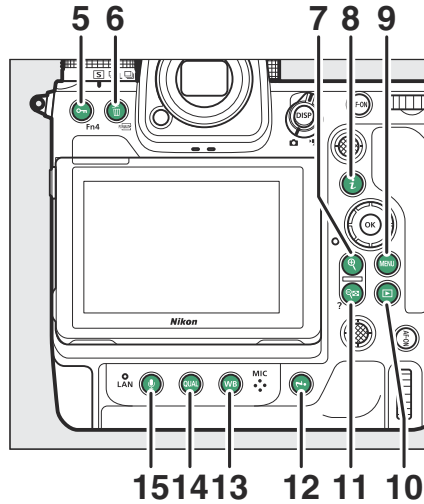
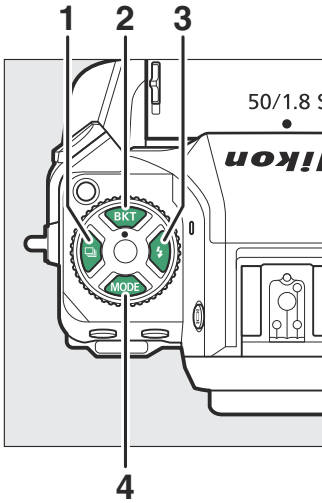

- 1** button
- 2** **BKT** button
- 3** button
- 4** **MODE** button
- 5** (**Fn4**) button
- 6** (**Fn5**) button
- 7** button
- 8** button

- 9** **MENU** button
- 10** button
- 11** (?) button
- 12** button for vertical shooting
- 13** **WB** button
- 14** **QUAL** button
- 15** button

d13: View All in Continuous Mode

MENU button → Custom Settings menu

If **[OFF]** is selected, the display will go blank during burst photography.

d14: Release Timing Indicator

MENU button ➡✎ Custom Settings menu

Adjust settings related to how the display responds when the shutter is released.

Option	Description
[Indicator type]	<ul style="list-style-type: none">• Choose how the display responds when the shutter is released.<ul style="list-style-type: none">- [Type A]: The display goes dark when the shutter is released. This makes it easier to track the subject during panning shots.- [Type B]: Borders appear at the top, bottom, and sides of the frame when the shutter is released.- [Type C]: Borders appear at the sides of the frame when the shutter is released.- [Off]: A release timing indicator is not displayed when the shutter is released.• Note that regardless of the option selected, release timing indicators are not displayed at slow shutter speeds.
[Type A auto restore delay]	<p>Choose the shutter speed at which the camera switches to [Type A] when an option other than [Type A] is selected for [Indicator type].</p> <ul style="list-style-type: none">• This option takes effect in modes S and M.• When pictures are taken at shutter speeds at or below the value chosen for [Type A auto restore delay], the display will go dark to indicate that the shutter has been released.• The [Type A] display makes it easier to track the subject during panning shots.

d15: Image Frame

MENU button ➡ Custom Settings menu

Select **[OFF]** to hide the white border around the shooting displays in the monitor and viewfinder.

d16: Grid Type

MENU button ➔✎ Custom Settings menu

Choose a framing grid for the shooting display. The selected grid can be displayed by placing a check () next to  in the list for Custom Setting d18 [**Custom monitor shooting display**] ([📖 621](#)) or d19 [**Custom viewfinder shooting display**] ([📖 623](#)).

d17: Virtual Horizon Type

MENU button ➔ Custom Settings menu

Choose a virtual horizon for the shooting display. The selected virtual horizon can be displayed by placing a check (☑) next to  in the list for Custom Setting d18 [**Custom monitor shooting display**] ([621](#)) or d19 [**Custom viewfinder shooting display**] ([623](#)).

- **[Type A]:** A large indicator showing roll and pitch fills the display.

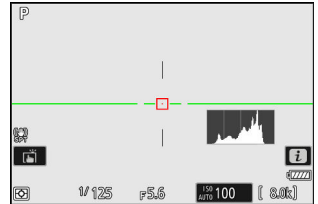

- **[Type B]:** A roll indicator appears at the bottom of the display and a pitch indicator at its right edge.

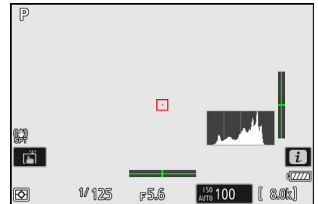



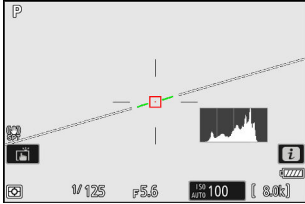
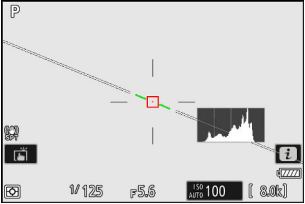
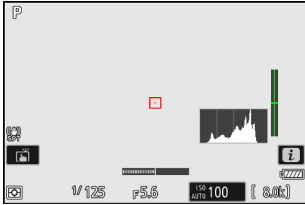
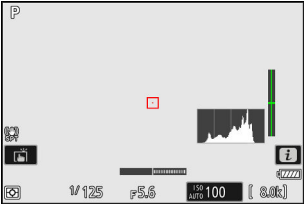

* The indicators are displayed in green when the camera is level.

Roll

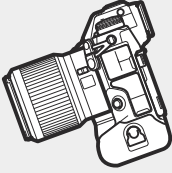
Option	Camera rotated clockwise	Camera rotated counterclockwise
[Type A]		
[Type B]		

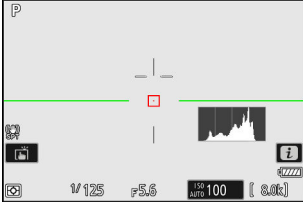
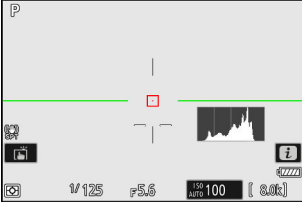
Pitch

	Camera tilted forward	Camera tilted back
Option		
[Type A]		
[Type B]		

The Virtual Horizon Display

Note that the display may not be accurate when the camera is tilted at a sharp angle forward or back. The camera will not display the virtual horizon or pitch and roll indicators when held at angles at which tilt cannot be measured.





d18: Custom Monitor Shooting Display

MENU button ➔ Custom Settings menu

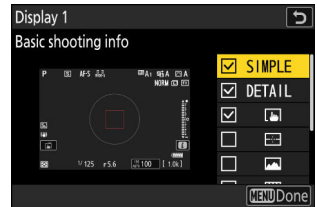
Choose the monitor displays accessible by pressing the **DISP** button during shooting.

- Highlight items ([**Display 2**] through [**Display 5**]) and press \odot to select () or deselect (). Only displays marked with a check () can be accessed by pressing the **DISP** button during shooting. [**Display 1**] cannot be deselected.
- To choose indicators that appear in displays [**Display 1**] through [**Display 4**], highlight the corresponding option and press \odot . You can then highlight items and press \odot to select () or deselect ().



	Option	Description
SIMPLE	[Basic shooting info]	View the shooting mode, shutter speed, aperture, and other basic shooting info.
DETAIL	[Detailed shooting info]	View the focus mode, AF-area mode, white balance, and other detailed shooting info.
	[Touch controls]	View options that can be accessed via touch controls, including touch AF and the \mathbf{z} menu.
	[Virtual horizon]	Enable the virtual horizon. The display type can be selected using Custom Setting d17 [Virtual horizon type].
	[Histogram]	Enable the RGB histogram.
	[Framing grid]	Enable the framing grid. The display type can be selected using Custom Setting d16 [Grid type].
	[Center indicator]	Display crosshairs at the center of the frame.

	Option	Description
	[Center-weighted area]	<p>Add an 8 or 12 mm circle to the center of the shooting display whenever [Center-weighted metering] is selected for [Metering] in the photo shooting menu.</p> <ul style="list-style-type: none"> The size of the circle varies with the option selected for Custom Setting b5 [Center-weighted area]. The circle is not displayed when [Average] is selected for Custom Setting b5 [Center-weighted area].

- **[Display 5]** consists solely of the information display and cannot be customized.
- To complete the operation, press **MENU**.

d19: Custom Viewfinder Shooting Display

MENU button ➔✎ Custom Settings menu

Choose the viewfinder displays accessible by pressing the **DISP** button during shooting.

- Highlight items ([**Display 2**] through [**Display 4**]) and press \odot to select () or deselect (). Only displays marked with a check () can be accessed by pressing the **DISP** button during shooting. [**Display 1**] cannot be deselected.
- To choose indicators that appear in displays [**Display 1**] through [**Display 4**], highlight the corresponding option and press \odot . You can then highlight items and press \odot to select () or deselect (). Apart from [**Touch controls**], the options are the same as those for Custom Setting d18 [**Custom monitor shooting display**] ([621](#)).
- To complete the operation, press MENU.

d20 High FPS Viewfinder Display

MENU button ➔ Custom Settings menu

Select **[ON]** to smooth the display in the viewfinder according to shooting conditions. The movements of fast-moving subjects will be easier to see.

e1: Flash Sync Speed

MENU button ➡ Custom Settings menu

Choose the flash sync speed.

Option	Description
[1/250 s (Auto FP)]	Flash sync speed is set to $1/250$ or $1/200$ s. With compatible flash units, auto FP high-speed sync will automatically be enabled at shutter speeds faster than $1/250$ or $1/200$ s. <ul style="list-style-type: none">• In modes P and A, auto FP high-speed sync will be activated if the actual shutter speed is faster than $1/250$ or $1/200$ s. If the flash supports auto FP high-speed sync, the camera can select shutter speeds as fast as $1/8000$ s.• In modes S and M, the user can select shutter speeds as fast as $1/8000$ s when using flash units that support auto FP high-speed sync.
[1/200 s (Auto FP)]	
[1/200 s]	Flash sync speed set to selected value, which can be from $1/200$ to $1/60$ s.
[1/160 s]	
[1/125 s]	
[1/100 s]	
[1/80 s]	
[1/60 s]	

✓ **Cautions: Auto FP High-Speed Sync**

Depending on the shutter speed, horizontal lines may appear in pictures taken using auto FP high-speed sync when [1/250 s (Auto FP)] or [1/200 s (Auto FP)] is selected. This effect can be mitigated by:

- choosing a slower shutter speed or
 - adjusting flash output.
-

Tip: Auto FP High-Speed Sync

Auto FP high-speed sync allows the flash to be used at shutter speeds as fast as $\frac{1}{8000}$ s. When [1/250 s (Auto FP)] or [1/200 s (Auto FP)] is selected, the camera automatically enables auto FP high-speed sync at shutter speeds faster than the flash sync speed. This makes it possible to choose the maximum aperture for reduced depth of field even when the subject is backlit in bright sunlight.

e2: Flash Shutter Speed

MENU button ➔ Custom Settings menu

Choose the slowest shutter speed available with a flash in mode **P** or **A**.

Regardless of the setting chosen for Custom Setting e2 [**Flash shutter speed**], shutter speeds can be as slow as 30 s in modes **S** and **M** or at flash settings of slow sync, slow rear-curtain sync, or red-eye reduction with slow sync.

e3: Exposure Comp. for Flash

MENU button ➡✎ Custom Settings menu



Choose how the camera adjusts flash level when exposure compensation is used.

Option		Description
<input checked="" type="checkbox"/>	[Entire frame]	The camera adjusts both the flash level and exposure. This changes the exposure for the entire frame.
<input checked="" type="checkbox"/>	[Background only]	Exposure compensation is adjusted for the background only.

e4: Auto ISO Sensitivity Control

MENU button   Custom Settings menu

Choose how the camera adjusts flash level when auto ISO sensitivity control is enabled.

	Option	Description
	[Subject and background]	The camera takes both the main subject and background lighting into account when adjusting ISO sensitivity.
	[Subject only]	ISO sensitivity is adjusted only to ensure that the main subject is correctly exposed.

e5: Modeling Flash





MENU button ➔✎ Custom Settings menu

If **[ON]** is selected when the camera is used with an optional flash unit that supports the Nikon Creative Lighting system, pressing a control to which **[Preview]** has been assigned using Custom Setting f2 **[Custom controls (shooting)]** will emit a modeling flash.

e6: Auto Bracketing (Mode M)

MENU button ➡✎ Custom Settings menu

The settings affected when bracketing is enabled in mode **M** and **[OFF]** is selected for **[ISO sensitivity settings]** > **[Auto ISO sensitivity control]** in the photo shooting menu are determined by the options selected for **[Auto bracketing]** > **[Auto bracketing set]** in the photo shooting menu and the option chosen for Custom Setting e6 **[Auto bracketing (mode M)]**.

Custom Setting e6[Auto bracketing (mode M)]		Photo shooting menu [Auto bracketing] > [Auto bracketing set]	
		AE & flash bracketing	AE bracketing
	[Flash/speed]	Shutter speed and flash level	Shutter speed
	[Flash/speed/aperture]	Shutter speed, aperture, and flash level	Shutter speed and aperture
	[Flash/aperture]	Aperture and flash level	Aperture
ISO	[Flash/ISO sensitivity]	ISO sensitivity and flash level	ISO sensitivity
	[Flash only]	Flash level	—

- When **[ON]** is selected for **[ISO sensitivity settings]** > **[Auto ISO sensitivity control]** in the photo shooting menu, the camera will vary flash level and/or ISO sensitivity as per **[Flash/ISO sensitivity]**, regardless of the option selected for Custom Setting e6 **[Auto bracketing (mode M)]**.



Flash Bracketing

Flash bracketing is performed only with i-TTL or  (auto aperture) flash control.

e7: Bracketing Order

MENU button ➡/✎ Custom Settings menu

Choose the order in which the shots in the bracketing program are taken.



Option		Description
	[MTR > under > over]	The unmodified shot is taken first, followed by the shot with the lowest value, followed by the shot with the highest value.
	[Under > MTR > over]	Shooting proceeds in order from the lowest to the highest value.

- Custom Setting e7 [**Bracketing order**] has no effect on the order of the shots taken when [**ADL bracketing**] is selected for [**Auto bracketing**] > [**Auto bracketing set**] in the photo shooting menu.

e8: Flash Burst Priority



MENU button ➡✎ Custom Settings menu



Choose whether optional flash units emit monitor pre-flashes before each shot during burst photography in high- or low-speed continuous release mode.



























	Option	Description
	[Prioritize frame advance rate]	The flash unit emits a monitor pre-flash before the first shot in each sequence and locks output at the metered value for the remaining shots. The frame advance rate drops less than when [Prioritize precise flash control] is selected. <ul style="list-style-type: none">• An FV lock icon () will appear in the shooting display during burst photography.
	[Prioritize precise flash control]	The flash unit emits a monitor pre-flash before each shot and adjusts flash output as required. The frame advance rate may drop in some circumstances.







f1: Customize Menu

MENU button  Custom Settings menu

Choose the items listed in the  menu displayed when the  button is pressed in photo mode.

- Highlight a position in the  menu, press , and select the desired item.
- The following items can be assigned to the  menu.

	Option	
	[Shooting menu bank]	 439
	[Select custom settings bank]	 570
	[Choose image area]	 104
QUAL	[Image quality]	 106
SIZE	[Image size]	 108
	[View memory card info]	 636
	[Exposure compensation]	 137
ISO	[ISO sensitivity settings]	 147
WB	[White balance]	 151
	[Set Picture Control]	 183
RGB	[Color space]	 458
	[Active D-Lighting]	 459
	[Long exposure NR]	 461
ISO NR	[High ISO NR]	 462
	[Metering]	 470
	[Flash mode]	 409

	Option	
	[Flash compensation]	411
	[Wireless options/flash mode]	414
	[Group flash options]	419 , 427
	[Test flash]	415 , 426
	[Flash info]	419
	[Radio remote flash info]	415
	[Focus mode]	110
	[AF-area mode/subj. detection]	112
	[Vibration reduction]	477
	[Auto bracketing]	478
	[Multiple exposure]	479
	[HDR overlay]	487
	[Interval timer shooting]	492
	[Time-lapse video]	503
	[Focus shift shooting]	514
	[Focus tracking with lock-on]	573
	[Silent mode]	758
	[Pre-Release Capture options]	601
	[Custom controls (shooting)]	637
	[View mode (photo Lv)]	608
	[Split-screen display zoom]	636

Option		📖
PEAK	[Focus peaking]	📖 585
☀️	[Monitor/viewfinder brightness]	📖 728 , 📖 730
✈️	[Airplane mode]	📖 781
RED	[Warm display colors]	📖 611

View Memory Card Info

View the slot currently selected as the destination for new pictures and the options used to record pictures when two memory cards are inserted. This option can be used to view but not to change the option selected.

- The options used to record pictures when two memory cards are inserted can be selected using **[Role played by card in Slot 2]** in the photo shooting menu.

Split-Screen Display Zoom

If **[Split-screen display zoom]** is assigned to the **z** menu, you can select **[Split-screen display zoom]** to simultaneously zoom in on two areas that are aligned horizontally but are in different parts of the frame (split-screen display zoom). The locations of the areas are indicated by the two frames (□) in the navigation window in the bottom right corner of the display.

- Zooming in simultaneously on two widely-separated but horizontally-aligned areas of the frame makes it easier to level pictures of buildings or other wide objects.
- Use the **Q** and **Q?** (?) buttons to zoom in and out.
- Press **←** or **→** to scroll the selected area left or right. Use the **↻** button to switch between the two areas.
- Press **↑** or **↓** to scroll both areas up or down simultaneously.
- To focus on the subject at the center of the selected area, press the shutter-release button halfway.
- To exit split-screen display zoom, press the **z** button.

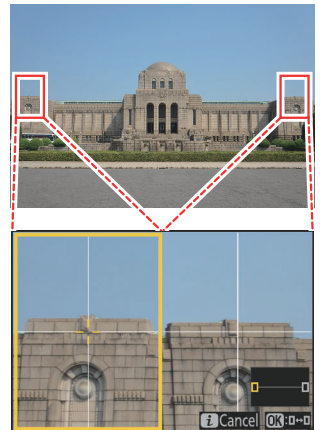

f2: Custom Controls (Shooting)







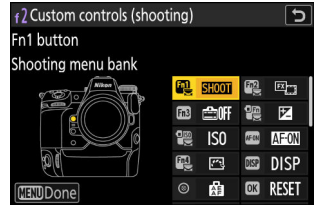



MENU button ➔ Custom Settings menu

Choose the operations performed in photo mode using camera or lens controls, including the camera buttons and sub-selector and the lens control ring.

- Choose the roles played by the controls below. Highlight the desired control and press **OK**.





















Option	
	[Fn1 button]
	[Fn2 button]
	[Fn3 button]
	[Fn button for vertical shooting]
	[Vertical ISO sensitivity button]
	[AF-ON button]
	[Protect/Fn4 button]
	[DISP button]
	[Sub-selector center]
	[OK button]
	[Audio button]
	[QUAL button]
	[Vertical multi selector center]













Option	
	[AF-ON button for vertical shooting]
	[Video record button]
	[Exposure compensation button]
	[ISO sensitivity button]
	[Command dials]
	[Lens Fn button]
	[Lens Fn2 button]
	[Lens Fn ring (counterclockwise)]
	[Lens Fn ring (clockwise)]
	[Lens memory set button]
	[Lens control ring]



- The roles that can be assigned are listed below. The roles available vary with the control.











Role	Description
PRE ⁰⁴ [Preset focus point]	<p>Pressing the control selects a preset focus point.</p> <ul style="list-style-type: none"> • To choose the point, highlight it, hold the control, and press the focus-mode button until the focus point flashes. • Separate focus points can be selected for “wide” (landscape) orientation and for each of the two “tall” (portrait) orientations if an option other than [Off] is selected for Custom Setting a5 [Store points by orientation]. • The behavior of the selected control can be chosen by pressing  when [Preset focus point] is highlighted. <ul style="list-style-type: none"> - [Press to recall focus point]: Pressing the control recalls the preset focus point. - [Hold to recall focus point]: The preset focus point is selected while the control is pressed. Releasing the control restores the focus point selected before the control was pressed.















	Role	Description
	[Select center focus point]	Pressing the control selects the center focus point.
	[Save focus position]	<p>Holding the control saves the current focus position.</p> <ul style="list-style-type: none"> • The saved position can be restored using a control to which [Recall focus position] has been assigned (“memory recall”). • When saving the focus position, you can choose whether it can be recalled using any of the controls to which [Recall focus position] is assigned ([Save to all]) or using only a specific control ([Save individually]). • For more information, see “Saving and Recalling Focus Positions” (649).
	[Recall focus position]	<p>Pressing the control recalls a focus position saved using a control to which [Save focus position] has been assigned.</p> <ul style="list-style-type: none"> • For more information, see “Saving and Recalling Focus Positions” (649).
	[AF-area mode]	<p>Holding the control selects a preset AF-area mode. The AF-area mode previously in effect is restored when the control is released.</p> <ul style="list-style-type: none"> • To choose the AF-area mode, press  when [AF-area mode] is highlighted.
	[AF-area mode + AF-ON]	<p>Holding the control selects a preset AF-area mode and initiates autofocus. The AF-area mode previously in effect is restored when the control is released.</p> <ul style="list-style-type: none"> • To choose the AF-area mode, press  when [AF-area mode + AF-ON] is highlighted.
	[AF-ON]	Pressing the control initiates autofocus, duplicating the function of the AF-ON button.
	[AF lock only]	Focus locks while the control is pressed.
	[AE lock (Hold)]	Exposure locks when the control is pressed. Exposure lock does not end when the shutter is released. Exposure remains locked until the control is pressed a second time or the standby timer expires.









	Role	Description
	[AWB lock (hold)]	If [Auto] or [Natural light auto] is selected for white balance, white balance will lock when the control is pressed (white-balance lock). White-balance lock does not end when the shutter is released. The lock will however be released when the control is pressed a second time or the standby timer expires.
	[AE/AWB lock (hold)]	Exposure locks when the control is pressed. White balance will also lock provided [Auto] or [Natural light auto] is selected for white balance. Exposure and white-balance lock do not end when the shutter is released. The lock will however be released when the control is pressed a second time or the standby timer expires.
	[AE lock (Reset on release)]	Exposure locks when the control is pressed. Exposure remains locked until the control is pressed a second time, the shutter is released, or the standby timer expires.
	[AE lock only]	Exposure locks while the control is pressed.
	[AE/AF lock]	Focus and exposure lock while the control is pressed.
	[FV lock]	Press the control to lock flash value for optional flash units; press again to cancel FV lock.
	[⚡ Disable/enable]	If the flash is currently enabled, it will be disabled while the control is pressed. If the flash is currently off, front-curtain sync will be selected while the control is pressed.
	[Switch FX/DX]	Press the control to switch to [DX (24×16)] when [FX (36×24)] is chosen for image area. Pressing the control when an option other than [FX (36×24)] is chosen for image area selects [FX (36×24)] .
FLICKER	[Photo flicker reduction]	Press the control to select [ON] for [Photo flicker reduction] in the photo shooting menu. Press again to select [OFF] .
	[Preview]	While the control is pressed, the shooting display will show how color, exposure, and depth of field are affected by current photo settings.







Role	Description
 [Recall shooting functions]	<p>Hold the control to recall previously-selected settings.</p> <ul style="list-style-type: none"> • To choose the settings recalled, press  when [Recall shooting functions] is highlighted. <ul style="list-style-type: none"> - Highlight items using  or  and press  to select (<input checked="" type="checkbox"/>) or deselect (<input type="checkbox"/>). Only items marked with a check (<input checked="" type="checkbox"/>) will be recalled while the button is pressed. - Highlight items using  or  and press  to view options. Press  to save changes and exit. - To store current camera settings for later recall using this option, select [Save current settings]. • Settings such as shutter speed and aperture can be changed by holding the control and rotating a command dial. <ul style="list-style-type: none"> - In mode P, you can adjust flexible program settings. - If an option other than [Off] is selected for Custom Setting b3 [Easy exposure compensation], exposure compensation can be adjusted by rotating a command dial.
 [Recall shooting functions (hold)]	<p>Press the control to recall previously-stored settings for still photography (including shooting mode and metering). Pressing the control a second time restores the settings in effect before stored settings were recalled.</p> <ul style="list-style-type: none"> • To choose the settings recalled, press  when [Recall shooting functions (hold)] is highlighted. The settings that can be stored are the same as for [Recall shooting functions]. [Recall shooting functions (hold)] cannot, however, be used to save or recall settings for [AF-ON]. • A  icon will appear in the shooting display while stored settings are in effect. • Shutter speed and aperture can be changed by rotating the command dials while stored settings are in effect. <ul style="list-style-type: none"> - In mode P, you can adjust flexible program settings. - If an option other than [Off] is selected for Custom Setting b3 [Easy exposure compensation], exposure compensation can be adjusted by rotating a command dial.
 [High-frequency flicker reduction]	<p>Pressing the control allows shutter speed to be fine-tuned in smaller increments. Press the control a second time to restore normal shutter-speed selection.</p>

Role	Description
 [Bracketing burst]	<ul style="list-style-type: none"> • If the control is pressed when an option other than [WB bracketing] is selected for [Auto bracketing] > [Auto bracketing set] in the photo shooting menu in continuous release mode, the camera will take all the shots in the current bracketing program and repeat the bracketing burst while the shutter-release button is pressed. In single-frame release mode, shooting will end after the first bracketing burst. • If [WB bracketing] is selected for [Auto bracketing set], the camera will take pictures while the shutter-release button is pressed and apply white balance bracketing to each shot.
 [Sync. release selection]	<p>When [Synchronized release] is selected for [Connect to other cameras] in the network menu, or when a wireless remote controller is used for synchronized release, the chosen control can be used to toggle between remote release and master or synchronized release. The options available depend on the setting chosen for Custom Setting d5 [Sync. release mode options].</p> <ul style="list-style-type: none"> • The following options are available when [Sync] is selected for [Sync. release mode options]: <ul style="list-style-type: none"> - [Master release only] (☑️): Keep the control pressed to take pictures with the master camera only. - [Remote release only] (☑️): Keep the control pressed to take pictures only with the remote cameras. • The following options are available when [No sync] is selected for [Sync. release mode options]: <ul style="list-style-type: none"> - [Synchronized release] (☑️): Keep the control pressed to synchronize the releases on the master and remote cameras. - [Remote release only] (☑️): Keep the control pressed to take pictures only with the remote cameras.
 [Override other cameras]	<p>Press the control to remotely take over the master camera role from another camera functioning as a master camera commanding remote cameras during synchronized release.</p> <ul style="list-style-type: none"> • This option takes effect when multiple cameras in the same group have been designated as masters using [Connect to other cameras] in the network menu. • It cannot be used to promote cameras functioning in the remote role to the role of master camera.

Role		Description
 [+ RAW]	[+ RAW]	<ul style="list-style-type: none"> If a JPEG option is currently selected for image quality, "RAW" will appear in the shooting display and an NEF (RAW) copy will be recorded with the next picture taken after the control is pressed. The original image quality setting will be restored when you remove your finger from the shutter-release button or press the control again, canceling [+ RAW]. NEF (RAW) copies are recorded at the settings currently selected for [RAW recording] in the photo shooting menu.
	[Silent mode]	Press the control to enable silent mode. Press again to disable.
DISP	[Cycle live view info display]	Press the control to cycle the shooting display. The type and content of the displays available can be chosen using Custom Settings d18 [Custom monitor shooting display] and d19 [Custom viewfinder shooting display].
	[Live view info display off]	Press the control to hide icons and other information in the shooting display. Press again to view.
	[Framing grid]	Press the control to display a framing grid. To hide the grid, press the control again. The display type can be selected using Custom Setting d16 [Grid type].
	[Zoom on/off]	Press the control to zoom the display in on the area around the current focus point. Press again to cancel zoom.
	[Virtual horizon]	Press the control to enable the virtual horizon display. Press again to hide the display. The display type can be selected using Custom Setting d17 [Virtual horizon type].
	[Starlight view (photo Lv)]	Press the control to toggle starlight view on. Press again to end starlight view.
	[View mode (photo Lv)]	Press the control to switch the option selected for Custom Setting d9 [View mode (photo Lv)] from [Show effects of settings] to [Adjust for ease of viewing] or vice versa.
	[Focus peaking display]	Press the control once to enable focus peaking when MF is selected for focus mode. Press again to end focus peaking.
	[MY MENU]	Press the control to display "MY MENU".

	Role	Description
	[Access top item in MY MENU]	Press the control to jump to the top item in "MY MENU". Select this option for quick access to a frequently-used menu item.
	[Playback]	Press the control to start playback.
	[Filtered playback]	Press the control to view only pictures that meet the criteria selected for [Filtered playback criteria] in the playback menu.
	[Filtered playback (select criteria)]	Press the control to jump to [Filtered playback criteria] in the playback menu.
	[Same as AF-ON button]	The control plays the role currently selected for the AF-ON button.
	[Same as exp. comp. button]	The control plays the role currently selected for the  button.
	[Same as ISO sensitivity button]	The control plays the role currently selected for the ISO () button.
	[Shooting menu bank]	Press the control and rotate a command dial to choose a shooting menu bank.
	[Shooting mode]	Press the control and rotate the main command dial to choose a shooting mode.
	[Choose image area]	Press the control and rotate a command dial to choose the image area.
QUAL	[Image quality/size]	Press the control and rotate the main command dial to choose an image quality option and the sub-command dial to select image size.
WB	[White balance]	To choose a white balance option, hold the control and rotate the main command dial. Some options offer sub-options that can be selected by rotating the sub-command dial.
	[Set Picture Control]	Press the control and rotate a command dial to choose a Picture Control.
	[Active D-Lighting]	Press the control and rotate a command dial to adjust Active D-Lighting.





	Role	Description
	[Metering]	Press the control and rotate a command dial to choose a metering option.
	[Flash mode/compensation]	Press the control and rotate the main command dial to choose a flash mode and the sub-command dial to adjust flash output.
	[Release mode]	Hold the control and rotate the main command dial to choose a release mode. Options for the selected mode, if any, can be chosen by holding the control and rotating the sub-command dial.
AF/[-]	[Focus mode/AF-area mode]	Hold the control and rotate the main command dial to choose the focus mode, the sub-command dial to choose the AF-area mode.
BKT	[Auto bracketing]	Press the control and rotate the main command dial to choose the number of shots and the sub-command dial to select the bracketing increment or Active D-Lighting amount.
	[Multiple exposure]	Press the control and rotate the main command dial to choose the mode and the sub-command dial to choose the number of shots.
HDR	[HDR overlay]	Press the control and rotate the main command dial to choose the mode and the sub-command dial to adjust HDR strength.
LOCK	[Control lock]	<ul style="list-style-type: none"> • Press the control and rotate the main command dial to lock shutter speed (modes S and M). To lock aperture (modes A and M), press the control and rotate the sub-command dial. • To lock focus-point selection, hold the control and press , , or .
	[1 step spd/aperture]	<p>Make adjustments to shutter speed and aperture in increments of 1 EV, regardless of the option selected for Custom Setting b2 [EV steps for exposure cntrl].</p> <ul style="list-style-type: none"> • In modes S and M, shutter speed can be adjusted in increments of 1 EV by holding the control and rotating the main command dial. • In modes A and M, aperture can be adjusted in increments of 1 EV by holding the control and rotating the sub-command dial.

	Role	Description
Non-CPU	[Choose non-CPU lens number]	Press the control and rotate a command dial to choose a lens number saved using the [Non-CPU lens data] item in the setup menu.
M/A	[Focus (M/A)]	Autofocus can be over-riden by rotating the lens control ring (autofocus with manual override). The control ring can be used for manual focus while the shutter-release button is pressed halfway. To refocus using autofocus, lift your finger from the shutter-release button and then press it halfway again.
	[Aperture]	Rotate the lens control ring to adjust aperture.
	[Aperture (open)]	Rotate the lens Fn ring counterclockwise to widen the lens aperture. This option is enabled automatically when [Aperture (close)] is selected for [Lens Fn ring (clockwise)].
	[Aperture (close)]	Rotate the lens Fn ring clockwise to narrow the lens aperture. This option is enabled automatically when [Aperture (open)] is selected for [Lens Fn ring (counterclockwise)].
	[Exposure compensation]	<ul style="list-style-type: none"> Assigning this function to the Fn button for vertical shooting allows exposure compensation to be adjusted by holding the button and rotating a command dial. Assigning this function to the lens control ring allows exposure compensation to be adjusted by rotating the ring.
	[Exposure compensation +]	Rotate the lens Fn ring clockwise for increased exposure compensation. This option is enabled automatically when [Exposure compensation -] is selected for [Lens Fn ring (counterclockwise)].
	[Exposure compensation -]	Rotate the lens Fn ring counterclockwise to reduce exposure compensation. This option is enabled automatically when [Exposure compensation +] is selected for [Lens Fn ring (clockwise)].
ISO	[ISO sensitivity]	Rotate the lens control ring to adjust ISO sensitivity.
	[ISO sensitivity (increase)]	Rotate the lens Fn ring clockwise to increase ISO sensitivity. This option is enabled automatically when [ISO sensitivity (decrease)] is selected for [Lens Fn ring (counterclockwise)].

Role		Description
	[ISO sensitivity (decrease)]	Rotate the lens Fn ring counterclockwise to decrease ISO sensitivity. This option is enabled automatically when [ISO sensitivity (increase)] is selected for [Lens Fn ring (clockwise)] .
[None]		The control has no effect.

Command Dials

The following roles can be assigned to the command dials. To view options, highlight items and press .

Role	Description
[Exposure setting]	Reverse the roles of the main and sub-command dials in selected modes. Press  or  to highlight a mode and  or  to switch roles.
[Focus/AF-area mode selection]	Switch the roles played by rotating the main and sub-command dials while the focus-mode button is pressed.
[Sub-command dial zoom role]	Choose the role played by the sub-command dial in the zoom display. <ul style="list-style-type: none">• Choose [Exposure setting] to change the role played by the sub-command dial in each mode.• Choose [Zoom] to use the sub-command dial to zoom in or out.

Saving and Recalling Focus Positions

You can save the current focus position by pressing and holding a custom control to which you have assigned **[Save focus position]**. The saved focus position can be instantly restored by pressing a custom control assigned **[Recall focus position]** ("memory recall"). You may find this useful if you frequently return to subjects at a fixed focus distance.

- **[Recall focus position]** can be assigned to multiple controls. Focus positions saved by selecting **[Save to all]** for **[Save focus position]** can be recalled using any of the assigned controls. Those saved by selecting **[Save individually]** for **[Save focus position]** can instead be recalled only via a specific control.
- Focus positions can be saved in any focus mode.
- The stored distance is however reset when the lens is detached.

Cautions: Saving and Recalling Focus Positions

- Focus positions cannot be saved while shooting information is displayed.
 - The focus position selected when a stored value is recalled may differ from the saved position due to changes in ambient temperature.
 - Changes to zoom after a focus position is saved tend to alter the position selected when the value is recalled.
-

“Save to All”

1 Assign [Recall focus position] to a control.

Repeat this step for each of the controls you intend to use for memory recall.

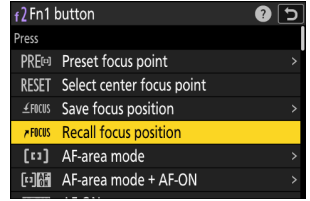

2 Select another control in the custom control list and, when prompted to choose a role, highlight [Save focus position] and press \odot .

Save options will be displayed.

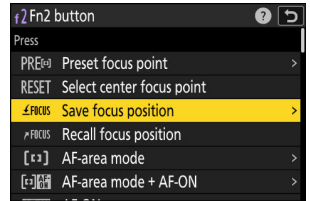

3 Highlight [Save to all] and press \odot .

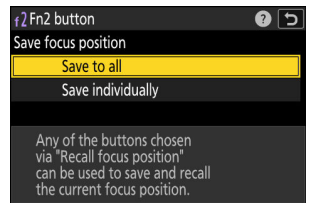

4 Focus on the desired subject in the shooting display and press and hold the control to which [Save focus position] is assigned.

A \odot FOCUS icon will appear in the shooting display if the operation is successful.

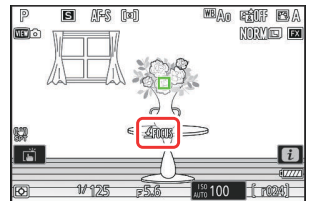

5 Press any of the controls to which [Recall focus position] was assigned in Step 1.

- The saved focus position will be restored.
- Although [Recall focus position] can be assigned to multiple controls, the same focus position will be restored regardless of the control used.
- Holding a control to which [Recall focus position] is assigned activates manual focus (MF), and the camera will not refocus if the shutter-release button is pressed halfway while the control is pressed.

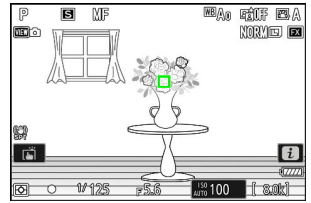

“Save Individually”

1 Assign [Recall focus position] to multiple controls.

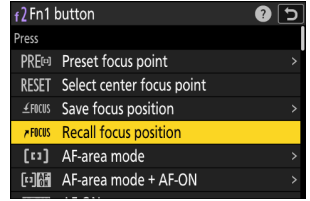

2 Select another control in the custom control list and, when prompted to choose a role, highlight [Save focus position] and press \odot .

Save options will be displayed.

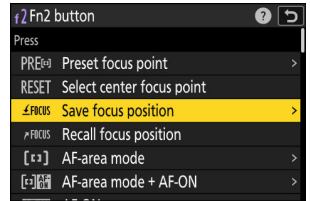

3 Highlight [Save individually] and press \odot .

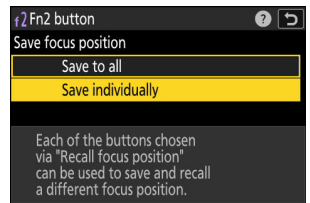

4 Focus on the desired subject in the shooting display and press and hold the control to which [Save focus position] is assigned.

A \odot FOCUS icon will flash in the shooting display.

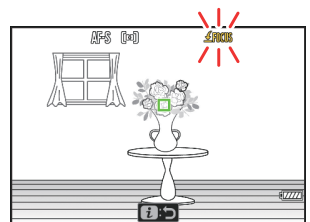

5 Press the button you intend to use for recall of the focus position saved in Step 4.

- Of the controls to which **[Recall focus position]** was assigned in Step 1, press the control you intend to use for recall of the focus position saved in Step 4.
- A message will appear in the shooting display if the operation is successful.
- Repeat Steps 4 to 5 to save additional focus positions to the other controls to which **[Recall focus position]** is assigned.

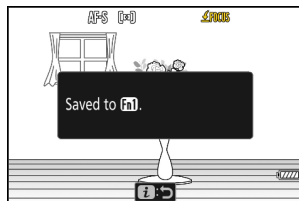

6 Press the control for the desired focus position.

- The focus position saved to the control in question will be restored.
- Holding a control to which **[Recall focus position]** is assigned activates manual focus (**MF**), and the camera will not refocus if the shutter-release button is pressed halfway while the control is pressed.

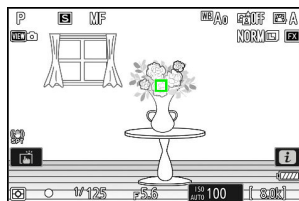

f3: Custom Controls (Playback)

MENU button ➔ Custom Settings menu







Choose the operations performed during playback using the cameras controls listed below.













- Choose the roles played by the controls below. Highlight the desired control and press **OK**.



Option	
	[Fn1 button]
	[Fn2 button]
	[Fn3 button]
	[Fn button for vertical shooting]
	[Protect/Fn4 button]
	[DISP button]
	[Audio button]
	[OK button]
	[WB button]
	[QUAL button]
	[Main command dial]
	[Vertical shooting multi selector]
	[Video record button]
	[Sub-command dial]

- The roles that can be assigned to these controls are listed below. The roles available vary with the control.

Role		Description
	[Protect]	Press the control to toggle protection for the current picture on or off.
	[Zoom on/off]	Press the control to zoom the display in on the area around the current focus point (the zoom ratio is selected in advance). Press again to cancel zoom. <ul style="list-style-type: none"> • To choose the zoom ratio, highlight [Zoom on/off] and press . • Zoom on/off is available in both full-frame and thumbnail playback.
	[Filtered playback]	Press the control to view only pictures that meet the criteria selected for [Filtered playback criteria] in the playback menu.
	[Filtered playback (select criteria)]	Press the control to jump to [Filtered playback criteria] in the playback menu.
	[Start series playback]	Pressing the control when a picture from a burst is displayed full frame starts automated playback (710). The pictures will play back while the control is pressed, at a speed higher than when the multi selector is used. Playback stops when the control is released or the last picture in the burst is displayed.
	[Voice memo]	Use the control for voice memo operations.

Role		Description
	[Select for upload to computer]	<p>Press the control to upload the current picture to a computer or FTP server with which the camera is currently connected.</p> <ul style="list-style-type: none"> To view upload options, highlight [Select for upload to computer] or [Select for upload (FTP)] and press . Highlight options and press  to select (<input checked="" type="checkbox"/>) or deselect (<input type="checkbox"/>). - [Priority upload]: If this option is selected (<input checked="" type="checkbox"/>), pressing the control to mark a picture for upload will move it to the front of the upload queue. - [Protect]: If this option is selected (<input checked="" type="checkbox"/>), pressing the control to mark a picture for upload will simultaneously protect it. - [Rating]: If this option is selected (<input checked="" type="checkbox"/>), pressing the control to mark a picture for upload will simultaneously assign it a preset rating. Press  to choose the rating.
	[Select for upload (FTP)]	
	[Rating]	<p>To rate the current picture in playback mode, press the control and rotate the main command dial.</p> <ul style="list-style-type: none"> To display rating options, highlight [Rating] and press . If an option other than [None] is selected, the chosen rating can be assigned to pictures simply by pressing the selected control. Pressing the control again selects a “no star” rating.
	[Thumbnail on/off]	Press the control to toggle between full-frame and 4-, 9-, or 72-frame thumbnail playback.
	[View histograms]	A histogram is displayed while the control is pressed. The histogram display is available in both full-frame and thumbnail playback.
	[Choose slot and folder]	Press the control to display the [Choose slot and folder] dialog, where you can then choose a slot and folder for playback.
DISP	[Cycle info display]	Press the control to cycle the photo information display during full-frame playback. The pages available can be chosen using [Playback display options] in the playback menu.
	[Resume shooting]	Press the control to end playback and return to shooting mode.
[ /switched]		Press the multi selector for vertical shooting up or down to view other pictures, left or right to page through photo information.







Role	Description
[⏪/⏩ unswitched]	Press the multi selector for vertical shooting up or down to page through photo information, left or right to view other pictures.
[None]	The control has no effect.

Command Dials

The following roles can be assigned to the command dials. To view options, highlight items and press .

Frame Advance

Choose the number of frames that can be skipped by rotating the command dials during full-frame playback.

Option	Description
[1 frame]	Skip forward or back 1 frame at a time.
[10 frames]	Skip forward or back 10 frames at a time.
[50 frames]	Skip forward or back 50 frames at a time.
★ [Rating]	Skip to the next or previous picture with the selected rating.
 [Protect]	Skip to the next or previous protected picture.
 [Photos only]	Skip to the next or previous photo.
 [Videos only]	Skip to the next or previous video.
 [Skip to first shot in series]	Select this option to skip all but the first shot in each burst displayed when scrolling through pictures with the command dials. Pictures that are not part of a burst will not be skipped.
 [Folder]	Rotate the dial to select a folder.
 [Page]	View the next or previous page of thumbnails.

Video Playback



Choose the roles played by the command dials during video playback.

Option	Description
[1 frame]	Advance or rewind a frame at a time.
[5 frames]	Advance or rewind 5 frames at a time.
[10 frames]	Advance or rewind 10 frames at a time.
[2 s]	Skip forward or back 2 s at a time.
[5 s]	Skip forward or back 5 s at a time.
[10 s]	Skip forward or back 10 s at a time.
[First/last frame]	Skip to the first or last frame.

f4: Control Lock

MENU button ➡✎ Custom Settings menu

Lock exposure settings or focus-point selection.

Option	Description
[Shutter speed lock]	Select [ON] to lock shutter speed at its current value in modes S and M . <ul style="list-style-type: none">•  icons appear in the shooting display and control panel when shutter-speed lock is in effect.
[Aperture lock]	Select [ON] to lock aperture at its current value in modes A and M . <ul style="list-style-type: none">•  icons appear in the shooting display and control panel when aperture lock is in effect.
[Focus-point lock]	Select [ON] to lock focus-point selection on the currently-selected focus point. <ul style="list-style-type: none">• Focus point lock does not apply when [Auto-area AF] is selected for AF-area mode.• When [3D-tracking] is selected, the focus point will track subject motion while the shutter-release button is pressed halfway.

f5: Reverse Dial Rotation

MENU button ➔✎ Custom Settings menu





Reverse the direction of rotation of the command dials for selected operations.

- Highlight [**Exposure compensation**] or [**Shutter speed/aperture**] and press  to select () or deselect (.
- Press **MENU** to save changes and exit.
- The changes also apply to the command dial for vertical shooting.

f6: Release Button to Use Dial

MENU button ➡✎ Custom Settings menu



Selecting **[ON]** allows adjustments that are normally made by holding a button and rotating a command dial to be made by rotating the command dial after the button is released. This ends when the button is pressed again, the shutter-release button is pressed halfway, or the standby timer expires.

- **[Release button to use dial]** applies to the  **ISO** () **BKT**, , **MODE**, , **Fn4**, **QUAL**, **WB**, and focus-mode buttons.
- **[Release button to use dial]** also applies to controls to which certain roles have been assigned using Custom Setting f2 [**Custom controls (shooting)**] or g2 [**Custom controls**].

f7: Reverse Indicators

MENU button ➡ Custom Settings menu

Choose whether the exposure indicator is displayed with negative values on the left and positive values on the right, or with positive values on the left and negative values on the right.

Option		Description
+0-		The indicator is displayed with positive values on the left and negative values on the right.
-0+		The indicator is displayed with negative values on the left and positive values on the right.

f8: Reverse Ring for Focus

MENU button ➔✎ Custom Settings menu

Select [**ON**] to reverse the direction of rotation for the focus or control rings on Z mount lenses during manual focus.

- This option does not support:
 - certain Z mount lenses that can only be focused manually, or
 - F mount lenses connected via an FTZ II/FTZ mount adapter.

f9: Focus Ring Rotation Range

MENU button ➔✎ Custom Settings menu

Choose how far the focus or control rings on Z mount lenses must be rotated to go all the way from the minimum focus distance to infinity.

Option	Description
[Non-linear]	The focus distance changes by a large amount when the ring is rotated rapidly and by a small amount when the ring is rotated slowly, without regard to how far the ring is rotated.
[90°]	Choose how far the ring must be rotated to go all the way from the minimum focus distance to infinity. To take focus from the minimum distance to infinity when, for example, [90°] is selected, the ring need only be rotated 90°. Larger values permit finer adjustments.
[120°]	
[150°]	
[180°]	
[210°]	
[240°]	
[270°]	
[300°]	
[330°]	
[360°]	
[540°]	
[720°]	
[Max.]	

- If the lens does not support rotation range selection, [Focus ring rotation range] will be fixed at [Non-linear].

f10: Control Ring Response

MENU button ➔ Custom Settings menu

Choose how responsive the lens control ring is when assigned the following roles using Custom Setting f2 [**Custom controls (shooting)**] or g2 [**Custom controls**].

- Roles assigned using Custom Setting f2 [**Custom controls (shooting)**] or g2 [**Custom controls**]: [**Aperture**], [**Power aperture**], [**Exposure compensation**], [**ISO sensitivity**]
- Roles assigned using Custom Setting g2 [**Custom controls**]: [**Hi-Res Zoom**]

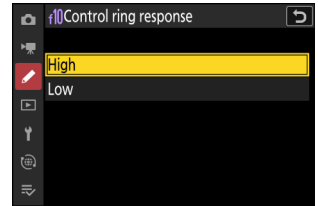

f11: Switch Focus/Control Ring Roles

MENU button ➔✎ Custom Settings menu

If **[ON]** is selected, the focus ring will perform the role currently assigned to the control ring using Custom Setting f2 [**Custom controls (shooting)**] or g2 [**Custom controls**].

- When **[ON]** is selected, the control ring functions solely in the **[Focus (M/A)]** role.
- This option applies only to compatible lenses.

f12: Full-Frame Playback Flicks

MENU button ➔✎ Custom Settings menu

Choose the role assigned to the flick up and down or flick left and right gestures during full-frame playback.

Flick Up/Flick Down

Choose the operation performed by flicking up or down.

Option		Description
★	[Rating]	Assign the current picture a pre-selected rating. The rating can be chosen by pressing Ⓢ.
↔PC	[Select for upload to computer]	Mark the current picture for priority upload to a computer.
↔FTP	[Select for upload (FTP)]	Mark the current picture for priority upload to an FTP server.
🔒	[Protect]	Protect the current picture.
🗣️	[Voice memo]	Flick to start recording a voice memo. If a memo already exists for the current picture, flicking instead begins playback of the existing memo. Press Ⓢ to end recording or playback.
[None]		Flicking up or down has no effect.

- Pictures selected by flicking up or down when [Rating], [Select for upload to computer], [Select for upload (FTP)], or [Protect] is selected are indicated by icons ([🔗 229](#)). The marking can be removed by flicking again in the same direction.

Flick Advance Direction

Choose the gesture used for frame advance.

Option		Description
←	[Left←Right]	Flick from right to left to view the next picture.
→	[Left→Right]	Flick from left to right to view the next picture.

f13: Prefer Sub-selector Center

MENU button ➡/✎ Custom Settings menu

Choose how the sub-selector behaves while its center is pressed.

Option	Description
[ON]	The sub-selector cannot be used to position the focus point while the center is pressed.
[OFF]	The sub-selector can be used to position the focus point while the center is pressed.















The center of the sub-selector, meanwhile, functions in the role chosen for **[Sub-selector center]** using Custom Setting f2 **[Custom controls (shooting)]** or g2 **[Custom controls]**. This is particularly noteworthy in that if you assign **[AF-area mode]** to the center of the sub-selector via Custom Setting f2 **[Custom controls (shooting)]**, you will then be able to use it to temporarily switch AF-area modes without interfering with your ability to position the focus point.

















g1: Customize Menu

MENU button  Custom Settings menu



Choose the items listed in the **i** menu displayed when the **i** button is pressed in video mode.

- Highlight a position in the **i** menu, press , and select the desired item.
- The following items can be assigned to the **i** menu.



	Option	
	[Shooting menu bank]	439
	[Select custom settings bank]	570
	[Choose image area]	212
	[Frame size/frame rate]	205
	[Destination]	528
	[Exposure compensation]	137
ISO	[ISO sensitivity settings]	147
WB	[White balance]	151
	[Set Picture Control]	183
HLG 	[HLG quality]	538
	[Active D-Lighting]	459
	[Metering]	470
AF/MF	[Focus mode]	110
	[AF-area mode/subj. detection]	112
	[Vibration reduction]	550
	[Electronic VR]	551

	Option	
	[Microphone sensitivity]	📖 552
	[Attenuator]	📖 553
	[Frequency response]	📖 554
	[Wind noise reduction]	📖 555
	[Headphone volume]	📖 557
	[Hi-Res Zoom]	📖 223
	[Silent mode]	📖 758
	[Custom controls]	📖 674
	[Focus peaking]	📖 585
	[Zebra pattern]	📖 692
	[Monitor/viewfinder brightness]	📖 728 , 📖 730
	[Airplane mode]	📖 781
	[Multi-selector power aperture]	📖 673
	[Multi selector exposure comp.]	📖 673
	[Warm display colors]	📖 611
	[View video info]	📖 673

Multi-Selector Power Aperture

Choose whether the multi selector can be used for power aperture. When **[Enable]** is selected, holding  widens the aperture. Holding  narrows the aperture.

Multi Selector Exposure Comp.

Choose whether the multi selector can be used to adjust exposure compensation. Selecting **[Enable]** allows exposure compensation to be set by pressing  or .

View Video Info

View video recording settings. This option can be used to view but not to change the option selected.

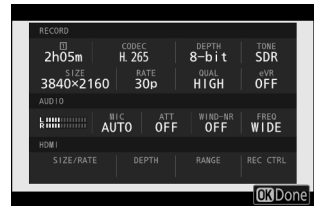









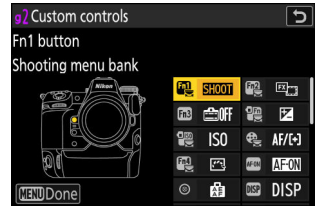





g2: Custom Controls













MENU button ➔ Custom Settings menu

Choose the operations performed in video mode using camera or lens controls, including the camera buttons and sub-selector and the lens control ring.

- Choose the roles played by the controls below. Highlight the desired control and press **OK**.



















Option	
	[Fn1 button]
	[Fn2 button]
	[Fn3 button]
	[Fn button for vertical shooting]
	[Vertical ISO sensitivity button]
	[Focus mode button]
	[Protect/Fn4 button]
	[AF-ON button]
	[Sub-selector center]
	[DISP button]
	[Audio button]
	[OK button]
	[Vertical multi selector center]











Option	
	[QUAL button]
	[Video record button]
	[AF-ON button for vertical shooting]
	[ISO sensitivity button]
	[Exposure compensation button]
	[Shutter-release button]
	[Command dials]
	[Lens Fn button]
	[Lens Fn2 button]
	[Lens Fn ring (counterclockwise)]
	[Lens Fn ring (clockwise)]
	[Lens memory set button]
	[Lens control ring]





- The roles that can be assigned are listed below. The roles available vary with the control.











Role		Description
PRE ⁶³	[Preset focus point]	<p>Pressing the control selects a preset focus point.</p> <ul style="list-style-type: none"> • To choose the point, highlight it, hold the control, and press the focus-mode button until the focus point flashes. • The behavior of the selected control can be chosen by pressing  when [Preset focus point] is highlighted. <ul style="list-style-type: none"> - [Press to recall focus point]: Pressing the control recalls the preset focus point. - [Hold to recall focus point]: The preset focus point is selected while the control is pressed. Releasing the control restores the focus point selected before the control was pressed.







Role		Description
	[Select center focus point]	Pressing the control selects the center focus point.
	[Save focus position]	<p>Holding the control saves the current focus position.</p> <ul style="list-style-type: none"> The saved position can be restored using a control to which [Recall focus position] has been assigned (“memory recall”). When saving the focus position, you can choose whether it can be recalled using any of the controls to which [Recall focus position] is assigned ([Save to all]) or using only a specific control ([Save individually]). For more information, see “Saving and Recalling Focus Positions” (📖 649).
	[Recall focus position]	<p>Pressing the control recalls a focus position saved using a control to which [Save focus position] has been assigned.</p> <ul style="list-style-type: none"> For more information, see “Saving and Recalling Focus Positions” (📖 649).
	[AF-ON]	<p>Pressing the control initiates autofocus, duplicating the function of the AF-ON button.</p> <ul style="list-style-type: none"> When AF-C is selected for focus mode, the camera will focus at the speed selected for Custom Setting g6 [AF speed].
	[Fast AF-ON]	<p>Pressing the control initiates autofocus, duplicating the function of the AF-ON button.</p> <ul style="list-style-type: none"> When AF-C is selected for focus mode, the camera will focus at maximum speed, regardless of the option chosen for Custom Setting g6 [AF speed].
	[AF lock only]	Focus locks while the control is pressed.
	[AE lock (Hold)]	Exposure locks when the control is pressed. Exposure lock does not end when recording begins. Exposure remains locked until the control is pressed a second time or the standby timer expires.

	Role	Description
	[AWB lock (hold)]	If [Auto] or [Natural light auto] is selected for white balance, white balance will lock when the control is pressed (white-balance lock). White-balance lock does not end when recording begins. The lock will however be released when the control is pressed a second time or the standby timer expires.
	[AE/AWB lock (hold)]	Exposure locks when the control is pressed. White balance will also lock provided [Auto] or [Natural light auto] is selected for white balance. Exposure and white-balance lock do not end when recording begins. The lock will however be released when the control is pressed a second time or the standby timer expires.
	[AE lock only]	Exposure locks while the control is pressed.
	[AE/AF lock]	Focus and exposure lock while the control is pressed.
	[Switch FX/DX]	Press the control to switch between [FX] and [DX] image areas.
	[View assist]	Press the control to select [ON] for Custom Setting g11 [View assist] . Press again to select [OFF] .
	[High-frequency flicker reduction]	Pressing the control allows shutter speed to be fine-tuned in smaller increments. Press the control a second time to restore normal shutter-speed selection.
	[Silent mode]	Press the control to enable silent mode. Press again to disable.
DISP	[Cycle live view info display]	Press the control to cycle the shooting display. The type and content of the displays available can be chosen using Custom Settings g16 [Custom monitor shooting display] and g17 [Custom viewfinder shooting display] .
	[Live view info display off]	Press the control to hide icons and other information in the shooting display. Press again to view.
	[Framing grid]	Press the control to display a framing grid. To hide the grid, press the control again. The display type can be selected using Custom Setting g14 [Grid type] .

	Role	Description
	[Zoom on/off]	Press the control to zoom the display in on the area around the current focus point. Press again to cancel zoom.
	[Virtual horizon]	Press the control to enable the virtual horizon display. Press again to hide the display. The display type can be selected using Custom Setting d17 [Virtual horizon type].
	[Focus peaking display]	Press the control once to enable focus peaking when MF is selected for focus mode. Press again to end focus peaking.
	[MY MENU]	Press the control to display "MY MENU".
	[Access top item in MY MENU]	Press the control to jump to the top item in "MY MENU". Select this option for quick access to a frequently-used menu item.
	[Playback]	Press the control to start playback.
	[Filtered playback]	Press the control to view only pictures that meet the criteria selected for [Filtered playback criteria] in the playback menu.
	[Filtered playback (select criteria)]	Press the control to jump to [Filtered playback criteria] in the playback menu.
	[Power aperture (open)]	<ul style="list-style-type: none"> Aperture widens while the button is pressed. This option is enabled automatically when [Power aperture (close)] is selected for [Fn2 button]. Rotate the lens Fn ring counterclockwise to widen the lens aperture. This option is enabled automatically when [Power aperture (close)] is selected for [Lens Fn ring (clockwise)].
	[Power aperture (close)]	<ul style="list-style-type: none"> Aperture narrows while the button is pressed. This option is enabled automatically when [Power aperture (open)] is selected for [Fn1 button]. Rotate the lens Fn ring clockwise to narrow the lens aperture. This option is enabled automatically when [Power aperture (open)] is selected for [Lens Fn ring (counterclockwise)].

	Role	Description
	[Exposure compensation +]	<ul style="list-style-type: none"> Exposure compensation increases while the button is pressed. This option is enabled automatically when [Exposure compensation –] is selected for [Fn2 button]. Rotate the lens Fn ring clockwise for increased exposure compensation. This option is enabled automatically when [Exposure compensation –] is selected for [Lens Fn ring (counterclockwise)].
	[Exposure compensation –]	<ul style="list-style-type: none"> Exposure compensation decreases while the button is pressed. This option is enabled automatically when [Exposure compensation +] is selected for [Fn1 button]. Rotate the lens Fn ring counterclockwise to reduce exposure compensation. This option is enabled automatically when [Exposure compensation +] is selected for [Lens Fn ring (clockwise)].
	[Hi-Res Zoom +]	<ul style="list-style-type: none"> Zoom in using Hi-Res Zoom; the zoom ratio increases while the control is pressed. This option is enabled automatically when [Hi-Res Zoom –] is selected for [Fn2 button]. Rotate the lens Fn ring clockwise to zoom in using Hi-Res Zoom. This option is enabled automatically when [Hi-Res Zoom –] is selected for [Lens Fn ring (counterclockwise)].
	[Hi-Res Zoom –]	<ul style="list-style-type: none"> Zoom out using Hi-Res Zoom; the zoom ratio decreases while the control is pressed. This option is enabled automatically when [Hi-Res Zoom +] is selected for [Fn1 button]. Rotate the lens Fn ring counterclockwise to zoom out using Hi-Res Zoom. This option is enabled automatically when [Hi-Res Zoom +] is selected for [Lens Fn ring (clockwise)].
	[ISO sensitivity (increase)]	Rotate the lens Fn ring clockwise to increase ISO sensitivity. This option is enabled automatically when [ISO sensitivity (decrease)] is selected for [Lens Fn ring (counterclockwise)] .

Role		Description
	[ISO sensitivity (decrease)]	Rotate the lens Fn ring counterclockwise to decrease ISO sensitivity. This option is enabled automatically when [ISO sensitivity (increase)] is selected for [Lens Fn ring (clockwise)] .
	[Pattern tone range]	Press the control to cycle through zebra pattern tone range options.
	[Record videos]	Press the control to start recording. Press again to end recording.
	[Same as AF-ON button]	The control plays the role currently selected for the AF-ON button.
	[Shooting menu bank]	Press the control and rotate a command dial to choose a shooting menu bank.
	[Shooting mode]	Press the control and rotate the main command dial to choose a shooting mode.
	[Choose image area]	Press the control and rotate a command dial to choose the image area for videos. Note that the image area cannot be changed while recording is in progress.
	[Exposure compensation]	Adjust exposure compensation either by holding the control and rotating a command dial or by rotating the lens control ring.
ISO	[ISO sensitivity]	Adjust ISO sensitivity either by holding the control and rotating a command dial or by rotating the lens control ring.
WB	[White balance]	Hold the control and rotate the main command dial to adjust white balance for videos. Some options offer sub-options that can be selected by rotating the sub-command dial.
	[Set Picture Control]	Press the control and rotate a command dial to choose a Picture Control.
	[Active D-Lighting]	Press the control and rotate a command dial to adjust Active D-Lighting for videos.





Role		Description
	[Metering]	Press the control and rotate a command dial to choose a metering option for use during video recording.
AF/[*]	[Focus mode/AF-area mode]	Hold the control and rotate the main command dial to choose the focus mode, the sub-command dial to choose the AF-area mode.
LOCK	[Control lock]	<ul style="list-style-type: none"> • Press the control and rotate the main command dial to lock shutter speed (mode M). To lock aperture (modes A and M), press the control and rotate the sub-command dial. • To lock focus-point selection, hold the control and press , , or .
	[Microphone sensitivity]	Press the control and rotate a command dial to adjust microphone sensitivity.
M/A	[Focus (M/A)]	The lens control ring can be used for manual focus regardless of the option selected for focus mode. To refocus using autofocus, press the shutter-release button halfway or press a control to which AF-ON has been assigned.
	[Power aperture]	Rotate the lens control ring to adjust aperture.
	[Hi-Res Zoom]	Rotate the lens control ring to zoom in or out using Hi-Res Zoom.
[None]		The control has no effect.

Power Aperture

- Power aperture is available only in modes **A** and **M**.
- The display may flicker while aperture is adjusted.

Command Dials



The following roles can be assigned to the command dials. To view options, highlight items and press .

Role	Description
[Exposure setting]	Reverse the roles of the main and sub-command dials in selected modes. Press  or  to highlight a mode and  or  to switch roles.
[Focus/AF-area mode selection]	Switch the roles played by rotating the main and sub-command dials while the focus-mode button is pressed.
[Sub-command dial zoom role]	Choose the role played by the sub-command dial in the zoom display. <ul style="list-style-type: none">• Choose [Exposure setting] to change the role played by the sub-command dial in each mode.• Choose [Zoom] to use the sub-command dial to zoom in or out.

g3: Control Lock

MENU button ➡ Custom Settings menu

Lock exposure settings or focus-point selection.

Option	Description
[Shutter speed lock]	Select [ON] to lock shutter speed at its current value in mode M . <ul style="list-style-type: none">•  icons appear in the shooting display and control panel when shutter-speed lock is in effect.
[Aperture lock]	Select [ON] to lock aperture at its current value in modes A and M . <ul style="list-style-type: none">•  icons appear in the shooting display and control panel when aperture lock is in effect.
[Focus-point lock]	Select [ON] to lock focus-point selection on the currently-selected focus point. <ul style="list-style-type: none">• Focus point lock does not apply when [Auto-area AF] is selected for AF-area mode.• When [Subject-tracking AF] is selected, the focus point will track subject motion.

g4: Limit AF-Area Mode Selection

MENU button ➔ Custom Settings menu

Choose the AF-area modes that can be selected by pressing the focus-mode button and rotating the sub-command dial.

- Highlight options and press \odot or \ominus to select () or deselect (). Modes marked with a check () are available for selection via the sub-command dial.
- To complete the operation, press MENU.

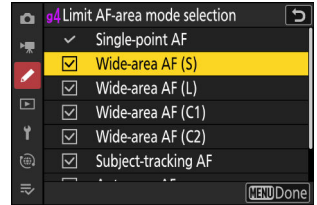

g5: Focus Mode Restrictions

MENU button → Custom Settings menu

Limit focus-mode selection to a single focus mode. If an option other than **[No restrictions]** is selected, rotating the main command dial while holding the focus-mode button will not change the focus mode.

g6: AF Speed

MENU button ➡ Custom Settings menu

Choose the focus speed for video mode.

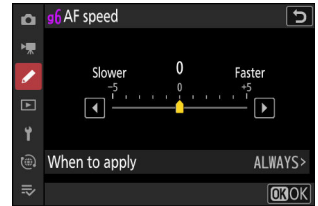

Use [**When to apply**] to choose when the selected option applies.

Option		Description
ALWAYS	[Always]	The camera focuses at the selected speed at all times in video mode.
REC	[Only while recording]	Focus is adjusted at the selected speed only while video recording is in progress. At other times, the camera focuses as quickly as possible.

Lens Sounds

The sound produced by the lens during focus operations increases with AF speed. The effect is particularly noticeable at a setting of [+5], so choose lower values if you find the noise distracting.

g7: AF Tracking Sensitivity

MENU button → Custom Settings menu

The AF tracking sensitivity for video mode can be set to values of from 1 to 7.

- Choose [7] (**Low**) to help maintain focus on your original subject.
- If the subject leaves the selected focus point when [1] (**High**) is selected, the camera will respond by quickly shifting focus to a new subject in the same area.

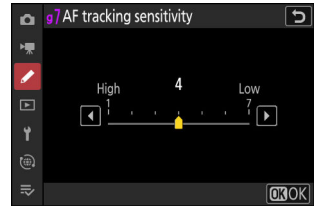

g8: Hi-Res Zoom Speed

MENU button ➡ ✎ Custom Settings menu

Choose the zoom speed for Hi-Res Zoom from **[Slower]**, **[Standard]**, and **[Faster]**. This option only takes effect when Hi-Res Zoom is assigned to a control using any of the **[Fn1 button]**, **[Fn2 button]**, **[Lens Fn ring (clockwise)]**, and **[Lens Fn ring (counterclockwise)]** options for Custom Setting g2 **[Custom controls]**.

g9: Fine ISO Control (Mode M)

MENU button ➔✎ Custom Settings menu

Selecting [**On (1/6 EV)**] allows ISO sensitivity for videos to be adjusted in increments of $\frac{1}{6}$ EV in mode **M**.

- Sensitivity can be set to values of from ISO 64 to 25600 in increments of $\frac{1}{6}$ EV.

g10: Extended Shutter Speeds (Mode M)

MENU button ➔✎ Custom Settings menu

Select **[ON]** for access to a range of slower shutter speeds in mode **M**.

- When **[OFF]** is selected, the minimum shutter speed varies with frame rate as follows.
 - 120p: $\frac{1}{125}$ s
 - 100p: $\frac{1}{100}$ s
 - 60p: $\frac{1}{60}$ s
 - 50p: $\frac{1}{50}$ s
 - 30p: $\frac{1}{30}$ s
 - 25p: $\frac{1}{25}$ s
 - 24p: $\frac{1}{25}$ s
- When **[ON]** is selected, the minimum shutter speeds for frame rates of 60p to 24p drop to $\frac{1}{4}$ s. Those for 120p and 100p do not change.
- Selecting **[ON]** and choosing a slow shutter speed helps prevent ISO sensitivity rising too high during shots of the night sky and other dark subjects.
- Videos recorded at slow shutter speeds when **[ON]** is selected will include repeated multiple copies of the same frames.
- To reduce blur caused by camera shake in videos recorded at slow shutter speeds while **[ON]** is selected, we recommend mounting the camera on a tripod.

g11: View Assist

MENU button ➔✎ Custom Settings menu

Choose **[ON]** for a live preview of video footage recorded with **[HLG]** or **[N-Log]** selected for video tone mode, but note that the colors in the preview are simplified for enhanced contrast.

- Colors in the actual recorded footage are unaffected.
- Contrast is also enhanced when HLG or N-Log footage is viewed on the camera.

g12: Zebra Pattern

MENU button ➔ Custom Settings menu

Choose whether a zebra pattern is used to indicate selected tone ranges in video mode.

Pattern Tone Range

Choose the tone range shown by the zebra pattern from [**Highlights**] or [**Mid-tones**], or select [**Zebra pattern off**] to turn the zebra pattern off. Highlights and mid-tones can be defined using [**Highlight threshold**] and [**Mid-tone range**], respectively.

Pattern

To enable the zebra display, select [**Pattern 1**] or [**Pattern 2**].

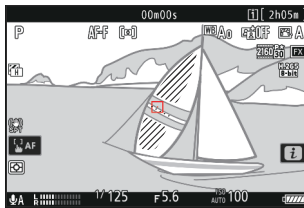

Pattern 1

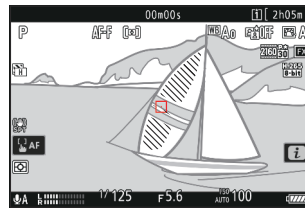

Pattern 2

Highlight Threshold

Choose the brightness needed to trigger the zebra display when [**Highlights**] is selected for [**Pattern tone range**].

- Choose from values of from 120 to 255. The lower the value, the greater the range of brightnesses that will be shown as highlights.
- If 255 is selected, the display will show only areas that are potentially overexposed.

Mid-tone Range

Choose the brightness needed to trigger the zebra display when [Mid-tones] is selected for [Pattern tone range].

- The mid-tone range is defined as a brightness [Value] and [Range] of brightnesses centered around the selected value.
- Press \leftarrow or \rightarrow to highlight items and press \odot or \ominus to change.

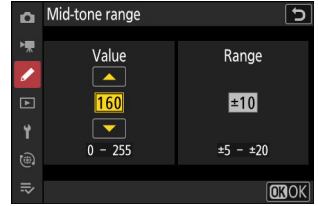

Zebra Pattern

If both the zebra display and focus peaking are enabled in manual focus mode, only focus peaking will take effect. To view the zebra display in manual focus mode, select [OFF] for Custom Setting a13 [Focus peaking] > [Focus peaking display].

g13: Limit Zebra Pattern Tone Range

MENU button ➔ Custom Settings menu

Choose the tone range shown by a zebra pattern when a control previously assigned **[Pattern tone range]** is pressed. If **[Highlights]** or **[Mid-tones]** is selected, pressing the control will display a zebra pattern only over areas in the selected tone range; pressing the button a second time hides the zebra pattern.

g14: Grid Type

MENU button ➡✎ Custom Settings menu

Choose a framing grid for video mode. The selected grid can be displayed by placing a check (☑) next to  in the list for Custom Setting g16 [**Custom monitor shooting display**] ([📖 697](#)) or g17 [**Custom viewfinder shooting display**] ([📖 699](#)).

g15: Brightness Information Display

MENU button ➔ Custom Settings menu

Choose how the camera displays brightness information in video mode.

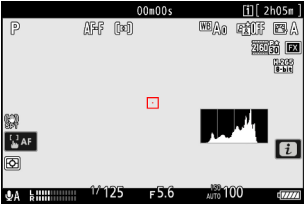
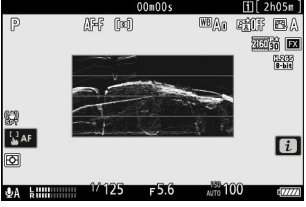
Option	Description
[Histogram]	<p>Enable the RGB histogram.</p> 
<p>[Wave-form monitor]</p> <p>[Wave-form monitor (large)]</p>	<p>The camera displays a wave-form monitor. The monitor can be displayed at either of two different sizes.</p> 

g16: Custom Monitor Shooting Display

MENU button ➔ Custom Settings menu





Choose the monitor displays accessible by pressing the **DISP** button in video mode.

- Highlight items ([**Display 2**] through [**Display 4**]) and press **Ⓢ** to select () or deselect (). Only displays marked with a check () can be accessed by pressing the **DISP** button during shooting. [**Display 1**] cannot be deselected.

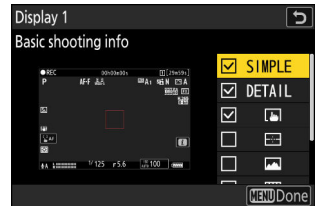

- To choose indicators that appear in displays [**Display 1**] through [**Display 4**], highlight the corresponding option and press **Ⓢ**. You can then highlight items and press **Ⓢ** to select () or deselect ().



	Option	Description
SIMPLE	[Basic shooting info]	View the shooting mode, shutter speed, aperture, and other basic shooting info.
DETAIL	[Detailed shooting info]	View the focus mode, AF-area mode, white balance, and other detailed shooting info.
	[Touch controls]	View options that can be accessed via touch controls, including touch AF and the z menu.
	[Virtual horizon]	Enable the virtual horizon. The display type can be selected using Custom Setting d17 [Virtual horizon type].
	[Brightness information]	View a histogram or wave-form monitor. The display type can be selected using Custom Setting g15 [Brightness information display].
	[Framing grid]	Enable the framing grid. The display type can be selected using Custom Setting g14 [Grid type].

Option		Description
<input type="checkbox"/>	[Center indicator]	Display crosshairs at the center of the frame.

- To complete the operation, press **MENU**.

g17: Custom Viewfinder Shooting Display

MENU button ➔✎ Custom Settings menu

Choose the viewfinder displays accessible by pressing the **DISP** button in video mode.

- Highlight items ([**Display 2**] or [**Display 3**]) and press \odot to select () or deselect (). Only displays marked with a check () can be accessed by pressing the **DISP** button during shooting. [**Display 1**] cannot be deselected.
- To choose indicators that appear in displays [**Display 1**] through [**Display 3**], highlight the corresponding option and press \odot . You can then highlight items and press \odot to select () or deselect (). Apart from [**Touch controls**], the options are the same as those for Custom Setting g16 [**Custom monitor shooting display**] ([📖 697](#)).
- To complete the operation, press MENU.

g18: Red REC Frame Indicator

MENU button ➔✎ Custom Settings menu

If **[ON]** is selected, a red border will appear around the shooting display while video recording is in progress. This helps prevent missed shots by alerting you when recording is in progress.

The Playback Menu: Managing Pictures

Playback Menu

To display the playback menu, select the  (playback menu) tab in the camera menus.

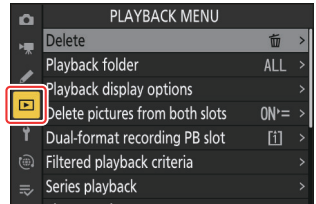

The options in the playback menu are listed below, together with their default settings.





- **[Delete]:** —
- **[Playback folder]:** All
- **[Playback display options]**
 - **[Focus point]:**
 - **[Mark first shot in series]:**
 - **[Exposure info]:**
 - **[Highlights]:**
 - **[RGB histogram]:**
 - **[Shooting data]:**
 - **[Overview]:**
 - **[None (picture only)]:**
 - **[File info]:**
 - **[Basic shooting data]:**
 - **[Flash data]:**
 - **[Picture Control/HLG data]:**
 - **[Other shooting data]:**
 - **[Copyright info]:**
 - **[Location data]:**
 - **[IPTC data]:**
- **[Delete pictures from both slots]:** Yes (confirmation required)
- **[Dual-format recording PB slot]:** Slot 1
- **[Filtered playback criteria]**
 - **[Protect]:**
 - **[Picture type]:**
 - **[Rating]:**

- [Select for upload to computer]:
- [Select for upload (FTP)]:
- [Voice memo]:
- [Retouched pictures]:
- [Series playback]
 - [Sub-selector displays first shot]: ON
 - [Auto series playback]: OFF
 - [List series as single thumbnails]: OFF
- [Picture review]: Off
- [After delete]: Show next
- [After burst, show]: Last picture in burst
- [Auto-rotate pictures]: ON
- [Copy image(s)]: —

Delete

MENU button ➡️▶️ playback menu

Delete multiple pictures. For more information, see “Deleting Multiple Pictures” ([📖 257](#)).

Option		Description
	[Selected pictures]	Delete selected pictures.
	[Candidates for deletion]	Delete pictures rated  (candidate for deletion).
	[Pictures shot on selected dates]	Delete all pictures taken on selected dates.
ALL	[All pictures]	Delete all pictures in the folder currently selected for [Playback folder] in the playback menu. <ul style="list-style-type: none">• If two memory cards are inserted, you can select the card from which pictures will be deleted.

Playback Folder

MENU button ➡️ playback menu

Choose a folder for playback.

Option	Description
(Folder name)	Pictures in all folders with the selected name will be visible during playback. Folders can be renamed using the [Storage folder] > [Rename] option in the photo shooting menu.
[All]	Pictures in all folders will be visible during playback.
[Current]	Only pictures in the current folder will be visible during playback.

Playback Display Options

MENU button ➡️ playback menu

Choose display options for full-frame playback.

- Highlight options and press **OK** to select (☑️) or deselect (☐).
- To complete the operation, press **MENU**.

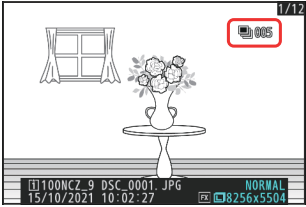
Option	Description
[Focus point]	Select (☑️) this option to view the location of the focus point used when the picture was taken.
[Mark first shot in series]	<p>When this option is selected (☑️), the first picture in each burst will be identified by a 📷 icon and a figure giving the total number of shots in the burst.</p> 
[Exposure info]	<p>The selected (☑️) information displays can be viewed using the DISP button or by pressing OK or DISP.</p>
[Highlights]	
[RGB histogram]	
[Shooting data]	
[Overview]	
[None (picture only)]	
[File info]	

Option	Description
[Basic shooting data]	The selected (☑) options are included in the full-frame playback [Shooting data] display.
[Flash data]	
[Picture Control/HLG data]	
[Other shooting data]	
[Copyright info]	
[Location data]	
[IPTC data]	

Delete Pictures from Both Slots

MENU button → playback menu

Choose whether deleting a copy of a picture recorded to both memory cards with either **[Backup]** or a dual-format option (**[RAW Slot 1 - JPEG Slot 2]** or **[JPEG Slot 1 - JPEG Slot 2]**) selected for **[Role played by card in Slot 2]** in the photo shooting menu also deletes the remaining copy.

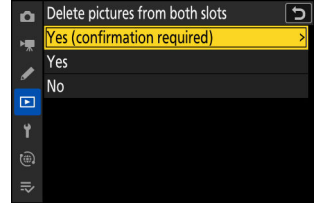

Option	Description
[Yes (confirmation required)]	Before deleting one copy, you will be prompted to choose whether to delete the other. To choose the option highlighted by default, press [OK] .
[Yes]	[Same pictures on [1] and [2]] is always selected; selecting [Yes] in the confirmation dialog deletes both copies.
[No]	The confirmation dialog displayed is the same as that for pictures for which no second copy exists. Deleting the current picture does not delete the copy.

Dual-Format Recording PB Slot

MENU button ➡️ playback menu

Choose the slot from which dual-format pictures recorded with **[RAW Slot 1 - JPEG Slot 2]** or **[JPEG Slot 1 - JPEG Slot 2]** selected for **[Role played by card in Slot 2]** in the photo shooting menu are played back.

Filtered Playback Criteria

MENU button ➡️  playback menu

Choose the criteria used to choose the pictures displayed during filtered playback ([📖 252](#)).

Series Playback

MENU button →  playback menu

Choose options for viewing bursts (series) of shots taken during burst photography.

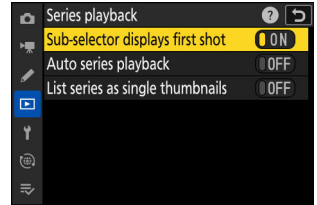

Sub-selector Displays First Shot

Option	Description
[ON]	Skip all but the first shot in each burst when scrolling through pictures by tilting the sub-selector left or right. Pictures that are not part of a burst will not be skipped. The individual shots in each burst can be viewed by tilting the sub-selector up or down.
[OFF]	The sub-selector performs the same functions as the multi selector when tilted up, down, left, or right.

Auto Series Playback

If [ON] is selected, the remaining pictures will play back automatically after the first picture in the burst has been displayed full frame for a few seconds. Playback ends when the last picture in the burst is displayed.

List Series as Single Thumbnails

When [ON] is selected, only the first shot in each burst will appear in the thumbnail list. The first picture in each burst will be identified by a  icon and a figure giving the total number of shots in the burst.

- All the pictures in each burst will be displayed during full-frame playback.
- Selecting [ON] for [List series as single thumbnails] allows access to [Manage series] in the playback  menu ([240](#)).

Picture Review

MENU button ➡  playback menu



Choose whether pictures are automatically displayed immediately after shooting.

Option	Description
[On]	Pictures appear in the currently-selected display (monitor or viewfinder) as they are taken. <ul style="list-style-type: none">• When [Prioritize viewfinder (2)] is selected for monitor mode, the most recent picture will be displayed in the monitor when you take your eye from the viewfinder.
[On (monitor only)]	Pictures are displayed after shooting only when the monitor is used to frame shots. Pictures are not displayed in the viewfinder when [Viewfinder only] is selected for monitor mode.
[Off]	Pictures can only be viewed by pressing the  button.

After Delete

MENU button ➡️ playback menu

Choose the picture displayed after an image is deleted.

	Option	Description
	[Show next]	<ul style="list-style-type: none">• The following picture is displayed.• If the deleted picture was the last picture, the preceding picture will be displayed.
	[Show previous]	<ul style="list-style-type: none">• The preceding picture is displayed.• If the deleted picture was the first picture, the next picture will be displayed.
	[Continue as before]	<ul style="list-style-type: none">• If you were scrolling through pictures in the order recorded, the following picture will be displayed as described for [Show next].• If you were scrolling through pictures in reverse order, the preceding picture will be displayed as described for [Show previous].

After Burst, Show

MENU button ➡▶ playback menu

Choose whether the photo displayed immediately after a burst of shots is taken in continuous mode is the first or last shot in the burst.

- This option takes effect only when **[Off]** is selected for **[Picture review]** in the playback menu.

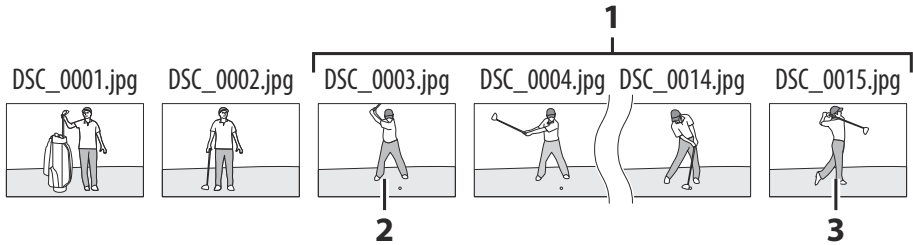

- 1** Most recent shots (burst)
- 2** Displayed if **[First picture in burst]** is selected
- 3** Displayed if **[Last picture in burst]** is selected

Auto-Rotate Pictures

MENU button ➡  playback menu

Select **[ON]** to automatically rotate “tall” (portrait) and “wide” (landscape) orientation pictures according to how the camera is held during playback: tall pictures will be rotated to display in tall orientation when the camera is held in wide orientation, while wide pictures will be rotated to display in wide orientation when the camera is held in tall orientation.

Caution: Auto-Rotate Pictures

Pictures are not rotated automatically during picture review even when **[ON]** is selected for **[Auto-rotate pictures]**.

Copy Image(s)

MENU button → playback menu

Copy pictures from one memory card to another when two memory cards are inserted.

Option	Description
[Select source]	Choose the card from which pictures will be copied.
[Select picture(s)]	Select pictures to be copied.
[Select destination folder]	Select the destination folder on the remaining card (the card not selected for [Select source]).
[Copy picture(s)?]	Copy the pictures.

Copying Pictures

1 Choose [Select source].

Highlight [Select source] and press **▶** to display the [Select source] dialog.

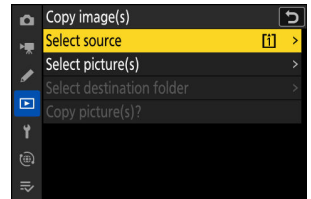

2 Select the card containing the pictures to be copied.

Highlight the slot for the card containing the pictures to be copied and press **Ⓢ** to select the highlighted slot and return to the [Copy image(s)] menu.

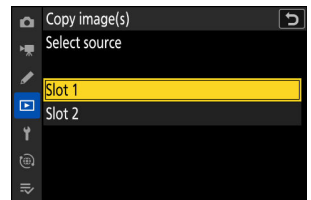

3 Choose [Select picture(s)].

Highlight **[Select picture(s)]** and press **↵** to view the **[Select picture(s)]** display.

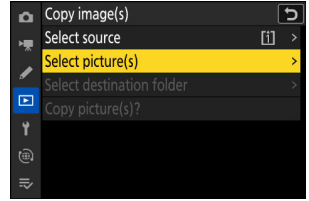

4 Select the source folder.

- Highlight the folder containing the pictures to be copied and press **↵** to display the **[Images selected by default]** menu.
- To copy all pictures from the card in the selected slot, highlight **[All pictures in slot]**, press **⌘**, and proceed to Step 10.

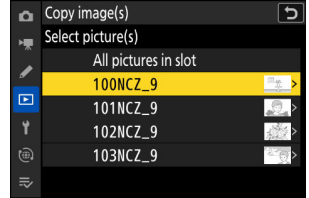



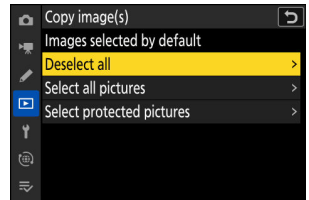

5 Make the initial selection.

Choose the pictures that will be selected by default.



Option	Description
[Deselect all]	None of the pictures in the chosen folder will be selected by default. <ul style="list-style-type: none">• Choose this option when you want to select pictures individually.
[Select all pictures]	All of the pictures in the chosen folder will be selected by default. <ul style="list-style-type: none">• Choose this option if you want to copy all or most of the pictures in the folder.
[Select protected pictures]	Only the protected pictures in the folder will be selected by default.

6 Select additional pictures.

- Highlight pictures and press the  (?) button to select; selected pictures are marked with a check (✓). To remove the check (○) and deselect the current picture, press the  (?) button again.
- To view the highlighted picture full screen, press and hold the  button.
- After confirming that all the pictures you want to copy have ✓ marks, press  to return to the **[Copy image(s)]** menu.

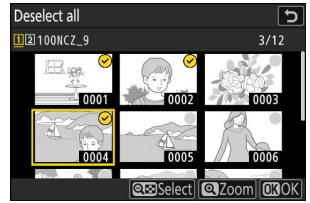

7 Choose [Select destination folder].

Highlight **[Select destination folder]** and press  to display **[Select destination folder]** options.

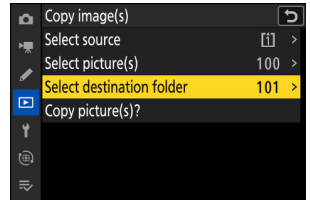

8 Choose a destination folder.

Highlight one of the following options and press **[Enter]**.

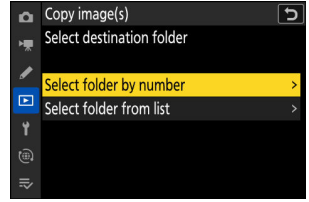

Option	Description
[Select folder by number]	Enter the number of the destination folder (link 443). If a folder with the selected number does not already exist, a new folder will be created.
[Select folder from list]	Choose the destination folder from a list of existing folders.

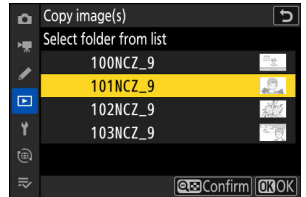
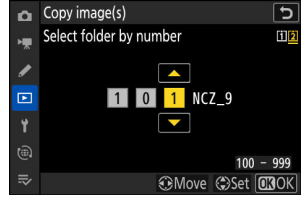

9 Select the folder.

After entering a folder number or highlighting the folder name, press **[Enter]** to select the folder and return to the **[Copy image(s)]** menu.

10 Choose **[Copy picture(s)?]**.

Highlight **[Copy picture(s)?]** and press **[Enter]** to display a confirmation dialog.

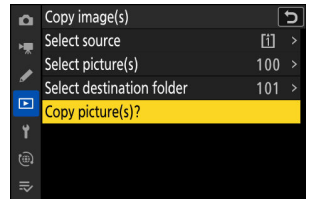

11 Choose [Yes].

- The camera will display the message “[Copy?]” together with the number of pictures that will be copied.
- Highlight [Yes] and press \odot to copy the selected pictures.
- Press \odot again to exit when copying is complete.

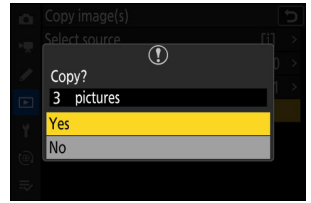

✓ Cautions: Copying Pictures

- Pictures will not be copied if there is insufficient space on the destination card.
- If the destination folder contains a file with the same name as one of the pictures to be copied, a confirmation dialog will be displayed. Select **[Replace existing picture]** or **[Replace all]** to replace the existing file or files. Protected files in the destination folder will not be replaced. Select **[Skip]** to continue without replacing existing files. Select **[Cancel]** to exit without copying any further pictures.

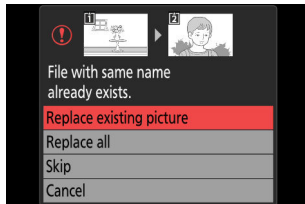

- Ratings and protection are copied with the pictures.
 - To prevent loss of power while copying is in progress, be sure the battery is fully charged or connect the supplied charging AC adapter or an optional AC adapter and power connector before copying videos.
-

The Setup Menu: Camera Setup

Setup Menu

To view the setup menu, select the **Y** tab in the camera menus.

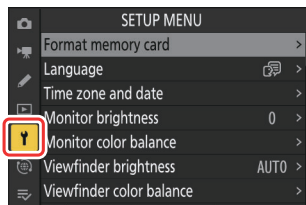

The options in the setup menu are listed below, together with their default settings.

- **[Format memory card]:** —
- **[Language]:** (Default varies with country of purchase)
- **[Time zone and date]**
 - **[Time zone]:** (Default varies with country of purchase)
 - **[Date and time]:** —
 - **[Date format]:** (Default varies with country of purchase)
 - **[Daylight saving time]:** OFF
- **[Monitor brightness]:** 0
- **[Monitor color balance]:** A-B: 0, G-M: 0
- **[Viewfinder brightness]:** Auto
- **[Viewfinder color balance]:** A-B: 0, G-M: 0
- **[Finder display size (photo Lv)]:** Standard
- **[Limit monitor mode selection]**
 - **[Automatic display switch]:**
 - **[Viewfinder only]:**
 - **[Monitor only]:**
 - **[Prioritize viewfinder (1)]:**
 - **[Prioritize viewfinder (2)]:**
- **[Auto rotate info display]:** ON
- **[AF fine-tuning options]**
 - **[AF fine-tune]:** OFF
 - **[Fine-tune and save lens]:** —
 - **[Default]:** —
 - **[List saved values]:** —
 - **[Choose value for current lens]:** —
- **[Non-CPU lens data]**
 - **[Lens number]:** 1
 - **[Focal length (mm)]:** --

- [Maximum aperture]: --
- [Save focus position]: OFF
- [Auto temperature cutout]: Standard
- [Sensor shield behavior at power off]: Sensor shield stays open
- [Clean image sensor]
 - [Automatic cleaning]: Clean at shutdown
- [Image Dust Off ref photo]: —
- [Pixel mapping]: —
- [Image comment]
 - [Attach comment]: OFF
- [Copyright information]
 - [Attach copyright information]: OFF
- [IPTC]
 - [Edit/save]: —
 - [Delete]: —
 - [Auto embed during shooting]: Off
 - [Load/save]: —
- [Voice memo options]
 - [Voice memo control]: Press and hold
 - [Audio output (playback)]: Speaker/headphones
- [Camera sounds]
 - [Shutter sound]: ON
 - [Beep on/off]: Off
 - [Volume]: 2
 - [Pitch]: Low
- [Silent mode]: OFF
- [Touch controls]
 - [Enable/disable touch controls]: Enable
 - [Glove mode]: OFF
- [HDMI]
 - [Output resolution]: Auto
 - [Output range]: Auto
 - [Output shooting info]: ON
 - [Mirror camera info display]: ON
- [USB connection priority]: Upload
- [Location data (built-in)]
 - [Record location data]: OFF
 - [Standby timer]: ON
 - [Set clock from satellite]: OFF
 - [Create log]: —
 - [Log list]: —
 - [Position]: —
- [Wireless remote (WR) options]

- [**LED lamp**]: ON
- [**Link mode**]: Pairing
- [**Assign remote (WR) Fn button**]: None
- [**Conformity marking**]: —
- [**Battery info**]: —
- [**USB power delivery**]: ON
- [**Energy saving (photo mode)**]: OFF
- [**Slot empty release lock**]: Enable release
- [**Save/load menu settings**]: —
- [**Reset all settings**]: —
- [**Firmware version**]: —

Format Memory Card

MENU button →  setup menu

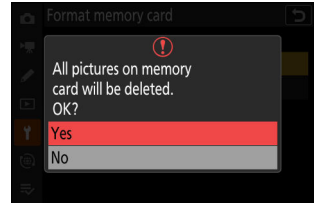

Format memory cards. Memory cards that have been formatted in a computer or another camera should be reformatted using this option before use. To begin formatting, choose a memory card slot and select [**Yes**]. *Note that formatting permanently deletes all pictures and other data on the card.* Before formatting, be sure to make backup copies as required.



Caution: During Formatting

Do not turn the camera off or remove memory cards until the message [**Formatting memory card**] clears from the display.

Tip: The Format Buttons

Keeping both format (/ISO/) and ISO/) buttons pressed for over two seconds displays a dialog prompting you to select a card for formatting.

“Yes (Full Format)”

When formatting compatible CFexpress memory cards, instead of a simple **[Yes]** you will be presented with **[Yes (full format)]** and **[Yes (quick format)]** options after selecting the memory card slot.

- Select **[Yes (full format)]** to perform a full format, deleting data from all areas of the card. This option is recommended for users who wish to ensure that all data are deleted or who feel that the speed at which the camera reads from and writes to the card has slowed and wish to improve data transfer speeds.
- To format the card using the existing format method, select **[Yes (quick format)]**.

Caution: Full Format

A full format takes longer than a quick format.

Tip: “Quick Format” Versus “Full Format”

A quick format overwrites only the file system information, leaving the actual file data intact. In contrast, performing a full format on a CFexpress memory card deletes all data. We recommend fully-formatting CFexpress memory cards prior to disposal or transfer of ownership.

Language

MENU button ➡  setup menu

Choose a language for camera menus and messages. The languages available vary with the country or region in which the camera was originally purchased.

Time Zone and Date

MENU button →  setup menu



Change time zones and set the camera clock. We recommend that the camera clock be adjusted regularly.

Option	Description
[Time zone]	Choose a time zone. The time selected for [Date and time] is automatically adjusted for the new time zone.
[Date and time]	Set the camera clock to the current time in the selected [Time zone].
[Date format]	Choose the order in which the day, month, and year are displayed.
[Daylight saving time]	Turn daylight saving time [ON] or [OFF]. Selecting [ON] automatically advances the clock one hour. The default setting is [OFF].

A flashing  icon in the shooting display indicates that the clock has not been set.

Monitor Brightness

MENU button ➡️ setup menu

Press  or  to adjust monitor brightness. Choose higher values for increased brightness, lower values for reduced brightness.

- **[Monitor brightness]** can only be adjusted when the monitor is the active display. It cannot be adjusted when **[Viewfinder only]** is selected for monitor mode or when your eye is to the viewfinder.
- Higher values increase the drain on the battery.

Monitor Color Balance

MENU button → setup menu

Adjust monitor color balance to your taste.

- **[Monitor color balance]** can only be adjusted when the monitor is the active display. It cannot be adjusted when **[Viewfinder only]** is selected for monitor mode or when your eye is to the viewfinder.
- Color balance is adjusted using the multi selector. Press , , , or to adjust color balance as shown below. Press to save changes.

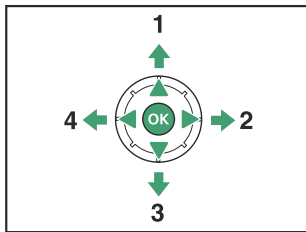
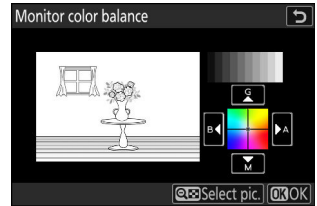

- 1 Increase green
- 2 Increase amber
- 3 Increase magenta
- 4 Increase blue

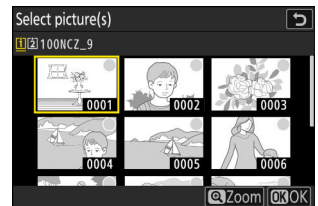

- Monitor color balance applies only to menus, playback, and the shooting display; photos and videos taken with the camera are not affected.
- The reference image is either the last picture taken or, in playback mode, the picture last displayed. If the memory card contains no pictures, an empty frame will be displayed instead.
- To choose a different picture, press the (?). Highlight the desired picture and press to select it as the reference image.
- To view the highlighted picture full frame, press and hold .



Viewfinder Brightness

MENU button →  setup menu

- Adjust viewfinder brightness. **[Viewfinder brightness]** can only be adjusted when the viewfinder is the active display. It cannot be adjusted when the monitor is on or when **[Monitor only]** is selected for monitor mode.
- Higher values increase the drain on the battery.

Option	Description
[Auto]	Viewfinder brightness is adjusted automatically in response to lighting conditions.
[Manual]	Press  or  to adjust brightness manually. Choose higher values for increased brightness, lower values for reduced brightness.

Viewfinder Color Balance

MENU button →  setup menu

Adjust viewfinder color balance to your taste. **[Viewfinder color balance]** can only be adjusted when the viewfinder is the active display. It cannot be adjusted when the monitor is on or when **[Monitor only]** is selected for monitor mode. Otherwise the procedure is the same as for **[Monitor color balance]** ([📖 729](#)).

Finder Display Size (Photo Lv)





MENU button →  setup menu

Choose a magnification for the viewfinder display from [**Standard**] and [**Small**]. Selecting [**Small**] makes it easier to see the entire subject.

Limit Monitor Mode Selection

MENU button →  setup menu

Choose the monitor modes that can be selected using the  button.

- Highlight options and press  or  to select () or deselect (). Options marked with a check () are available for selection.
- To complete the operation, press MENU.

Auto Rotate Info Display

MENU button →  setup menu







When **[ON]** is selected, the indicators in the shooting display will automatically be rotated to match camera orientation.

AF Fine-Tuning Options

MENU button →  setup menu

Fine-tune focus for the current lens.

- Use only as required.
- We recommend that you perform fine-tuning at a focus distance you use frequently. If you perform focus-tuning at a short focus distance, for example, you may find it less effective at longer distances.

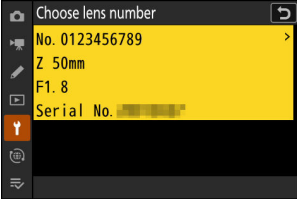
Option	Description
[AF fine-tune]	Select [ON] to turn fine-tuning on.
[Fine-tune and save lens]	<p>Fine-tune focus for the current lens. Press  or  to highlight items and press  or  to choose from values between +20 and -20.</p> <ul style="list-style-type: none">• The larger the fine-tuning value, the farther the focal point is from the lens; the smaller the value, the closer the focal point.• The display shows the current and previous values.• The camera can store values for up to 40 lens types.• If a value already exists for the current lens, you can choose whether to add a new value or overwrite the existing value.
[Default]	<p>Choose the fine-tuning values for lenses for which no values have previously been saved using [Fine-tune and save lens]. Press  or  to choose from values between +20 and -20.</p>
[List saved values]	<p>List values saved using [Fine-tune and save lens]. Highlighting a lens in the list and pressing  displays a [Choose lens number] dialog.</p>  <ul style="list-style-type: none">• The [Choose lens number] dialog is used to enter the lens identifier.• In the case of Z mount lenses and some F mount lenses, the lens serial number is entered automatically.

Option	Description
[Choose value for current lens]	Choose from multiple fine-tuning values saved for lenses of the same type.

Deleting Saved Values



To delete values saved using [Fine-tune and save lens], highlight the desired lens in the [List saved values] list and press  (DELETE).

Creating and Saving Fine-Tuning Values

- 1 Attach the lens to the camera.
- 2 **Select [AF fine-tuning options] in the setup menu, then highlight [Fine-tune and save lens] and press .**

An AF fine-tuning dialog will be displayed.

- 3 **Press  or  to fine-tune autofocus.**

- Choose from values between +20 and -20.
- The current value is shown by ▲, the previously-selected value by △.
- If a zoom lens is attached, you can choose separate fine-tuning values for maximum angle (WIDE) and maximum zoom (TELE). Use  and  to choose between the two.
- The larger the fine-tuning value, the farther the focal point is from the lens; the smaller the value, the closer the focal point.

- 4 **Press  to save the new value.**

Choosing a Default Fine-Tuning Value

- 1 Select **[AF fine-tuning options]** in the setup menu, then highlight **[Default]** and press \odot .

- 2 Press \leftarrow or \rightarrow to fine-tune autofocus.
 - Choose from values between +20 and -20.
 - The current value is shown by ▲, the previously-selected value by Δ.
 - The larger the fine-tuning value, the farther the focal point is from the lens; the smaller the value, the closer the focal point.

- 3 Press \odot to save the new value.

Non-CPU Lens Data

MENU button →  setup menu

Record data for non-CPU lenses attached using an optional mount adapter. Recording the focal length and maximum aperture of non-CPU lenses allows them to be used with some camera features normally reserved for CPU lenses, such as on-board vibration reduction.

Option	Description
[Lens number]	Choose a lens identifier.
[Focal length (mm)]	Enter the focal length.
[Maximum aperture]	Enter the maximum aperture.

Save Focus Position

MENU button →  setup menu





When **[ON]** is selected, the camera will save the current focus position when turned off and restore it when next turned on. Note that this increases camera startup times.

- Note that even when **[ON]** is selected, if the temperature, zoom position, or other conditions change while the camera is off, focus may resume from a different position when the camera is turned on.
- Similarly, note that even when **[OFF]** is selected, focus may resume from the previously-selected position depending on the state of the camera and lens.

Auto Temperature Cutout

MENU button →  setup menu

The level at which the camera will turn off automatically as its internal temperature rises can be selected from **[Standard]** and **[High]**.

- When **[Standard]** is selected, the camera will display first a  and then a  icon as its internal temperature rises, switching to a count-down timer if the temperature increases still further.
- When **[High]** is selected, the camera will display , , and  icons as its internal temperature rises, switching to a count-down timer if the temperature increases still further.
- When the count-down timer reaches zero, the camera will turn off automatically and further photography will be suspended.

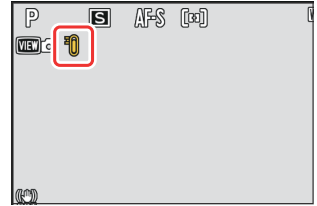

Caution: “High”

Although selecting **[High]** gives you more time before the camera shuts down, the camera may become hot to the touch. We recommend using a tripod or other equipment to reduce the time spent touching the camera.

Cautions: When the Camera Is Hot

- In some cases, the count-down timer may be displayed the moment the camera is turned on, even when **[High]** is selected.
 - Image quality may drop when the camera is hot.
 - Memory cards inserted in a hot camera may also become hot. Wait for the temperature to drop before handling the camera or memory cards.
-

Sensor Shield Behavior at Power Off

MENU button →  setup menu

If **[Sensor shield closes]** is selected, the shield in front of the image sensor will close when the camera is turned off. This prevents dust or other foreign matter collecting on the image sensor when lenses are exchanged. It may also, however, increase camera startup times.

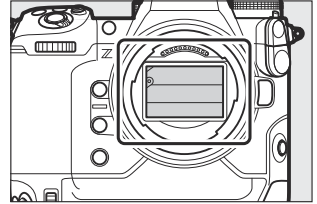

Cautions: The Sensor Shield

- The shield can be damaged by touching it when it is closed.
 - When exchanging lenses with the shield closed, be sure to insert the lens perpendicular to the mount. If inserted at an angle, lenses could contact the sensor shield and damage the shield or the image sensor.
-

Clean Image Sensor

MENU button ➡  setup menu

Dirt or dust entering the camera when lenses are exchanged or the body cap is removed may adhere to the image sensor and affect your photographs. The “clean image sensor” option vibrates the sensor to remove dust.

Option	Description
[Start]	Perform image sensor cleaning immediately.
[Automatic cleaning]	<ul style="list-style-type: none">• [Clean at shutdown]: The image sensor is automatically cleaned during shutdown each time the camera is turned off.• [Cleaning off]: Automatic image sensor cleaning off.

Image Dust Off Ref Photo

MENU button →  setup menu

Acquire reference data for the Image Dust Off option in NX Studio. Image Dust Off processes NEF (RAW) pictures to mitigate effects caused by dust adhering in front of the camera image sensor. For more information, refer to NX Studio's online help.

Acquiring Image Dust Off Reference Data

1 Choose a start option.

- Highlight **[Start]** and press  to immediately display the **[Image Dust Off ref photo]** dialog.

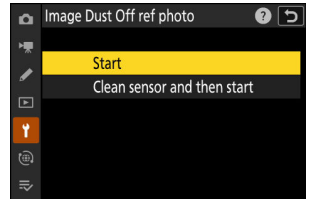

- Highlight **[Clean sensor and then start]** and press  to clean the image sensor before starting. The **[Image Dust Off ref photo]** dialog will be displayed when image sensor cleaning is complete.
- To exit without acquiring Image Dust Off reference data, press MENU.

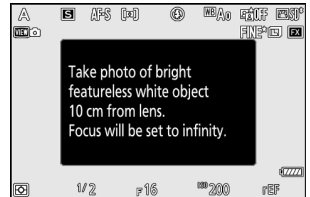

2 With the lens about ten centimeters (four inches) from a well-lit, featureless white object, frame the object so that it fills the display and then press the shutter-release button halfway.

- In autofocus mode, focus will automatically be set to infinity.
- In manual focus mode, set focus to infinity manually.

3 Press the shutter-release button the rest of the way down to acquire Image Dust Off reference data.

- The monitor turns off when the shutter-release button is pressed.
- If the reference object is too bright or too dark, the camera may be unable to acquire Image Dust Off reference data, in which case a message will appear and the camera will return to the display shown in Step 1. Choose another reference object and press the shutter-release button again.



✔ Caution: Image Sensor Cleaning

Dust off reference data recorded before image sensor cleaning is performed cannot be used with photographs taken after image sensor cleaning is performed. Select **[Clean sensor and then start]** only if the Image Dust Off reference data will not be used with existing photographs.

✔ Cautions: Acquiring Image Dust Off Reference Data

- An FX-format lens with a focal length of at least 50 mm is recommended.
- When using a zoom lens, zoom all the way in.
- Image Dust Off data cannot be acquired when a DX lens is attached.
- The same reference data can be used for photographs taken with different lenses or at different apertures.
- Reference images cannot be viewed using computer imaging software.
- A grid pattern is displayed when reference images are viewed on the camera.

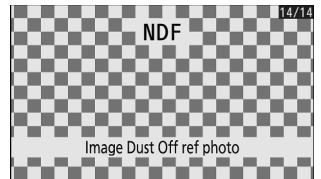

Pixel Mapping

MENU button →  setup menu

Pixel mapping checks and optimizes the camera image sensor. If you notice unexpected bright spots appearing in pictures taken with the camera, perform pixel mapping as described below.

- Pixel mapping is available only when a Z mount lens or an optional FTZ II/FTZ mount adapter is attached.
- To prevent unexpected loss of power, use a fully-charged battery, the supplied charging AC adapter, or an optional AC adapter and power connector.
- To start pixel mapping, select **[Start]**. A message is displayed while the operation is in progress.

Cautions: Pixel Mapping

- Do not attempt to operate the camera while pixel mapping is in progress. Do not turn the camera off or remove or disconnect the power source.
 - Pixel mapping may not be available if the camera's internal temperature is elevated.
-

Image Comment

MENU button →  setup menu

Add a comment to new photographs as they are taken. Comments can be viewed in the NX Studio **[Info]** tab.

Input Comment

Input a comment of up to 36 characters. Highlight **[Input comment]** and press  to display a text-entry dialog. For information on text entry, see “Text Entry” ([71](#)).

Attach Comment

Comments will be attached to pictures taken while **[Attach comment]** is **[ON]**.

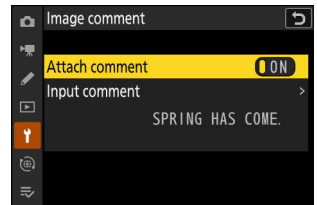



Photo Info

- Comments can be viewed on the **[Other shooting data]** page in the photo information display.
 - To display the **[Other shooting data]** page, select  both **[Shooting data]** and **[Other shooting data]** for **[Playback display options]** in the playback menu.
-

Copyright Information

MENU button →  setup menu

Add copyright information to new photographs as they are taken. Copyright information can be viewed in the NX Studio **[Info]** tab.

Artist/Copyright

Enter the names of the photographer (maximum 36 characters) and copyright holder (maximum 54 characters). Highlight **[Artist]** or **[Copyright]** and press  to display a text-entry dialog. For information on text entry, see “Text Entry” ([📖 71](#)).

Attach Copyright Information

Copyright information will be attached to pictures taken while **[Attach copyright information]** is **[ON]**.



Cautions: Copyright Information

- To prevent unauthorized use of the artist or copyright holder names, make sure that **[OFF]** is selected for **[Attach copyright information]** before lending or transferring the camera to another person. You will also need to make sure that the artist and copyright fields are blank.
- Nikon does not accept liability for any damages or disputes arising from the use of the **[Copyright information]** option.

Viewing Copyright Information

- Copyright information can be viewed on the **[Copyright info]** page in the photo information display.
- To display the **[Copyright info]** page, select both **[Shooting data]** and **[Copyright info]** for **[Playback display options]** in the playback menu.

IPTC

MENU button →  setup menu



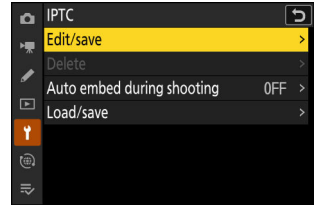

IPTC presets can be created or edited on the camera and embedded in new photographs as described below.

- You can also load IPTC presets created on a computer.
- To create IPTC presets and save them to memory cards for later import, use IPTC Preset Manager ([📖 753](#)).



Creating, Renaming, Editing, and Copying Presets

Highlight **[Edit/save]** and press  to display the **[Select preset to edit or save]** list of existing presets.

- To edit or rename a preset, highlight it and press . To create a new preset, highlight “Unused” and press .
- **[Rename]**: Rename the preset.
- **[Edit IPTC information]**: Display the selected preset ([📖 752](#)). Selected fields can be edited as desired.
- To copy a preset, highlight it and press . Highlight the destination, press , and name the copy.

Deleting Presets

To delete presets, highlight **[Delete]** and press .

Embedding Presets

Highlighting **[Auto embed during shooting]** and pressing **☞** displays a list of presets. Highlight a preset and press **☞**; the selected preset will be embedded in all subsequent photographs. To disable embedding, select **[Off]**.

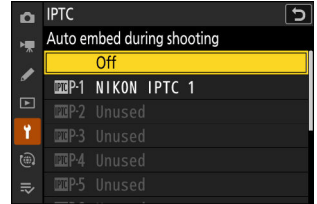

Viewing IPTC Data







- Embedded presets can be viewed on the **[IPTC data]** page in the photo information display.
 - To display the **[IPTC data]** page, select both **[Shooting data]** and **[IPTC data]** for **[Playback display options]** in the playback menu.
-

Copying Presets to a Memory Card

To copy IPTC presets from the camera to a memory card, select **[Load/save] > [Slot 1]** or **[Slot 2]**, then highlight **[Copy to card]** and press **☞**. Select the desired preset and destination (1–99) and press **☞** to copy the preset to the card.

Copying Presets to the Camera

The camera can store up to ten presets; to copy IPTC presets from a memory card to a selected destination on the camera, select [**Load/save**] > [**Slot 1**] or [**Slot 2**], then highlight [**Copy to camera**] and press .

- Highlight a preset and press  to proceed to the [**Select destination**] list. To preview the highlighted preset, press  (?) instead of pressing . After previewing the preset, press  to proceed to the [**Select destination**] list.
- Highlight a destination and press  to display a dialog where you can name the preset. Name the preset as desired and press  to copy the preset to the camera.
- In addition to the ten presets mentioned above, the camera can store up to three XMP/IPTC presets created on a computer and saved in XMP format. XMP/IPTC presets are not displayed during playback. Nor can they be copied from the camera to a memory card.

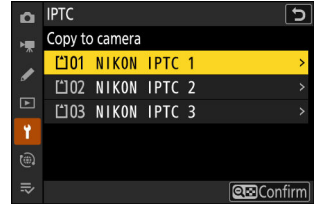

✔ Cautions: IPTC Information

- The camera supports standard roman alphanumeric characters only. Other characters will not display correctly except on a computer.
- Preset names ([📖 749](#)) may be up to 18 characters long. If a preset with a longer name is created using a computer, all characters after the eighteenth will be deleted.
- The number of characters that may appear in each field is given below. Any characters over the limit will be deleted.

Field	Max. length
Caption	2000
Event ID	64
Headline	256
Object name	256
City	256
State	256
Country	256
Category	3
Supp. Cat. (supplemental categories)	256
Byline	256
Byline title	256
Writer/editor	256
Credit	256
Source	256

IPTC

IPTC is a standard established by the International Press Telecommunications Council (IPTC) with the intent of clarifying and simplifying the information required when photographs are shared with a variety of publications.

IPTC Preset Manager

IPTC presets can be created on a computer and saved to memory cards using IPTC Preset Manager software. IPTC Preset Manager can be downloaded free of charge from the URL below.

<https://downloadcenter.nikonimglib.com/>





Voice Memo Options

MENU button →  setup menu

Adjust settings for voice memos ([📖 292](#), [📖 294](#)).

Voice Memo Control

Choose how the  button behaves when used to record voice memos.

Option		Description
	[Press and hold]	Voice memos up to 60 seconds long can be recorded while  button is pressed.
	[Press to start/stop]	Recording begins when  button is pressed and ends after about 60 seconds or when the control is pressed a second time.

Audio Output (Playback)

Choose the device used for voice memo playback.

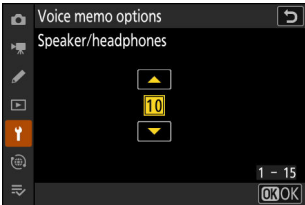
Option	Description
<p>🔊 [Speaker/headphones]</p>	<p>Voice memos are played back over headphones (if connected) or the camera's built-in speaker.</p>  <ul style="list-style-type: none">• Press ⏪ or ⏩ to choose a volume between [1] and [15].• Press ⏹ to save changes and exit.
<p>HDMI [HDMI]</p>	<p>Voice memos are output to the HDMI terminal at a fixed volume.</p>
<p>🔇 [Off]</p>	<p>Voice memos cannot be played even using the 🗣️ button. 🚫 icons are displayed when photographs for which memo exist are viewed in the monitor.</p>

Camera Sounds

MENU button ➡️ setup menu

Shutter Sound

Choose whether the camera makes a sound when the shutter is released. Selecting [**OFF**] disables the shutter-release sound.

Beep On/Off

Turn the beep speaker on or off.

- If [**On**] is selected for [**Beep on/off**], beeps sound when:
 - the self-timer counts down,
 - interval-timer photography, time-lapse video recording, or focus shift ends,
 - the camera focuses in photo mode (note that this does not apply if **AF-C** is selected for focus mode or if [**Release**] is selected for Custom Setting a2 [**AF-S priority selection**]), or
 - touch controls are used.
- Select [**Off (touch controls only)**] to disable the beep for touch controls while enabling it for other purposes.

Volume

Adjust beep volume and the volume of the shutter-release sound.

Pitch

Choose the pitch of the beep from [**High**] and [**Low**]. The pitch of the shutter sound cannot be changed.

Silent Mode

Selecting [**ON**] for [**Silent mode**] in the setup menu disables the shutter-release sound and beep speaker.

Caution: Camera Sounds

Overlapping beeps and/or shutter sounds may play as a single sound.

Silent Mode

MENU button ➡  setup menu

Select **[ON]** to override the options selected for **[Camera sounds]** in the setup menu and mute the electronic shutter and beep speaker during photography.

- Selecting **[ON]** also suppresses other camera sounds. It does not, however, completely silence the camera. Camera sounds may still be audible, for example during autofocus or aperture adjustment, in the latter case most noticeably at apertures smaller (i.e., at f-numbers higher) than f/5.6.
- The frame advance rate may drop in some circumstances.
- Long-exposure noise reduction is disabled.
- Optional flash units will not fire.
- Silent mode mutes the electronic shutter and beep speaker and dampens other camera sounds, but does not absolve photographers of the need to respect their subjects' privacy and image rights.

Tip: The Standby Timer

Even when **[ON]** is selected for **[Silent mode]**, a sound will be produced when the standby timer is activated or expires. To mute the standby timer, select **[No limit]** for Custom Setting c3 **[Power off delay]** > **[Standby timer]**.

Touch Controls

MENU button →  setup menu

Adjust settings for monitor touch controls.

Enable/Disable Touch Controls

Enable or disable touch controls. Select [**Playback only**] to enable touch controls in playback mode only.

Glove Mode

Selecting [**ON**] raises the sensitivity of the touch screen, making it easier to use while wearing gloves.

HDMI

MENU button ➡️ setup menu

Adjust settings for connection to HDMI devices ([📖 297](#)).

USB Connection Priority

MENU button ➡  setup menu

Choose the function assigned priority when the camera is connected to a computer via USB.

Option	Description
[Upload]	The monitor remains blank while the camera is connected to a computer. The monitor turns on when the shutter-release button is pressed halfway but upload speeds may drop.
[Shooting]	The monitor remains on while the camera is connected to a computer. Upload speeds may drop.

Location Data (Built-In)

MENU button →  setup menu

Adjust settings for use with the camera's built-in GNSS receiver. For more information, see "Location Data" ([📖 193](#)).

Wireless Remote (WR) Options

MENU button →  setup menu

Adjust status LED and link mode settings for optional WR-R11a and WR-R10 wireless remote controllers. You can also choose a link mode for connection to optional radio-controlled flash units that support Advanced Wireless Lighting.

WR-R10 Wireless Remote Controllers







- A WR-A10 adapter is required when using the WR-R10.
 - Be sure the firmware for the WR-R10 has been updated to the latest version (version 3.0 or later). For information on firmware updates, see the Nikon website for your area.
-

LED Lamp

Enable or disable the status LEDs on the WR-R11a or WR-R10 wireless remote controller mounted on the camera. For more information, see the documentation supplied with the wireless remote controller.

Link Mode

Choose a link mode for WR-R11a or WR-R10 wireless remote controllers mounted on other cameras or radio-controlled flash units that support Advanced Wireless Lighting. Be sure that the same mode is selected for the other devices.













Option	Description
[Pairing]	<p>The camera connects only to devices with which it has previously been paired. Press the pairing button on the wireless remote controller connected to the camera to pair it with other devices.</p> <ul style="list-style-type: none">• As camera will not communicate with devices with which it has not been paired, this option can be used to prevent signal interference from other devices in the vicinity.• Given that each device must be paired separately, however, PIN is recommended when connecting to a large number of devices.
[PIN]	<p>Communication is shared among all devices with the same four-digit PIN. Enter a four-digit PIN of your choosing. Press  or  to highlight digits and press  or  to change. Press  to enter and display the selected PIN.</p>  <ul style="list-style-type: none">• This option is a good choice for photography featuring a large number of remote devices.• If there are multiple cameras present that share the same PIN, the flash units will be under the sole control of the camera that connects first, preventing all other cameras from connecting (the LEDs on the wireless remote controllers connected to the affected cameras will blink).

- Regardless of the option selected for **[Link mode]**, signals from paired wireless remote controllers will always be received by the WR-R11a or WR-R10. Users of the WR-1 wireless remote controller will need to select pairing as the WR-1 link mode.

Assign Remote (WR) Fn Button

MENU button →  setup menu

Choose the role played by the **Fn** button on optional wireless remote controllers equipped with an **Fn** button. See Custom Setting f2 [**Custom controls (shooting)**] for more information.

Option	
	[AF-ON]
	[AF lock only]
	[AE lock (Reset on release)]
	[AE lock only]
	[AE/AF lock]
	[FV lock]
	[ Disable/enable]
	[Switch FX/DX]
FLICKER	[Photo flicker reduction]
	[Preview]
	[Recall shooting functions]
HF FLICKER	[High-frequency flicker reduction]
+RAW	[+ RAW]
	[View mode (photo Lv)]
[None]	

Conformity Marking

MENU button →  setup menu



View some of the standards with which the camera complies.

Battery Info

MENU button →  setup menu

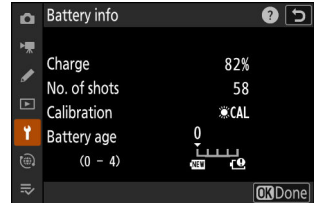
View information on the battery currently inserted in the camera.



Option	Description
[Charge]	The current battery level, expressed as a percentage.
[No. of shots]	The number of pictures taken since the battery was last charged.
[Calibration]	<p>An indicator of whether the battery requires calibration. Calibration ensures the accuracy of the battery level display; after the battery has been charged a certain number of times, [*CAL] will be displayed.</p> <ul style="list-style-type: none">• We recommend that you calibrate the battery when [*CAL] is displayed (book 887).• A [—] indicates that calibration not required.
[Battery age]	<p>A five-level display showing battery age.</p> <ul style="list-style-type: none">• A value of "0" () indicates that battery performance is unimpaired.• A value of "4" () indicates that the battery has reached the end of its charging life. Replace the battery.

✓ **Number of Shots**

[**No. of shots**] shows the number of times the shutter has been released. Note that the camera may sometimes release the shutter without recording a photograph, for example when measuring preset manual white balance.

✓ **Charging Batteries at Low Temperatures**

Batteries in general exhibit a drop in capacity at low ambient temperatures. Even fresh batteries charged at temperatures under about 5 °C (41 °F) may show a temporary increase from "0" to "1" in the value shown for [**Battery age**], but the display will return to normal once the battery has been recharged at a temperature of about 20 °C (68 °F) or higher.

USB Power Delivery

MENU button →  setup menu

Choose whether the supplied charging AC adapter or computers connected via USB can be used to power the camera (USB power delivery). USB power delivery allows the camera to be used while limiting the drain on the battery.

Option	Description
[ON]	The camera draws power from connected devices while on. Connected devices will also supply power when the camera is off if Bluetooth upload is in progress or the memory card access lamp is lit.
[OFF]	The camera does not draw power from connected devices at any time.

- Power will only be supplied to the camera when the battery is inserted.
- A USB power delivery icon appears in the shooting display and the control panel when the camera is powered by an external source.

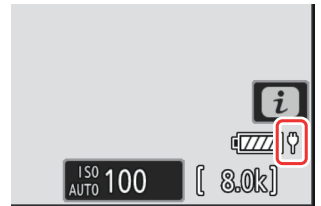

Computer USB Power Delivery

- Before using a computer to supply power to the camera, check that the computer is equipped with a Type C USB connector. Use a UC-E25 USB cable (available separately) to connect the camera to the computer.
- Depending on the model and product specifications, some computers will not supply current to power the camera.

Tip: “Power Delivery” Versus “Charging”

The supply of power for camera operations is referred to as “power delivery”, while the term “charging” is used when power is supplied only to charge the camera battery. The conditions under which the power supplied by external devices is used to power the camera or charge the battery are shown below.

Option selected for [USB power delivery]	Power switch	External power source used for
[ON]	On (standby timer active) ¹	Power delivery
	On (standby timer off)	Charging ²
	Off	Charging ²
[OFF]	On (standby timer active) ¹	—
	On (standby timer off)	Charging ²
	Off	Charging ²

1 Includes instances in which the power switch is in the “OFF” position but Bluetooth upload is in progress or the memory card access lamp is lit.

2 EN-EL18d, EN-EL18c, and EN-EL18b batteries inserted in the camera will charge when the camera is connected to the supplied charging AC adapter or via USB to a computer. Note, however, that batteries with a “4” (🔋) showing for [Battery info] > [Battery age] in the setup menu cannot be charged.

Energy Saving (Photo Mode)

MENU button →  setup menu

In photo mode, the shooting display will dim to save power approximately 15 seconds before the standby timer expires.

Option	Description
[ON]	Enable energy saving. The display refresh rate may drop.
[OFF]	Disable energy saving. Note selecting [OFF] does not stop the shooting display dimming a few seconds before the standby timer expires.

Energy Saving (Photo Mode)

Note that even when [ON] is selected, energy saving will not function:

- if [No limit] is selected for Custom Setting c3 [Power off delay] > [Standby timer] or if the delay selected is less than 30 seconds,
- during zoom,
- while the camera is connected to another device via HDMI,
- while the camera is connected to and exchanging data with a computer via USB, or
- while the camera is connected to an AC adapter.

Slot Empty Release Lock

MENU button →  setup menu

Choose whether the shutter can be released when no memory card is inserted in the camera.

Option		Description
LOCK	[Release locked]	The shutter cannot be released when no memory card is inserted.
OK	[Enable release]	The shutter can be released with no memory card inserted. No pictures will be recorded; during playback, the camera displays [Demo].

Save/Load Menu Settings

MENU button ➔ setup menu

Save current camera menu settings to a memory card. You can also load saved settings, allowing menu settings to be shared among cameras of the same model.

- If two memory cards are inserted, the settings will be saved to the card in Slot 1.

The following settings are saved:

- PHOTO SHOOTING MENU
 - [Shooting menu bank]
 - [Extended menu banks]
 - [File naming]
 - [Role played by card in Slot 2]
 - [Image area]
 - [Image quality]
 - [Image size settings]
 - [RAW recording]
 - [ISO sensitivity settings]
 - [White balance]
 - [Set Picture Control] (Custom Picture Controls are saved as [Auto])
 - [Color space]
 - [Active D-Lighting]
 - [Long exposure NR]
 - [High ISO NR]
 - [Vignette control]
 - [Diffraction compensation]
 - [Auto distortion control]
 - [Photo flicker reduction]
 - [High-frequency flicker reduction]
 - [Metering]
 - [Flash control]
 - [Focus mode]
 - [AF-area mode]
 - [AF subject detection options]
 - [Vibration reduction] (the options available vary with the lens)
 - [Auto bracketing]
- VIDEO RECORDING MENU
 - [Shooting menu bank]
 - [Extended menu banks]
 - [File naming]
 - [Destination]

- [Video file type]
- [Frame size/frame rate]
- [Video quality (N-RAW)]
- [Image area]
- [Extended oversampling]
- [ISO sensitivity settings]
- [White balance]
- [Set Picture Control] (Custom Picture Controls are saved as [Auto])
- [HLG quality]
- [Active D-Lighting]
- [High ISO NR]
- [Vignette control]
- [Diffraction compensation]
- [Auto distortion control]
- [Video flicker reduction]
- [High-frequency flicker reduction]
- [Metering]
- [Focus mode]
- [AF-area mode]
- [AF subject detection options]
- [Vibration reduction] (the options available vary with the lens)
- [Electronic VR]
- [Microphone sensitivity]
- [Attenuator]
- [Frequency response]
- [Wind noise reduction]
- [Mic jack plug-in power]
- [Headphone volume]
- [Timecode] (excepting [Timecode origin])
- [External rec. cntrl (HDMI)]
- [Hi-Res Zoom]
- CUSTOM SETTINGS MENU: All items
- PLAYBACK MENU
 - [Playback display options]
 - [Delete pictures from both slots]
 - [Dual-format recording PB slot]
 - [Filtered playback criteria]
 - [Series playback]
 - [Picture review]
 - [After delete]
 - [After burst, show]
 - [Auto-rotate pictures]
- SETUP MENU

- [Language]
- [Time zone and date] (excepting [Date and time])
- [Finder display size (photo Lv)]
- [Limit monitor mode selection]
- [Auto rotate info display]
- [Non-CPU lens data]
- [Save focus position]
- [Auto temperature cutout]
- [Sensor shield behavior at power off]
- [Clean image sensor]
- [Image comment]
- [Copyright information]
- [IPTC]
- [Voice memo options]
- [Camera sounds]
- [Silent mode]
- [Touch controls]
- [HDMI]
- [USB connection priority]
- [Location data (built-in)] (excepting [Position], [Record location data], and [Create log])
- [Wireless remote (WR) options]
- [Assign remote (WR) Fn button]
- [USB power delivery]
- [Energy saving (photo mode)]
- [Slot empty release lock]
- MY MENU
 - The current contents of "My Menu"
 - [Choose tab]
- RECENT SETTINGS
 - The current contents of the recent settings menu (up to 20 items)
 - [Choose tab]

Save Menu Settings

Save settings to a memory card. If the card is full, an error will be displayed and settings will not be saved. Saved settings can only be used with other cameras of the same model.

Load Menu Settings

Load saved settings from a memory card. Note that [**Load menu settings**] is available only when a memory card containing saved settings is inserted.

Caution: Saved Settings

Settings are saved to files named "NCSET****", where "****" is an identifier that varies from camera to camera. The camera will not be able to load settings if the file name is changed.

Reset All Settings

MENU button →  setup menu

Reset all settings except **[Language]** and **[Time zone and date]** to their default values. Copyright information and other user-generated entries are also reset. Once reset, settings cannot be restored.

We recommend that you save settings using the **[Save/load menu settings]** item in the setup menu before performing a reset.

Firmware Version

MENU button ➡  setup menu

View the current camera firmware version. Firmware updates can be performed if the memory card contains a new version of the camera firmware.

Tip: Firmware Updates

Updates can be performed using a computer or smart device.

- **Computer:** Check the Nikon Download Center for new versions of the camera firmware. For more information, see the firmware download page.
 - **Smart device:** If the smart device has been paired with the camera using the SnapBridge app, the app will automatically notify you when updates become available, and you can then download the update to the camera memory card via the smart device. For more information, see the SnapBridge app's online help. SnapBridge may not display the notification at the same time that updates are made available on the Nikon Download Center.
-

The Network Menu: Network Connections

Network Menu

To view the network menu, select the  tab in the camera menus.

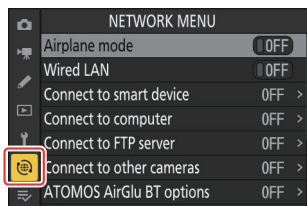

The options in the network menu are listed below, together with their default settings.

- **[Airplane mode]:** OFF
- **[Wired LAN]:** OFF
- **[Connect to smart device]**
 - **[Pairing (Bluetooth)]**
 - **[Bluetooth connection]:** OFF
 - **[Select pictures for upload]**
 - **[Auto select for upload]:** ON
 - **[Wi-Fi connection]:** —
 - **[Upload while off]:** ON
 - **[Location data (smart device)]:** —
- **[Connect to computer]**
 - **[Network settings]:** —
 - **[Connection type]:** Picture transfer
 - **[Options]**
 - **[Auto upload]:** OFF
 - **[Delete after upload]:** OFF
 - **[Upload RAW + JPEG as]:** RAW + JPEG
 - **[JPEG+JPEG slot selection]:** Slot 1
 - **[Upload RAW video as]:** RAW video + MP4
 - **[Upload folder]:** —
 - **[Deselect all?]:** —
- **[Connect to FTP server]**
 - **[Network settings]:** —
 - **[Options]**
 - **[Auto upload]:** OFF

- **[Delete after upload]**: OFF
- **[Upload RAW + JPEG as]**: RAW + JPEG
- **[JPEG+JPEG slot selection]**: Slot 1
- **[Upload RAW video as]**: RAW video + MP4
- **[Overwrite if same name]**: OFF
- **[Protect if marked for upload]**: OFF
- **[Upload marking]**: OFF
- **[Upload folder]**: —
- **[Deselect all?]**: —
- **[Manage root certificate]**: —
- **[Connect to other cameras]**
 - **[Synchronized release]**: ON
 - **[Network settings]**: —
 - **[Group name]**: —
 - **[Master/remote]**: Master camera
 - **[Remote camera list]**: —
 - **[Synchronize date and time]**: —
- **[ATOMOS AirGlu BT options]**
 - **[Connect to ATOMOS AirGlu BT]**: OFF
 - **[Save ATOMOS AirGlu BT pairing info]**: —
 - **[Delete ATOMOS AirGlu BT pairing info]**: —
 - **[Camera]**: NCZ9
- **[USB]**: MTP/PTP
- **[Start via LAN]**: OFF
- **[Router frequency band]**: (Default varies with country of purchase)
- **[MAC address]**: —

Airplane Mode

MENU button →  network menu

Select **[ON]** to disable the camera's built-in Bluetooth and Wi-Fi functions.

Wired LAN

MENU button →  network menu

Select **[ON]** to connect to Ethernet networks. Connect an Ethernet cable to the camera.

Connect to Smart Device

MENU button →  network menu

Connect to smartphones or tablets (smart devices) via Bluetooth or Wi-Fi.

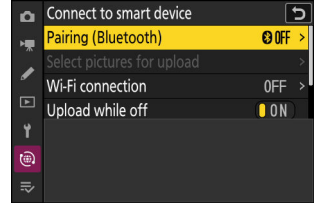

Pairing (Bluetooth)

Pair with or connect to smart devices using Bluetooth.

Option	Description
[Start pairing]	Pair the camera with a smart device (book 306).
[Paired devices]	List paired smart devices. To connect, select a device from the list.
[Bluetooth connection]	Select [ON] to enable Bluetooth.

Select Pictures for Upload

Select pictures for upload to a smart device. You can also opt to upload pictures as they are taken.

Option	Description
[Auto select for upload]	Select [ON] to mark pictures for upload as they are taken. Photos are uploaded in JPEG format at a size of 2 megapixels, even if other upload size and format options are selected with the camera.
[Manually select for upload]	Upload selected pictures. Transfer marking appears on the selected pictures.
[Deselect all]	Cancel upload of all pictures currently selected for transfer.

Wi-Fi connection

Connect to smart devices via Wi-Fi.

Establish Wi-Fi Connection

Initiate a Wi-Fi connection to a smart device.

- The camera SSID and password will be displayed. To connect, select the camera SSID on the smart device and enter the password (🔑 310).
- Once a connection is established, this option will change to [**Close Wi-Fi connection**].
- Use [**Close Wi-Fi connection**] to end the connection when desired.

Wi-Fi Connection Settings

Access the following Wi-Fi settings:

Option	Description
[SSID]	Choose the camera SSID.
[Authentication/encryption]	Choose [OPEN], [WPA2-PSK], [WPA3-SAE], or [WPA2-PSK/WPA3-SAE].
[Password]	Choose the camera password.
[Channel]	Choose a channel. <ul style="list-style-type: none">• Select [Auto] to have the camera choose the channel automatically.• Select [Manual] to choose the channel manually.
[Current settings]	View current Wi-Fi settings.
[Reset connection settings]	Select [Yes] to reset Wi-Fi settings to default values.

Upload While Off

If **[ON]** is selected, upload of pictures to smart devices connected via Bluetooth will continue even when the camera is off.

Location Data (Smart Device)

Display latitude, longitude, altitude, and UTC (Universal Coordinated Time) data downloaded from a smart device. Note that the camera may be unable to download or display location data from smart devices depending on the version of the device operating system and/or SnapBridge app used.

Connect to Computer

MENU button →  network menu

Connect to computers via Ethernet or wireless LAN.

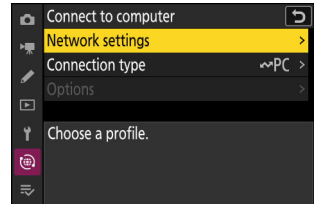



Network Settings

Add camera network profiles. This item can also be used to choose from existing network profiles.

Create Profile

Create new network profiles ([322](#), [335](#)).

- If more than one profile already exists, you can press  to choose a profile and connect to the selected network.
- To edit an existing profile, highlight it and press .

Option	Description
[General]	<ul style="list-style-type: none">• [Profile name]: Rename the profile.• [Password protection]: Select [On] to require that a password be entered before the profile can be changed. To change the password, highlight [On] and press .

Option	Description
[Wireless]	<p>Display connection settings for connection to wireless networks.</p> <ul style="list-style-type: none"> • Infrastructure mode: Adjust settings for connection to a network via a router. <ul style="list-style-type: none"> - [SSID]: Enter the network SSID. - [Channel]: Selected automatically. - [Authentication/encryption]: Select the type of encryption used on the wireless network. - [Password]: Enter the network password. • Access-point mode: Adjust settings for direct wireless connection to the camera. <ul style="list-style-type: none"> - [SSID]: Choose the camera SSID. - [Channel]: Choose [Auto] or [Manual]. - [Authentication/encryption]: Select the type of encryption used on the wireless network. - [Password]: If an option other than [OPEN] is selected for [Authentication/encryption], this item can be used to change the camera password.
[TCP/IP]	<p>Adjust TCP/IP settings for infrastructure connections. An IP address is required.</p> <ul style="list-style-type: none"> • If [ON] is selected for [Obtain automatically], the IP address and sub-net mask for infrastructure mode connections will be acquired via a DHCP server or automatic IP addressing. • Select [OFF] to enter the IP address ([Address]) and sub-net mask ([Mask]) manually.

Copy to/from Card

Share network profiles.

- If two memory cards are inserted, the profiles will be copied to and from the card in Slot 1.

Option	Description
[Copy profile from card]	Copy profiles from the root directory of the memory card to the camera profile list.
[Copy profile to card]	Copy profiles from the camera to the memory card. Highlight a profile and press Ⓜ to copy it to the memory card. <ul style="list-style-type: none">• Password-protected profiles cannot be copied.

End Current Connection

End the connection to the current network.

Connection Type

Choose an operating mode for use when the camera is connected to a network.

Option	Description
[Picture transfer]	Upload photos to a computer as they are taken or upload existing pictures from the camera memory card.
[Camera control]	Use Camera Control Pro 2 (available separately) or free NX Tether software to control the camera and take pictures remotely from a computer.

Options

Adjust upload settings.

Auto Upload

Select **[ON]** to mark new photos for upload as they are taken.

- Upload begins only after the photo has been recorded to the memory card. Be sure a memory card is inserted in the camera.
- Videos will not be uploaded automatically when recording is complete. They must instead be uploaded from the playback display ([📖 251](#)).

Delete After Upload

Select **[ON]** to delete photographs from the camera memory card automatically once upload is complete.

- Files marked for transfer before you selected **[ON]** are not deleted.
- Deletion may be suspended during some camera operations.

Upload RAW + JPEG As

When uploading RAW + JPEG pictures, choose whether to upload both the NEF (RAW) and JPEG files or only the JPEG copy.

- When **[RAW Slot 1 - JPEG Slot 2]** is selected for **[Role played by card in Slot 2]** in the photo shooting menu, the option chosen for **[Upload RAW + JPEG as]** applies only to photos uploaded automatically by selecting **[ON]** for **[Auto upload]**.

JPEG + JPEG Slot Selection

Choose a source slot for auto upload when taking pictures with [JPEG Slot 1 - JPEG Slot 2] selected for [Role played by card in Slot 2] in the photo shooting menu.

Upload RAW Video As

When uploading videos shot with [N-RAW 12-bit (NEV)] or [ProRes RAW HQ 12-bit (MOV)] selected for [Video file type] in the video recording menu, choose whether to upload both the RAW and MP4 files or only the MP4 copy.

Upload Folder

Mark all photos in a selected folder for upload. Marking will be applied to all photos, regardless of whether they have been uploaded previously.

Videos will not be marked for upload. They must instead be uploaded from the playback display.

Deselect All?

Remove upload marking from all pictures. Upload of pictures with an “uploading” icon will immediately be terminated.

Connect to FTP Server

MENU button →  network menu



Connect to FTP servers via Ethernet or wireless LAN.

Network Settings

Add camera network profiles. This item can also be used to choose from existing network profiles.

Create Profile

Create new network profiles ([351](#), [368](#)).

- If more than one profile already exists, you can press  to choose a profile and connect to the selected network.
- To edit an existing profile, highlight it and press .

Option	Description
[General]	<ul style="list-style-type: none">• [Profile name]: Rename the profile.• [Password protection]: Select [On] to require that a password be entered before the profile can be changed. To change the password, highlight [On] and press .
[Wireless]	<p>Display connection settings for connection to wireless networks.</p> <ul style="list-style-type: none">• Infrastructure mode: Adjust settings for connection to a network via a router.<ul style="list-style-type: none">- [SSID]: Enter the network SSID.- [Channel]: Selected automatically.- [Authentication/encryption]: Select the type of encryption used on the wireless network.- [Password]: Enter the network password.• Access-point mode: Adjust settings for direct wireless connection to the camera.<ul style="list-style-type: none">- [SSID]: Choose the camera SSID.- [Channel]: Choose [Auto] or [Manual].- [Authentication/encryption]: Select the type of encryption used on the wireless network.- [Password]: If an option other than [OPEN] is selected for [Authentication/encryption], this item can be used to change the camera password.

Option	Description
[TCP/IP]	<p>Adjust TCP/IP settings for infrastructure connections. An IP address is required.</p> <ul style="list-style-type: none"> • [Obtain automatically]: If [ON] is selected, the IP address and sub-net mask for infrastructure mode connections will be acquired via a DHCP server or automatic IP addressing. Select [OFF] to enter the IP address ([Address]) and sub-net mask ([Mask]) manually. • [Gateway]: Enter the network's default gateway address, if required. • [Domain Name Server (DNS)]: If a DNS is present on the same network as the FTP server, enter its address.
[FTP]	<ul style="list-style-type: none"> • [Server type]: Choose the FTP server type and enter the URL or IP address, destination folder, and port number. An IP address is required. • [PASV mode]: Select [ON] to enable PASV mode. • [Anonymous login]: Select [ON] for anonymous login. This option can only be used with servers that are configured for anonymous login. Select [OFF] to supply a user ID and password. • [Proxy server]: Enable this option as required.

Copy to/from Card

Share network profiles.

- If two memory cards are inserted, the profiles will be copied to and from the card in Slot 1.

Option	Description
[Copy profile from card]	Copy profiles from the root directory of the memory card to the camera profile list.
[Copy profile to card]	Copy profiles from the camera to the memory card. Highlight a profile and press Ⓜ to copy it to the memory card. <ul style="list-style-type: none">• Password-protected profiles cannot be copied.

End Current Connection

End the connection to the current network.

Options

Adjust upload settings.

Auto Upload

Select **[ON]** to mark new photos for upload as they are taken.

- Upload begins only after the photo has been recorded to the memory card. Be sure a memory card is inserted in the camera.
- Videos will not be uploaded automatically when recording is complete. They must instead be uploaded from the playback display ([📖 251](#)).

Delete After Upload

Select **[ON]** to delete photographs from the camera memory card automatically once upload is complete.

- Files marked for transfer before you selected **[ON]** are not deleted.
- Deletion may be suspended during some camera operations.

Upload RAW + JPEG As

When uploading RAW + JPEG pictures, choose whether to upload both the NEF (RAW) and JPEG files or only the JPEG copy.

- When **[RAW Slot 1 - JPEG Slot 2]** is selected for **[Role played by card in Slot 2]** in the photo shooting menu, the option chosen for **[Upload RAW + JPEG as]** applies only to photos uploaded automatically by selecting **[ON]** for **[Auto upload]**.

JPEG + JPEG Slot Selection

Choose a source slot for auto upload when taking pictures with [JPEG Slot 1 - JPEG Slot 2] selected for [Role played by card in Slot 2] in the photo shooting menu.

Upload RAW Video As

When uploading videos shot with [N-RAW 12-bit (NEV)] or [ProRes RAW HQ 12-bit (MOV)] selected for [Video file type] in the video recording menu, choose whether to upload both the RAW and MP4 files or only the MP4 copy.

Overwrite If Same Name

Choose [ON] to overwrite files with duplicate names during upload. Choose [OFF] to add numbers to the names of newly uploaded files as necessary to prevent existing files being overwritten.

Protect If Marked for Upload

Select [ON] to automatically protect files marked for upload. Protection is removed as the files are uploaded.

Upload Marking

Select [ON] to add a timestamp to the pictures on the camera memory card giving the time of upload. The timestamp can be viewed using NX Studio. For more information, see NX Studio's online help.

Upload Folder

Mark all photos in a selected folder for upload. Marking will be applied to all photos, regardless of whether they have been uploaded previously.

Videos will not be marked for upload. They must instead be uploaded from the playback display.

Deselect All?

Remove upload marking from all pictures. Upload of pictures with an “uploading” icon will immediately be terminated.

Manage Root Certificate

Load or manage root certificates used for connection to FTPS servers.

- Contact the network administrator for the FTPS server in question for information on acquiring root certificates.

Option	Description
[Import root certificate]	Import a root certificate to the camera from a memory card. <ul style="list-style-type: none">• The certificate must be in the card's root (top) directory.• The camera can import root certificate files named “ROOT.CER”, “ROOT.CRT”, or “ROOT.PEM”.• Only one root certificate can be stored on the camera at a time. The existing certificate is overwritten when a new certificate is imported.• Connections established using self-signed root certificates may not be trustworthy.
[Delete root certificate]	Delete the current root certificate from the camera.
[View root certificate]	View the camera's current root certificate.
[Connect if authentication fails]	Select [ON] to ignore certain authentication errors.

Connect to Other Cameras

MENU button →  network menu

Connect to other cameras for shutter or clock synchronization.

Synchronized Release



Select **[ON]** to synchronize the shutter release with those of cameras on the same network.

Network Settings

Add camera network profiles. This item can also be used to choose from existing network profiles.

Create Profile

Create new network profiles ([📖 386](#)).

- If more than one profile already exists, you can press  to choose a profile and connect to the selected network.
- To edit an existing profile, highlight it and press .

Option	Description
[General]	<ul style="list-style-type: none">• [Profile name]: Rename the profile. The default profile name is the same as the network SSID.• [Password protection]: Select [On] to require that a password be entered before the profile can be changed. To change the password, highlight [On] and press .
[TCP/IP]	<p>Adjust TCP/IP settings for infrastructure connections. An IP address is required.</p> <ul style="list-style-type: none">• If [ON] is selected for [Obtain automatically], the IP address and sub-net mask for infrastructure mode connections will be acquired via a DHCP server or automatic IP addressing.• Select [OFF] to enter the IP address ([Address]) and sub-net mask ([Mask]) manually.

Copy to/from Card

Share network profiles.

- If two memory cards are inserted, the profiles will be copied to and from the card in Slot 1.

Option	Description
[Copy profile from card]	Copy profiles from the root directory of the memory card to the camera profile list.
[Copy profile to card]	Copy profiles from the camera to the memory card. Highlight a profile and press Ⓜ to copy it to the memory card. <ul style="list-style-type: none">• Password-protected profiles cannot be copied.

End Current Connection

End the connection to the current network.

Group Name

Choose a group for synchronized release. Shutter release is synchronized across the cameras on the network that are in the same group.

Master/Remote

Choose a role for each camera from “master” and “remote”. Pressing the shutter-release button on the master camera releases the shutters on all remote cameras that are both on the same network and in the same group.

Remote Camera List

The master camera lists the remote cameras connected.

Synchronize Date and Time

Set the clocks on the remote cameras to the date and time reported by the master camera ([402](#)).

ATOMOS AirGlu BT Options

MENU button ➡  network menu

Manage wireless Bluetooth connections between the camera and Atomos UltraSync BLUE AirGlu accessories.

- The UltraSync BLUE can be used for simultaneous wireless connections to multiple compatible cameras or audio recorders. Time codes are transmitted to the connected devices from the UltraSync BLUE, synchronizing time codes even across devices from a mix of manufacturers. For information on the maximum number of simultaneous connections, see the Atomos website.

Option	Description
[Connect to ATOMOS AirGlu BT]	Establish a wireless Bluetooth connection to a previously-paired UltraSync BLUE.
[Save ATOMOS AirGlu BT pairing info]	Pair the camera with the UltraSync BLUE. <ul style="list-style-type: none">• The camera name will be displayed in the camera monitor.• Use the controls on the UltraSync BLUE to pair it with the camera. For more information, see the documentation for the UltraSync BLUE.
[Delete ATOMOS AirGlu BT pairing info]	End the wireless connection between the camera and the UltraSync BLUE.
[Camera]	Choose the name under which the camera is listed on the UltraSync BLUE.

- After establishing a wireless connection to the UltraSync BLUE, select **[On]** or **[On (with HDMI output)]** for **[Timecode]** > **[Record timecodes]** in the video recording menu to start receiving time codes. The time codes will appear in the camera shooting display.
- If no time code is received, the shooting display will show "--:--:--" (or "00:00:00:00" when an external device is connected via HDMI). No time codes will be recorded if filming is begun at this stage.

✓ Cautions: Using the UltraSync BLUE

- Time codes will not be recorded if [H.264 8-bit (MP4)] is selected for [Video file type] in the video recording menu.
- The UltraSync BLUE allows users to choose the frame rate. If the value is not a match for that chosen with the camera, time codes will not be recorded or output via HDMI. Match the frame rate for the UltraSync BLUE to the video recording frame rate as follows:

Video recording frame rate	UltraSync BLUE frame rate
120p, 60p, 30p	29.97 fps, 29.97 fps DF
100p, 50p, 25p	25 fps
24p	23.98 fps

- Select 29.97 fps DF for drop-frame recording.
 - See the documentation for the UltraSync BLUE for information on choosing a frame rate.
 - The options selected for [Timecode] > [Count-up method], [Timecode origin], and [Drop frame] in the video recording menu cannot be changed while the camera has a wireless connection to the UltraSync BLUE.
 - If the camera loses the wireless connection to the UltraSync BLUE while filming is in progress, it will continue to record time codes until the end of the current shot, although the time code shown in the shooting display will switch to "--:--:--" about 60 seconds after the connection is lost. The time code will reappear when the wireless connection to the UltraSync BLUE is re-established.
 - The wireless connection to the UltraSync BLUE will end when the camera is turned off or the standby timer expires. We recommend choosing [No limit] for Custom Setting c3 [Power off delay] > [Standby timer].
-

USB

MENU button ➡  network menu

Choose the host device type for USB connections.

- Select **[MTP/PTP]** when connecting to computers or Android devices.
- Select **[iPhone]** only when connecting to iPhones via a third-party USB-C to Lightning cable in order to use NX MobileAir (for information on compatible USB-C to Lightning cables, see the online help for NX MobileAir).

“[iPhone]”

Whether or not the camera is actually connected to an iPhone, selecting **[iPhone]** will disable the features listed below. To access these features, select **[MTP/PTP]**.

- built-in camera network functions
 - powering the camera or charging the battery from a charging AC adapter or via USB
-

Start via LAN

MENU button →  network menu

If **[ON]** is selected, the standby timer can be activated by signals from a computer connected via Ethernet.

Router Frequency Band

MENU button →  network menu

Choose the band for the selected SSID when connecting to a wireless network in infrastructure mode. Select **[2.4 GHz/5 GHz]** to connect to networks operating on either band.

- When the camera searches for networks active in the vicinity, it will list only those operating on the chosen band or bands.
- The band is listed to the left of the network SSID.
- If you select **[2.4 GHz/5 GHz]** when connecting via wireless routers that operate on both bands, the list will include the SSIDs in the band or bands detected by the camera.

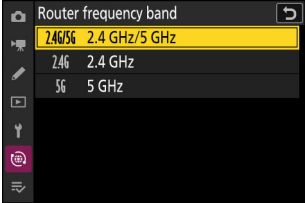

MAC Address

MENU button →  network menu

View the MAC address.

My Menu/Recent Settings

My Menu/Recent Settings

To view **[MY MENU]**, select the  tab in the camera menus.

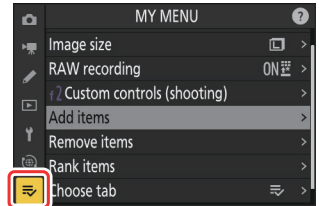

The options in “My Menu” are listed below, together with their default settings.

- **[Add items]**: —
- **[Remove items]**: —
- **[Rank items]**: —
- **[Choose tab]**: MY MENU

My Menu: Creating a Custom Menu

MENU button ➡⇌ my menu

My Menu can be used to create and edit a customized list of up to 20 items from the photo shooting, video recording, Custom Settings, playback, setup, and network menus. Items can be added, deleted, and reordered as described below.

Adding Items to My Menu

1 Select [Add items] in [⇌ MY MENU].

Highlight [Add items] and press ⏏.

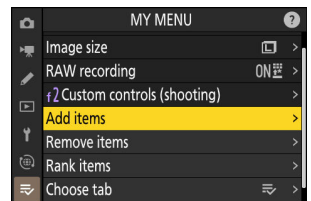

2 Select a menu.

Highlight the name of the menu containing the item you wish to add and press ⏏.

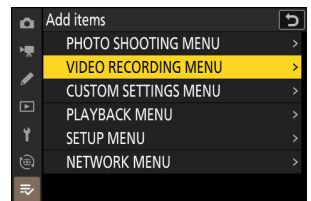

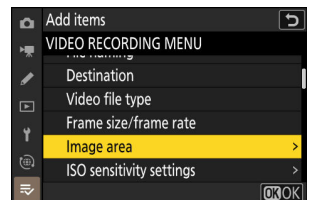

3 Select an item.

Highlight the desired menu item and press ⏏.



4 Position the new item.

Press  or  to position the new item and press  to add it to My Menu.

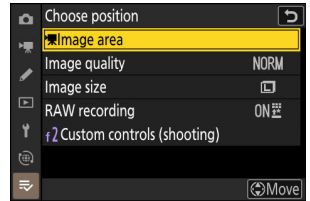

5 Add more items.

- The items currently displayed in My Menu are indicated by a check mark (✓).
- Items indicated by a  icon cannot be selected.
- Repeat Steps 1–4 to select additional items.

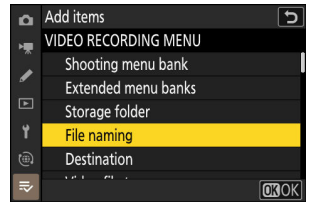



Removing Items from My Menu

1 Select [Remove items] in [≡ MY MENU].



Highlight [Remove items] and press .

2 Select items.

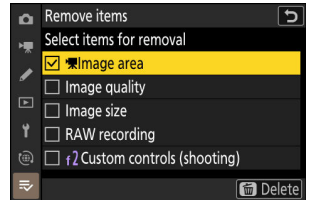
- Highlight items and press  or  to select () or deselect () items.
- Continue until all the items you wish to remove are selected (.



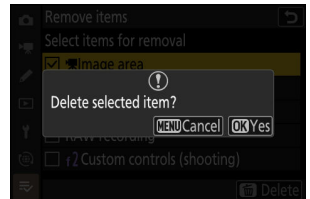

3 Remove the selected items.

Press ; a confirmation dialog will be displayed. Press  to remove the selected items.



✓ Removing Items While in My Menu

Items can also be removed by highlighting them in [≡ MY MENU] and pressing the  button; a confirmation dialog will be displayed. Press  again to remove the selected item.

Reordering Items in My Menu

1 Select [Rank items] in [≡ MY MENU].



Highlight [Rank items] and press .

2 Select an item.

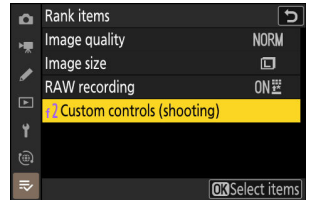
Highlight the item you wish to move and press .



3 Position the item.

- Press  or  to move the item up or down in My Menu and press .
- Repeat Steps 2–3 to reposition additional items.

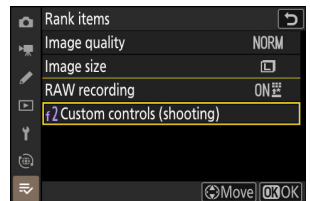

4 Exit to [≡ MY MENU].

Press the **MENU** button to return to [≡ MY MENU].

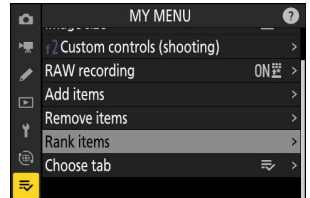

Displaying [RECENT SETTINGS]

1 Select [Choose tab] in [MY MENU].

Highlight [Choose tab] and press .

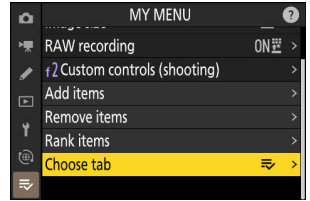

2 Select [RECENT SETTINGS].

- Highlight [RECENT SETTINGS] in the [Choose tab] menu and press .
- The name of the menu will change from [MY MENU] to [RECENT SETTINGS].

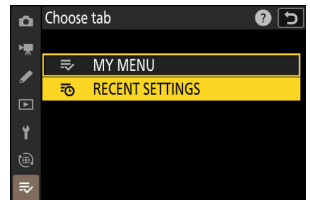

Recent Settings: Accessing Recently-Used Settings

MENU button ➡️ recent settings

How Items Are Added to [RECENT SETTINGS]

Menu items are added to the top of the [RECENT SETTINGS] menu as they are used. The twenty most recently-used settings are listed.

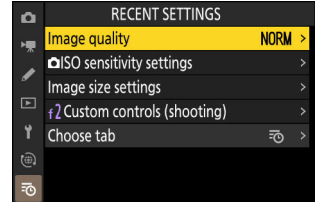

✓ Removing Items from the Recent Settings Menu

To remove an item from the [RECENT SETTINGS] menu, highlight it and press the (trash) button; a confirmation dialog will be displayed. Press (trash) again to remove the selected item.

✓ Displaying My Menu

Selecting [RECENT SETTINGS] > [Choose tab] menu displays the items shown in Step 2 of “Displaying [RECENT SETTINGS]” ([811](#)). Highlight [MY MENU] and press to view My Menu.

Troubleshooting

Before Contacting Customer Support

You may be able to resolve any issues with the camera by following the steps below. Check this list before consulting your retailer or Nikon-authorized service representative.

1 Check the list of common problems.

Common problems and solutions are listed in the following sections:

- “Problems and Solutions” ([📖 815](#))
- “Alerts and Error Messages” ([📖 826](#))



2 Turn the camera off and remove the battery, then wait about a minute, re-insert the battery and turn the camera on.

- ✓ The camera may continue to write data to the memory card after shooting. Wait at least a minute before removing the battery.



3 Search Nikon websites.

- For support information and answers to frequently asked questions, visit the website for your country or region ([📖 36](#)).
- To download the latest firmware for your camera, visit:
<https://downloadcenter.nikonimglib.com/>



4 Consult a Nikon-authorized service representative.

✓ Restoring Default Settings

- Depending on current settings, some menu items and other features may be unavailable. To access menu items that are grayed out or features that are otherwise unavailable, try restoring default settings using the **[Reset all settings]** item in the setup menu.
 - Note, however, that wireless network profiles, copyright information, and other user-generated entries will also be reset. Once reset, settings cannot be restored.
-

Problems and Solutions

Solutions to some common issues are listed below.

Battery/Display

- **The camera is on but does not respond:**

- Wait for recording and other operations to end.
- If the problem persists, turn the camera off.
- If the camera does not turn off, remove and reinsert the battery.
- If you are using an AC adapter, disconnect and reconnect the AC adapter.
 - Any data currently being recorded will be lost.
 - Data that have already been recorded are not affected by removing or disconnecting the power source.

- **The viewfinder or monitor does not turn on:**

- Have you changed the monitor mode? Choose a different monitor mode using the **MON** button.
- Have you limited the choice of monitor modes available using the **[Limit monitor mode selection]** item in the setup menu? Adjust settings as required.
- Dust, lint, or other foreign matter on the eye sensor may prevent it functioning normally. Clean the eye sensor with a blower.

- **The viewfinder is out of focus:**

- Rotate the diopter adjustment control to adjust viewfinder focus.
- If adjusting viewfinder focus does not correct the problem, set the focus mode to **AF-S** and the AF-area mode to single-point AF. Next, select the center focus point, choose a high-contrast subject, and focus using autofocus. With the camera in focus, use the diopter adjustment control to bring the subject into clear focus in the viewfinder.

- **The display in the control panel, viewfinder, or monitor turns off without warning:**

Choose longer delays for Custom Setting c3 **[Power off delay]**.

- **The control panel is unresponsive and dim:**

Control panel response times and brightness vary with temperature.

- **The viewfinder is unresponsive:**

The display refresh rate may drop about 20 seconds before the standby timer turns off. The length of time before the standby timer expires automatically can be selected using Custom Setting c3 **[Power off delay]** > **[Standby timer]**.

Shooting

- **The camera takes time to turn on:**

More time will be needed to find files if the memory card contains large numbers of files or folders.

- **The shutter cannot be released:**

- Is a memory card inserted, and if so, does it have space available?
- If you selected mode **S** after selecting a shutter speed of “**Bulb**” or “**Time**” in mode **M**, choose a different shutter speed.
- Is [**Release locked**] selected for [**Slot empty release lock**] in the setup menu?

- **Burst shooting is unavailable:**

Burst shooting cannot be used in conjunction with HDR.

- **Photos are out of focus:**

- Is the camera in manual focus mode? To enable autofocus, select **AF-S**, **AF-C**, or **AF-F** for focus mode.
- The camera may be unable to focus if:
 - the subject contains lines parallel to the long edge of the frame,
 - the subject lacks contrast,
 - the subject in the focus point contains areas of sharply contrasting brightness,
 - the focus point includes night-time spot lighting or a neon sign or other light source that changes in brightness,
 - flicker or banding appears under fluorescent, mercury-vapor, sodium-vapor, or similar lighting,
 - a cross (star) filter or other special filter is used,
 - the subject appears smaller than the focus point, or
 - the subject is dominated by regular geometric patterns (e.g., blinds or a row of windows in a skyscraper).
- In focus mode **AF-C**, the focus point may flash while the shutter-release button is pressed halfway or the **AF-ON** button is pressed, indicating that the camera is no longer able to focus. The focus operation can be resumed by releasing and then pressing the button again.

● **The beep does not sound:**

- Is **[ON]** selected for **[Silent mode]** in the setup menu?
- A beep does not sound when the camera focuses with **AF-C** selected for focus mode.
- Select an option other than **[Off]** for **[Camera sounds]** > **[Beep on/off]** in the setup menu.
- The beep does not sound in video mode.

● **The full range of shutter speeds is not available:**

Using a flash restricts the range of shutter speeds available. Flash sync speed can be set to values of $\frac{1}{200}$ – $\frac{1}{60}$ s using Custom Setting e1 **[Flash sync speed]**. When using flash units that support auto FP high-speed sync, choose **[1/250 s (Auto FP)]** or **[1/200 s (Auto FP)]** for shutter speeds as fast as $\frac{1}{8000}$ s.

● **Focus does not lock when the shutter-release button is pressed halfway:**

When **AF-C** is selected for focus mode, focus can be locked by pressing the center of the sub-selector.

● **Focus-point selection is not available:**

Focus-point selection is not available when **[Auto-area AF]** is selected for AF-area mode.

● **Focus-mode selection is not available.**

Select **[No restrictions]** for Custom Settings a9 and g5 **[Focus mode restrictions]**.

● **The camera is slow to record photos:**

Is **[ON]** selected for **[Long exposure NR]** in the photo shooting menu?

● **Photographs and videos do not appear to have the same exposure as the preview shown in the display:**

- The effects of changes to settings that affect exposure and color are not visible in the display when [**Adjust for ease of viewing**] is selected for Custom Setting d9 [**View mode (photo Lv)**]. Note that even when [**Show effects of settings**] is selected for Custom Setting d9, display brightness will be adjusted for ease of viewing (per [**Adjust for ease of viewing**]) in mode **M** when a flash unit is attached.
- Note that changes to [**Monitor brightness**] and [**Viewfinder brightness**] have no effect on pictures recorded with the camera.

● **Flicker or banding appears in video mode:**

Select [**Video flicker reduction**] in the video recording menu and choose an option that matches the frequency of the local AC power supply.

● **Bright regions or bands appear:**

Bright regions or bands may occur if the subject is lit by a flashing sign, flash, or other light source with brief duration.

● **Smudges appear in photographs:**

- Are there smudges on the front or rear (mount-side) lens elements?
- Is there foreign matter on the image sensor? Perform image sensor cleaning.

● **Pictures are affected by noticeable ghosting or flare:**

You may notice ghosting or flare in shots that include the sun or other bright light sources. These effects can be mitigated by attaching a lens hood or by composing shots with bright light sources well out of the frame. You can also try such techniques as removing lens filters or choosing a different shutter speed.

● **Bokeh is irregular:**

With fast shutter speeds and/or fast lenses, you may notice irregularities in how *bokeh* is shaped. The effect can be mitigated by choosing slower shutter speeds and/or higher f-numbers.

● **Shooting ends unexpectedly or does not start:**

- Shooting may end automatically to prevent the camera overheating, for example if:
 - the ambient temperature is high,
 - the camera has been used for extended periods to record videos, or
 - the camera has been used in continuous release modes for extended periods.
- If pictures cannot be taken because the camera is running hot, turn the camera off and wait for it to cool before trying to take pictures again. Note that the camera may feel warm to the touch, but this does not indicate a malfunction.

● **Image artifacts appear in the display during shooting:**

- To reduce noise, adjust settings such as ISO sensitivity, shutter speed, or Active D-Lighting.
- At high ISO sensitivities, noise may become more noticeable in long exposures or in pictures recorded when the camera temperature is elevated.
- Randomly-spaced bright pixels, fog, or bright spots may arise as a result of increases in the temperature of the camera's internal circuits. Turn the camera off when it is not in use.
- Randomly-spaced bright pixels, fog, lines or unexpected colors may appear if you press the  button to zoom in on the view through the lens during shooting.
- Note that the distribution of noise in the display may differ from that in the final picture.
- This issue can sometimes be addressed by checking and optimizing the image sensor. Perform pixel mapping using **[Pixel mapping]** in the setup menu.

● **The camera cannot measure a value for preset manual white balance:**

The subject is too dark or too bright.

● **Certain pictures cannot be selected as sources for preset manual white balance:**

Pictures created with cameras of other types cannot serve as sources for preset manual white balance.

● **White balance (WB) bracketing is unavailable:**

- White balance bracketing is not available when an NEF (RAW) or RAW + JPEG option is selected for image quality.
- White balance bracketing cannot be used in multiple exposure and HDR overlay modes.

- **The effects of [Set Picture Control] differ from picture to picture:**

[Auto] is selected for [Set Picture Control] or as the basis for a custom Picture Control created using [Manage Picture Control], or [A] (auto) is selected for [Quick sharp], [Contrast], or [Saturation]. For consistent results over a series of photographs, choose a setting other than [A] (auto).

- **The option selected for metering cannot be changed:**

The option selected for metering cannot be changed during exposure lock.

- **Exposure compensation is not available:**

Changes to exposure compensation in mode **M** apply only to the exposure indicator and have no effect on shutter speed or aperture.

- **Uneven shading appears in long exposures:**

Uneven shading may appear in long exposures shot at shutter speeds of “Bulb” or “Time”. The effect can be mitigated by selecting [ON] for [Long exposure NR] in the photo shooting menu.

- **The AF-assist illuminator does not light:**

- Is [OFF] selected for Custom Setting a12 [Built-in AF-assist illuminator]?
- The illuminator does not light in video mode.
- The illuminator does not light when **AF-C** or **MF** is selected for focus mode.

- **Sound is not recorded with videos:**

- Is [Microphone off] selected for [Microphone sensitivity] in the video recording menu?
- Was the video recorded with [Microphone sensitivity] > [Manual] chosen in the video recording menu and a low sensitivity selected?

Playback

- **NEF (RAW) pictures are not visible during playback:**

The camera displays only the JPEG copies of pictures taken with [RAW + JPEG fine★], [RAW + JPEG fine], [RAW + JPEG normal★], [RAW + JPEG normal], [RAW + JPEG basic★], or [RAW + JPEG basic] selected for [Image quality].

- **Pictures taken with other cameras are not displayed:**

Pictures recorded with other types of camera may not display correctly.

- **Not all photos are visible during playback:**

Select [All] for [Playback folder] in the playback menu.

- **“Tall” (portrait) orientation photos are displayed in “wide” (landscape) orientation:**

- Is [OFF] selected for [Auto-rotate pictures] in the playback menu?
- Auto picture rotation is not available during picture review.
- Camera orientation may not be correctly recorded in photos taken with the camera pointing up or down.

- **Pictures cannot be deleted:**

Are the pictures protected?

- **Pictures cannot be retouched:**

- The pictures cannot be further edited with this camera.
- There is insufficient space on the memory card to record the retouched copy.

- **The camera displays the message, “[Folder contains no pictures.]”:**

Select [All] for [Playback folder] in the playback menu.

● **NEF (RAW) pictures cannot be printed:**

- Print JPEG copies of the pictures created using a tool such as the **[RAW processing (current picture)]** or **[RAW processing (multiple pictures)]** items in the playback **i** menu.
- Copy the pictures to a computer and print them using NX Studio or other software that supports the NEF (RAW) format.

● **Pictures are not displayed on HDMI devices:**

Confirm that an HDMI cable is correctly connected.

● **Output to HDMI devices does not function as expected:**

- Confirm that an HDMI cable is correctly connected.
- Is **[ON]** selected for **[External rec. cntrl (HDMI)]** in the video recording menu?
- Pictures may display correctly if default settings are restored using the **[Reset all settings]** item in the setup menu.

● **The Image Dust Off option in NX Studio does not have desired effect:**

Image sensor cleaning changes the position of dust on the image sensor and will not have the desired effect if:

- Image Dust Off reference data recorded after image sensor cleaning is performed are used with photographs taken before image sensor cleaning is performed, or
- Image Dust Off reference data recorded before image sensor cleaning is performed are used with photographs taken after image sensor cleaning is performed.

● **The effects of [Set Picture Control], [Active D-Lighting], or [Vignette control] are not visible:**

In the case of NEF (RAW) pictures, the effects can only be viewed using Nikon software. View NEF (RAW) pictures using NX Studio.

● **Pictures cannot be copied to a computer:**

Depending on the operating system, you may be unable to upload pictures when the camera is connected to a computer. Copy pictures from the memory card to a computer using a card reader or other device.

Bluetooth and Wi-Fi (Wireless Networks)

• **Smart devices do not display the camera SSID (network name):**

- Navigate to the network menu and confirm both that **[OFF]** is selected for **[Airplane mode]** and that **[ON]** is selected for **[Connect to smart device] > [Pairing (Bluetooth)] > [Bluetooth connection]**.
- Confirm that **[Connect to smart device] > [Wi-Fi connection]** is enabled in the network menu.
- Try disabling and re-enabling wireless network features on the smart device.

• **The camera cannot connect to printers and other wireless devices:**

The camera cannot establish wireless connections with devices other than smartphones, tablets, and computers.

• **Pictures cannot be uploaded to smart devices via auto upload:**

- If **[Foreground]** is selected for **[Auto link] > [Link mode]** in the SnapBridge  tab, pictures will not be uploaded to the smart device automatically while the SnapBridge app is running in the background. Pictures will only be uploaded when the SnapBridge app is displayed (running in the foreground) on the smart device.
- Check that the camera is paired with the smart device.
- Check that the camera and smart device are configured for connection via Bluetooth.

• **The camera cannot download location data from the smart device:**

- The camera may be unable to download or display location data from smart devices depending on the version of the operating system and/or SnapBridge app used.
- If **[Foreground]** is selected for **[Auto link] > [Link mode]** in the SnapBridge  tab, location data will not be downloaded to the camera. Instead, they will be embedded in photographs after they are uploaded to the smart device.

Miscellaneous

- **The date of recording is not correct:**

Is the camera clock set correctly? The clock is less accurate than most watches and household clocks; check it regularly against more accurate timepieces and reset as necessary.

- **Menu items cannot be selected:**

Some items are not available at certain combinations of settings.

Alerts and Error Messages

This section lists the alerts and error messages that appear in the control panel and camera display.

Alerts

The following alerts appear in the control panel and camera display:

Alert		Problem/solution
Camera display	Control panel	
		Low battery. Ready spare battery.
	F --	Lens is not correctly attached. <ul style="list-style-type: none">• Ensure that the lens is correctly attached.• Ensure that retractable lenses are extended.• This indicator is also displayed when a non-CPU lens is attached via a mount adapter, but in this case no action need be taken.
	Bulb (flashes)	“Bulb” selected in mode S. <ul style="list-style-type: none">• Change shutter speed.• Select mode M.
	Time (flashes)	“Time” selected in mode S. <ul style="list-style-type: none">• Change shutter speed.• Select mode M.
	Busy (flashes)	Processing in progress. Wait until processing is complete.

Alert		Problem/solution
Camera display	Control panel	
(Exposure indicators and shutter speed or aperture display flash)		<p>Subject too bright; limits of camera exposure metering system exceeded.</p> <ul style="list-style-type: none"> • Lower ISO sensitivity. • Mode P: Use third-party ND (neutral density) filter (filter can also be used if alert is still displayed after following settings are adjusted in mode S or A). • Mode S: Choose faster shutter speed. • Mode A: Choose smaller aperture (higher f-number).
		<p>Subject too dark; limits of camera exposure metering system exceeded.</p> <ul style="list-style-type: none"> • Increase ISO sensitivity. • Mode P: Use optional flash unit (flash can also be used if alert is still displayed after following settings are adjusted in mode S or A). • Mode S: Choose slower shutter speed. • Mode A: Choose wider aperture (lower f-number).
 (flashes)	—	<p>Flash has fired at full power.</p> <p>Photo may be underexposed. Check distance to subject and settings such as aperture, flash range, and ISO sensitivity.</p>
Full (flashes)		<p>Memory insufficient to record further photos.</p> <ul style="list-style-type: none"> • Delete pictures from memory card until there is room for additional pictures to be recorded. Copy pictures you wish to keep to computer or other device before proceeding. • Insert new memory card.
		<p>Camera has run out of file numbers.</p> <ul style="list-style-type: none"> • Delete pictures from memory card until there is room for additional pictures to be recorded. Copy pictures you wish to keep to computer or other device before proceeding. • Insert new memory card.

Alert		Problem/solution
Camera display	Control panel	
<p>Err (flashes)</p>		<p>Camera malfunction. Press shutter-release button again. If error persists or appears frequently, consult Nikon-authorized service representative.</p>

Error Messages

The following error messages may appear in the camera display:

Message		Problem/solution
Camera display	Control panel	
Shutter release disabled. Recharge battery.	—	Battery exhausted. <ul style="list-style-type: none"> • Replace with spare battery. • Charge battery.
This battery is unable to provide data to the camera and cannot be used. For safety, choose a battery designated for use in this camera.	—	Battery info not available. <ul style="list-style-type: none"> • Battery cannot be used. Contact Nikon-authorized service representative. • Battery level is extremely low; charge battery.
	—	Battery cannot supply data to camera. Replace third-party batteries with genuine Nikon batteries.
No memory card.	[–E–]	The memory card is inserted incorrectly or not at all. Check that card is inserted correctly.
Cannot access this memory card. Insert another card.	Card, Err (flashes)	Error accessing memory card. <ul style="list-style-type: none"> • Check that camera supports memory card. • Insert new memory card. • If error persists after card has been repeatedly ejected and reinserted, card may be damaged. Contact retailer or Nikon-authorized service representative.
		Unable to create new folder. Insert new memory card.
This card is not formatted. Format the card.	For (flashes)	Memory card is not correctly formatted. <ul style="list-style-type: none"> • Format memory card. • Replace with correctly-formatted memory card.

Message		Problem/solution
Camera display	Control panel	
FTZ mount adapter firmware version not supported. Upgrade FTZ firmware.	—	Mount adapter firmware out of date. Update to the latest version of the mount adapter firmware. For more information, visit the Nikon website for your country or region.
Recording interrupted. Please wait.	—	Memory card does not support required video write speed. Use card that supports required write speed or change option selected for [Frame size/frame rate] in video recording menu.
The camera is too hot. It cannot be used until it cools. Please wait. Camera will turn itself off.	—	Camera's internal temperature is elevated. Suspend shooting until camera has cooled.
		High battery temperature. Remove battery and wait for it to cool.
Folder contains no pictures.	—	Folder contains no pictures. Insert memory card that contains pictures.
		No pictures in folder selected for playback. Use [Playback folder] item in playback menu to select folder that contains pictures.
Cannot display this file.	—	File has been modified using computer application or does not conform to DCF file standard. Do not overwrite pictures using computer applications.
		File is corrupt. Do not overwrite pictures using computer applications.
Cannot select this file.	—	Selected picture cannot be retouched. Retouch options are available only with pictures taken with or previously retouched on camera.

Message		Problem/solution
Camera display	Control panel	
This video cannot be edited.	—	<p>Selected video cannot be edited.</p> <ul style="list-style-type: none"> • Videos created with other devices cannot be edited. • Videos under two seconds long cannot be edited.
This file cannot be saved to the destination memory card. See the camera manual for details.	—	<p>Files 4 GB or larger can only be saved to memory cards formatted for exFAT. They will not be saved to cards in other formats such as FAT32.</p> <p>Use a memory card with a capacity over 64 GB formatted in the camera or keep file size to under 4 GB.</p>

Technical Notes

Compatible Lenses and Accessories

The camera can be used with all Z mount lenses.

NIKKOR Z 24–70mm f/4 S

Confirm that the lens name includes “NIKKOR Z”.

- Be sure to update to the latest versions of the camera and lens firmware. With earlier versions, some functions may not be available or the camera may fail to correctly detect the lens. The latest firmware is available from the Nikon Download Center.

Tip: Compatible F Mount Lenses

F mount lenses can be mounted on Z mount cameras using an FTZ II/FTZ mount adapter.

- Some features may not be available depending on the lens used.

Information on the F mount lenses that can be used with Z mount cameras and on any restrictions that may apply can be found in *Compatible F Mount Lenses*, available from the Nikon Download Center:

<https://downloadcenter.nikonimglib.com/>

Camera Displays

The displays show information on current settings. Other icons or warnings may occasionally be displayed, for example when settings are changed.

The Monitor

Photo Mode

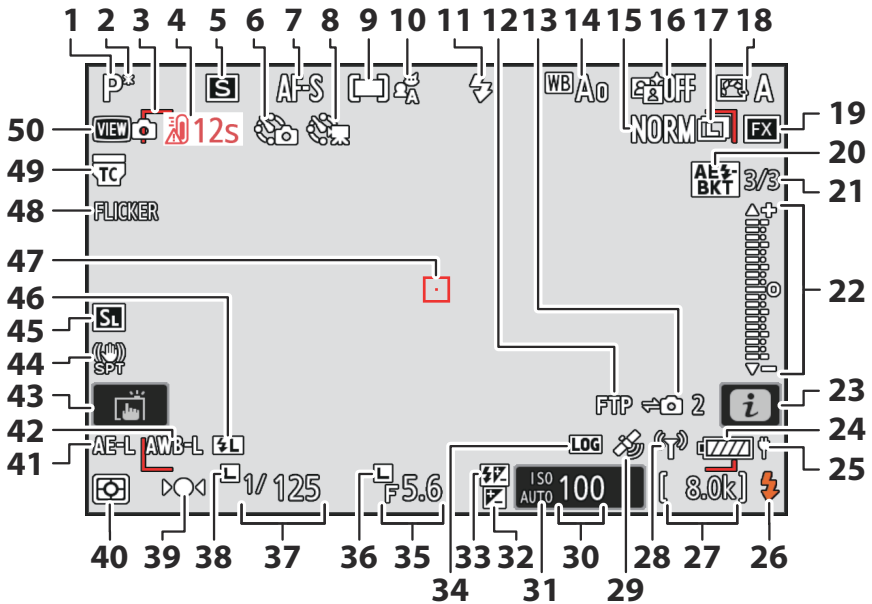

- 1** Shooting mode ([📖 127](#))
- 2** Flexible program indicator ([📖 128](#))
- 3** AF-area brackets ([📖 112](#))
- 4** Temperature warning ([📖 741](#))
- 5** Release mode ([📖 139](#))
- 6** Interval timer indicator ([📖 492](#))
 - ⊕ icon ([📖 92](#))
 - “No memory card” indicator ([📖 86](#), [📖 835](#))
 - Memory card high-temperature warning ([📖 87](#))
- 7** Focus mode ([📖 110](#))
- 8** Time-lapse video recording indicator ([📖 503](#))
- 9** AF-area mode ([📖 112](#))
- 10** Subject detection ([📖 116](#))
- 11** Flash mode ([📖 409](#))
- 12** FTP connection status ([📖 351](#), [📖 368](#))
- 13** Remote camera connection status ([📖 386](#))
- 14** White balance ([📖 151](#))
- 15** Image quality ([📖 106](#))
- 16** Active D-Lighting ([📖 459](#))
- 17** Image size ([📖 108](#))
- 18** Picture Control ([📖 183](#))
- 19** Image area ([📖 104](#))
- 20** Exposure and flash bracketing indicator ([📖 171](#))
 - WB bracketing indicator ([📖 176](#))
 - ADL bracketing indicator ([📖 179](#))
 - HDR indicator ([📖 488](#))
 - Multiple exposure indicator ([📖 481](#))
- 21** Pre-Release Capture ()
 - Number of shots in exposure and flash bracketing sequence ([📖 171](#))
 - Number of shots in WB bracketing sequence ([📖 176](#))
 - Number of shots in ADL bracketing sequence ([📖 179](#))
 - HDR strength ([📖 488](#))
 - Number of shots in multiple exposure ([📖 481](#))
- 22** Exposure indicator
 - Exposure ([📖 130](#))
 - Exposure compensation ([📖 137](#))
 - Auto bracketing ([📖 170](#))
- 23** *z* icon ([📖 72](#))
- 24** Battery indicator ([📖 85](#))
- 25** USB power delivery ([📖 769](#))
- 26** Flash-ready indicator ([📖 404](#))
- 27** Number of exposures remaining ([📖 86](#), [📖 921](#))
 - Camera control mode ([📖 891](#))
- 28** Wi-Fi connection indicator ([📖 310](#), [📖 322](#), [📖 351](#))
 - Bluetooth connection indicator ([📖 783](#))
 - Airplane mode ([📖 781](#))
- 29** Satellite signal indicator ([📖 194](#))
- 30** ISO sensitivity ([📖 147](#))
- 31** ISO sensitivity indicator ([📖 147](#))
 - Auto ISO sensitivity indicator ([📖 149](#))
- 32** Exposure compensation indicator ([📖 137](#))
- 33** Flash compensation indicator ([📖 411](#))
- 34** Track log indicator ([📖 193](#))
- 35** Aperture ([📖 128](#), [📖 129](#))
- 36** Aperture lock icon ([📖 660](#))
- 37** Shutter speed ([📖 128](#), [📖 129](#))
- 38** Shutter speed lock icon ([📖 660](#))
- 39** Focus indicator ([📖 124](#))
- 40** Metering ([📖 470](#))
- 41** Autoexposure (AE) lock ([📖 135](#))
- 42** Auto white-balance (AWB) lock ([📖 637](#))
- 43** Touch shooting ([📖 59](#), [📖 120](#))
- 44** Vibration reduction indicator ([📖 477](#))
- 45** Silent mode ([📖 758](#))
- 46** FV lock indicator ([📖 412](#))
- 47** Focus point ([📖 119](#))
- 48** Flicker detection ([📖 466](#))
- 49** “Lens built-in teleconverter enabled” indicator
- 50** View mode ([📖 608](#))

✔ **Temperature Warnings**

- If the camera temperature becomes elevated, a temperature warning and count-down timer will be displayed. When the timer reaches zero, the shooting display will turn off.
- The temperature at which the count-down timer starts can be selected from **[Standard]** and **[High]** using **[Auto temperature cutout]** in the setup menu.
- The timer turns red when the thirty second mark is reached. In some cases, the timer may be displayed immediately after the camera is turned on.

✔ **High-Temperature Warnings**

Increases in the camera's internal temperature or the temperature of memory cards may be accompanied by high-temperature warnings in the shooting display. Wait for the camera to cool and the warnings to clear from the display before handling the camera, battery, or memory cards.

✔ **No Memory Card Inserted**

If no memory card is inserted, a "no memory card" indicator will appear in the shooting display and **[-E-]** will appear in both the control panel and the shooting display.

The Information Display

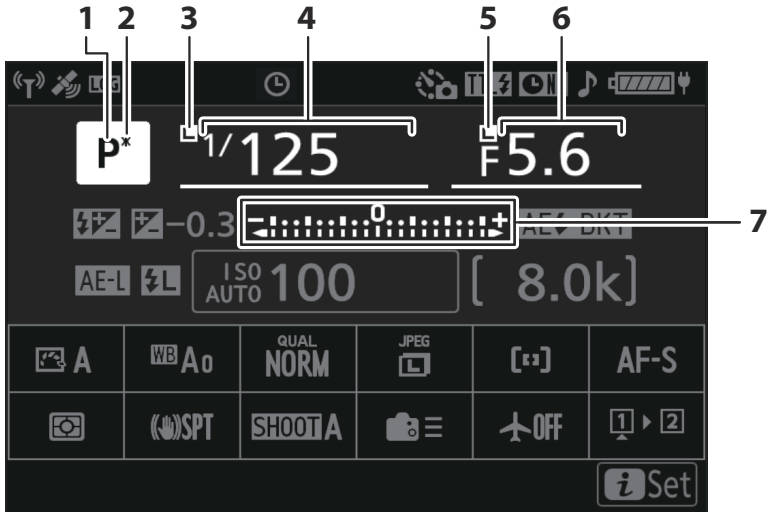

- 1 Shooting mode ([127](#))
- 2 Flexible program indicator ([128](#))
- 3 Shutter speed lock icon ([660](#))
- 4 Shutter speed ([128](#), [129](#))
- 5 Aperture lock icon ([660](#))
- 6 Aperture ([128](#), [129](#))
- 7 Exposure indicator
 - Exposure ([130](#))
 - Exposure compensation ([137](#))
 - Auto bracketing ([170](#))

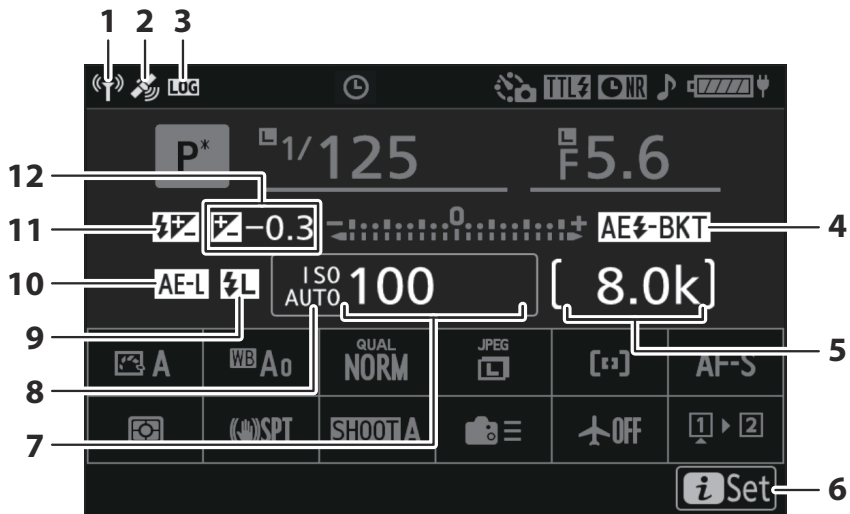

- 1** Wi-Fi connection indicator ([book 310](#),
[book 322](#), [book 351](#))
Bluetooth connection indicator ([book 783](#))
- 2** Satellite signal indicator ([book 194](#))
- 3** Track log indicator ([book 193](#))
- 4** Exposure and flash bracketing indicator ([book 171](#))
WB bracketing indicator ([book 176](#))
ADL bracketing indicator ([book 179](#))
HDR indicator ([book 488](#))
Multiple exposure indicator ([book 481](#))
- 5** Number of exposures remaining ([book 86](#),
[book 921](#))
Camera control mode ([book 891](#))
- 6** *i* icon ([book 72](#))
- 7** ISO sensitivity ([book 147](#))
- 8** ISO sensitivity indicator ([book 147](#))
Auto ISO sensitivity indicator ([book 149](#))
- 9** FV lock indicator ([book 412](#))
- 10** Autoexposure (AE) lock ([book 135](#))
- 11** Flash compensation indicator ([book 411](#))
- 12** Exposure compensation indicator ([book 137](#))
Exposure compensation value ([book 137](#))

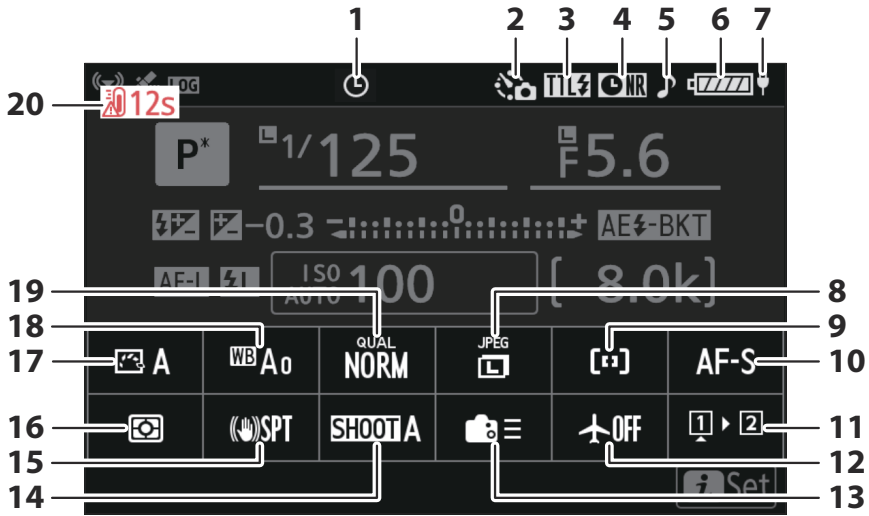

- | | |
|--|---|
| <p>1 ☺ icon (book 92)</p> <p>2 Interval timer indicator (book 492)
Time-lapse video indicator (book 503)</p> <p>3 Flash control mode (book 407)</p> <p>4 Long-exposure noise reduction indicator (book 461)</p> <p>5 “Beep” indicator (book 756)</p> <p>6 Battery indicator (book 85)</p> <p>7 USB power delivery (book 769)</p> <p>8 Image size (book 108)</p> <p>9 AF-area mode/subject detection (book 112)</p> <p>10 Focus mode (book 110)</p> | <p>11 View memory card info (book 636)</p> <p>12 Airplane mode (book 781)</p> <p>13 Custom controls (shooting) (book 637)</p> <p>14 Shooting menu bank (book 439)</p> <p>15 Vibration reduction indicator (book 477)</p> <p>16 Metering (book 470)</p> <p>17 Picture Control (book 183)</p> <p>18 White balance (book 151)</p> <p>19 Image quality (book 106)</p> <p>20 Temperature warning</p> |
|--|---|

Video Mode

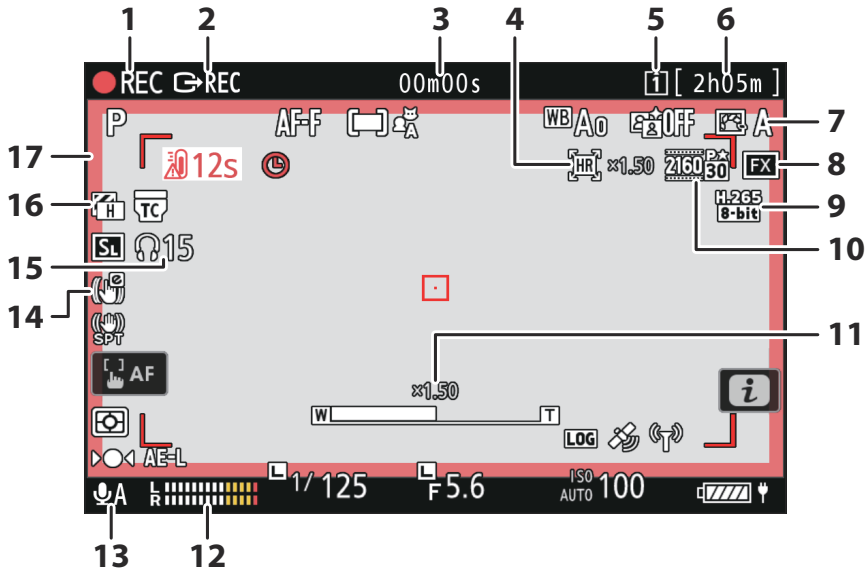

- | | |
|---|--|
| <p>1 Recording indicator (97)
"No video" indicator (98)</p> <p>2 External recording control (297)</p> <p>3 Video recording time (97)
Timecode (558)</p> <p>4 Hi-Res Zoom indicator (223)
Zoom ratio for Hi-Res Zoom (223)</p> <p>5 Destination (528)</p> <p>6 Time remaining (97)</p> <p>7 Picture Control (183)
Tone mode (204)</p> | <p>8 Image area (212)</p> <p>9 Video file type (202)</p> <p>10 Frame size and rate (205)</p> <p>11 Zoom position for Hi-Res Zoom (223)</p> <p>12 Sound level (552)</p> <p>13 Microphone sensitivity (552)</p> <p>14 Electronic VR indicator (551)</p> <p>15 Headphone volume (557)</p> <p>16 Zebra pattern (692)</p> <p>17 Recording indicator (red border; 700)</p> |
|---|--|

The Viewfinder

Photo Mode

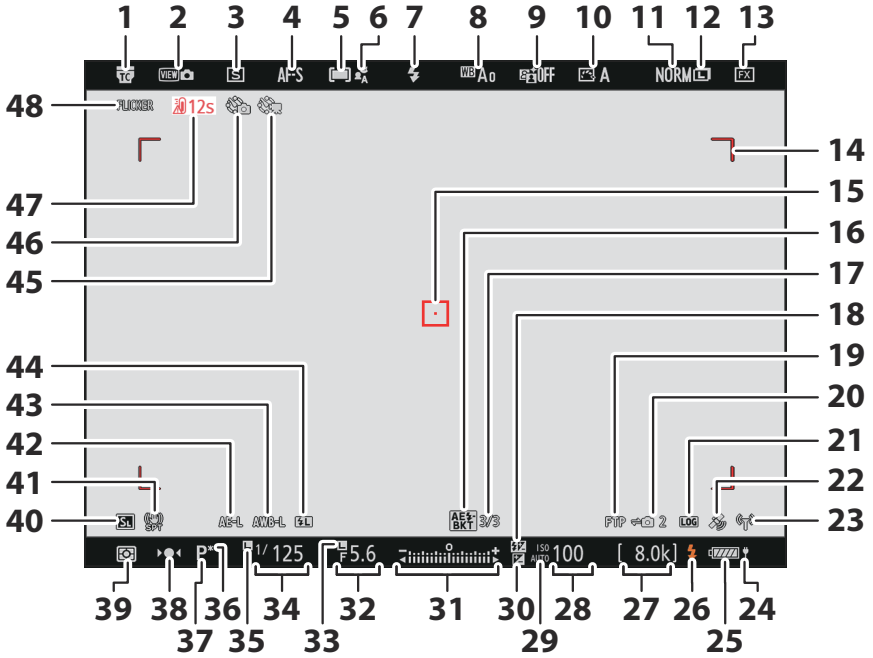

- 1** "Lens built-in teleconverter enabled" indicator
- 2** View mode ([📖 608](#))
- 3** Release mode ([📖 139](#))
- 4** Focus mode ([📖 110](#))
- 5** AF-area mode ([📖 112](#))
- 6** Subject detection ([📖 116](#))
- 7** Flash mode ([📖 409](#))
- 8** White balance ([📖 151](#))
- 9** Active D-Lighting ([📖 459](#))
- 10** Picture Control ([📖 183](#))
- 11** Image quality ([📖 106](#))
- 12** Image size ([📖 108](#))
- 13** Image area ([📖 104](#))
- 14** AF-area brackets ([📖 112](#))
- 15** Focus point ([📖 119](#))
- 16** Exposure and flash bracketing indicator ([📖 171](#))
 - WB bracketing indicator ([📖 176](#))
 - ADL bracketing indicator ([📖 179](#))
 - HDR indicator ([📖 488](#))
 - Multiple exposure indicator ([📖 481](#))
- 17** Number of shots in exposure and flash bracketing sequence ([📖 171](#))
 - Number of shots in WB bracketing sequence ([📖 176](#))
 - Number of shots in ADL bracketing sequence ([📖 179](#))
 - HDR strength ([📖 488](#))
 - Number of shots in multiple exposure ([📖 481](#))
- 18** Flash compensation indicator ([📖 411](#))
- 19** FTP connection status ([📖 351](#), [📖 368](#))
- 20** Remote camera connection status ([📖 386](#))
- 21** Track log indicator ([📖 193](#))
- 22** Satellite signal indicator ([📖 194](#))
- 23** Wi-Fi connection indicator ([📖 310](#), [📖 322](#), [📖 351](#))
 - Bluetooth connection indicator ([📖 783](#))
 - Airplane mode ([📖 781](#))
- 24** USB power delivery ([📖 769](#))
- 25** Battery indicator ([📖 85](#))
- 26** Flash-ready indicator ([📖 404](#))
- 27** Number of exposures remaining ([📖 86](#), [📖 921](#))
 - Camera control mode ([📖 891](#))
- 28** ISO sensitivity ([📖 147](#))
- 29** ISO sensitivity indicator ([📖 147](#))
 - Auto ISO sensitivity indicator ([📖 149](#))
- 30** Exposure compensation indicator ([📖 137](#))
- 31** Exposure indicator
 - Exposure ([📖 130](#))
 - Exposure compensation ([📖 137](#))
 - Auto bracketing ([📖 170](#))
- 32** Aperture ([📖 128](#), [📖 129](#))
- 33** Aperture lock icon ([📖 660](#))
- 34** Shutter speed ([📖 128](#), [📖 129](#))
- 35** Shutter speed lock icon ([📖 660](#))
- 36** Flexible program indicator ([📖 128](#))
- 37** Shooting mode ([📖 127](#))
- 38** Focus indicator ([📖 124](#))
- 39** Metering ([📖 470](#))
- 40** Silent mode ([📖 758](#))
- 41** Vibration reduction indicator ([📖 477](#))
- 42** Autoexposure (AE) lock ([📖 135](#))
- 43** Auto white-balance (AWB) lock ([📖 637](#))
- 44** FV lock indicator ([📖 412](#))
- 45** Time-lapse video indicator ([📖 503](#))
- 46** Interval timer indicator ([📖 492](#))
 - ⊕ icon ([📖 92](#))
 - "No memory card" indicator ([📖 86](#), [📖 835](#))
 - Memory card high-temperature warning ([📖 87](#))
- 47** Temperature warning
- 48** Flicker detection ([📖 466](#))

Video Mode

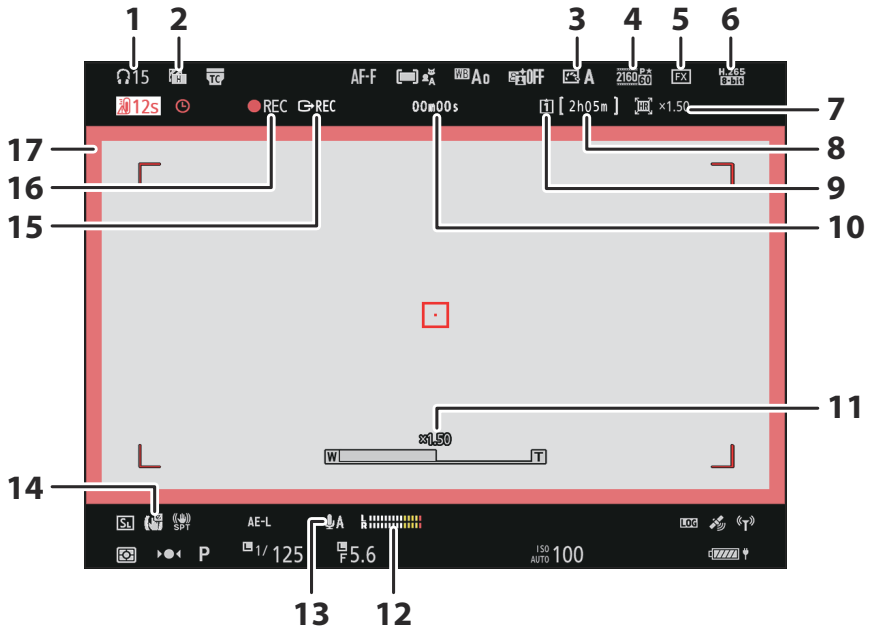

- | | |
|--|---|
| 1 Headphone volume (557) | 9 Destination (528) |
| 2 Zebra pattern (692) | 10 Video recording time (97)
Timecode (558) |
| 3 Picture Control (183)
Tone mode (204) | 11 Zoom position for Hi-Res Zoom (223) |
| 4 Frame size and rate (205) | 12 Sound level (552) |
| 5 Image area (212) | 13 Microphone sensitivity (552) |
| 6 Video file type (202) | 14 Electronic VR indicator (551) |
| 7 Hi-Res Zoom indicator (223)
Zoom ratio for Hi-Res Zoom (223) | 15 External recording control (297) |
| 8 Time remaining (97) | 16 Recording indicator (97)
"No video" indicator (98) |
| | 17 Recording indicator (red border; 700) |

The Control Panel

Photo Mode

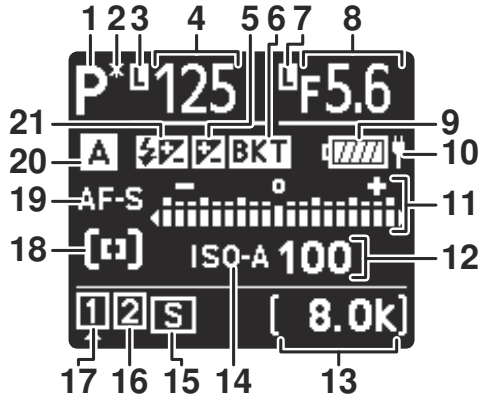

- 1** Shooting mode ([📖 127](#))
- 2** Flexible program indicator ([📖 128](#))
- 3** Shutter speed lock icon ([📖 660](#))
- 4** Shutter speed ([📖 128](#), [📖 129](#))
 - Exposure compensation value ([📖 137](#))
 - Flash compensation value ([📖 411](#))
 - Number of shots in exposure and flash bracketing sequence ([📖 171](#))
 - Number of shots in WB bracketing sequence ([📖 176](#))
 - Intervals remaining in interval timer sequence ([📖 494](#))
 - Shots remaining in focus shift sequence ([📖 515](#))
 - Track log indicator ([📖 193](#))
 - Remaining exposure time ([📖 604](#))
- 5** Exposure compensation indicator ([📖 137](#))
- 6** Exposure and flash bracketing indicator ([📖 171](#))
 - WB bracketing indicator ([📖 176](#))
 - ADL bracketing indicator ([📖 179](#))
 - HDR indicator ([📖 488](#))
 - Multiple exposure indicator ([📖 481](#))
- 7** Aperture lock icon ([📖 660](#))
- 8** Aperture ([📖 128](#), [📖 129](#))
 - Exposure and flash bracketing increment ([📖 171](#))
 - WB bracketing increment ([📖 176](#))
 - Number of shots in ADL bracketing sequence ([📖 179](#))
 - Interval-timer frame count ([📖 494](#))
 - Focus-shift frame count ([📖 515](#))
 - Satellite signal indicator ([📖 194](#))
 - Wi-Fi connection indicator ([📖 310](#), [📖 322](#), [📖 351](#))
 - Bluetooth indicator ([📖 783](#))
 - Computer connection ([📖 891](#))
- 9** Battery indicator ([📖 85](#))
- 10** USB power delivery ([📖 769](#))
- 11** Exposure indicator
 - Exposure ([📖 130](#))
 - Exposure compensation ([📖 137](#))
 - Exposure and flash bracketing ([📖 171](#))
 - WB bracketing ([📖 176](#))
 - ADL bracketing ([📖 179](#))
- 12** ISO sensitivity ([📖 147](#))
- 13** Number of exposures remaining ([📖 86](#), [📖 921](#))
 - Preset manual white balance measurement mode ([📖 165](#))
 - Elapsed exposure time ([📖 132](#))
 - Long-exposure noise reduction processing time remaining ([📖 461](#))
 - Camera control mode ([📖 891](#))
- 14** ISO sensitivity indicator ([📖 147](#))
 - Auto ISO sensitivity indicator ([📖 149](#))
- 15** Release mode ([📖 139](#))
 - Buffer capacity ([📖 139](#))
 - Buffer capacity (high-speed frame capture +; [📖 142](#))
 - Interval timer indicator ([📖 494](#))
 - Time-lapse video indicator ([📖 505](#))
 - Focus shift indicator ([📖 515](#))
- 16** Memory card indicator (Slot 2; [📖 447](#))
- 17** Memory card indicator (Slot 1; [📖 447](#))
- 18** AF-area mode ([📖 112](#))
- 19** Focus mode ([📖 110](#))
- 20** Shooting menu bank ([📖 439](#))
- 21** Flash compensation indicator ([📖 411](#))

Video Mode

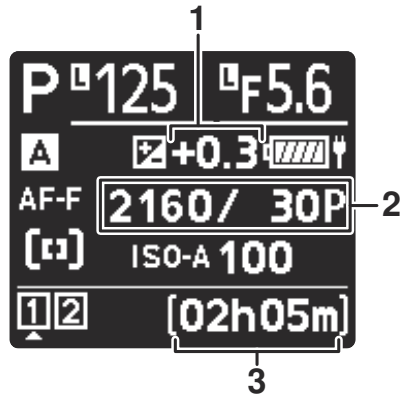

- 1** Exposure compensation value (videos; [book 137](#))
- 2** Frame size and rate ([book 205](#))
- 3** Available recording time ([book 528](#))

Compatible Flash Units

The Nikon Creative Lighting System (CLS)

Nikon's advanced Creative Lighting System (CLS) supports a variety of features thanks to improved communication between the camera and compatible flash units.

Features Available with CLS-Compatible Flash Units

Flash unit	
SB-5000	847
SB-910/SB-900/SB-800	850
SB-700	853
SB-600	856
SB-500	859
SB-R200	862
SB-400	865
SB-300	868
SU-800	871

The SB-5000



Supported features

Single flash

i-TTL	i-TTL balanced fill-flash	✓ ¹
	Standard i-TTL fill-flash	✓ ²
A	Auto aperture	✓
A	Non-TTL auto	—
GN	Distance-priority manual	✓
M	Manual	✓
RPT	Repeating flash	✓

Supported features

Optical Advanced Wireless Lighting

Master			
	Remote flash control		✓
	i-TTL	i-TTL	✓
	[A : B]	Quick wireless flash control	✓
	 A	Auto aperture	✓
	A	Non-TTL auto	—
	M	Manual	✓
	RPT	Repeating flash	✓
Remote			
	i-TTL	i-TTL	✓
	[A : B]	Quick wireless flash control	✓
	 A/A	Auto aperture/non-TTL auto	✓ ³
	M	Manual	✓
	RPT	Repeating flash	✓
Radio-controlled Advanced Wireless Lighting			✓ ⁴
Color Information Communication (flash)			✓
Color Information Communication (LED light)			—
Auto FP high-speed sync			✓ ⁵
FV lock			✓ ⁶
Red-eye reduction			✓

Supported features

Camera modeling illumination	✓
Unified flash control	✓
Camera flash unit firmware update	✓

- 1 Not available with spot metering.
- 2 Can also be selected via the flash unit.
- 3 Choice of **⊗A** and **A** depends on the option selected with the master flash.
- 4 Supports the same features as remote flash units with optical AWL.
- 5 Available only in **i-TTL**, **⊗A**, **A**, **GN**, and **M** flash-control modes.
- 6 Available only in **i-TTL** flash control mode or when the flash is configured to emit monitor preflashes in **⊗A** or **A** flash control mode.

The SB-910, SB-900, and SB-800



Supported features

Single flash

i-TTL	i-TTL balanced fill-flash	✓ ¹
	Standard i-TTL fill-flash	✓ ²
Ⓐ	Auto aperture	✓ ³
A	Non-TTL auto	✓ ³
GN	Distance-priority manual	✓
M	Manual	✓
RPT	Repeating flash	✓

Supported features

Optical Advanced Wireless Lighting

Master			
	Remote flash control		✓
	i-TTL	i-TTL	✓
	[A : B]	Quick wireless flash control	—
	 A	Auto aperture	✓
	A	Non-TTL auto	—
	M	Manual	✓
	RPT	Repeating flash	✓
Remote			
	i-TTL	i-TTL	✓
	[A : B]	Quick wireless flash control	✓
	 A/A	Auto aperture/non-TTL auto	✓ ⁴
	M	Manual	✓
	RPT	Repeating flash	✓
Radio-controlled Advanced Wireless Lighting			—
Color Information Communication (flash)			✓
Color Information Communication (LED light)			—
Auto FP high-speed sync			✓ ⁵
FV lock			✓ ⁶
Red-eye reduction			✓

Supported features

Camera modeling illumination	✓
Unified flash control	—
Camera flash unit firmware update	✓ ⁷

- 1 Not available with spot metering.
- 2 Can also be selected via the flash unit.
- 3 **⊗A/A** mode selection is performed on the flash unit using custom settings.
- 4 Choice of **⊗A** and **A** depends on the option selected with the master flash.
- 5 Available only in **i-TTL**, **⊗A**, **A**, **GN**, and **M** flash-control modes.
- 6 Available only in **i-TTL** flash control mode or when the flash is configured to emit monitor preflashes in **⊗A** or **A** flash control mode.
- 7 Firmware updates for the SB-910 and SB-900 can be performed from the camera.

The SB-700

Supported features

Single flash

i-TTL	i-TTL balanced fill-flash	✓ ¹
	Standard i-TTL fill-flash	✓
Ⓐ	Auto aperture	—
A	Non-TTL auto	—
GN	Distance-priority manual	✓
M	Manual	✓
RPT	Repeating flash	—

Supported features

Optical Advanced Wireless Lighting

Master			
	Remote flash control		✓
	i-TTL	i-TTL	✓
	[A : B]	Quick wireless flash control	✓
	 A	Auto aperture	—
	A	Non-TTL auto	—
	M	Manual	✓
	RPT	Repeating flash	—
Remote			
	i-TTL	i-TTL	✓
	[A : B]	Quick wireless flash control	✓
	 A/A	Auto aperture/non-TTL auto	—
	M	Manual	✓
	RPT	Repeating flash	✓
Radio-controlled Advanced Wireless Lighting			—
Color Information Communication (flash)			✓
Color Information Communication (LED light)			—
Auto FP high-speed sync			✓ ²
FV lock			✓ ³
Red-eye reduction			✓

Supported features

Camera modeling illumination	✓
Unified flash control	—
Camera flash unit firmware update	✓

- 1 Not available with spot metering.
- 2 Available only in **i-TTL**, **GN**, and **M** flash-control modes.
- 3 Available only in **i-TTL** flash-control mode.

The SB-600

Supported features

Single flash

i-TTL	i-TTL balanced fill-flash	✓ ¹
	Standard i-TTL fill-flash	✓ ²
A	Auto aperture	—
A	Non-TTL auto	—
GN	Distance-priority manual	—
M	Manual	✓
RPT	Repeating flash	—

Supported features

Optical Advanced Wireless Lighting

Master			
	Remote flash control		—
	i-TTL	i-TTL	—
	[A : B]	Quick wireless flash control	—
	 A	Auto aperture	—
	A	Non-TTL auto	—
	M	Manual	—
	RPT	Repeating flash	—
Remote			
	i-TTL	i-TTL	✓
	[A : B]	Quick wireless flash control	✓
	 A/A	Auto aperture/non-TTL auto	—
	M	Manual	✓
	RPT	Repeating flash	✓
Radio-controlled Advanced Wireless Lighting			—
Color Information Communication (flash)			✓
Color Information Communication (LED light)			—
Auto FP high-speed sync			✓ ³
FV lock			✓ ⁴
Red-eye reduction			✓

Supported features

Camera modeling illumination	✓
Unified flash control	—
Camera flash unit firmware update	—

- 1 Not available with spot metering.
- 2 Can also be selected via the flash unit.
- 3 Available only in **i-TTL** and **M** flash-control modes.
- 4 Available only in **i-TTL** flash-control mode.

The SB-500

Supported features

Single flash

i-TTL	i-TTL balanced fill-flash	✓ ¹
	Standard i-TTL fill-flash	✓
Ⓐ	Auto aperture	—
A	Non-TTL auto	—
GN	Distance-priority manual	—
M	Manual	✓ ²
RPT	Repeating flash	—

Supported features

Optical Advanced Wireless Lighting

Master			
	Remote flash control		✓ ²
	i-TTL	i-TTL	✓ ²
	[A : B]	Quick wireless flash control	—
	⊗A	Auto aperture	—
	A	Non-TTL auto	—
	M	Manual	✓ ²
	RPT	Repeating flash	—
Remote			
	i-TTL	i-TTL	✓
	[A : B]	Quick wireless flash control	✓
	⊗A/A	Auto aperture/non-TTL auto	—
	M	Manual	✓
	RPT	Repeating flash	✓
Radio-controlled Advanced Wireless Lighting			—
Color Information Communication (flash)			✓
Color Information Communication (LED light)			✓
Auto FP high-speed sync			✓ ³
FV lock			✓ ⁴
Red-eye reduction			✓

Supported features

Camera modeling illumination	✓
Unified flash control	✓
Camera flash unit firmware update	✓

- 1 Not available with spot metering.
- 2 Can be selected using the [**Flash control**] item in the camera menus.
- 3 Available only in **i-TTL** and **M** flash-control modes.
- 4 Available only in **i-TTL** flash-control mode.

The SB-R200

Supported features

Single flash

	i-TTL	i-TTL balanced fill-flash	—
		Standard i-TTL fill-flash	—
	A	Auto aperture	—
	A	Non-TTL auto	—
	GN	Distance-priority manual	—
	M	Manual	—
	RPT	Repeating flash	—

Supported features

Optical Advanced Wireless Lighting

Master			
	Remote flash control		—
	i-TTL	i-TTL	—
	[A : B]	Quick wireless flash control	—
	⊗A	Auto aperture	—
	A	Non-TTL auto	—
	M	Manual	—
	RPT	Repeating flash	—
Remote			
	i-TTL	i-TTL	✓
	[A : B]	Quick wireless flash control	✓
	⊗A/A	Auto aperture/non-TTL auto	—
	M	Manual	✓
	RPT	Repeating flash	—
Radio-controlled Advanced Wireless Lighting			—
Color Information Communication (flash)			—
Color Information Communication (LED light)			—
Auto FP high-speed sync			✓ ¹
FV lock			✓ ²
Red-eye reduction			—

Supported features

Camera modeling illumination	✓
Unified flash control	—
Camera flash unit firmware update	—

1 Available only in **i-TTL** and **M** flash-control modes.

2 Available only in **i-TTL** flash-control mode.

The SB-400



Supported features

Single flash

i-TTL	i-TTL balanced fill-flash	✓ ¹
	Standard i-TTL fill-flash	✓
Ⓐ	Auto aperture	—
A	Non-TTL auto	—
GN	Distance-priority manual	—
M	Manual	✓ ²
RPT	Repeating flash	—

Supported features

Optical Advanced Wireless Lighting

Master			
	Remote flash control		—
	i-TTL	i-TTL	—
	[A : B]	Quick wireless flash control	—
	 A	Auto aperture	—
	A	Non-TTL auto	—
	M	Manual	—
	RPT	Repeating flash	—
Remote			
	i-TTL	i-TTL	—
	[A : B]	Quick wireless flash control	—
	 A/A	Auto aperture/non-TTL auto	—
	M	Manual	—
	RPT	Repeating flash	—
Radio-controlled Advanced Wireless Lighting			—
Color Information Communication (flash)			✓
Color Information Communication (LED light)			—
Auto FP high-speed sync			—
FV lock			✓ ³
Red-eye reduction			✓

Supported features

Camera modeling illumination	—
Unified flash control	✓
Camera flash unit firmware update	—

- 1 Not available with spot metering.
- 2 Can be selected using the [**Flash control**] item in the camera menus.
- 3 Available only in **i-TTL** flash-control mode.

The SB-300



Supported features

Single flash

i-TTL	i-TTL balanced fill-flash	✓ ¹
	Standard i-TTL fill-flash	✓
Ⓐ	Auto aperture	—
A	Non-TTL auto	—
GN	Distance-priority manual	—
M	Manual	✓ ²
RPT	Repeating flash	—

Supported features

Optical Advanced Wireless Lighting

Master			
	Remote flash control		—
	i-TTL	i-TTL	—
	[A : B]	Quick wireless flash control	—
	 A	Auto aperture	—
	A	Non-TTL auto	—
	M	Manual	—
	RPT	Repeating flash	—
Remote			
	i-TTL	i-TTL	—
	[A : B]	Quick wireless flash control	—
	 A/A	Auto aperture/non-TTL auto	—
	M	Manual	—
	RPT	Repeating flash	—
Radio-controlled Advanced Wireless Lighting			—
Color Information Communication (flash)			✓
Color Information Communication (LED light)			—
Auto FP high-speed sync			—
FV lock			✓ ³
Red-eye reduction			—

Supported features

Camera modeling illumination	—
Unified flash control	✓
Camera flash unit firmware update	✓

- 1 Not available with spot metering.
- 2 Can be selected using the [**Flash control**] item in the camera menus.
- 3 Available only in **i-TTL** flash-control mode.

The SU-800 Wireless Speedlight Commander

When mounted on a CLS-compatible camera, the SU-800 can be used as a commander for SB-5000, SB-910, SB-900, SB-800, SB-700, SB-600, SB-500, or SB-R200 flash units. Group flash control is supported for up to three groups. The SU-800 itself is not equipped with a flash.

Supported features

Single flash

i-TTL	i-TTL balanced fill-flash	—
	Standard i-TTL fill-flash	—
A	Auto aperture	—
A	Non-TTL auto	—
GN	Distance-priority manual	—
M	Manual	—
RPT	Repeating flash	—

Supported features

Optical Advanced Wireless Lighting

Master			
	Remote flash control		✓
	i-TTL	i-TTL	—
	[A : B]	Quick wireless flash control	✓ ¹
	⊗A	Auto aperture	—
	A	Non-TTL auto	—
	M	Manual	—
	RPT	Repeating flash	—
Remote			
	i-TTL	i-TTL	—
	[A : B]	Quick wireless flash control	—
	⊗A/A	Auto aperture/non-TTL auto	—
	M	Manual	—
	RPT	Repeating flash	—
Radio-controlled Advanced Wireless Lighting			—
Color Information Communication (flash)			—
Color Information Communication (LED light)			—
Auto FP high-speed sync			✓ ²
FV lock			✓ ³
Red-eye reduction			—

Supported features

Camera modeling illumination	✓
Unified flash control	—
Camera flash unit firmware update	—

- 1 Available during close-up photography only.
- 2 Not available when **RPT** is selected as the flash control mode for the remote flash unit.
- 3 Available only when **i-TTL** is selected as the flash control mode for the remote flash unit or when the flash is configured to emit monitor preflashes in mode **Ⓐ**.

Notes on Optional Flash Units

Be sure also to consult documentation for the optional flash unit before use.

- If the unit supports CLS, refer to the section on CLS-compatible digital SLR cameras. This camera is not included in the “digital SLR” category in the documentation for the SB-80DX, SB-28DX, and SB-50DX.
- If the flash-ready indicator (⚡) flashes for about three seconds after a photograph is taken in i-TTL or non-TTL auto mode, the flash has fired at full power and the photograph may be underexposed (CLS-compatible flash units only).
- i-TTL flash control can be used at ISO sensitivities between 64 and 12800 equivalent.
- At ISO sensitivities over 12800, the desired results may not be achieved at some ranges or aperture settings.
- In mode **P**, the maximum aperture (minimum f-number) is limited according to ISO sensitivity, as shown below:

Maximum aperture (f-number) at ISO equivalent of:							
100	200	400	800	1600	3200	6400	12800
4	5	5.6	7.1	8	10	11	13

* If the maximum aperture of the lens is smaller than given above, the maximum value for aperture will be the maximum aperture of the lens.

- The SB-5000, SB-910, SB-900, SB-800, SB-700, SB-600, SB-500, and SB-400 provide red-eye reduction in red-eye reduction and slow-sync with red-eye reduction flash modes.
- “Noise” in the form of lines may appear in flash photographs taken with an SD-9 or SD-8A high-performance battery pack attached directly to the camera. Reduce ISO sensitivity or increase the distance between the camera and the battery pack.
- The camera provides AF-assist illumination as required. AF-assist illuminators on optional flash units will not light.
- When an SC-series 17, 28, or 29 sync cable is used for off-camera flash photography, correct exposure may not be achieved in i-TTL mode. We recommend that you select standard i-TTL fill-flash. Take a test shot and view the results in the camera display.
- In i-TTL, do not use any form of flash panel (diffusion panel) other than the flash unit’s built-in flash panel or supplied bounce adapter. Using other panels may produce incorrect exposure.

✓ Flash Photography

Flash photography cannot be combined with some camera features, including:

- silent mode,
- video recording,
- high-speed frame capture +, and
- HDR overlay.

✓ Using FV Lock with Optional Flash Units

- FV lock is available with optional flash units in TTL and (where supported) monitor pre-flash **⊗A** and monitor pre-flash **A** flash control modes (see the documentation provided with the flash unit for more information).
- Note that when Advanced Wireless Lighting is used to control remote flash units, you will need to set the flash control mode for the master or at least one remote group to **TTL**, **⊗A**, or **A**.

✓ Other Flash Units

The following flash units can be used in non-TTL auto (**A**) and manual modes. The options available do not vary with the lens used.

Flash unit	Supported features
SB-80DX, SB-28DX, SB-28, SB-26, SB-25, SB-24	Non-TTL auto, manual, repeating flash, rear-curtain sync ¹
SB-50DX, SB-23, SB-29, SB-21B, SB-29S	Manual, rear-curtain sync ¹
SB-30, SB-27 ² , SB-22S, SB-22, SB-20, SB-16B, SB-15	Non-TTL auto, manual, rear-curtain sync ¹

¹ Available when the camera is used to select the flash mode.

² Mounting an SB-27 on the camera automatically sets the flash mode to **TTL**, but setting the flash mode to **TTL** disables the shutter release. Set the SB-27 to **A**.

✓ Metering Areas for FV Lock

The areas metered when FV lock is used with optional flash units are as follows:

- Stand-Alone

Flash control mode	Metered area
i-TTL	6-mm circle in center of frame
Auto aperture (Ⓐ)	Area metered by flash exposure meter

- Remote

Flash control mode	Metered area
i-TTL	Entire frame
Auto aperture (Ⓐ)	Area metered by flash exposure meter
Non-TTL auto (A)	

✓ Flash Compensation for Optional Flash Units

In i-TTL and auto aperture (Ⓐ) flash control modes, the flash compensation selected with the optional flash unit or with **[Flash control]** in the camera photo shooting menu is added to the flash compensation selected with the **[Flash compensation]** item in the photo shooting menu.

Tip: Modeling Illumination

- Pressing the control to which [**Preview**] has been assigned using Custom Setting f2 [**Custom controls (shooting)**] causes CLS-compatible flash units to emit a modeling flash.
- This feature can be used with Advanced Wireless Lighting to preview the total lighting effect achieved with multiple flash units.
- The effects of shadows cast by the flash are best observed directly rather than in the shooting display.
- Modeling illumination can be turned off by selecting [**OFF**] for Custom Setting e5 [**Modeling flash**].

Tip: Studio Strobe Lighting

To adjust the color and brightness of the view through the lens so that shots are easier to frame, select [**Adjust for ease of viewing**] for Custom Setting d9 [**View mode (photo Lv)**].

Compatible Accessories

A variety of accessories are available for your Nikon camera.

✔ Compatible Accessories

- Availability may vary with country or region.
 - See our website or brochures for the latest information.
-

• Power Sources

- **EN-EL18d Rechargeable Li-ion Battery:** EN-EL18d batteries can be used with Nikon Z 9 digital cameras.
 - EN-EL18c, EN-EL18b, EN-EL18a, and EN-EL18 batteries can also be used. Note, however, that fewer pictures can be taken on a single charge than with the EN-EL18d ([📖 923](#)).
- **MH-33 Battery Charger:** The MH-33 can be used to recharge EN-EL18d batteries. Batteries can be charged while the charger is connected to a power source via the EH-7P charging AC adapter.
- **EH-7P Charging AC Adapter:** The EH-7P can be used to charge batteries inserted in the camera.
 - The battery will not charge while the camera is on.
 - Charging AC adapters cannot be used to charge EN-EL18a or EN-EL18 batteries.
 - The charging AC adapter can be used to power the camera; to do so, select **[ON]** for **[USB power delivery]** in the setup menu. For more information, see “USB Power Delivery” ([📖 769](#)).
- **EP-6a Power Connector, EH-6d AC Adapter:** Use AC adapters to power the camera for extended periods.
 - The EP-6a is needed to connect the EH-6d to the camera. See “Attaching a Power Connector and AC Adapter” ([📖 889](#)) for details.
 - EH-6c, EH-6b, EH-6a, and EH-6 AC adapters can be used in place of the EH-6d.

• Filters

- Neutral Color (NC) filters can be used to protect the lens.
- Filters may cause ghosting when the subject is framed against a bright light, or when a bright light source is in the frame. Filters can be removed if ghosting occurs.
- Matrix metering may not produce the desired results with filters with exposure factors (filter factors) over 1× (Y44, Y48, Y52, O56, R60, X0, X1, C-PL, ND2S, ND4, ND4S, ND8, ND8S, ND400, A2, A12, B2, B8, B12); we suggest that [**Center-weighted metering**] be selected instead. See the documentation provided with the filter for details.
- Filters intended for special-effects photography may interfere with autofocus or the in-focus indicator (●).

• Remote Terminal Accessories

The camera is equipped with a ten-pin remote terminal for remote control and automatic photography.

Be sure to replace the terminal cap when the terminal is not in use. Dust or other foreign matter accumulating in the terminal contacts could cause the camera to malfunction.

- **MC-22/MC-22A Remote Cords (length approximately 1 m/3.3 ft):** Remote shutter releases with blue, yellow, and black terminals for connection to remote shutter-triggering devices, allowing control via sound or electronic signals.
- **MC-30/MC-30A Remote Cords (length approximately 80 cm/2.7 ft):** Remote shutter releases; can be used to reduce camera shake.
- **MC-36/MC-36A Remote Cords (length approximately 85 cm/2.8 ft):** Remote shutter releases with timers for interval-timer photography.
- **MC-21/MC-21A Extension Cords (length approximately 3 m/9.9 ft):** Can be connected to ML-3 or MC-series 20, 22, 22A, 23, 23A, 25, 25A, 30, 30A, 36, or 36A, but note that two or more extension cords cannot be connected together.
- **MC-23/MC-23A Connecting Cords (length approximately 40 cm/1.4 ft):** Use an MC-23 or 23A to connect two cameras via their ten-pin terminals for simultaneous operation.
- **MC-25/MC-25A Adapter Cords (length approximately 20 cm/7.9 in.):** Ten-pin to two-pin adapter cords for connection to devices with two-pin terminals, including the MW-2 radio control set, MT-2 intervalometer, and ML-2 modulite remote control set.
- **WR-A10 WR Adapter:** An adapter used to connect WR-R10 wireless remote controllers to cameras with ten-pin remote terminals.
- **ML-3 Modulite Remote Control Set:** Allows infrared remote control at ranges of up to 8 m (26.2 ft).

- **USB Cables**

- **UC-E24 USB Cable:** A USB cable with a type C connector for connection to the camera and a type A connector for connection to the USB device.
- **UC-E25 USB Cable:** A USB cable with two type C connectors.

- **Accessory Shoe Covers**

BS-1 Accessory Shoe Cover: A cover protecting the accessory shoe when no flash unit is attached.

- **Body Caps**

BF-N1 Body Cap: The body cap prevents dust entering the camera when no lens is in place.

- **Viewfinder Eyepiece Accessories**

DK-33 Rubber Eyecup: A rubber eyecup that comes fitted to the camera. It can be removed by holding the eyepiece release (①) and rotating the eyecup in the direction shown (②).

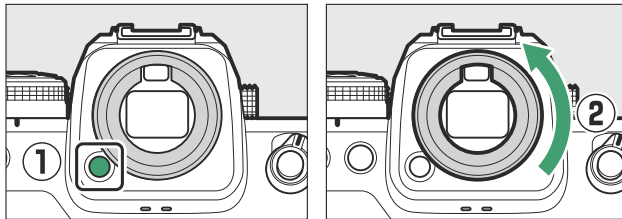

To re-attach the eyecup, align the mark on the rear of the eyecup (④) with the mark on the camera body (③) and rotate the eyecup as shown until it clicks into place (⑤).

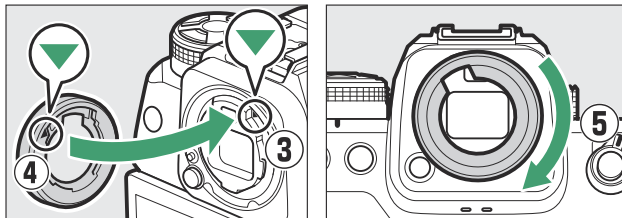

• Flash Units

- **SB-5000, SB-910, SB-900, SB-800, SB-700, SB-600, SB-500, SB-400, SB-300, and SB-R200 Speedlights:** These units can be mounted on the camera for flash photography. Some also support wireless remote control for off-camera flash photography with multiple flash units.
 - See the documentation supplied with each Speedlight for information on mounting the unit on the camera.
 - For more information on flash photography, see “‘On-Camera’ Versus ‘Remote’” ([403](#)), “What Is Remote Flash Photography?” ([414](#)), and “Compatible Flash Units” ([846](#)).
- **SU-800 Wireless Speedlight Commander:** A wireless commander for use with SB-5000, SB-910, SB-900, SB-800, SB-700, SB-600, SB-500, and SB-R200 flash units. Flash units can be divided into up to three groups for remote flash control. The SU-800 itself is not equipped with a flash.

• Mount Adapters

FTZ II/FTZ Mount Adapter: An adapter that allows NIKKOR F mount lenses to be used with digital cameras that support interchangeable Z mount lenses.

- For information on attaching, removing, maintaining, and using mount adapters, refer to the product documentation.
 - * Update to the latest version of the mount adapter firmware if so prompted after attaching the adapter. Information on performing firmware updates is available via the Nikon website for your country or region.
- Users of the FTZ should note that the lack of space between adapter and grip can make the grip difficult to use.

• Microphones

- **ME-1 Stereo Microphone:** Connect the ME-1 to the camera microphone jack to record stereo sound. Using an external microphone also reduces the chance of picking up equipment noise, such as the sounds produced during video recording when focus is achieved using autofocus.
- **ME-W1 Wireless Microphone:** A wireless Bluetooth microphone. Use the ME-W1 for off-camera recording.

• Wireless Remote Controllers

• **WR-R11a, WR-R10, and WR-T10 Wireless Remote Controllers**

- When a WR-R11a is connected to the ten-pin remote terminal, or when a WR-R10 is connected to the ten-pin remote terminal using a WR-A10 adapter, the camera can be controlled remotely using a WR-T10 wireless remote controller.
- WR-R11a and WR-R10 wireless remote controllers can also be used to control radio-controlled flash units.

• **WR-1 Wireless Remote Controller:** WR-1 units are used with WR-R11a/WR-R10 or WR-T10 wireless remote controllers or with other WR-1 remote controllers, with the WR-1 units functioning as either transmitters or receivers. When a WR-R11a/WR-R10 or a WR-1 configured as a receiver is connected to the camera ten-pin remote terminal, a second WR-1 configured as a transmitter can be used to take pictures and adjust camera settings remotely. Update the WR-1 firmware to the latest version (version 1.0.4 or later).

- * When using a wireless remote controller with the WR-R10, be sure the firmware for the WR-R10 has been updated to the latest version (version 3.0 or later). For information on firmware updates, see the Nikon website for your area. Consult a Nikon-authorized service representative when updating the firmware for the WR-R10 from versions prior to version 2.0 to version 3.0 or later.

• Remote Grips

MC-N10 Remote Grip: When connected to the camera, the MC-N10 can be used for such tasks as video recording, photography, and adjusting camera settings. It comes equipped with a rosette for attachment to third-party camera equipment. With the MC-N10 mounted on third-party camera equipment via an ARRI-compatible rosette adapter, you can keep moving subjects in focus while panning the camera to track their motion, or use its conveniently-placed controls to adjust settings such as exposure and white balance without touching the camera.

✓ Charging Batteries

Compatible batteries can be charged using the devices below.

Battery	Battery charger		Charging AC adapter
	MH-33	MH-26a	
EN-EL18d	✓	—	✓
EN-EL18c	✓	✓	✓
EN-EL18b	✓	✓	✓
EN-EL18a	—	✓	—
EN-EL18	—	✓	—

✓ Attaching and Removing the Accessory Shoe Cover

The BS-1 accessory shoe cover slides into the shoe as shown. To remove the cover, hold the camera firmly, press the cover down with a thumb and slide it in the direction shown.

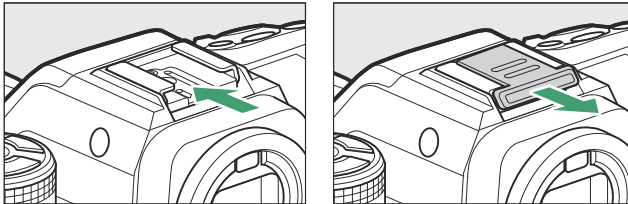

The HDMI/USB Cable Clip

To prevent accidental disconnection, attach the supplied clip to HDMI or USB cables as shown (note that the clip may not fit all cables).

- The illustrations show the USB cable. Pass HDMI cables through the other channel.
- Keep the monitor in the storage position when using the cable clip.

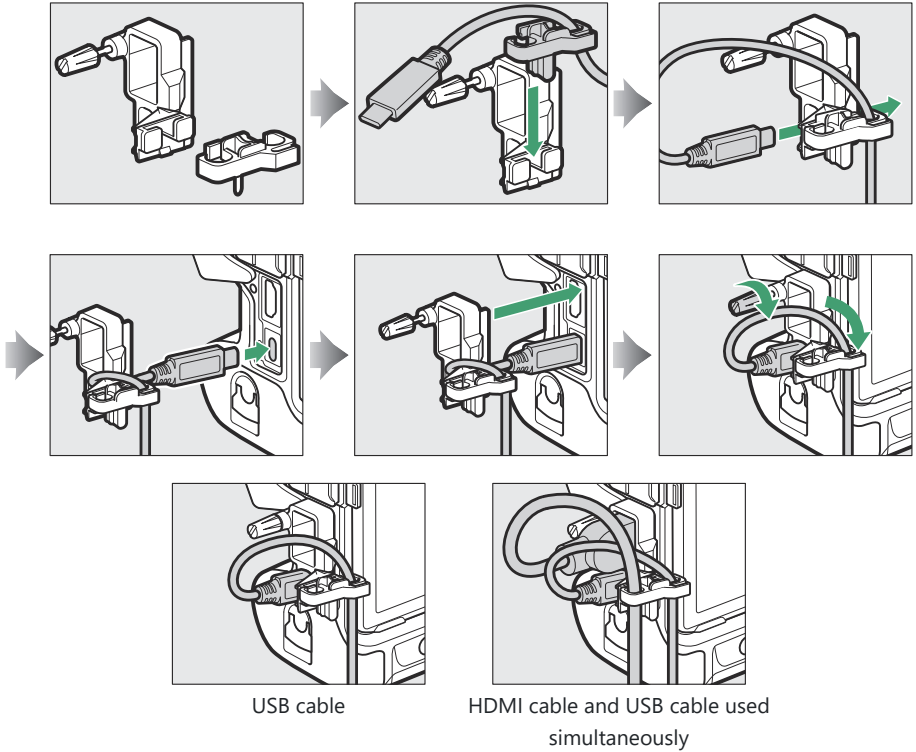

The Memory Card Slot Cover

The camera features a removable memory card slot cover.

- After opening the memory card slot cover, slide the memory card slot cover release latch in the direction shown until it latches (①) and then remove the cover from the camera (②).

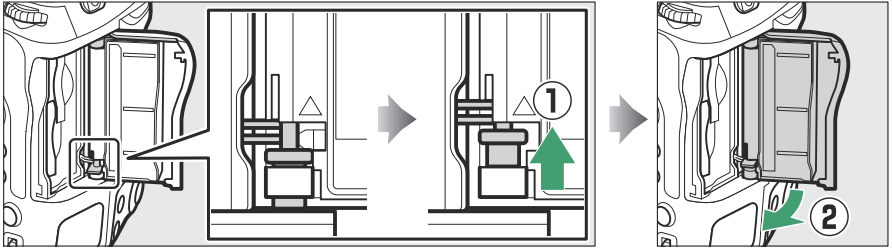

- Be careful not to slide the memory card slot cover release latch back down after removing the memory card slot cover. The cover cannot be re-attached with the latch lowered.

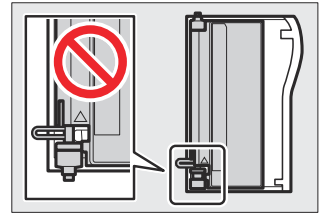

- The inner cover may move when the memory card slot cover release latch is lowered. The memory card slot cover cannot be reattached when the inner cover is out of position. Slide the memory card slot cover latch down (①) and restore the inner and outer covers to their original positions (②).

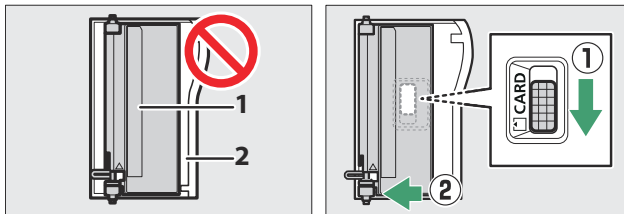

- 1 Inner cover
- 2 Outer cover

- To re-attach the memory card slot cover, follow the steps below.
 - Insert the top hinge into the top socket on the camera body (①).

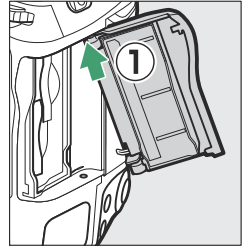

- Insert the end of the sprung hinge (③) into the hinge socket (②).

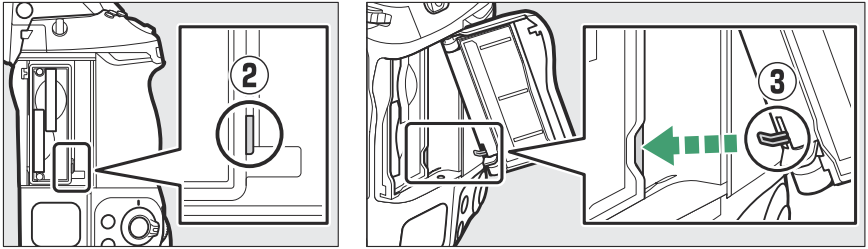

- Keeping the bottom hinge aligned with the bottom socket (④), slide the memory card slot cover release latch down until it clicks into place in its original position (⑤).

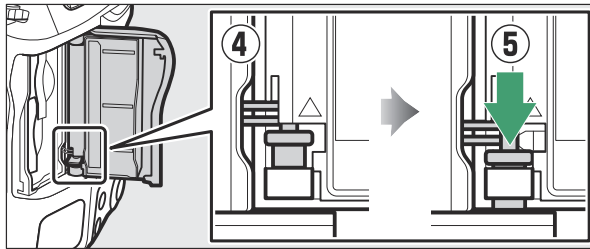

Calibrating Batteries

The MH-33 battery charger can detect whether batteries require calibration and calibrate them as necessary to ensure the accuracy of the battery level display.

Calibration status and progress are shown by lamps on the battery charger:

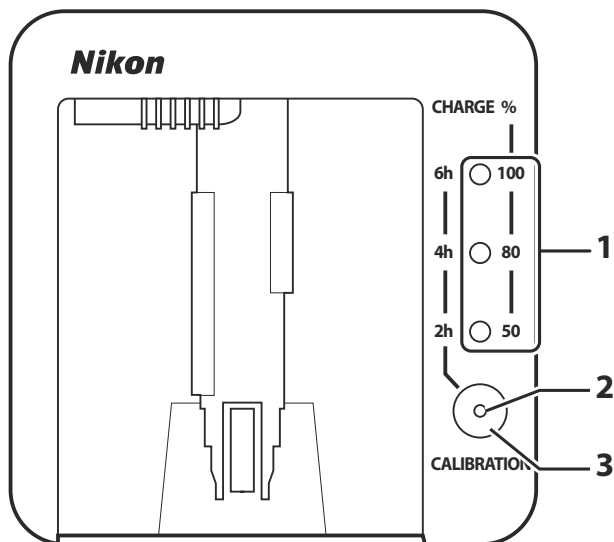

- 1** Charge lamps
- 2** Calibration lamp
- 3** Calibration button

If the calibration lamp flashes when a battery is inserted, the battery needs to be calibrated.

To begin calibration, press the calibration button for about a second. The charge lamps and calibration lamp light red while calibration is in progress. The display can be read as follows:

		Approximate time needed to recalibrate battery			
		Under 2 hours	2–4 hours	4–6 hours	Over 6 hours
Charge lamps	2h	● (off)	○ (on)	○ (on)	○ (on)
	4h	● (off)	● (off)	○ (on)	○ (on)
	6h	● (off)	● (off)	● (off)	○ (on)
Calibration lamp		○ (on)	○ (on)	○ (on)	○ (on)

Although calibration is recommended for accurate measurement of battery charge state, calibration need not be performed when the calibration lamp flashes. Once begun, calibration can be interrupted as desired.

- If the calibration button is not pressed while the calibration lamp is flashing, normal charging will begin after about ten seconds.
- To interrupt calibration, press the calibration button again. Calibration will end and charging will begin.

When calibration is complete, the charge lamps and calibration lamp will turn off and charging will begin immediately.

Attaching a Power Connector and AC Adapter

Turn the camera off before attaching an optional power connector and AC adapter.

1 Remove the BL-7 battery chamber cover.

Lift the battery chamber cover latch, turn it to the open (⊞) position (①), and remove the BL-7 battery chamber cover (②).

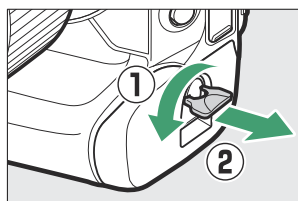

2 Connect the EH-6d AC adapter to the EP-6a power connector.

- Pass the DC cable over the power connector cable guide (①) and slide it down until it is at the bottom of the slot.

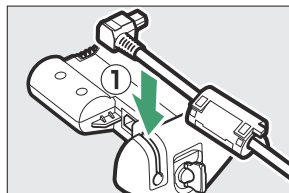

- Insert the DC plug into the DC IN connector (②).

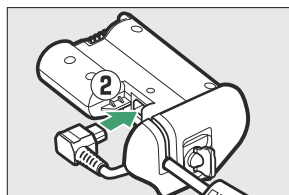

3 Insert the power connector.

Fully insert the power connector into the battery chamber as shown.

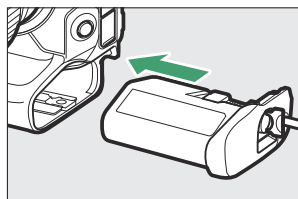

4 Latch the power connector.

- Rotate the latch to the closed position (①) and fold it down as shown (②).

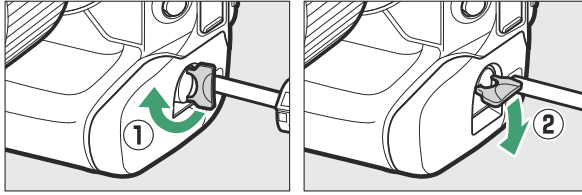

- To prevent the power connector being dislodged during operation, be sure that it is securely latched.
- The battery level is not displayed in the control panel while the camera is powered by the AC adapter and power connector.

Software

The following Nikon software can be used with the camera. For more information, visit the Nikon website for your country or region.

• Computer Software

Nikon computer software is available from the Nikon Download Center. Check the version and system requirements and be sure to download the latest version.

<https://downloadcenter.nikonimglib.com/>

- **Camera Control Pro 2** (available for purchase): Control the camera remotely from a computer to record photos and videos and save them directly to the computer hard disk.
- **NX Tether**: Use for tethered photography when the camera is connected to a computer. Exposure, white balance, and other camera settings can be adjusted remotely using controls in the computer display.
- **NX Studio** ^{*}: View and edit photos and videos shot with Nikon digital cameras. NX Studio can be used to fine-tune files in Nikon's unique NEF/NRW (RAW) format and convert them to JPEG or TIFF (NEF/RAW processing). It supports not only NEF/NRW (RAW) pictures but also JPEG and TIFF photos shot with Nikon digital cameras for such tasks as editing tone curves and enhancing brightness and contrast.
 - * Existing users should be sure to download the latest version, as earlier versions may be unable to download pictures from the camera or open NEF (RAW) pictures.
- **Wireless Transmitter Utility**: The Wireless Transmitter Utility is required if the camera is to be connected to a network. Pair the camera with the computer and download pictures over a wireless or Ethernet network.
- **Webcam Utility**: The Webcam Utility lets you use your camera as a webcam when it is connected to the computer via USB. The camera will appear as "Webcam Utility" in web conferencing apps. Selecting "Webcam Utility" converts the camera into a webcam. For information on compatible cameras, system requirements, and using the Webcam Utility, as well as on the precautions to be observed during use, see the Webcam Utility page in the Nikon Download Center.

• Smartphone (Tablet) Apps

Smartphone (tablet) apps are available from the Apple App Store® and on Google Play™. For the latest information on our apps, visit the Nikon website.

- **SnapBridge**: Download photos and videos from the camera to your smart device via a wireless connection.
- **NX MobileAir** (offers in-app purchases): Import pictures from a camera connected to your smart device via USB and upload them wirelessly to an FTP server.
 - * Supported features and operating systems vary by country and region.

Caring for the Camera

Long-Term Storage

When the camera will not be used for an extended period, remove the battery. Before removing the battery, confirm that the camera is off.

Do not store the camera in locations that:

- are poorly ventilated or subject to humidities of over 60%,
- are next to equipment that produces strong electromagnetic fields, such as televisions or radios, or
- are exposed to temperatures above 50 °C (122 °F) or below –20 °C (–4 °F).

Cleaning

The procedure varies with the part that requires cleaning. The procedures are detailed below.

- Do not use alcohol, thinner, or other volatile chemicals.

Camera Body

Use a blower to remove dust and lint, then wipe gently with a soft, dry cloth. After using the camera at the beach or seaside, wipe off sand or salt with a cloth lightly dampened in distilled water and dry the camera thoroughly.

Important: *Dust or other foreign matter inside the camera may cause product malfunction. Damage due to the presence of foreign matter inside the camera is not covered under warranty.*

Lens and Viewfinder

These glass elements are easily damaged: remove dust and lint with a blower. If using an aerosol blower, keep the can vertical to prevent the discharge of liquid that could damage glass elements. To remove fingerprints and other stains, apply a small amount of lens cleaner to a soft cloth and clean with care.

The Monitor

Remove dust and lint with a blower. When removing smudges, fingerprints, and other oily stains, wipe the surface lightly with a soft cloth or chamois leather. Do not apply pressure, as this could result in damage or malfunction.

Image Sensor Cleaning

Dirt or dust entering the camera when lenses are exchanged or the body cap is removed may adhere to the surface of the image sensor and affect your photographs. The “clean image sensor” option vibrates the sensor to remove dust.

The image sensor can be cleaned at any time from the menus, or cleaning can be performed automatically when the camera is turned off. If image sensor cleaning fails to resolve the problem, contact a Nikon-authorized service representative.

Using the Menu

- For maximum effect, hold the camera in normal orientation (base down).

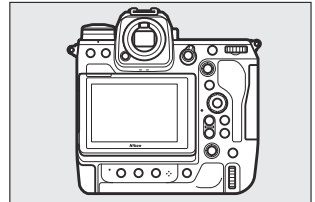

- Select **[Clean image sensor]** in the setup menu, then highlight **[Start]** and press **⊗** to begin cleaning.
- Camera controls cannot be used while cleaning is in progress. Do not remove or disconnect the power source.
- The setup menu will be displayed when cleaning is complete.

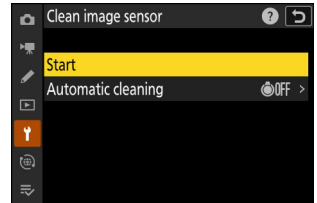

Cleaning the Image Sensor at Shutdown

Option		Description
	[Clean at shutdown]	The image sensor is automatically cleaned during shutdown each time the camera is turned off.
[Cleaning off]		Automatic image sensor cleaning off.

1 Select [Automatic cleaning] for [Clean image sensor].

Pressing  when [Automatic cleaning] is highlighted displays [Automatic cleaning] options.

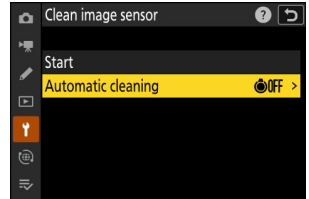

2 Highlight an option.

Press  to select the highlighted option.

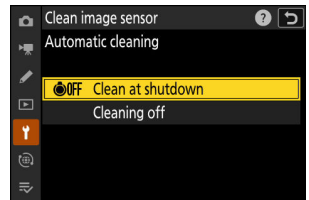

Cautions: Image Sensor Cleaning

- Using camera controls interrupts any image sensor cleaning begun in response to the operation of the power switch.
- If image sensor cleaning is performed several times in succession, image sensor cleaning may be temporarily disabled to protect the camera's internal circuitry. Cleaning can be performed again after a short wait.

Manual Cleaning

If foreign matter cannot be removed from the image sensor using image sensor cleaning, the sensor can be cleaned manually as described below. Note, however, that the sensor is extremely delicate and easily damaged; we recommend that manual cleaning be performed only by a Nikon-authorized service representative.

- Select **[Sensor shield stays open]** for **[Sensor shield behavior at power off]** in the setup menu.

1 Turn the camera off and remove the lens.

2 Holding the camera so that light can enter, examine the image sensor for dust or lint.

If no foreign objects are present, proceed to Step 4.

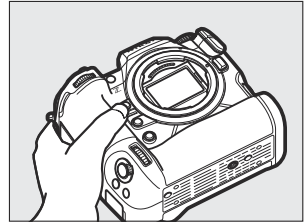

3 Remove any dust and lint from the sensor with a blower.

- Do not use a blower-brush. The bristles could damage the sensor.
- Dirt that cannot be removed with a blower can only be removed by Nikon-authorized service personnel. Under no circumstances should you touch or wipe the sensor.

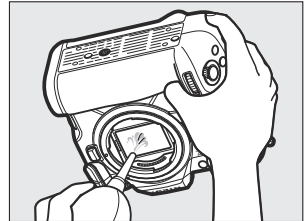

4 Replace the lens or supplied body cap.

✓ Foreign Matter on the Image Sensor

Foreign matter entering the camera when lenses or body caps are removed or exchanged (or in rare circumstances lubricant or fine particles from the camera itself) may adhere to the image sensor, where it may appear in photographs taken under certain conditions. To prevent entry of foreign matter when attaching the body cap or exchanging lenses, avoid dusty environments and be sure to remove all dust and other foreign matter that may be adhering to the camera mount, lens mount, or body cap. To protect the camera when no lens is in place, be sure to replace the supplied body cap. Should you encounter foreign matter that cannot be removed using the image sensor cleaning option ([894](#)), clean the image sensor as described in “Manual Cleaning” ([896](#)), or have the sensor cleaned by authorized Nikon service personnel. Photographs affected by the presence of foreign matter on the sensor can be retouched using the clean image options available in some imaging applications.

✓ Servicing the Camera and Accessories

The camera is a precision device and requires regular servicing; Nikon recommends that the camera be inspected once every one to two years, and that it be serviced once every three to five years (note that fees apply to these services).

- Frequent inspection and servicing are particularly recommended if the camera is used professionally.
 - Any accessories regularly used with the camera, such as lenses or optional flash units, should be included when the camera is inspected or serviced.
-

Caring for the Camera and Battery: Cautions

Cautions: Using the Camera

- **Do Not Drop**

Do not drop the camera or lens or subject them to blows. The product may malfunction if subjected to strong shocks or vibration.

- **Keep Dry**

Keep the camera dry. Rusting of the internal mechanism caused by water inside the camera can not only be expensive to repair but can in fact cause irreparable damage.

- **Avoid Sudden Changes in Temperature**

Taking the camera from a warm to a cold environment or vice versa may cause damaging condensation inside and outside the camera. Place the camera in a sealed bag or plastic case before taking it across a temperature boundary. The camera can be taken from the bag or case once it has had time to adjust to the new temperature.

- **Keep Away from Strong Magnetic Fields**

Static charges or the magnetic fields produced by equipment such as radio transmitters could interfere with the monitor, corrupt data stored on the memory card, or affect the product's internal circuitry.

- **Do Not Leave the Lens Pointed at the Sun**

Do not leave the lens pointed at the sun or other strong light sources. Intense light may damage the image sensor or cause fading or "burn in". Photographs taken with the camera may exhibit a white blur effect.

- **Keep Credit Cards and Other Such Magnetic Storage Devices Away from the Camera and Lens**

Data stored on the device could be corrupted.

- **Lasers and Other Bright Light Sources**

Do not direct lasers or other extremely bright light sources toward the lens, as this could damage the camera's image sensor.

- **Cleaning**

When cleaning the camera body, use a blower to gently remove dust and lint, then wipe gently with a soft, dry cloth. After using the camera at the beach or seaside, wipe off any sand or salt using a cloth lightly dampened in fresh water and then dry the camera thoroughly. In rare instances, static electricity may cause the LCD displays to light up or go dark; this does not indicate a malfunction. The display will soon return to normal.

- **Cleaning the Lens and Viewfinder**

These glass elements are easily damaged: remove dust and lint with a blower. If using an aerosol blower, keep the can vertical to prevent the discharge of liquid that could damage glass elements. To remove fingerprints and other stains from the lens, apply a small amount of lens cleaner to a soft cloth and wipe the lens carefully.

- **Do Not Touch the Image Sensor**

Under no circumstances should you exert pressure on the image sensor, poke it with cleaning tools, or subject it to powerful air currents from a blower. These actions could scratch or otherwise damage the sensor.

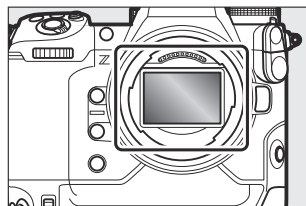

- **Cleaning the Image Sensor**

For information on cleaning the image sensor, see "Image Sensor Cleaning" ([📖 894](#)) and "Manual Cleaning" ([📖 896](#)).

- **Do Not Touch the Sensor Shield**

If [**Sensor shield closes**] is selected for [**Sensor shield behavior at power off**] in the setup menu, the sensor shield in front of the image sensor will close when the camera turns off. Never pierce or apply pressure to the sensor shield. Failure to observe this precaution could scratch or otherwise damage the shield.

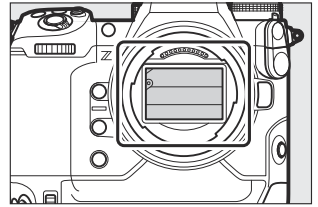

- **The Lens Contacts**

Keep the lens contacts clean. Avoid touching them with your fingers.

- **Store in a Well-Ventilated Area**

To prevent mold or mildew, store the camera in a dry, well-ventilated area. Do not store the camera with naphtha or camphor moth balls, next to equipment that produces strong electromagnetic fields, or where it will be exposed to extremely high temperatures, for example near a heater or in an enclosed vehicle on a hot day. Failure to observe these precautions could result in product malfunction.

- **Long-Term Storage**

To prevent damage caused for example by leaking battery fluid, remove the battery if the product will not be used for an extended period. Store the camera in a plastic bag containing a desiccant. Do not, however, store the leather camera case in a plastic bag, as this may cause the material to deteriorate. Store the battery in a cool, dry place. Note that desiccant gradually loses its capacity to absorb moisture and should be replaced at regular intervals. To prevent mold or mildew, take the camera out of storage at least once a month, insert the battery, and release the shutter a few times.

- **Turn the Product Off Before Removing or Disconnecting the Power Source**

Removing or disconnecting the power source while the camera is on could damage the product. Particular care should be taken not to remove or disconnect the power source while pictures are being recorded or deleted.

• **Monitor/Viewfinder**

- The monitors (including viewfinder) are constructed with extremely high precision; at least 99.99% of pixels are effective, with no more than 0.01% being missing or defective. Hence while these displays may contain pixels that are always lit (white, red, blue, or green) or always off (black), this is not a malfunction. Pictures recorded with the device are unaffected. Your understanding is requested.
- Pictures in the monitor may be difficult to see in a bright light.
- Do not apply pressure to the monitor. The monitor could malfunction or suffer damage. Dust or lint on the monitor can be removed with a blower. Stains can be removed by wiping the monitor lightly with a soft cloth or chamois leather. Should the monitor break, care should be taken to avoid injury from broken glass. Be careful that liquid crystal from the monitor does not touch the skin or enter the eyes or mouth.
- Should you experience any of the following symptoms while framing shots in the viewfinder, discontinue use until your condition improves:
 - nausea, eye pain, eye fatigue,
 - dizziness, headache, stiffness in your neck or shoulders,
 - queasiness or loss of hand-eye coordination, or
 - motion sickness.
- The display may rapidly flicker on and off during burst photography. Watching the flickering display could cause you to feel unwell. Discontinue use until your condition improves.

• **Bright Lights and Back-Lit Subjects**

Noise in the form of lines may in rare cases appear in pictures that include bright lights or back-lit subjects.

Cautions: Using Batteries

• Precautions for Use

- If improperly handled, batteries may rupture or leak, causing the product to corrode. Observe the following precautions when handling batteries:
 - Turn the product off before replacing the battery.
 - Batteries may be hot after extended use.
 - Keep the battery terminals clean.
 - Use only batteries approved for use in this equipment.
 - Do not short or disassemble batteries or expose them to flame or excessive heat.
 - Replace the terminal cover when the battery is not inserted in the camera or charger.
- If the battery is hot, for example immediately after use, wait for it to cool before charging. Attempting to charge the battery while its internal temperature is elevated will impair battery performance, and the battery may not charge or charge only partially.
- If the battery will not be used for some time, remove it from the camera and store it in a cool, dry location with an ambient temperature of 15 °C to 25 °C (59 °F to 77 °F). Avoid hot or extremely cold locations.
- Batteries in long-term storage should be charged to about 50% at least once a year. Do not charge the battery to 100% before returning it to storage. A fully-exhausted battery will charge to around 50% in about half the time needed to charge it to 100%.
- Remove the battery from the camera or charger when not in use. The camera and charger draw minute amounts of charge even when off and could draw the battery down to the point that it will no longer function.
- Do not use the battery at ambient temperatures below -10 °C (14 °F) or above 40 °C (104 °F). Failure to observe this precaution could damage the battery or impair its performance. Charge the battery indoors at ambient temperatures of 5 °C–35 °C (41 °F–95 °F). The battery will not charge if its temperature is below 0 °C (32 °F) or above 60 °C (140 °F).
- Capacity may be reduced and charging times increase at battery temperatures from 0 °C (32 °F) to 15 °C (59 °F) and from 45 °C (113 °F) to 60 °C (140 °F).
- Batteries in general exhibit a drop in capacity at low ambient temperatures. Even fresh batteries charged at temperatures under about 5 °C (41 °F) may show a temporary increase from “0” to “1” in the setup menu **[Battery info]** age display, but the display will return to normal once the battery has been recharged at a temperature of about 20 °C (68 °F) or higher.
- Battery capacity drops at low temperatures. The change in capacity with temperature is reflected in the camera battery-level display. As a result, the battery display may show a drop in capacity as the temperature drops, even if the battery is fully charged.
- Batteries may be hot after use. Observe due caution when removing batteries from the camera.

- **Charge Batteries Before Use**

Charge the battery before use. The supplied battery is not fully charged at shipment.

- **Ready Spare Batteries**

Before taking photographs, ready a spare battery and keep it fully charged. Depending on your location, it may be difficult to purchase replacement batteries on short notice.

- **Have Fully-Charged Spare Batteries Ready on Cold Days**

Partially-charged batteries may not function on cold days. In cold weather, charge one battery before use and keep another in a warm place, ready to be exchanged as necessary. Once warmed, cold batteries may recover some of their charge.

- **Battery Level**

- Turning the camera on or off repeatedly when the battery is fully discharged will shorten battery life. Batteries that have been fully discharged must be charged before use.
- A marked drop in the time a fully charged battery retains its charge when used at room temperature indicates that it requires replacement. Purchase a new rechargeable battery.

- **Do Not Attempt to Charge Fully-Charged Batteries**

Continuing to charge the battery after it is fully charged can impair battery performance.

- **Recycling Used Batteries**

Recycle rechargeable batteries in accord with local regulations, being sure to first insulate the terminals with tape.

Cautions: Using the Charger

- Do not move the charger or touch the battery during charging; failure to observe this precaution could in very rare instances result in the charger showing that charging is complete when the battery is only partially charged. Remove and reinsert the battery to begin charging again.
- Do not short the charger terminals. Failure to observe this precaution could result in overheating and damage to the charger.
- Unplug the charger or disconnect the charging AC adapter when the charger is not in use.
- Use the MH-33 with compatible batteries only.
- Do not use chargers with damage that leaves the interior exposed or that produce unusual sounds when used.
- The symbols on this product represent the following:
⎓ DC

Cautions: Using the Charging AC Adapter

- Latch the battery chamber cover before charging the battery via the charging AC adapter.
- Do not move the camera or touch the battery during charging; failure to observe this precaution could in very rare instances result in the camera showing that charging is complete when the battery is only partially charged. Disconnect and reconnect the adapter to begin charging again.
- Do not short the adapter terminals. Failure to observe this precaution could result in overheating and damage to the adapter.
- Unplug the adapter when it is not in use.
- Do not use adapters with damage that leaves the interior exposed or that produce unusual sounds when used.
- The symbols on this product represent the following:
~ AC, ⎓ DC, □ Class II equipment (the construction of the product is double-insulated)

Specifications

Nikon Z 9 Digital Camera

Type	
Type	Digital camera with support for interchangeable lenses
Lens mount	Nikon Z mount
Lens	
Compatible lenses	<ul style="list-style-type: none">• Z mount NIKKOR lenses• F mount NIKKOR lenses (mount adapter required; restrictions may apply)
Effective pixels	
Effective pixels	45.7 million
Image sensor	
Type	35.9 × 23.9 mm CMOS sensor (Nikon FX format)
Total pixels	52.37 million
Dust-reduction system	Image sensor cleaning, Image Dust Off reference data (requires NX Studio)

Storage

Image size (pixels)	<ul style="list-style-type: none">• [FX (36 × 24)] selected for image area:<ul style="list-style-type: none">- 8256 × 5504 (Large: 45.4 M)- 6192 × 4128 (Medium: 25.6 M)- 4128 × 2752 (Small: 11.4 M)• [DX (24 × 16)] selected for image area:<ul style="list-style-type: none">- 5392 × 3592 (Large: 19.4 M)- 4032 × 2688 (Medium: 10.8 M)- 2688 × 1792 (Small: 4.8 M)• [1:1 (24 × 24)] selected for image area:<ul style="list-style-type: none">- 5504 × 5504 (Large: 30.3 M)- 4128 × 4128 (Medium: 17.0 M)- 2752 × 2752 (Small: 7.6 M)• [16:9 (36 × 20)] selected for image area:<ul style="list-style-type: none">- 8256 × 4640 (Large: 38.3 M)- 6192 × 3480 (Medium: 21.5 M)- 4128 × 2320 (Small: 9.6 M)
File format (image quality)	<ul style="list-style-type: none">• NEF (RAW): 14 bit; choose from lossless compression, high efficiency★, and high efficiency options• JPEG: JPEG-Baseline compliant with fine (approx. 1:4), normal (approx. 1:8), or basic (approx. 1:16) compression; size-priority and optimal-quality compression available• NEF (RAW) + JPEG: Single photograph recorded in both NEF (RAW) and JPEG formats
Picture Control System	Auto, Standard, Neutral, Vivid, Monochrome, Portrait, Landscape, Flat, Creative Picture Controls (Dream, Morning, Pop, Sunday, Somber, Dramatic, Silence, Bleached, Melancholic, Pure, Denim, Toy, Sepia, Blue, Red, Pink, Charcoal, Graphite, Binary, Carbon); selected Picture Control can be modified; storage for custom Picture Controls

Storage	
Media	CFexpress (Type B) and XQD memory cards
Dual card slots	The card in Slot 2 can be used for overflow or backup storage, for separate storage of NEF (RAW) and JPEG pictures, or for storage of duplicate JPEG pictures at different sizes and image qualities; pictures can be copied between cards.
File system	DCF 2.0, Exif 2.32
Viewfinder	
Viewfinder	1.27-cm/0.5-in. approx. 3690k-dot (Quad VGA) OLED electronic viewfinder with color balance and auto and 18-level manual brightness controls; high frame-rate display available
Frame coverage	Approx. 100% horizontal and 100% vertical
Magnification	Approx. 0.8× (50 mm lens at infinity, -1.0 m^{-1})
Eyepoint	23 mm (-1.0 m^{-1} ; from rearmost surface of viewfinder eyepiece lens)
Diopter adjustment	$-4 - +3 \text{ m}^{-1}$
Eye sensor	Automatically switches between monitor and viewfinder displays
Monitor	
Monitor	8-cm/3.2-in., approx. 2100k-dot vertically and horizontally tilting TFT touch-sensitive LCD with 170° viewing angle, approximately 100% frame coverage, and color balance and 15-level manual brightness controls

Shutter	
Type	Electronic shutter with shutter sound and sensor shield
Speed	$\frac{1}{32000}$ – 30 s (choose from step sizes of $\frac{1}{3}$, $\frac{1}{2}$, and 1 EV, extendable to 900 s in mode M), bulb, time
Flash sync speed	Flash synchronizes with shutter at speeds of $\frac{1}{250}$ or $\frac{1}{200}$ s or slower (but note that the guide number drops at speeds of $\frac{1}{200}$ to $\frac{1}{250}$ s); sync speeds as fast as $\frac{1}{8000}$ s are supported with auto FP high-speed sync
Release	
Release mode	Single frame, continuous low-speed, continuous high-speed, high-speed frame capture + with Pre-Release Capture, self-timer
Approximate frame advance rate	<ul style="list-style-type: none"> • Continuous low-speed: Approx. 1 – 10 fps • Continuous high-speed: Approx. 10 – 20 fps • High-speed frame capture + (C30): Approx. 30 fps • High-speed frame capture + (C60): Approx. 60 fps • High-speed frame capture + (C120): Approx. 120 fps <p>* Maximum frame advance rate as measured by in-house tests.</p>
Self-timer	2 s, 5 s, 10 s, 20 s; 1–9 exposures at intervals of 0.5, 1, 2, or 3 s

Exposure	
Metering system	TTL metering using camera image sensor
Metering mode	<ul style="list-style-type: none"> • Matrix metering • Center-weighted metering: Weight of 75% given to 12 or 8 mm circle in center of frame or weighting can be based on average of entire frame • Spot metering: Meters circle with a diameter of approximately 4 mm centered on selected focus point • Highlight-weighted metering
Range	<p>–3 – +17 EV</p> <p>* Figures are for ISO 100 and f/2.0 lens at 20 °C/68 °F</p>
Mode	P: programmed auto with flexible program, S: shutter-priority auto, A: aperture-priority auto, M: manual
Exposure compensation	–5 – +5 EV (choose from step sizes of $\frac{1}{3}$ and $\frac{1}{2}$ EV)
Exposure lock	Luminosity locked at detected value
ISO sensitivity (Recommended Exposure Index)	ISO 64–25600 (choose from step sizes of $\frac{1}{3}$ and 1 EV); can also be set to approx. 0.3, 0.7, or 1 EV (ISO 32 equivalent) below ISO 64 or to approx. 0.3, 0.7, 1, or 2 EV (ISO 102400 equivalent) above ISO 25600; auto ISO sensitivity control available
Active D-Lighting	Auto, Extra high 2, Extra high 1, High, Normal, Low, and Off
Multiple exposure	Add, average, lighten, darken
Other options	HDR overlay, photo mode flicker reduction, high-frequency flicker reduction

Autofocus	
Type	Hybrid phase-detection/contrast AF with AF assist
Detection range	<p>–7 – +19 EV (–9 – +19 EV with starlight view)</p> <p>* Measured in photo mode at ISO 100 and a temperature of 20 °C/68 °F using single-servo AF (AF-S) and a lens with a maximum aperture of f/1.2</p>
Lens servo	<ul style="list-style-type: none"> • Autofocus (AF): Single-servo AF (AF-S); continuous-servo AF (AF-C); full-time AF (AF-F; available only in video mode); predictive focus tracking • Manual focus (M): Electronic rangefinder can be used
Focus points	<p>493 focus points</p> <p>* Number of focus points available in photo mode with single-point AF selected for AF-area mode and FX selected for image area</p>
AF-area mode	Pinpoint (available in photo mode only), single-point, dynamic-area (S, M, and L; available in photo mode only), wide-area (S, L, C1, and C2), and auto-area AF; 3D-tracking (available in photo mode only); subject-tracking AF (available in video mode only)
Focus lock	Focus can be locked by pressing shutter-release button halfway (single-servo AF/ AF-S) or by pressing the center of the sub-selector
Vibration reduction (VR)	
Camera on-board VR	5-axis image sensor shift
Lens on-board VR	Lens shift (available with VR lenses)

Flash	
Flash control	TTL: i-TTL flash control; i-TTL balanced fill-flash is used with matrix, center-weighted, and highlight-weighted metering, standard i-TTL fill-flash with spot metering
Flash mode	Front-curtain sync, slow sync, rear-curtain sync, red-eye reduction, red-eye reduction with slow sync, off
Flash compensation	-3 – +1 EV (choose from step sizes of $\frac{1}{3}$ and $\frac{1}{2}$ EV)
Flash-ready indicator	Lights when optional flash unit is fully charged; flashes as underexposure warning after flash is fired at full output
Accessory shoe	ISO 518 hot-shoe with sync and data contacts and safety lock
Nikon Creative Lighting System (CLS)	i-TTL flash control, radio-controlled Advanced Wireless Lighting, optical Advanced Wireless Lighting, modeling illumination, FV lock, Color Information Communication, auto FP high-speed sync, unified flash control
Sync terminal	ISO 519 sync terminal with locking thread
White balance	
White balance	Auto (3 types), natural light auto, direct sunlight, cloudy, shade, incandescent, fluorescent (3 types), flash, choose color temperature (2500–10,000 K), preset manual (up to 6 values can be stored), all with fine-tuning
Bracketing	
Bracketing	Exposure and/or flash, white balance, and ADL

Video	
Metering system	TTL metering using camera image sensor
Metering mode	Matrix, center-weighted, or highlight-weighted
Frame size (pixels) and frame rate	<ul style="list-style-type: none"> • 7680 × 4320 (8K UHD): 30p (progressive)/25p/24p • 3840 × 2160 (4K UHD): 120p/100p/60p/50p/30p/25p/24p • 1920 × 1080: 120p/100p/60p/50p/30p/25p/24p <p>* Actual frame rates for 120p, 100p, 60p, 50p, 30p, 25p, and 24p are 119.88, 100, 59.94, 50, 29.97, 25, and 23.976 fps respectively</p>
Frame size (pixels) and frame rate (RAW video)	<ul style="list-style-type: none"> • 8256 × 4644: 60p/50p/30p/25p/24p • 5392 × 3032: 60p/50p/30p/25p/24p • 4128 × 2322: 120p/100p/60p/50p/30p/25p/24p • 3840 × 2160: 120p/100p/60p/50p <p>* Actual frame rates for 120p, 100p, 60p, 50p, 30p, 25p, and 24p are 119.88, 100, 59.94, 50, 29.97, 25, and 23.976 fps respectively</p>
File format	NEV, MOV, MP4
Video compression	N-RAW (12 bit), Apple ProRes RAW HQ (12 bit), Apple ProRes 422 HQ (10 bit), H.265/HEVC (8 bit/10 bit), H.264/AVC (8 bit)
Audio recording format	Linear PCM (48 KHz, 24 bit, for videos recorded in NEV or MOV format) or AAC (48 KHz, 16 bit, for videos recorded in MP4 format)
Audio recording device	Built-in stereo or external microphone with attenuator option; sensitivity adjustable
Exposure compensation	-3 – +3 EV (choose from step sizes of $\frac{1}{3}$ and $\frac{1}{2}$ EV)
ISO sensitivity (Recommended Exposure Index)	<ul style="list-style-type: none"> • Mode M: Manual selection (ISO 64–25600; choose from step sizes of $\frac{1}{6}$, $\frac{1}{3}$, and 1 EV); with additional options available equivalent to approximately 0.3, 0.7, 1, or 2 EV (ISO 102400 equivalent) above ISO 25600; auto ISO sensitivity control (ISO 64–Hi 2.0) available with selectable upper limit • Modes P, S, A: Auto ISO sensitivity control (ISO 64–Hi 2.0) with selectable upper limit
Active D-Lighting	Extra high, High, Normal, Low, and Off

Video	
Other options	Time-lapse video recording, electronic vibration reduction, time codes, N-Log and HDR (HLG) video, wave-form display, red REC frame indicator, video recording display zoom (50%, 100%, and 200%), extended shutter speeds (mode M), and dual-format (proxy-video) recording for RAW video; extended oversampling available; option to view video recording info available via z menu; Hi-Res Zoom
Playback	
Playback	Full-frame and thumbnail (up to 4, 9, or 72 pictures) playback with playback zoom, playback zoom cropping, video playback, slide shows, histogram display, highlights, photo information, location data display, auto picture rotation, picture rating, voice memo recording and playback, IPTC information embedding and display, filtered playback, skip to first shot in series, series playback, save consecutive frames, and motion blend
Interface	
USB	Type C USB connector (SuperSpeed USB); connection to built-in USB port is recommended
HDMI output	Type A HDMI connector
Audio input	Stereo mini-pin jack (3.5 mm diameter; plug-in power supported)
Audio output	Stereo mini-pin jack (3.5 mm diameter)
Ten-pin remote terminal	Built-in (can be used with MC-30A/MC-36A remote cords and other optional accessories)
Ethernet	<p>RJ-45 connector</p> <ul style="list-style-type: none"> • Standards: IEEE 802.3ab (1000BASE-T), IEEE 802.3u (100BASE-TX), IEEE 802.3 (10BASE-T) • Data rates *: 1000/100/10 Mbps with auto detect • Port: 1000BASE-T/100BASE-TX/10BASE-T (AUTO-MDIX) <p>* Maximum logical data rates according to IEEE standard; actual rates may differ.</p>

Wi-Fi/Bluetooth

Wi-Fi

- **Standards:**
 - IEEE 802.11b/g/n (Africa, Asia, and Oceania)
 - IEEE 802.11b/g/n/a/ac (Europe, U.S.A., Canada, Mexico)
 - IEEE 802.11b/g/n/a (other countries in the Americas)
- **Operating frequency:**
 - 2412–2462 MHz (channel 11; Africa, Asia, and Oceania)
 - 2412–2462 MHz (channel 11) and 5180–5825 MHz (U.S.A., Canada, Mexico)
 - 2412–2462 MHz (channel 11) and 5180–5805 MHz (other countries in the Americas)
 - 2412–2462 MHz (channel 11) and 5745–5805 MHz (Georgia)
 - 2412–2462 MHz (channel 11) and 5180–5320 MHz (other European countries)
- **Maximum output power (EIRP):**
 - 2.4 GHz band: 8.4 dBm
 - 5 GHz band: 6.0 dBm (Georgia)
 - 5 GHz band: 9.0 dBm (other countries)
- **Authentication:** Open system, WPA2-PSK, WPA3-SAE

Bluetooth

- **Communication protocols:** Bluetooth Specification version 5.0
- **Operating frequency:**
 - Bluetooth: 2402–2480 MHz
 - Bluetooth Low Energy: 2402–2480 MHz
- **Maximum output power (EIRP):**
 - Bluetooth: 2.9 dBm
 - Bluetooth Low Energy: 1.4 dBm

Range (line of sight)

Approximately 10 m (32 ft) *

* Without interference. Range may vary with signal strength and presence or absence of obstacles.

Location Data	
Supported GNS systems	GPS (USA), GLONASS (Russia), QZSS (Japan)
Data acquired	Latitude, longitude, altitude, UTC (Universal Coordinated Time)
Clock synchronization	Camera clock can be set to time acquired via GNSS
Track logs	NMEA-compliant
Log interval	15 s, 30 s, 1 min., 2 min., 5 min.
Maximum log recording time	6, 12, or 24 hours
Log deletion	Supported
Power source	
Battery	One EN-EL18d rechargeable Li-ion battery * * EN-EL18c, EN-EL18b, EN-EL18a, and EN-EL18 batteries can also be used. Note, however, that fewer pictures can be taken on a single charge than with the EN-EL18d. The EH-7P charging AC adapter can be used to charge EN-EL18d, EN-EL18c, and EN-EL18b batteries only.
Charging AC adapter	EH-7P charging AC adapter
AC adapter	EH-6d; requires EP-6a power connector (available separately)
Tripod socket	
Tripod socket	0.635 cm (1/4 in., ISO 1222)

Dimensions/weight	
Dimensions (W × H × D)	Approx. 149 × 149.5 × 90.5 mm/5.9 × 5.9 × 3.6 in.
Weight	Approx. 1340 g (2 lb. 15.3 oz.) with battery and memory card but without body cap and accessory shoe cover; approx. 1160 g/2 lb. 9 oz. (camera body only)
Operating environment	
Temperature	−10°C−40 °C (+14 °F−104 °F)
Humidity	85% or less (no condensation)

- Unless otherwise stated, all measurements are performed in conformity with Camera and Imaging Products Association (CIPA) standards or guidelines.
- All figures are for a camera with a fully-charged battery.
- The sample images displayed on the camera and the images and illustrations in this document are for expository purposes only.
- Nikon reserves the right to change the appearance and specifications of the hardware and software described in this document at any time and without prior notice. Nikon will not be held liable for damages that may result from any mistakes that this document may contain.

MH-33 Battery Charger

Rated input	DC 5 V/9 V, 3 A/3 A
Charging output	DC 12.6 V, 1.6 A
Supported batteries	EN-EL18d, EN-EL18c, and EN-EL18b rechargeable Li-ion batteries
Charging time	Approx. 4 hours (approx. 3 hours with EN-EL18c/EN-EL18b batteries) * Time required to charge battery at an ambient temperature of 25 °C (77 °F) when no charge remains
Operating temperature	0°C–40 °C (+32 °F–104 °F)
Dimensions (W × H × D)	Approx. 87 × 25 × 86.5 mm /3.5 × 1 × 3.5 in., excluding projections
Weight	Approx. 101 g/3.6 oz

The symbols on this product represent the following:

⎓ DC

EH-7P Charging AC Adapter

Rated input	AC 100–240 V, 50/60 Hz, MAX 0.5 A
Rated output	DC 5.0 V/3.0 A, 15.0 W
Supported batteries	EN-EL18d, EN-EL18c, and EN-EL18b rechargeable Li-ion batteries
Operating temperature	0°C–40 °C (+32 °F–104 °F)
Average active efficiency	81.80%
Efficiency at low load (10%)	72.50%
No-load power consumption	0.075 W
Dimensions (W × H × D)	Approx. 65.5 × 26.5 × 58.5 mm/2.6 × 1.1 × 2.4 in., excluding plug adapter
Weight	Approx. 135 g (4.8 oz), excluding plug adapter

The EH-7P comes with a plug adapter attached in countries or regions where required; the shape of the plug adapter varies with the country of sale. Do not attempt to remove the plug adapter, as this could damage the product.

The symbols on this product represent the following:

~ AC, = DC,  Class II equipment (the construction of the product is double-insulated)

Tip: Notice for Customers in Europe

Distributor (Importer for EU Countries)

Nikon Europe B.V.

The Garden, Stroombaan 14, 1181 VX Amstelveen, The Netherlands
+31-20-7099-000

Commercial registration number: 34036589

Importer UK: Nikon UK, Branch of Nikon Europe BV¹ with Chamber of
Commerce: BR022801

1 The Crescent, Surbiton, Surrey, KT6 4BN, United Kingdom



EN-EL18d Rechargeable Li-ion Battery

Type	Rechargeable lithium-ion battery
Rated capacity	10.8 V, 3300 mAh
Operating temperature	-10 °C–40 °C (+14 °F–104 °F) with Z 9
Dimensions (W × H × D)	Approx. 56.5 × 27 × 82.5 mm (2.3 × 1.1 × 3.3 in.)
Weight	Approx. 175 g (6.2 oz), excluding terminal cover

✔ Caution: Disposing of Data Storage Devices

Please note that deleting pictures or formatting memory cards or other data storage devices does not completely erase the original image data. Deleted files can sometimes be recovered from discarded storage devices using commercially available software, potentially resulting in the malicious use of personal image data. Ensuring the privacy of such data is the user's responsibility.

Before discarding a data storage device or transferring ownership to another person, erase all data using commercial deletion software, or format the device and then completely refill it with pictures containing no private information (for example, pictures of empty sky). Care should be taken to avoid injury when physically destroying data storage devices.

Before discarding the camera or transferring ownership to another person, you should also use the **[Reset all settings]** item in the camera setup menu to delete network settings and other personal information.

✔ Supported Standards

- **DCF Version 2.0:** The Design Rule for Camera File System (DCF) is a standard widely used in the digital camera industry to ensure compatibility among different makes of camera.
- **Exif Version 2.32:** The camera supports Exif (Exchangeable Image File Format for Digital Still Cameras) version 2.32, a standard introduced with the goal of improving the interoperability of printers and digital cameras, making it easier to produce high-quality prints. Information stored with photographs is used for optimal color reproduction when the images are output on Exif-compliant printers. See the printer documentation for details.
- **HDMI:** High-Definition Multimedia Interface is a standard for multimedia interfaces used in consumer electronics and AV devices. This standard ensures that audiovisual data and control signals can be transmitted to HDMI-compliant devices via a single cable connection.

Approved Memory Cards

- The camera can be used with CFexpress (Type B) and XQD memory cards.
- CFexpress or XQD cards with a maximum data transfer rate of at least 250 MB/s are recommended for high-speed frame capture +.
- CFexpress or XQD cards with a maximum data transfer rate of at least 45 MB/s (300×) are recommended for video recording and playback. CFexpress or XQD cards with a maximum data transfer rate of at least 250 MB/s are recommended for recording and playback of videos with a high frame size or rate. Slower speeds may result in recording or playback being interrupted.
- When choosing cards for use in card readers, be sure they are compatible with the device.
- Contact the manufacturer for information on features, operation, and limitations on use.

Memory Card Capacity

The following table shows buffer capacity and the approximate number of pictures that can be stored on a 325 GB¹ card at different image qualities ([📖 106](#)) and sizes ([📖 108](#)) when [FX (36 × 24)] is selected for [Choose image area]. Actual capacity varies with shooting conditions and the type of card.

Image quality	Image size	File size	Number of exposures remaining ²	Buffer capacity ^{2, 3}
NEF (RAW), lossless compression	—	Approx. 55.1 MB	3600 frames	79 frames
NEF (RAW), high efficiency★	—	Approx. 33.0 MB	8500 frames	685 frames
NEF (RAW), high efficiency	—	Approx. 22.0 MB	12,100 frames	Over 1000 frames
JPEG fine⁴	Large	Approx. 24.1 MB	10,400 frames	Over 1000 frames
	Medium	Approx. 14.3 MB	17,700 frames	
	Small	Approx. 7.0 MB	35,400 frames	
JPEG normal⁴	Large	Approx. 12.2 MB	20,600 frames	Over 1000 frames
	Medium	Approx. 7.2 MB	34,400 frames	
	Small	Approx. 3.6 MB	68,800 frames	
JPEG basic⁴	Large	Approx. 5.3 MB	39,900 frames	Over 1000 frames
	Medium	Approx. 3.4 MB	65,200 frames	
	Small	Approx. 1.9 MB	123,000 frames	

1 Figures are for a ProGrade Digital COBALT 1700R 325GB memory card (as of September 2021) with a NIKKOR Z 50mm f/1.8S lens mounted on the camera.

2 Number of pictures that can be saved to memory card or stored in memory buffer varies with scene recorded.

- 3 Maximum number of exposures that can be stored in memory buffer at ISO 100. May drop in some situations, including when:
- an optimal-compression ([★]) JPEG option is selected for [**Image quality**] or
 - [**ON**] is selected for [**Auto distortion control**].
- 4 Figures assume a size-priority option (an option not marked with [★]) is selected for [**Image quality**]. Selecting an optimal-compression ([★]) option increases file size; the number of images and buffer capacity drop accordingly.

Battery Endurance

The video footage or number of shots that can be recorded with a fully-charged EN-EL18d rechargeable Li-ion battery ¹ is given below ². Actual endurance varies with such factors as the condition of the battery, the interval between shots, and the options selected in the camera menus.

Photo Mode (Single Frame): Number of Shots ³

- **[Viewfinder only]** selected for monitor mode with:
 - **[ON]** selected for **[Energy saving (photo mode)]** in the setup menu: Approx. 740 shots
 - **[OFF]** selected for **[Energy saving (photo mode)]** in the setup menu: Approx. 700 shots
- **[Monitor only]** selected for monitor mode with:
 - **[ON]** selected for **[Energy saving (photo mode)]** in the setup menu: Approx. 770 shots
 - **[OFF]** selected for **[Energy saving (photo mode)]** in the setup menu: Approx. 740 shots

Photo Mode (Burst Photography): Number of Shots ⁴

Approx. 5310 shots

Video Mode: Length of Footage ⁵

- **[Viewfinder only]** selected for monitor mode: Approx. 170 minutes
- **[Monitor only]** selected for monitor mode: Approx. 170 minutes

Actions such as the following can reduce battery endurance:

- keeping the shutter-release button pressed halfway,
- repeated autofocus operations,
- taking NEF (RAW) photographs,
- slow shutter speeds,
- using camera Wi-Fi (wireless LAN) and Bluetooth features,
- using the built-in GNSS receiver,
- using the camera with optional accessories connected,
- repeatedly zooming in and out, and
- taking pictures at low ambient temperatures.

To ensure that you get the most from rechargeable Nikon EN-EL18d batteries:

- Keep the battery contacts clean. Soiled contacts can reduce battery performance.
- Use batteries immediately after charging. Batteries will lose their charge if left unused.

- 1 EN-EL18c, EN-EL18b, EN-EL18a, and EN-EL18 batteries can also be used. Note, however, that fewer pictures can be taken on a single charge than with the EN-EL18d.
- 2 Measured at 23 °C/73.4 °F (± 2 °C/3.6 °F) with a SONY CEB-G128 memory card.
- 3 Camera and Imaging Products Association (CIPA) standard. One photograph taken at default settings once every 30 s. Measured with a NIKKOR Z 24–70mm f/4 S lens.
- 4 In-house measurements. Image quality set to JPEG normal, image size to "Large", shutter speed to $\frac{1}{250}$ s, shutter-release button pressed halfway for 3 s and focus cycled from infinity to minimum range three times before a burst of six shots, after which the viewfinder is turned on for 5 s and then turned off and the standby timer allowed to expire. This process is then repeated. Measured with a NIKKOR Z 70–200mm f/2.8 VR S lens. [**Viewfinder only**] was selected for monitor mode.
- 5 Actual battery endurance as measured under conditions specified by CIPA. Measured with a NIKKOR Z 24–70mm f/4 S lens. Measurement performed at default settings.
 - Each shot can be up to 125 minutes in length.
 - If camera temperature rises, recording may end before maximum length or size is reached.

Trademarks and Licenses

- CFexpress is a trademark of the CompactFlash Association in the United States and other countries.
- NVM Express is a trademark or registered trademark of NVM Express Inc.
- XQD is a trademark of Sony Corporation.
- Windows is either a registered trademark or a trademark of Microsoft Corporation in the United States and/or other countries.
- Apple®, App Store®, the Apple logos, iPhone®, iPad®, Mac, and macOS are trademarks of Apple Inc. registered in the U.S. and/or other countries.
- Android, Google Play and the Google Play logo are trademarks of Google LLC. The Android robot is reproduced or modified from work created and shared by Google and used according to terms described in the Creative Commons 3.0 Attribution License.
- IOS is a trademark or registered trademark of Cisco Systems, Inc., in the United States and/or other countries and is used under license.
- HDMI, the HDMI logo and High-Definition Multimedia Interface are trademarks or registered trademarks of HDMI Licensing, LLC.

HDMI

- The Bluetooth® word mark and logo are registered trademarks owned by Bluetooth SIG, Inc., and any use of such marks by Nikon is under license.
- Wi-Fi and the Wi-Fi logo are trademarks or registered trademarks of the Wi-Fi Alliance.
- Powered by intoPIX technology.



- All other trade names mentioned in this document or the other documentation provided with your Nikon product are trademarks or registered trademarks of their respective holders.
- Use of the Made for Apple badge means that an accessory has been designed to connect specifically to the Apple products identified in the badge, and has been certified by the developer to meet Apple performance standards. Apple is not responsible for the operation of this device or its compliance with safety and regulatory standards. Please note that the use of this accessory with an Apple product may affect wireless performance.
- This product includes software developed by the OpenSSL Project for use in the OpenSSL Toolkit.

✔ **FreeType License (FreeType2)**

Portions of this software are copyright © 2012 The FreeType Project (<https://www.freetype.org>). All rights reserved.

✔ **MIT License (HarfBuzz)**

Portions of this software are copyright © 2018 The HarfBuzz Project (<https://www.freedesktop.org/wiki/Software/HarfBuzz>). All rights reserved.

IN NO EVENT SHALL THE COPYRIGHT HOLDER BE LIABLE TO ANY PARTY FOR DIRECT, INDIRECT, SPECIAL, INCIDENTAL, OR CONSEQUENTIAL DAMAGES ARISING OUT OF THE USE OF THIS SOFTWARE AND ITS DOCUMENTATION, EVEN IF THE COPYRIGHT HOLDER HAS BEEN ADVISED OF THE POSSIBILITY OF SUCH DAMAGE. THE COPYRIGHT HOLDER SPECIFICALLY DISCLAIMS ANY WARRANTIES, INCLUDING, BUT NOT LIMITED TO, THE IMPLIED WARRANTIES OF MERCHANTABILITY AND FITNESS FOR A PARTICULAR PURPOSE. THE SOFTWARE PROVIDED HEREUNDER IS ON AN "AS IS" BASIS, AND THE COPYRIGHT HOLDER HAS NO OBLIGATION TO PROVIDE MAINTENANCE, SUPPORT, UPDATES, ENHANCEMENTS, OR MODIFICATIONS.

✔ **Unicode® Character Database License (Unicode® Character Database)**

The software for this product uses the Unicode® Character Database License open-source software. The terms of the software license are as follows:

COPYRIGHT AND PERMISSION NOTICE

Copyright © 1991-2020 Unicode, Inc. All rights reserved.

Distributed under the Terms of Use in
<https://www.unicode.org/copyright.html>.

Permission is hereby granted, free of charge, to any person obtaining a copy of the Unicode data files and any associated documentation (the "Data Files") or Unicode software and any associated documentation (the "Software") to deal in the Data Files or Software without restriction, including without limitation the rights to use, copy, modify, merge, publish, distribute, and/or sell copies of the Data Files or Software, and to permit persons to whom the Data Files or Software are furnished to do so, provided that either

- (i) this copyright and permission notice appear with all copies of the Data Files or Software, or
- (ii) this copyright and permission notice appear in associated Documentation.

THE DATA FILES AND SOFTWARE ARE PROVIDED "AS IS", WITHOUT WARRANTY OF ANY KIND, EXPRESS OR IMPLIED, INCLUDING BUT NOT LIMITED TO THE WARRANTIES OF MERCHANTABILITY, FITNESS FOR A PARTICULAR PURPOSE AND NONINFRINGEMENT OF THIRD PARTY RIGHTS. IN NO EVENT SHALL THE COPYRIGHT HOLDER OR HOLDERS INCLUDED IN THIS NOTICE BE LIABLE FOR ANY CLAIM, OR ANY SPECIAL INDIRECT OR CONSEQUENTIAL DAMAGES, OR ANY DAMAGES WHATSOEVER RESULTING FROM LOSS OF USE, DATA OR PROFITS, WHETHER IN AN ACTION OF CONTRACT, NEGLIGENCE OR OTHER TORTIOUS ACTION, ARISING OUT OF OR IN CONNECTION WITH THE USE OR PERFORMANCE OF THE DATA FILES OR SOFTWARE.

Except as contained in this notice, the name of a copyright holder shall not be used in advertising or otherwise to promote the sale, use or other dealings in these Data Files or Software without prior written authorization of the copyright holder.

AVC Patent Portfolio License

THIS PRODUCT IS LICENSED UNDER THE AVC PATENT PORTFOLIO LICENSE FOR THE PERSONAL AND NON-COMMERCIAL USE OF A CONSUMER TO (i) ENCODE VIDEO IN COMPLIANCE WITH THE AVC STANDARD ("AVC VIDEO") AND/OR (ii) DECODE AVC VIDEO THAT WAS ENCODED BY A CONSUMER ENGAGED IN A PERSONAL AND NON-COMMERCIAL ACTIVITY AND/OR WAS OBTAINED FROM A VIDEO PROVIDER LICENSED TO PROVIDE AVC VIDEO. NO LICENSE IS GRANTED OR SHALL BE IMPLIED FOR ANY OTHER USE. ADDITIONAL INFORMATION MAY BE OBTAINED FROM MPEG LA, L.L.C. SEE

<https://www.mpegla.com>

BSD License (NVM Express Driver)

The license for the open-source software included in the camera's NVM Express driver is as follows:

<https://imaging.nikon.com/support/pdf/LicenseNVMe.pdf>

Other Open-Source Software

Additional open-source licenses can be found at the URL below:

<https://imaging.nikon.com/oss/en/index.htm>

Cautions: Location Data (GPS/GLONASS)

• Location Data and Track Logs

- If **[ON]** is selected for **[Location data (built-in)]** > **[Record location data]** in the setup menu or log tracking is in progress, the camera will continue to acquire log and/or location even while off.
- Personal information may be inferred from the location data stored in track logs or embedded in photos and videos. Exercise caution when sharing photos, videos, or track logs or when posting them to the Internet or other locations where they can be viewed by third parties. Be sure to also read "Caution: Disposing of Data Storage Devices" ([📖 919](#)).

• Navigation

This product is a camera. It is not intended for use as a navigation or surveying device.

- The location reported by the camera is an approximation only. It is not to be used for surveying or for navigation when travelling by air or car, on foot, or by other means.

• Overseas Use

- Before travelling, check with your travel agent or the embassy or tourism board of the countries you will be visiting for information on restrictions that may apply to the use of cameras that support the recording of location data. China, for example, prohibits unauthorized recording of location data. Select **[OFF]** for **[Record location data]**.
- As of October, 2021, the location data function may not perform as expected in China and in the vicinity of the Chinese border.

Notices

- **Notices for Customers in the U.S.A.**

The Battery Charger

IMPORTANT SAFETY INSTRUCTIONS—SAVE THESE INSTRUCTIONS
DANGER—TO REDUCE THE RISK OF FIRE OR ELECTRIC SHOCK, CAREFULLY FOLLOW THESE INSTRUCTIONS

Federal Communications Commission (FCC) Radio Frequency Interference Statement

This device complies with part 15 of the FCC Rules. Operation is subject to the following two conditions: (1) This device may not cause harmful interference, and (2) this device must accept any interference received, including interference that may cause undesired operation.

Note: This equipment has been tested and found to comply with the limits for a Class B digital device, pursuant to Part 15 of the FCC rules. These limits are designed to provide reasonable protection against harmful interference in a residential installation. This equipment generates, uses, and can radiate radio frequency energy and, if not installed and used in accordance with the instructions, may cause harmful interference to radio communications. However, there is no guarantee that interference will not occur in a particular installation. If this equipment does cause harmful interference to radio or television reception, which can be determined by turning the equipment off and on, the user is encouraged to try to correct the interference by one or more of the following measures:

- Reorient or relocate the receiving antenna.
- Increase the separation between the equipment and receiver.
- Connect the equipment into an outlet on a circuit different from that to which the receiver is connected.
- Consult the dealer or an experienced radio/TV technician for help.

CAUTIONS

Modifications

The FCC requires the user to be notified that any changes or modifications made to this device that are not expressly approved by Nikon Corporation may void the user's authority to operate the equipment.



Interface Cables

Use the interface cables sold or provided by Nikon for your equipment. Using other interface cables may exceed the limits of Class B Part 15 of the FCC rules.

Nikon Inc., 1300 Walt Whitman Road, Melville,
New York 11747-3064, U.S.A.Tel.: 631-547-4200

- **Notice for Customers in Canada**

CAN ICES-3 B / NMB-3 B

• Notices for Customers in Europe

CAUTION: RISK OF EXPLOSION IF BATTERY IS REPLACED BY AN INCORRECT TYPE. DISPOSE OF USED BATTERIES ACCORDING TO THE INSTRUCTIONS.

This symbol indicates that electrical and electronic equipment is to be collected separately.

The following apply only to users in European countries:

- This product is designated for separate collection at an appropriate collection point. Do not dispose of as household waste.
- Separate collection and recycling helps conserve natural resources and prevent negative consequences for human health and the environment that might result from incorrect disposal.
- For more information, contact the retailer or the local authorities in charge of waste management.



This symbol on the battery indicates that the battery is to be collected separately.

The following apply only to users in European countries:

- All batteries, whether marked with this symbol or not, are designated for separate collection at an appropriate collection point. Do not dispose of as household waste.
- For more information, contact the retailer or the local authorities in charge of waste management.



Bluetooth and Wi-Fi (Wireless LAN)

This product is controlled by the United States Export Administration Regulations (EAR). The permission of the United States government is not required for export to countries other than the following, which as of this writing are subject to embargo or special controls: Cuba, Iran, North Korea, Sudan, and Syria (list subject to change).

The use of wireless devices may be prohibited in some countries or regions. Familiarize yourself with and obey all applicable local regulations.

The Bluetooth transmitter in this device operates in the 2.4 GHz band.

• Notice for Customers in the U.S.A. and Canada

This device complies with part 15 of FCC Rules and Innovation, Science and Economic Development Canada's licence-exempt RSSs. Operation is subject to the following two conditions: (1) this device may not cause harmful interference, and (2) this device must accept any interference received, including interference that may cause undesired operation.

FCC WARNING

The FCC requires the user to be notified that any changes or modifications made to this device that are not expressly approved by Nikon Corporation may void the user's authority to operate the equipment.

Compliance with FCC requirement 15.407(c)

Data transmission is always initiated by software, which is then passed down through the MAC, through the digital and analog baseband, and finally to the RF chip. Several special packets are initiated by the MAC. These are the only ways the digital baseband portion will turn on the RF transmitter, which it then turns off at the end of the packet. Therefore, the transmitter will be on only while one of the aforementioned packets is being transmitted. In other words, this device automatically discontinues transmission in case of either absence of information to transmit or operational failure.

Frequency Tolerance: ± 20 ppm

FCC Radio Frequency Interference Statement

Note: This equipment has been tested and found to comply with the limits for a Class B digital device, pursuant to part 15 of the FCC Rules. These limits are designed to provide reasonable protection against harmful interference in a residential installation. This equipment generates, uses and can radiate radio frequency energy and, if not installed and used in accordance with the instructions, may cause harmful interference to radio communications. However, there is no guarantee that interference will not occur in a particular installation. If this equipment does cause harmful interference to radio or television reception, which can be determined by turning the equipment off and on, the user is encouraged to try to correct the interference by one or more of the following measures:

- Reorient or relocate the receiving antenna.
- Increase the separation between the equipment and receiver.
- Connect the equipment into an outlet on a circuit different from that to which the receiver is connected.
- Consult the dealer or an experienced radio/TV technician for help.

Co-location

This transmitter must not be co-located or operated in conjunction with any other antenna or transmitter.

Nikon Inc., 1300 Walt Whitman Road, Melville, New York 11747-3064, U.S.A.

Tel.: 631-547-4200

FCC/ISED RF Exposure Statement

The available scientific evidence does not show that any health problems are associated with using low power wireless devices. There is no proof, however, that these low power wireless devices are absolutely safe. Low power Wireless devices emit low levels of radio frequency energy (RF) in the microwave range while being used. Whereas high levels of RF can produce health effects (by heating tissue), exposure of low-level RF that does not produce heating effects causes no known adverse health effects. Many studies of low-level RF exposures have not found any biological effects. Some studies have suggested that some biological effects might occur, but such findings have not been confirmed by additional research. This product has been tested and found to comply with FCC/ISED radiation exposure limits set forth for an uncontrolled environment and meets the FCC radio frequency (RF) Exposure Guidelines and RSS-102 of the ISED radio frequency (RF) Exposure rules. Please refer to the SAR test report that was uploaded to FCC website.

Compliance with RSS-247 Issue 2 §6.4

Data transmission is always initiated by software, which is then passed down through the MAC, through the digital and analog baseband, and finally to the RF chip. Several special packets are initiated by the MAC. These are the only ways the digital baseband portion will turn on the RF transmitter, which it then turns off at the end of the packet. Therefore, the transmitter will be on only while one of the aforementioned packets is being transmitted. In other words, this device automatically discontinues transmission in case of either absence of information to transmit or operational failure.

• Notice for Customers in Canada

For indoor use only (5150-5350MHz).

• Notice for Customers in Europe and in Countries Complying with the Radio Equipment Directive

Hereby, Nikon Corporation declares that the radio equipment type Z 9 is in compliance with Directive 2014/53/EU.



The full texts of the EU declarations of conformity are available at the following internet addresses:

https://imaging.nikon.com/support/pdf/DoC_N2014.pdf

Wi-Fi

- Operating frequency:
 - 2412–2462 MHz (channel 11; Africa, Asia, and Oceania)
 - 2412–2462 MHz (channel 11) and 5180–5825 MHz (U.S.A., Canada, Mexico)
 - 2412–2462 MHz (channel 11) and 5180–5805 MHz (other countries in the Americas)
 - 2412–2462 MHz (channel 11) and 5745–5805 MHz (Georgia)
 - 2412–2462 MHz (channel 11) and 5180–5320 MHz (other European countries)
- Maximum output power (EIRP):
 - 2.4 GHz band: 8.4 dBm
 - 5 GHz band: 6.0 dBm (Georgia)
 - 5 GHz band: 9.0 dBm (other countries)

Bluetooth

- Operating frequency:
 - Bluetooth: 2402–2480 MHz
 - Bluetooth Low Energy: 2402–2480 MHz
- Maximum output power (EIRP):
 - Bluetooth: 2.9 dBm
 - Bluetooth Low Energy: 1.4 dBm

● **Notice for Customers in Singapore**

Trade Name: ***Nikon***
Model: Z 9

This device complies with radio-frequency regulations. The content of certification labels not affixed to the device is given below.

**Complies with
IMDA Standards
DA103423**

● **Notice for Customers in Nigeria**

**Connection and use of this communications
equipment is permitted by the Nigerian
Communications Commission**

● **Security**

Although one of the benefits of this product is that it allows others to freely connect for the wireless exchange of data anywhere within its range, the following may occur if security is not enabled:

- **Data theft:** Malicious third-parties may intercept wireless transmissions to steal user IDs, passwords, and other personal information.
- **Unauthorized access:** Unauthorized users may gain access to the network and alter data or perform other malicious actions. Note that due to the design of wireless networks, specialized attacks may allow unauthorized access even when security is enabled.
- **Unsecured networks:** Connecting to open networks may result in unauthorized access. Use secure networks only.

Tip: Conformity Marking

The standards with which the camera complies can be viewed using the [Conformity marking] option in the setup menu.

Tip: Certificates**• Maroc/**

المغرب

AGREE PAR L'ANRT MAROC Numéro d'agrément : MR00029511ANRT2021
--

**• México**

La operación de este equipo está sujeta a las siguientes dos condiciones:

- (1) es posible que este equipo o dispositivo no cause interferencia perjudicial y
- (2) este equipo o dispositivo debe aceptar cualquier interferencia, incluyendo la que pueda causar su operación no deseada.

• Paraguay**Emap S.A. (Casa Nissei)**

Avda Adrian Jara, Esq. Regimiento Piribebuy, Ciudad del Este, Paraguay.

Tel: 595 61 500 115

Fax: 595 61 500 115

• ประเทศไทย

เครื่องโทรคมนาคมและอุปกรณ์นี้ มีความสอดคล้องตามมาตรฐานหรือข้อกำหนดทางเทคนิคของ กสทช

• عُمان

Oman-TRA
D090024
TRA/TA-R/11808/21

Z 9 Model Name: N2014

Changes with “C” Firmware Version 4.00

Features Available with “C” Firmware Version 4.00

The *Z 9 Reference Guide* is for “C” firmware version 3.00 (the latest version of the *Z 9 Reference Guide* is available from the Nikon Download Center). This chapter details the new features and changes introduced with camera “C” firmware version 4.00. The two documents are to be read together.

“Firmware Version”

To view the camera firmware version or update the camera firmware, select [**Firmware version**] in the setup menu.

Updates can be performed using a computer or smart device.

- **Computer:** Check the Nikon Download Center for new versions of the camera firmware. Information on performing updates is available via the firmware download page. <https://downloadcenter.nikonimglib.com/>
- **Smart device:** If the smart device has been paired with the camera using the SnapBridge app, the app will automatically notify you when updates become available, and you can then download the update to the camera memory card via the smart device. For information on performing updates, see SnapBridge online help. Note that automatic notifications may not be displayed at exactly the same time as the updates are made available on the Nikon Download Center.

Changes Made with “C” Firmware Version 4.00

The features added or updated with camera “C” firmware version 4.00 are summarized below. More information is available on the pages listed. For information on the menu items and defaults for “C” firmware version 4.00, see ‘Menu Items and Defaults for “C” Firmware Version 4.00’ ([📖 998](#)).

Still Photography

- New Bracketing Increments ([📖 940](#))
- More Time for Pre-Release Capture ([📖 941](#))
- New Large Size Option for JPEG + JPEG Recording ([📖 942](#))
- New Menu Item: “Auto Capture” ([📖 943](#))

Video Recording

- New Menu Item: “Auto Capture” ([📖 943](#))
- Low ISO Sensitivity Settings for N-Log Video ([📖 961](#))
- New Options for Hi-Res Zoom Speed ([📖 962](#))
- New: Slow-Motion Videos ([📖 963](#))

Playback

- Changes to **i**-Menu “Select for Upload” Options ([📖 965](#))
- “Priority Upload” Options Added to **i** Menu ([📖 966](#))

Controls

- Support for Power Zoom ([📖 967](#))
- New Custom Setting: d6 “Exposure Delay Mode” ([📖 969](#))
- New Options for Custom Settings f2 “Custom Controls (Shooting)” and g2 “Custom Controls” ([📖 970](#))
- New Options for Custom Setting f3 “Custom Controls (Playback)” ([📖 972](#))
- Updates to “Non-CPU Lens Data” ([📖 974](#))
- Increased Character Limit for IPTC “Category” Entries ([📖 975](#))
- New Shutter Sound and Volume Options ([📖 976](#))

Displays

- Support for “Viewfinder Display Size” Selection in Video Mode ([📖 977](#))
- Updated Distance Display for Manual Focus ([📖 978](#))

Networks

- Changes and Additions to “Connect to FTP Server” ([📖 979](#))
- Changes to Synchronized Release ([📖 980](#))
- New “Overwrite Copyright Info” Option for Master Cameras ([📖 997](#))

New Bracketing Increments

New options are available to the bracketing increments when **[AE & flash bracketing]**, **[AE bracketing]**, or **[Flash bracketing]** is selected for **[Auto bracketing]** > **[Auto bracketing set]** in the photo shooting menu.

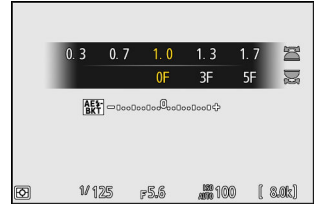
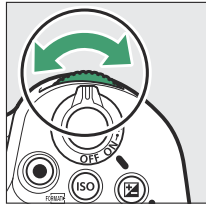
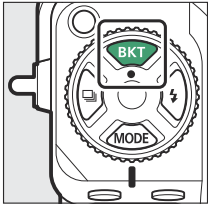

- Increments of 1.3, 1.7, 2.3, and 2.7 EV have been added to options available when $\frac{1}{3}$ step is selected for Custom Setting b2 **[EV steps for exposure cntrl]**.
- Increments of 1.5 and 2.5 EV have been added to options available when $\frac{1}{2}$ step is selected for Custom Setting b2 **[EV steps for exposure cntrl]**.
- Bracketing programs with increments of 2.0 EV or more offer a maximum of 5 shots.

Tip: Exposure Bracketing and Interval-Timer Photography

These new options have also been added to the bracketing increments available for **[Interval timer shooting]** > **[Options]** > **[AE bracketing]** in the photo shooting menu.

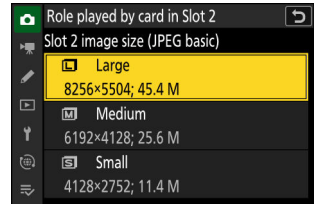

New Large Size Option for JPEG + JPEG Recording

[Large] has been added to the size options available for copies recorded to the memory card in Slot 2 when [JPEG Slot 1 - JPEG Slot 2] is selected for [Role played by card in Slot 2] in the photo shooting menu. The size can be selected by pressing  when [JPEG Slot 1 - JPEG Slot 2] is highlighted.



New Menu Item: “Auto Capture”

[Auto capture] items have been added to the photo shooting and video recording menus. These items are used to shoot bursts or record video automatically when the camera detects that the subject meets certain conditions, for example that it is in the frame, within a certain range of distances, and moving in a certain direction. They can even help photographers take photographs or record videos automatically without being present.

Option	Description
[Start]	Display auto capture settings and adjust auto capture criteria. After reviewing the selected criteria in the settings confirmation dialog to determine whether they will behave as predicted, press the video-record button to initiate auto capture.
[Select user preset]	<ul style="list-style-type: none">• Auto capture criteria can be saved to user presets [User preset 1] through [User preset 5]. Highlighting a preset and pressing  displays a menu where you can rename the preset and view settings or copy them to another preset.<ul style="list-style-type: none">- [View settings]: View the settings in the selected preset.- [Rename]: Rename the preset. Preset names can be up to 19 characters long.- [Copy]: Highlight the destination and press  to copy settings to the selected preset.• To immediately initiate auto capture using the criteria in a previously-saved preset, select the preset then choose [Start].

The Auto Capture Settings Display

The auto capture settings display can be viewed by selecting **[Start]** for **[Auto capture]** in the photo shooting or video recording menu. Highlight items and press **Ⓜ** to display options for the selected item.

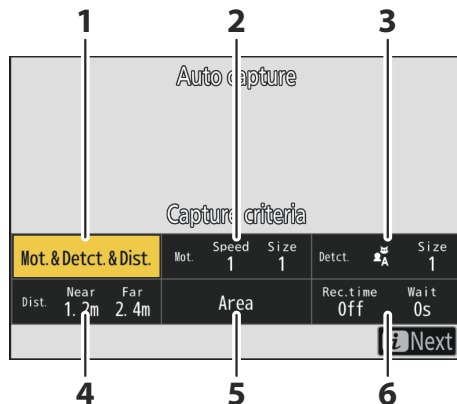

- 1** [Capture criteria]
- 2** [Advanced: Motion]
- 3** [Advanced: Subject detection]
- 4** [Advanced: Distance]
- 5** [Target area]
- 6** [Timing options]

Option	Description
[Capture criteria]	<ul style="list-style-type: none"> • Adjust auto capture criteria. <ul style="list-style-type: none"> - [Motion]: Select <input checked="" type="checkbox"/> this option to include the direction the subject is moving as one of the criteria that must be satisfied to trigger the start of auto capture shooting. - [Subject detection]: Select <input checked="" type="checkbox"/> this option to include detection of a subject as one of the criteria that must be satisfied to trigger the start of auto capture shooting. - [Distance]: If this option is selected <input checked="" type="checkbox"/>, shooting will continue while the subject is within the specified range of distances. • Auto capture will be triggered only if all the selected criteria are satisfied.
[Advanced: Motion]	<p>This option will take effect only if [Motion] is selected <input checked="" type="checkbox"/> for [Capture criteria]. It is used to choose the direction of motion, size, and speed of subjects that will trigger auto capture (📖 953).</p>

Option	Description
[Advanced: Subject detection]	This option will take effect only if [Subject detection] is selected (☑) for [Capture criteria] . It is used to choose the type and size of subjects that will trigger auto capture (📖 956).
[Advanced: Distance]	This option will take effect only if [Distance] is selected (☑) for [Capture criteria] . It is used to choose the range of distances at which the presence of a subject will trigger auto capture (📖 958). Shooting will continue while the subject is within the specified range of distances.
[Target area]	Choose the focus points used for subject detection when [Auto-area AF] is selected for AF-area mode. Auto capture will be triggered if a subject that meets the trigger conditions is detected in any of the selected focus points. Target-area selection can be used to disable focus points in areas of the frame that are blocked by obstacles or can otherwise be ignored for purposes of subject detection, ensuring that the desired subject can be detected more reliably.
[Timing options]	<p>Choose values for [Recording time selection] and [Wait after shooting].</p> <ul style="list-style-type: none"> • [Recording time selection]: Choose how long the camera will shoot once auto capture is triggered. Shooting will continue for the selected time even if the trigger conditions are no longer met. <ul style="list-style-type: none"> - Depending on camera settings, shooting may end before the expiration of the selected time. • [Wait after shooting]: Choose the minimum time the camera will wait after a burst. Once the burst is complete, shooting will pause for the selected duration even if the trigger conditions are met.

Taking Pictures Using Auto Capture

✓ Before Shooting

To ensure that shooting is not interrupted, use a fully-charged battery, the supplied charging AC adapter, or an optional AC adapter and power connector.

1 Mount the camera on a tripod or take other steps to hold it steady.

Fix the camera in place after framing the shot.

Tip: Framing the Shot

We recommend that you choose a wider angle than usual until you have grown used to auto capture.

2 Select the desired mode (photo or video) using the photo/video selector.

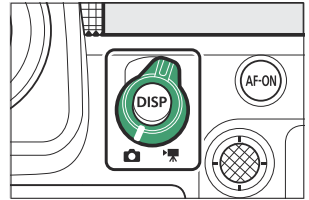

3 If you are using auto capture for photographs, select a continuous release mode: [Continuous high-speed], [Continuous low-speed], [C30], or [C120].

- If you are using auto capture to record videos, proceed to Step 4.
- If single-frame or self-timer mode is selected, the camera will temporarily switch to continuous high-speed mode when auto capture begins.
- If [C60] is selected, the release mode will change to [C120].
- If you selected continuous low-speed or continuous high-speed mode, choose the frame advance rate before proceeding.



4 Position the focus point.

Choose an AF-area mode and position the focus point in the area of the frame in which you anticipate the subject will appear.

- If autofocus is enabled, the camera will temporarily switch to focus mode **AF-C** during auto capture.
- If [**Auto-area AF**] is selected for AF-area mode, the actual frame rate drops to 15 fps when a frame advance rate of 20 fps is selected in continuous high-speed mode.
- When using manual focus, slide the lens focus-mode switch to [**M**] and adjust focus manually. Manual focus is available only with lenses equipped with a focus-mode switch.

5 Highlight [Auto capture] in the photo shooting or video recording menu and press \odot .

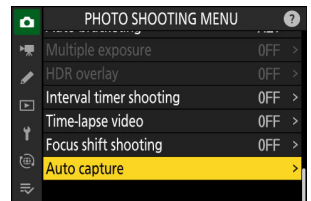

6 Choose [Select user preset], then highlight a destination preset for the auto capture settings and press \odot .

Choose a destination from presets [**User preset 1**] through [**User preset 5**].

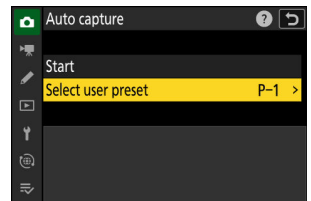

7 Highlight [Start] and press \odot .

Auto capture settings will be displayed.

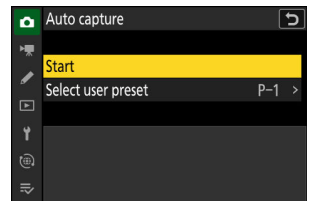

8 Highlight [Capture criteria] and press \odot .

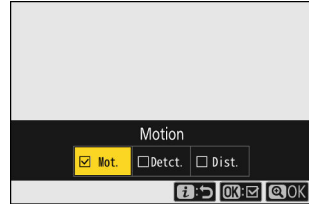
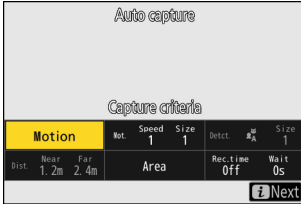

- Adjust auto capture criteria. Highlight options and press \odot to select () or deselect ().
- Press \odot to save changes and return to the auto capture settings display.

9 Adjust settings for each of the criteria selected for [Capture criteria].

- For information on the criteria available when [Motion] is enabled (), see *"Capture Criteria" > "Motion"* ([📖 953](#)).
- For information on the criteria available when [Subject detection] is enabled (), see *"Capture Criteria" > "Subject Detection"* ([📖 956](#)).
- For information on the criteria available when [Distance] is enabled (), see *"Capture Criteria" > "Distance"* ([📖 958](#)).
- Although multiple [Capture criteria] can be used together, we recommend that you enable () only one criterion at a time until you have grown used to auto capture.

10 Highlight [Target area] and press **OK**.

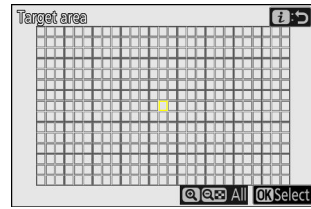
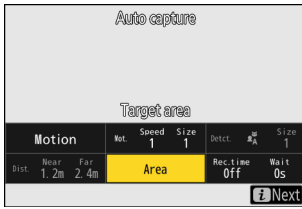

- Choose the focus points used for subject detection when **[Auto-area AF]** is selected for AF-area mode. Target-area selection is not available in other AF-area modes. If another mode is selected, proceed to Step 11.
- Target-area selection can be used to disable focus points in areas of the frame that are blocked by obstacles or can otherwise be ignored for purposes of subject detection, ensuring that the desired subject can be detected more reliably.
- Press **OK** to prevent focus points being used for subject detection (disabled focus points are displayed in red). Press **OK** again to clear (re-enable) the focus point.
- Press **Q** to enable all focus points.
- Press **Q(?)** to disable all focus points.
- Focus points can be enabled and disabled nine at a time (in 3 × 3 grids) by tapping the monitor.
- Press **i** to save changes and return to the auto capture settings display.

✓ Disabled Focus Points

Subjects meeting the **[Capture criteria]** will be detected only in the vicinity of the chosen focus points. For example, the camera will ignore motion in disabled focus points even when **[Motion]** is enabled (**✓**).

11 Highlight [Timing options] and press **OK**.

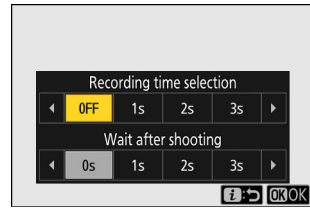
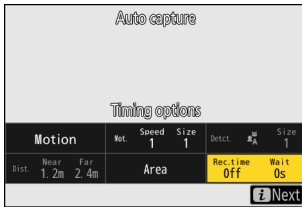

- Use **[Recording time selection]** to choose the length of each individual burst or video recording; options include **[OFF]** (no limit) and values of from 1 second to 30 minutes. When an option other than **[OFF]** is selected, shooting will continue for the selected time even if the trigger conditions are no longer met.
- The minimum length of time the camera will wait before beginning shooting again can be selected using **[Wait after shooting]**, which offers a choice of values of from 0 seconds to 30 minutes.
- Press **OK** to save changes and return to the auto capture settings display.

12 Press the **i** button.

- The settings confirmation dialog will be displayed.
- The currently selected () **[Capture criteria]** are listed in the top left corner of the dialog.



✓ The Auto Capture Standby Display

- “A- CAP” will be displayed in the control panel.

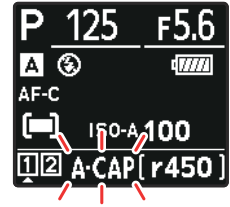

- An **A-CAP** icon will flash in the shooting display.

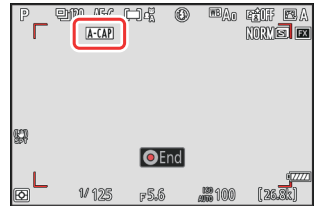

Tip: Pre-Release Capture

The settings selected for Custom Setting d4 [Pre-Release Capture options] apply when [C30] or [C120] is selected for release mode.

Tip: Silent Mode

Silent mode can be enabled by selecting [ON] for [Silent mode] in the setup menu.

“Capture Criteria” > “Motion”

This option is used to choose the direction of motion, size, and speed of subjects that will trigger auto capture.

1 Highlight [Advanced: Motion] in the auto capture settings display and press **OK**.

Motion criteria will be displayed.

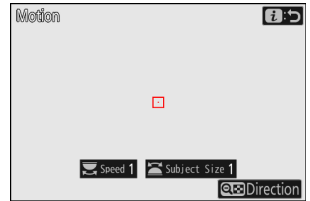

2 Press the **OK (?)** button and select directions.

- Direction criteria will be displayed.
- Highlight directions and press **OK** to select () or deselect ()
- Press **OK** to save changes and return to the motion settings display.

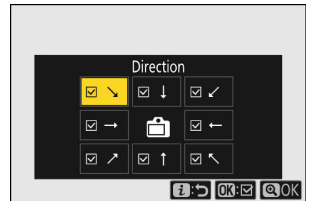

3 Rotate the main command dial to choose the subject speed.

Rotate the main command dial to choose a **[Speed]** of **[1]** to **[5]**. Choose higher values to restrict subject detection to faster-moving subjects, lower values to include subjects moving at slower speeds.

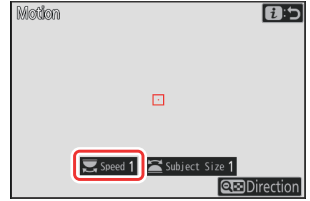

Tip: Size and Speed

- Subjects that meet the criteria for **[Subject Size]** and **[Speed]** are shown by green boxes in the motion settings display.
 - **[Speed]** is measured as the time taken for the subject to cross the frame horizontally. The approximate time for each value is listed below. Subjects that are moving too quickly may not be detected.
 - **[1]**: About 5 s or less
 - **[2]**: About 4 s or less
 - **[3]**: About 3 s or less
 - **[4]**: About 2 s or less
 - **[5]**: About 1 s or less
 - Selecting **[1]** for both **[Subject Size]** and **[Speed]** makes it easier for the camera to detect subjects of a variety of sizes moving at a variety of speeds. We recommend that you begin from low values and then gradually raise them while checking the display of green boxes in the motion settings display or taking test pictures until subject detection functions as desired.
-

4 Rotate the sub-command dial to choose the subject size.

Rotate the sub-command dial to choose a **[Subject Size]** of [1] to [5]. Choose lower values to include smaller subjects, higher values to restrict subject detection to larger subjects.

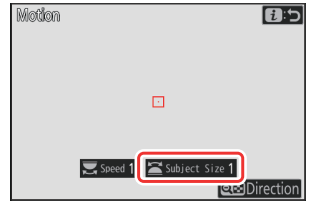

Tip: Size Options

- Subjects that meet the criteria for **[Subject Size]** and **[Speed]** are shown by green boxes in the motion settings display.
- The apparent subject size (measured in focus points) for each **[Subject Size]** option is listed below.
 - [1]: 4 focus points or larger
 - [2]: 8 focus points or larger
 - [3]: 14 focus points or larger
 - [4]: 24 focus points or larger
 - [5]: 34 focus points or larger

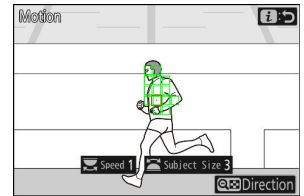

Subject detected in 14 focus points

5 Press the *i* button.

The camera will save the changes and return you to the auto capture settings display.

“Capture Criteria” > “Subject Detection”

This option is used to choose the types and sizes of subject that trigger auto capture.

1 Highlight [Advanced: Subject detection] in the auto capture settings display and press **Ⓜ**.

Subject detection criteria will be displayed.

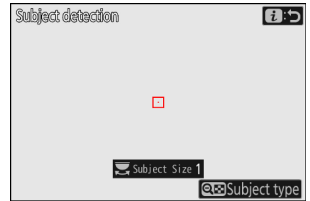

2 Press the **Ⓜ (?)** button and select the desired subject types.

- Your choices are auto, people, animals, and vehicles.
- Press **Ⓜ** to save changes and return to the subject detection display.

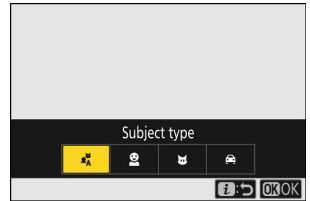

3 Rotate the main command dial to choose the subject size.

Choose a **[Subject Size]** from values [1] through [5]. Choose lower values to include smaller subjects, higher values to restrict subject detection to larger subjects.

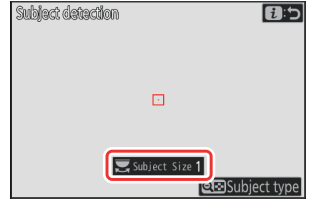

Tip: Size Options

- Subjects that meet the criterion for **[Subject Size]** are shown by green boxes in the subject detection display.
- The apparent subject size (as a percentage of the angle of view) for each setting is listed below.
 - [1]: 2.5% or more
 - [2]: 5% or more
 - [3]: 10% or more
 - [4]: 15% or more
 - [5]: 20% or more

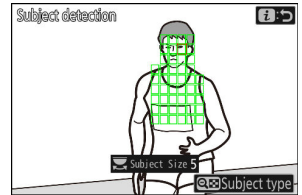

Subject detected at size of
20%

- A **[Subject Size]** of [1] makes it easier for the camera to detect subjects of a variety of sizes. We recommend that you begin from a low value and then gradually raise it while checking the display of green boxes in the subject detection display or taking test pictures until subject detection functions as desired.

4 Press the *i* button.

The camera will save the changes and return you to the auto capture settings display.

✔ Caution: Subject Detection

If "auto" or "people" is selected, auto capture will begin when human portrait subjects are detected, whether or not they are facing the camera.

“Capture Criteria” > “Distance”

Choose the maximum and minimum distances at which the camera will detect subjects for auto capture. Auto capture shooting will continue while the subject is within the specified range of distances.

✓ “Advanced: Distance”

You can use the [Advanced: Distance] feature when a NIKKOR Z lens is attached. It may not function with other lenses.

1 Highlight [Advanced: Distance] in the auto capture settings display and press **OK**.

- Distance criteria will be displayed.
- A focus-point target will appear in the distance criteria display.

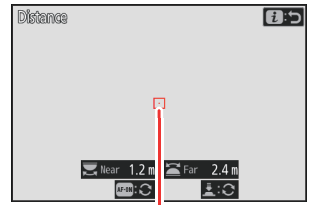

Focus-point target

2 Choose the closest and farthest distances at which the camera will detect subjects for auto capture.

- Place the target over a subject at the closest distance for auto capture subject detection and press the **AF-ON** button to set the minimum distance, which will appear in the display as [Near]. The minimum distance can be fine-tuned by rotating the main command dial.
- Place the target over a subject at the farthest distance for auto capture subject detection and press the shutter-release button halfway to set the maximum distance, which will appear in the display as [Far]. The maximum distance can be fine-tuned by rotating the sub-command dial.

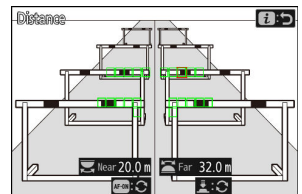
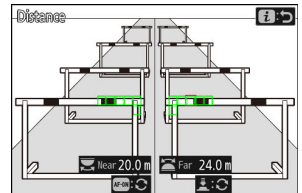

Tip: Fine-Tuning the Distances for “Near” and “Far”

Fine-tuning is available exclusively with Nikon Z mount lenses, but not with the NIKKOR Z 58 mm f/0.95 S Noct.

Tip: The “Near” and “Far” Displays

The distances for [Near] and [Far] are displayed in meters only. They will not be displayed in feet even when [Feet (ft)] is selected for [Distance units] in the setup menu.

3 Press the *i* button.

The camera will save the changes and return you to the auto capture settings display.

Pausing and Ending Auto Capture

- To pause auto capture and return to the settings confirmation dialog, press the video-record button. Auto capture can be resumed by pressing the button again.
- To end auto capture and exit to the shooting display, press the  (⏏) button.

✓ Cautions: Auto Capture

- Image-area selection is fixed at [FX (36×24)]. Auto capture cannot be used when a DX lens is attached.
- During auto-capture standby, the camera focuses as described below.
 - [Capture criteria] > [Distance] enabled (): The camera focuses at the distance in effect when auto capture began.
- The camera may fail to detect subjects in the [Target area] when there are multiple subjects in the frame.
- Falling rain and snow may interfere with subject detection. Auto capture may be triggered by falling snow, heat haze, or other weather phenomena.

✓ During Auto Capture

All controls other than the **DISP**, video-record, and  (⏏) buttons are disabled while auto capture shooting is in progress. End auto capture before attempting to adjust camera settings.

Auto Capture: Restrictions

Auto capture cannot be combined with some camera features, including:

- long time-exposures (“Bulb” or “Time”),
 - the self-timer,
 - bracketing,
 - multiple exposures,
 - HDR overlay,
 - interval-timer photography,
 - time-lapse video recording,
 - focus shift, and
 - electronic vibration reduction.
-

Low ISO Sensitivity Settings for N-Log Video

Low ISO sensitivity options ranging from Lo 0.3 to Lo 2.0 have been added to the choices available for [ISO sensitivity settings] > [ISO sensitivity (mode M)] in the video recording menu when [N-Log] is selected as the video tone mode. Sensitivity can be set to values below ISO 800 by approximately 0.3 to 2.0 EV (equivalent respectively to ISO 640 and 200).

Cautions: Low ISO Sensitivities

The maximum output level for videos recorded at low ISO sensitivities drops due to loss of highlight data. We recommend that you select a low value for Custom Setting g13 [Zebra pattern] > [Highlight threshold] when using the zebra pattern feature. A highlight threshold around [230] is recommended for Lo 0.3 to 1.0 and [200] for Lo 2.0.

New Options for Hi-Res Zoom Speed

Custom Setting g8 [**Hi-Res Zoom speed**] now offers a choice of 11 speeds, from -5 to +5.

- Press ◀ or ▶ to choose the speed.
- The higher the value, the higher the speed; the lower the value, the lower the speed.

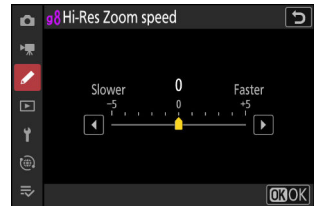

New: Slow-Motion Videos

[1920×1080; 30p ×4 (slow-motion)], [1920×1080; 25p ×4 (slow-motion)], and [1920×1080; 24p ×5 (slow-motion)] have been added to the options available for [Frame size/frame rate] when [H.264 8-bit (MP4)] is selected for [Video file type] in the video recording menu. These options are used to record slow-motion videos.

- Videos shot using [1920×1080; 30p ×4 (slow-motion)], for example, are recorded at a frame rate of 120p and play back at a rate of 30p. It takes around 10 seconds of recording to produce about 40 seconds of footage. Slow-motion videos can be used to view crucial moments in sport and other events of brief duration in slow motion.

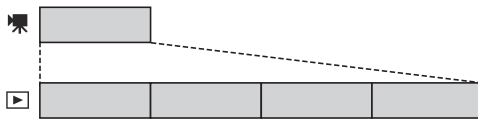

- Sound is not recorded.
- Selecting [DX] for [Choose image area] or mounting a DX lens on the camera increases the apparent focal length by approximately 2.3× when compared to FX format.
- Custom Setting g11 [Extended shutter speeds (mode M)] is disabled.
- Recording and playback speeds are shown below.

Frame size/frame rate	Rate frames are read at *	Rate frames are recorded/play at *
[1920×1080; 30p ×4 (slow-motion)]	120p	30p
[1920×1080; 25p ×4 (slow-motion)]	100p	25p
[1920×1080; 24p ×5 (slow-motion)]	120p	24p

* Actual frame rate is 119.88 fps for values listed as 120p, 29.97 fps for values listed as 30p, and 23.976 fps for values listed as 24p.

- The maximum bit rate is 36 Mbps.
- The maximum recording time is about three minutes.

✓ Cautions: Recording Slow-Motion Videos

- Features that cannot be used during slow-motion video recording include:
 - flicker reduction,
 - electronic vibration reduction, and
 - time code output.
 - Videos recorded at [**1920×1080; 30p ×4 (slow-motion)**], [**1920×1080; 25p ×4 (slow-motion)**], and [**1920×1080; 24p ×5 (slow-motion)**] will not be sent to HDMI devices as slow-motion videos.
-

Changes to *i*-Menu “Select for Upload” Options

Changes have been made to the behavior of the [**Select for upload to computer**] and [**Select for upload (FTP)**] items in the playback *i* menu.

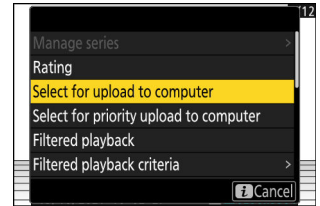

- These options are displayed only if the camera is connected to a computer or FTP server.
- While in earlier versions of the camera firmware, choosing [**Select for upload to computer**] or [**Select for upload (FTP)**] would mark the current picture for priority upload (📁) and begin upload immediately, from “C” version firmware 4.00 these options simply mark the picture for upload (📁). Pictures with this marking will be added to the end of the upload queue and not begin uploading until upload of any pictures ahead of them in the queue is complete.

"Priority Upload" Options Added to **i** Menu

[**Select for priority upload to computer**] and [**Select for priority upload (FTP)**] items have been added to the playback **i** menu.

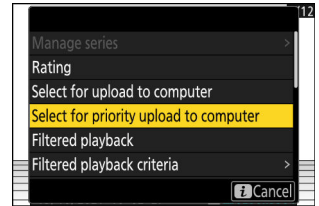







- These options are displayed only if the camera is connected to a computer or FTP server.
- To mark the current picture for priority upload (📧) and begin upload immediately, press the **i** button, highlight [**Select for priority upload to computer**] or [**Select for priority upload (FTP)**], and press ⓧ. Pictures marked for priority upload will be uploaded before pictures marked for upload using other means.

Support for Power Zoom



The camera now supports power zoom for use with power zoom (PZ) lenses. In addition to using the lens zoom ring, you now have the option of zooming power zoom lenses attached to the camera in and out using camera controls (“power zoom”).





New Custom Setting: f12 “Assign Power Zoom Buttons”

Choose whether the  and  buttons can be used for power zoom during still photography when a power zoom lens is attached.

Option	Description
[Use  /  buttons]	Selecting [ON] allows the  and  buttons to be used for power zoom.
[Power zoom speed]	Choose the speed at which power zoom lenses can be zoomed in and out using the buttons.

New Custom Setting: g9 “Assign Power Zoom Buttons”

Choose whether the  and  buttons can be used for power zoom during video recording when a power zoom lens is attached.

Option	Description
[Use  /  buttons]	Selecting [ON] allows the  and  buttons to be used for power zoom.
[Power zoom speed]	Choose the speed at which power zoom lenses can be zoomed in and out using the buttons; if desired, you can choose one speed for use during recording and another for pre- and post-recording. <ul style="list-style-type: none">Note that the sounds produced by the lens may be audible in footage recorded during zoom. The effect can be mitigated by selecting a slower zoom speed.

Tip: Assigning Power Zoom to Camera Controls

The power zoom role can be assigned to camera controls using options newly added to Custom Settings f2 [**Custom controls (shooting)**] and g2 [**Custom controls**]. This role can be assigned to the Fn1 and Fn2 buttons ([📖 970](#)).

New Setup Menu Item: “Save Zoom Position (PZ Lenses)”

If **[ON]** is selected when a power zoom (PZ) lens is attached, the camera will save the current zoom position when turned off and restore it when next turned on. Note that this increases camera startup times.

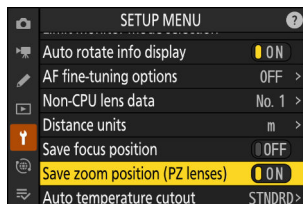

The Focal Length Display

The lens focal length is shown in the shooting display when a power zoom lens is attached.

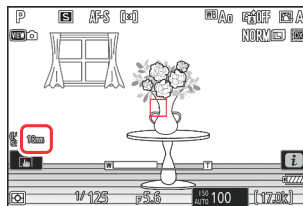

New Custom Setting: d6 “Exposure Delay Mode”





An [**Exposure delay mode**] item has been added to the Custom Settings menu at position d6. It can be used to delay the release of the shutter until about 0.2 to 3 seconds after the shutter-release button has been pressed, helping to reduce blur caused by camera shake.

New Options for Custom Settings f2 “Custom Controls (Shooting)” and g2 “Custom Controls”

Additions have been made to the roles available for Custom Setting f2 [**Custom controls (shooting)**] or g2 [**Custom controls**] and the controls to which they can be assigned. In addition, custom controls can now be reset.

New Reset Option



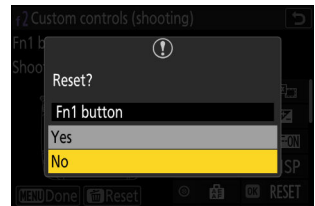

You can now reset selected controls to their default roles in the control-selection displays for Custom Settings f2 [**Custom controls (shooting)**] and g2 [**Custom controls**].

- Highlight the desired control and press  to display a confirmation dialog where you can reset the control to its default role by highlighting [**Yes**] and pressing .
- Pressing and holding the  button for about three seconds when a control is highlighted displays a confirmation dialog where you can reset all controls to their default roles by highlighting [**Yes**] and pressing .



Newly Customizable Controls

The following controls can now be customized:

-  [**WB button**]
-  [**Playback button**]
-  [**Flash mode button**]
-  [**BKT button**]

New Roles Available via Custom Setting f2 “Custom Controls (Shooting)”

Option		Description
	[Switch eyes]	Press the control to choose the eye used for focus when the camera detects the eyes of a human or animal portrait subject.
PZ[T]	[Power zoom +]	Press the control to zoom in using power zoom when a power zoom lens is attached. This option is enabled automatically when [Power zoom –] is selected for [Fn2 button].
PZ[W]	[Power zoom –]	Press the control to zoom out using power zoom when a power zoom lens is attached. This option is enabled automatically when [Power zoom +] is selected for [Fn1 button].
DL	[Exposure delay mode]	Hold the control and rotate a command dial to choose the exposure delay.

New Roles Available via Custom Setting g2 “Custom Controls”





Option		Description
	[Switch eyes]	Press the control to choose the eye used for focus when the camera detects the eyes of a human or animal portrait subject.
PZ[T]	[Power zoom +]	Press the control to zoom in using power zoom when a power zoom lens is attached. This option is enabled automatically when [Power zoom –] is selected for [Fn2 button].
PZ[W]	[Power zoom –]	Press the control to zoom out using power zoom when a power zoom lens is attached. This option is enabled automatically when [Power zoom +] is selected for [Fn1 button].

New Options for Custom Setting f3: “Custom Controls (Playback)”

Additions have been made to the roles available for Custom Setting f3 [**Custom controls (playback)**]. An option has also been added to control the behavior of frame advance during playback zoom. In addition, custom controls can now be reset.

New Reset Option



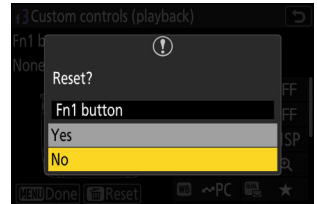

You can now reset selected controls to their default roles in the Custom Setting f3 [**Custom controls (playback)**] control-selection display.

- Highlight the desired control and press  (Reset) to display a confirmation dialog where you can reset the control to its default role by highlighting [Yes] and pressing .
- Pressing and holding the  (Reset) button for about three seconds when a control is highlighted displays a confirmation dialog where you can reset all controls to their default roles by highlighting [Yes] and pressing .



Newly Customizable Controls

The following controls can now be customized:

-  [Playback button]
-  [BKT button]
-  [Flash mode button]
-  [Lens Fn2 button]
-  [Lens Fn button]

New Roles

Option		Description
	[Delete]	Press the control once to display a confirmation dialog. Press the control again to delete the current picture and return to playback.
[Frame advance zoom position]		Choose how the camera centers the display when either the main or sub-command dial is rotated to scroll through pictures during playback zoom. <ul style="list-style-type: none">• [Keep current zoom position]: Center the display on the current zoom location.• [Prefer focus point]: Center the display on the focus point active when the photograph was taken.

Updates to “Non-CPU Lens Data”

- The [Focal length (mm)] and [Maximum aperture] options for [Non-CPU lens data] in the setup menu can now be used to enter a value of your choice.

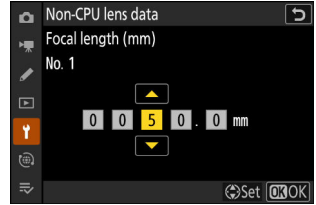

- Names can be assigned to lenses with a [Lens number] of from [1] to [20]. To enter a name of up to 36 characters, highlight [Lens name] and press .
 - The lens names assigned above are recorded in the Exif data stored in pictures.



Increased Character Limit for IPTC “Category” Entries

The character limit for “Category” entries in IPTC presets created or edited using the camera has been increased from 3 to 256.

New Shutter Sound and Volume Options

New options have been added to the **[Camera sounds]** item in the setup menu. Shutter sound volume can now be set separately from other electronic sounds. You can also choose the types of the shutter sound.

Option	Description
[Shutter sound]	If [ON] is selected, the camera will make a sound when the shutter is released.
[Volume]	Choose the volume of the electronic shutter sound from a total of five options.
[Type]	Choose from 5 types of shutter sound.
[Beep]	<ul style="list-style-type: none">• Same as the [Beep on/off] function with camera "C" firmware version 3.xx or earlier. If you select [On] or [Off (touch controls only)], beeps will sound when:<ul style="list-style-type: none">- the self-timer counts down,- interval-timer photography, time-lapse video recording, or focus shift ends,- the camera focuses in photo mode (note that this does not apply if AF-C is selected for focus mode or if [Release] is selected for Custom Setting a2 [AF-S priority selection]), or- touch controls are used (but note that beeps will not sound for touch controls if [Off (touch controls only)] is selected).• Select [Off] to mute the beep speaker.
[Volume]	Choose from three options for beep volume.
[Pitch]	Choose the pitch of the beep from [High] and [Low] .

Support for “Viewfinder Display Size” Selection in Video Mode

The selected option in [**Finder display size (photo Lv)**] in the setup menu now applies to both photo and video modes. This item has consequently been renamed [**Viewfinder display size**]. Select the viewfinder display magnification during shooting and playback from [**Standard**] and [**Small**].

Updated Distance Display for Manual Focus

The focus distance indicator for manual focus now shows the distance between the camera and the focus position in units of your choosing.

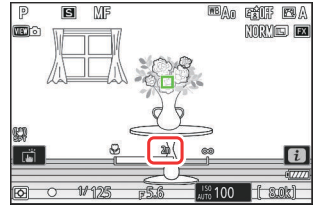

- The choice is made using a **[Distance units]** item newly added to the setup menu, which has options for **[Meters (m)]** and **[Feet (ft)]**.

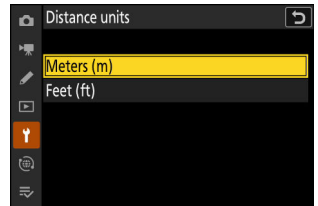



- The distance shown is intended as a guide only. It may vary from the actual distance, depending on the lens used.

Changes and Additions to “Connect to FTP Server”

Changes and additions have been made to the [Connect to FTP server] item in the network menu.

Increased Profile Storage

The number of network profiles that can be saved using [Connect to FTP server] > [Network settings] > [Copy to/from card] > [Copy profile to card] has been increased from 1 to 99.

- Highlight [Copy profile to card] and press , and then highlight a profile you wish to save and press  again. Select the destination (1–99) and press  to copy the profile to the card.

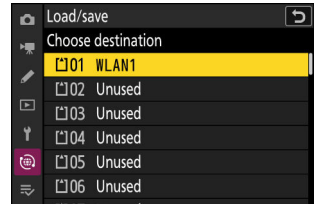
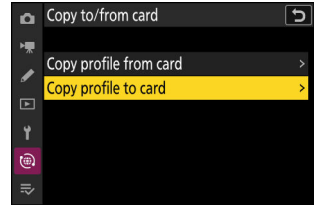

Auto Reconnect on Error

[Keep connection] has been added to the options available for [Connect to FTP server] > [Options] in the network menu. If the connection is lost due to a wireless, TCP/IP, or FTP error when [ON] is selected, the camera will automatically attempt to reconnect after about 15 seconds. The camera will attempt to reconnect repeatedly until the connection is re-established.

- The standby timer will not expire when [ON] is selected, regardless of the option selected for Custom Setting c3 [Power off delay] > [Standby timer]. Note that this increases the drain on the battery.

Changes to Synchronized Release

A **[Group settings]** item has been added under **[Connect to other cameras]** in the network menu. Cameras can be grouped for synchronized release and remote camera settings adjusted separately for each group. Switching groups switches the remote cameras the master camera controls.

- The addition of **[Group settings]** changes how cameras are configured for synchronized release. The procedure described below replaces that described under “Synchronized Release” in the “Connecting to Other Cameras” chapter of the *Reference Guide*.
- Remote cameras can now be grouped. **[Remote camera list]** has consequently been moved from its former location directly under **[Connect to other cameras]** in earlier firmware versions and placed in **[Connect to other cameras] > [Group settings] > (group name) > [Remote camera list]**.

Configuring and Using Synchronized Release

Follow the steps below to create host profiles for synchronized release. Each camera saves the pictures it takes to its own memory card. Repeat the process to create identical profiles for each camera.

Wireless LAN

To create host profiles when connecting via wireless LAN:

- 1 Select **[Connect to other cameras]** in the network menu, then highlight **[Network settings]** and press **↩**.

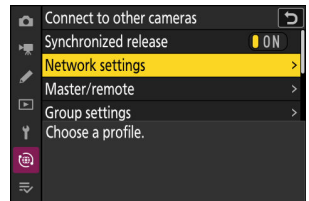

- 2 Highlight **[Create profile]** and press **⊗**.

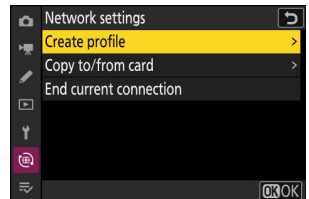

3 Name the new profile.

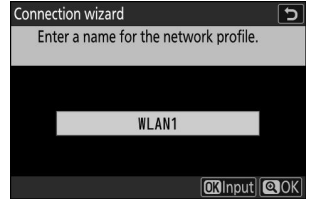

- To proceed to the next step without changing the default name, press **↩**.
- Whatever name you choose will appear in the network menu [**Connect to other cameras**] > [**Network settings**] list.
- To rename the profile, press **⊗**. Press **↩** to proceed after entering a name.

4 Highlight [Search for Wi-Fi network] and press **⊗**.

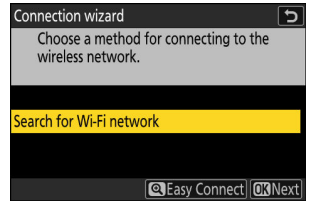

The camera will search for networks currently active in the vicinity and list them by name (SSID).

✓ "Easy Connect"

- To connect without entering an SSID or encryption key, press **↩** in Step 4. Next, press **⊗** and choose from the options below.

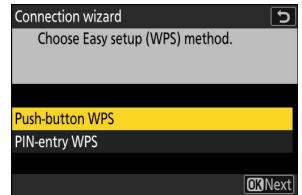

Option	Description
[Push-button WPS]	For routers that support push-button WPS. Press the WPS button on the router and then press the camera ⊗ button to connect.
[PIN-entry WPS]	The camera will display a PIN. Using a computer, enter the PIN on the router. For more information, see the documentation provided with the router.

- After connecting, proceed to Step 7.

5 Choose a network.

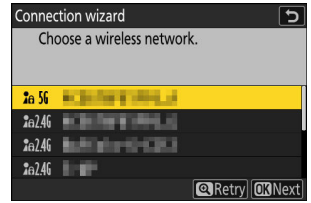

- Highlight a network SSID and press **Ⓢ**.
- The band on which each SSID operates is indicated by an icon.
- Encrypted networks are indicated by a **🔒** icon. If the selected network is encrypted (**🔒**), you will be prompted to enter the encryption key. If the network is not encrypted, proceed to Step 7.
- If the desired network is not displayed, press **🔍** to search again.

✔ Hidden SSIDs

Networks with hidden SSIDs are indicated by blank entries in the network list.

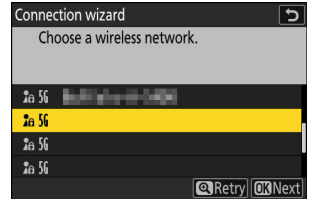

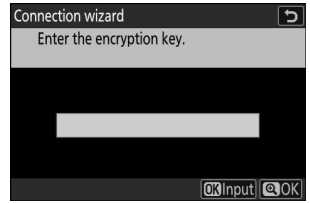

- To connect to a network with a hidden SSID, highlight a blank entry and press **Ⓢ**. Next, press **Ⓢ**; the camera will prompt you to provide an SSID.
 - Enter the network name and press **🔍**. Press **🔍** again; the camera will now prompt you to enter the encryption key.
-

6 Enter the encryption key.

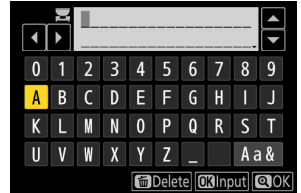

- Press  and enter the encryption key for the wireless router.
- For more information on the wireless router encryption key, see the documentation for the wireless router.



- Press  when entry is complete.
- Press  again to initiate the connection. A message will be displayed for a few seconds when the connection is established.

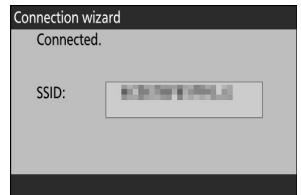

7 Obtain or select an IP address.

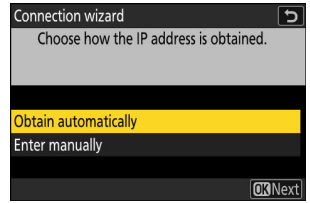

- Highlight one of the following options and press **⏎**.

Option	Description
[Obtain automatically]	Select this option if the network is configured to supply the IP address automatically. A "configuration complete" message will be displayed once an IP address has been assigned. <ul style="list-style-type: none">- It is recommended that you note the remote camera IP address, as you will need it in subsequent steps.
[Enter manually]	Enter the IP address and sub-net mask manually. <ul style="list-style-type: none">- Press ⏎; you will be prompted to enter the IP address.- Rotate the main command dial to highlight segments.- Press ⬅ or ➡ to change the highlighted segment and press ⏎ to proceed.- Next, press Ⓜ; a "configuration complete" message will be displayed. Press Ⓜ again to display the sub-net mask.- Press ⬅ or ➡ to edit the sub-net mask and press ⏎; a "configuration complete" message will be displayed.

- Press **⏎** to proceed when the "configuration complete" message is displayed.
- The profile name is displayed when a connection is established.

8 Highlight [Master/remote] and press .

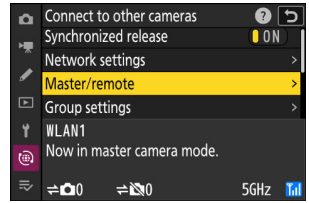

Choose a role for each camera from “master” and “remote”.

- **[Master camera]:** Pressing the shutter-release button on the master camera releases the shutters on the remote cameras. Each group can have only one master. If the group has multiple master cameras, only the first to connect to the network will actually serve in that capacity.
- **[Remote camera]:** The shutters on the remote cameras are synchronized with the shutter on the master camera.

9 Repeat Steps 1 through 8 for the remaining cameras.

When configuring remote cameras, be sure to select **[Remote camera]** in Step 8.

10 On the master camera, highlight [Group settings] and press .

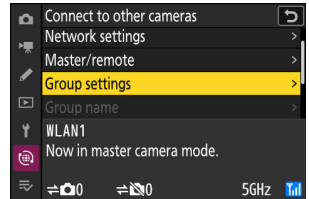

11 Highlight [New] and press .

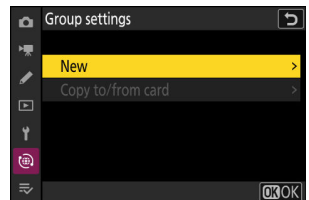

12 Enter the group display name.

- Choose the display name for the remote camera group.
Display names can be up to 32 characters long.
- Press **OK** to proceed once entry is complete.



13 Highlight [Group name], press **OK**, and enter a group name.

Enter a group name for the synchronized cameras. Group names can be up to eight characters long.



✓ Assigning Remote Cameras a “Group Name”

The group name selected on the remote cameras must match that chosen for the master camera. Choose the name using **[Connect to other cameras] > [Group name]** in the network menu.

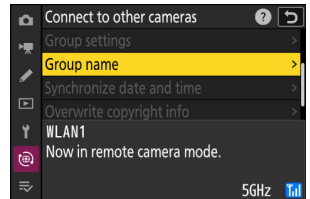

14 Highlight [Remote camera list] and press **OK**.

Add remote cameras to the group. The master camera can store information for up to 16 remote cameras in slots **[01]** through **[16]**.

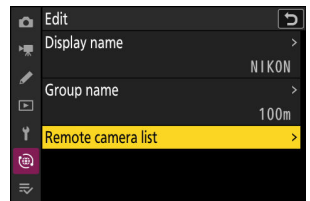

15 Highlight the desired slot and press .

Remote camera options will be displayed.

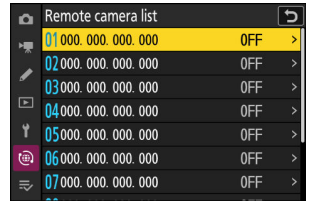

16 Highlight [Address] and press .



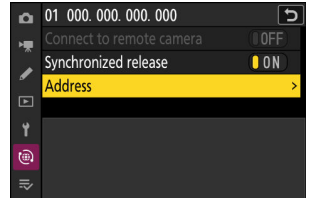

You will be prompted to enter an IP address.

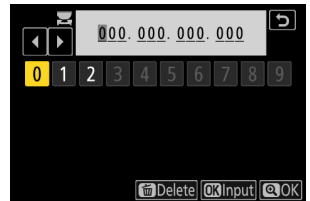

17 Enter the remote camera IP address.



Enter the remote camera IP address you noted in Step 7.

- Rotate the main command dial to highlight segments.
- Press  or  to change the highlighted segment and press  to proceed.
- Press  to add the remote camera to the master camera remote camera list and establish a connection.

Tip: Viewing Remote Camera IP Addresses

To view a remote camera's IP address, select **[Connect to other cameras]** > **[Network settings]** in the camera's network menu, highlight a synchronized release host profile, press , and select **[TCP/IP]**.

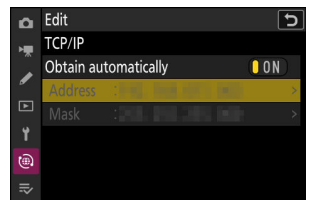

18 Add the remaining remote cameras.

- When connecting to wireless networks, the cameras will display the band used by the selected SSID.
- The master camera shows the number of cameras in the group currently connected or not connected.

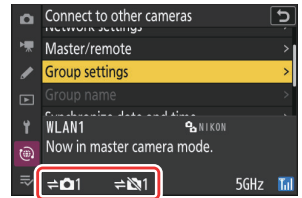

- The shooting display for the master camera shows a  icon together with the number of remote cameras connected.

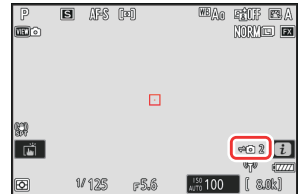

Connection Errors

In the event of remote camera connection errors, the remote camera count in the master camera shooting display will turn red and instead show the number of remote cameras that failed to connect.

19 Take pictures.

Pressing the shutter-release button on the master camera releases the shutters on the remote cameras.

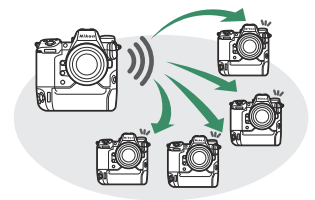

Ethernet

Follow the steps below to create host profiles for Ethernet connections. Before proceeding, connect an Ethernet cable to the camera's Ethernet connector. Do not use force or attempt to insert the connectors at an angle. Connect the other end of the cable to a router.

1 Select **[ON]** for **[Wired LAN]** in the network menu.

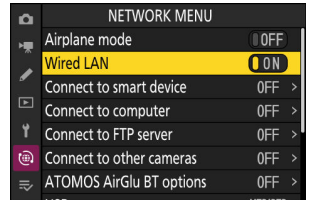

2 Select **[Connect to other cameras]** in the network menu, then highlight **[Network settings]** and press **↩**.

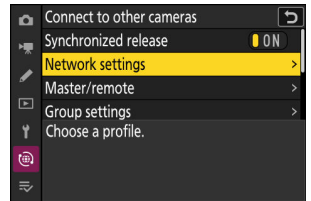

3 Highlight **[Create profile]** and press **↩**.

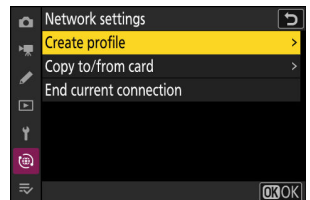

4 Name the new profile.

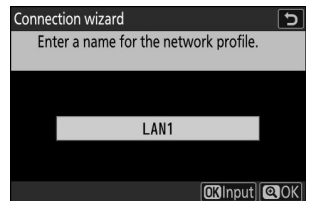

- To display IP address options without changing the default name, press **↩**.
- Whatever name you choose will appear in the network menu **[Connect to other cameras]** > **[Network settings]** list.
- To rename the profile, press **↩**. Press **↩** to proceed after entering a name.

5 Obtain or select an IP address.

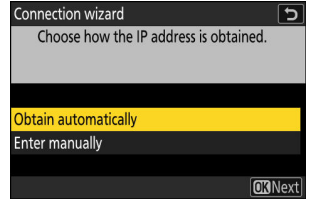

- Highlight one of the following options and press **⏎**.

Option	Description
[Obtain automatically]	Select this option if the network is configured to supply the IP address automatically. A “configuration complete” message will be displayed once an IP address has been assigned. <ul style="list-style-type: none"> - It is recommended that you note the remote camera IP address, as you will need it in subsequent steps.
[Enter manually]	Enter the IP address and sub-net mask manually. <ul style="list-style-type: none"> - Press ⏎; you will be prompted to enter the IP address. - Rotate the main command dial to highlight segments. - Press ⬅ or ➡ to change the highlighted segment and press ⏎ to proceed. - Next, press Ⓚ; a “configuration complete” message will be displayed. Press Ⓚ again to display the sub-net mask. - Press ⬅ or ➡ to edit the sub-net mask and press ⏎; a “configuration complete” message will be displayed.

- Press **⏎** to proceed when the “configuration complete” message is displayed.
- The camera will initiate the connection. The profile name is displayed when a connection is established.

6 Highlight [Master/remote] and press .

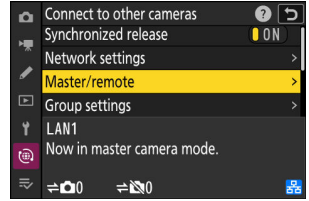

Choose a role for each camera from “master” and “remote”.

- **[Master camera]:** Pressing the shutter-release button on the master camera releases the shutters on the remote cameras. Each group can have only one master. If the group has multiple master cameras, only the first to connect to the network will actually serve in that capacity.
- **[Remote camera]:** The shutters on the remote cameras are synchronized with the shutter on the master camera.

7 Repeat Steps 1 through 6 for the remaining cameras.

When configuring remote cameras, be sure to select **[Remote camera]** in Step 6.

8 On the master camera, highlight [Group settings] and press .

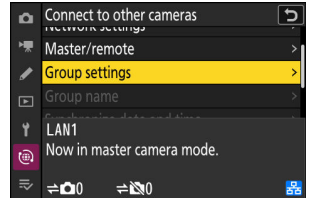

9 Highlight [New] and press .

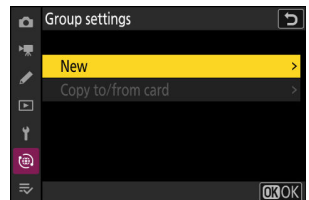

10 Enter the group display name.

- Choose the display name for the remote camera group.
Display names can be up to 32 characters long.
- Press **OK** to proceed once entry is complete.



11 Highlight [Group name], press **OK**, and enter a group name.

Enter a group name for the synchronized cameras. Group names can be up to eight characters long.



✓ Assigning Remote Cameras a “Group Name”

The group name selected on the remote cameras must match that chosen for the master camera. Choose the name using **[Connect to other cameras] > [Group name]** in the network menu.

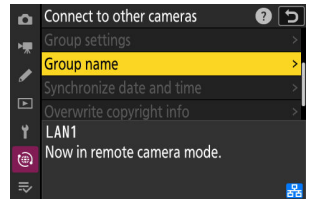

12 Highlight [Remote camera list] and press **OK**.

Add remote cameras to the group. The master camera can store information for up to 16 remote cameras in slots **[01]** through **[16]**.

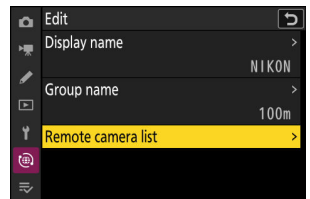

13 Highlight the desired slot and press .

Remote camera options will be displayed.

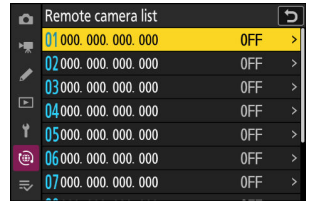

14 Highlight [Address] and press .



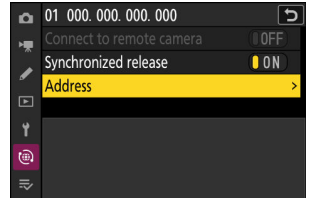

You will be prompted to enter an IP address.

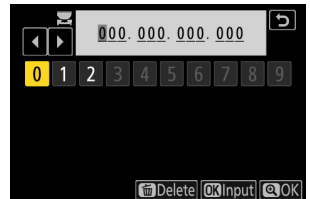

15 Enter the remote camera IP address.



Enter the remote camera IP address you noted in Step 5.

- Rotate the main command dial to highlight segments.
- Press  or  to change the highlighted segment and press  to proceed.
- Press  to add the remote camera to the master camera remote camera list and establish a connection.

Tip: Viewing Remote Camera IP Addresses

To view a remote camera's IP address, select **[Connect to other cameras] > [Network settings]** in the camera's network menu, highlight a synchronized release host profile, press , and select **[TCP/IP]**.

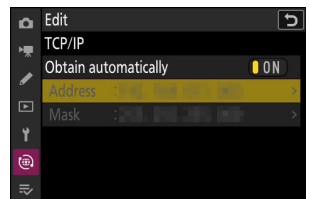

16 Add the remaining remote cameras.

- The master camera shows the number of cameras in the group currently connected or not connected.

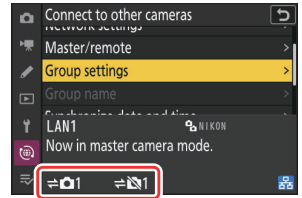

- The shooting display for the master camera shows a camera icon together with the number of remote cameras connected.

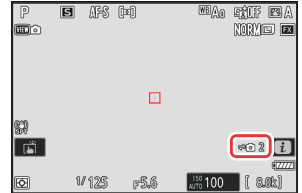

✓ Connection Errors

In the event of remote camera connection errors, the remote camera count in the master camera shooting display will turn red and instead show the number of remote cameras that failed to connect.

17 Take pictures.

Pressing the shutter-release button on the master camera releases the shutters on the remote cameras.

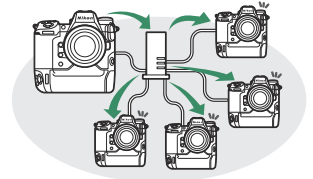

Tip: Suspending Synchronized Release

To temporarily disable synchronized release without ending the camera's connection to the network, select **[OFF]** for **[Connect to other cameras]** > **[Synchronized release]** in the network menu.

Tip: Viewing Remote Camera Status

To view remote camera status, go to **[Connect to other cameras]** > **[Group settings]** > (group name) in the master camera network menu, highlight **[Remote camera list]**, and press \odot .

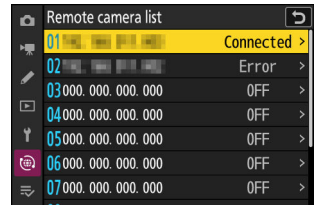

- Remote cameras are identified by IP address.
- Remote camera status is displayed as follows:
 - **[Connected]**: Normal connection.
 - **[Busy]**: The camera is being controlled from another master camera.
 - **[Error]**: One of the following errors has been detected:
 - The remote camera standby timer has expired.
 - The remote camera is off.
 - The remote camera is not in the same group as the master camera.
 - The IP address is incorrect.
 - **[OFF]**: Either
 - no remote camera has been assigned to the slot, or
 - **[OFF]** is selected for **[Connect to remote camera]** for the camera in question.
- Highlighting a remote camera with the **[Connected]** label and pressing \odot displays the number of pictures awaiting upload from the camera via FTP, FTP connection status, the battery level, and the number of exposures remaining.
- The entries for the remote cameras previously used for synchronized release will show the time of the most recent shot.
- To edit remote camera settings from the master camera, highlight the camera in the remote camera list and press \odot .

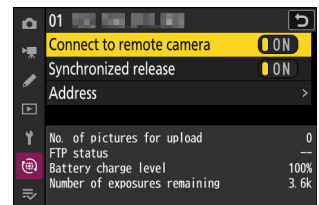

- To temporarily suspend the connection to the selected camera, select **[OFF]** for **[Connect to remote camera]**.
- To temporarily suspend synchronized release on the selected camera, select **[OFF]** for **[Synchronized release]**.

- If desired, you can then edit the camera's IP address by highlighting **[Address]** and pressing **Ⓢ**. To reconnect, select **[ON]** for **[Connect to remote camera]**. No connection will be established if no remote camera exists at the specified address.

Tip: Saving Group Settings to a Memory Card.

Navigate to **[Connect to other cameras]** > **[Group settings]** > **[Copy to/from card]** in the network menu, highlight **[Copy to card]**, press **Ⓢ**, and then highlight group settings you wish to save and press **Ⓢ** again. Select the destination (1–99) and press **Ⓢ** to copy the group settings to the card. Saved group settings can be loaded using **[Copy from card]**.

New “Overwrite Copyright Info” Option for Master Cameras

[**Overwrite copyright info**] has been added to the options available for [**Connect to other cameras**] in the network menu. Selecting this option overwrites the copyright information on any remote cameras currently connected with the copyright information stored on the master camera.

Menu Items and Defaults for “C” Firmware Version 4.00

The menu items and defaults after the firmware has been upgraded to “C” firmware version 4.00 are listed below.

Photo Shooting Menu

- [Shooting menu bank]: A
- [Extended menu banks]: OFF
- [Storage folder]
 - [Rename]: NCZ_9
 - [Select folder by number]: 100
 - [Select folder from list]: —
- [File naming]: DSC
- [Role played by card in Slot 2]: Overflow
- [Image area]
 - [Choose image area]: FX (36×24)
 - [DX crop alert]: OFF
- [Image quality]: JPEG normal
- [Image size settings]
 - [Image size]: Large
 - [Enable DX image sizes]: OFF
 - [Image size (DX)]: Large
- [RAW recording]: High efficiency★
- [ISO sensitivity settings]
 - [ISO sensitivity]: 100
 - [Auto ISO sensitivity control]: ON
 - [Maximum sensitivity]: 25600
 - [Maximum sensitivity with $\frac{1}{2}$]: Same as without flash
 - [Minimum shutter speed]: Auto
- [White balance]: Auto—Keep white (reduce warm colors)
- [Set Picture Control]: Auto
- [Manage Picture Control]: —
- [Color space]: sRGB
- [Active D-Lighting]: Off
- [Long exposure NR]: OFF
- [High ISO NR]: Normal
- [Vignette control]: Normal

- **[Diffraction compensation]**: ON
- **[Auto distortion control]**: ON
- **[Photo flicker reduction]**: OFF
- **[High-frequency flicker reduction]**: Off
- **[Metering]**: Matrix metering
- **[Flash control]**
 - **[Flash control mode]**: TTL
 - **[Wireless flash options]**: Off
 - **[Remote flash control]**: Group flash
- **[Focus mode]**: Single AF
- **[AF-area mode]**: Single-point AF
- **[AF subject detection options]**: Auto
- **[Vibration reduction]**: Sport
- **[Auto bracketing]**
 - **[Auto bracketing set]**: AE & flash bracketing
 - **[Number of shots]**: 0
 - **[Increment]**: 1.0
- **[Multiple exposure]**
 - **[Multiple exposure mode]**: Off
 - **[Number of shots]**: 2
 - **[Overlay mode]**: Average
 - **[Save individual pictures (RAW)]**: ON
 - **[Overlay shooting]**: ON
 - **[Select first exposure (RAW)]**: —
- **[HDR overlay]**
 - **[HDR mode]**: Off
 - **[HDR strength]**: Auto
 - **[Save individual pictures (RAW)]**: OFF
- **[Interval timer shooting]**
 - **[Choose start day/time]**: Now
 - **[Interval]**: 1 min.
 - **[Intervals×shots/interval]**: 0001×1
 - **[Exposure smoothing]**: ON
 - **[Interval priority]**: OFF
 - **[Focus before each shot]**: OFF
 - **[Options]**: Off
 - **[Starting storage folder]**
 - **[New folder]**:
 - **[Reset file numbering]**:
- **[Time-lapse video]**
 - **[Interval]**: 5 s
 - **[Shooting time]**: 25 min.
 - **[Exposure smoothing]**: ON

- [Choose image area]: FX
- [Video file type]: H.265 8-bit (MOV)
- [Frame size/frame rate]: 3840×2160; 30p
- [Interval priority]: OFF
- [Focus before each shot]: OFF
- [Destination]: Slot 1
- [Focus shift shooting]
 - [No. of shots]: 100
 - [Focus step width]: 5
 - [Interval until next shot]: 0
 - [First-frame exposure lock]: ON
 - [Focus position auto reset]: OFF
 - [Starting storage folder]
 - [New folder]:
 - [Reset file numbering]:
- [Auto capture]
 - [Select user preset]: P-1

Video Recording Menu

- [Shooting menu bank]: A
- [Extended menu banks]: OFF
- [Storage folder]
 - [Rename]: NCZ_9
 - [Select folder by number]: 100
 - [Select folder from list]: —
- [File naming]: DSC
- [Destination]: Slot 1
- [Video file type]: H.265 8-bit (MOV)
- [Frame size/frame rate]: 3840×2160; 30p
- [Video quality (N-RAW)]: High quality
- [Image area]
 - [Choose image area]: FX
 - [DX crop alert]: OFF
- [Extended oversampling]: OFF
- [ISO sensitivity settings]
 - [Maximum sensitivity]: 25600
 - [Auto ISO control (mode M)]: ON
 - [ISO sensitivity (mode M)]: 100
- [White balance]: Same as photo settings
- [Set Picture Control]: Same as photo settings
- [Manage Picture Control]: —
- [HLG quality]
 - [Quick sharp]: 0
 - [Contrast]: 0
 - [Saturation]: 0
 - [Hue]: 0
- [Active D-Lighting]: Off
- [High ISO NR]: Normal
- [Vignette control]: Normal
- [Diffraction compensation]: ON
- [Auto distortion control]: ON
- [Video flicker reduction]: Auto
- [High-frequency flicker reduction]: Off
- [Metering]: Matrix metering
- [Focus mode]: Full-time AF
- [AF-area mode]: Single-point AF
- [AF subject detection options]
 - [Subject detection]: Auto
 - [AF when subject not detected]: ON

- **[Vibration reduction]**: Same as photo settings
- **[Electronic VR]**: OFF
- **[Microphone sensitivity]**: Auto
- **[Attenuator]**: OFF
- **[Frequency response]**: Wide range
- **[Wind noise reduction]**: OFF
- **[Mic jack plug-in power]**: ON
- **[Headphone volume]**: 15
- **[Timecode]**
 - **[Record timecodes]**: Off
 - **[Count-up method]**: Record run
 - **[Timecode origin]**: —
 - **[Drop frame]**: ON
- **[External rec. cntrl (HDMI)]**: OFF
- **[Hi-Res Zoom]**: OFF
- **[Auto capture]**
 - **[Select user preset]**: P-1



Custom Settings Menu





- [Custom Settings bank]: A
- a [Focus]
 - a1: [AF-C priority selection]: Release
 - a2: [AF-S priority selection]: Focus
 - a3: [Focus tracking with lock-on]
 - [Blocked shot AF response]: 3
 - [Subject motion]: Steady
 - a4: [Focus points used]: All points
 - a5: [Store points by orientation]: Off
 - a6: [AF activation]: Shutter/AF-ON
 - a7: [Focus point persistence]: Auto
 - a8: [Limit AF-area mode selection]
 - [Pinpoint AF]:
 - [Single-point AF]: (cannot be deselected)
 - [Dynamic-area AF (S)]:
 - [Dynamic-area AF (M)]:
 - [Dynamic-area AF (L)]:
 - [Wide-area AF (S)]:
 - [Wide-area AF (L)]:
 - [Wide-area AF (C1)]:
 - [Wide-area AF (C2)]:
 - [3D-tracking]:
 - [Auto-area AF]:
 - a9: [Focus mode restrictions]: No restrictions
 - a10: [Focus point wrap-around]: OFF
 - a11: [Focus point display]
 - [Manual focus mode]: ON
 - [Dynamic-area AF assist]: ON
 - [AF-C in-focus display]: OFF
 - [3D-tracking focus point color]: White
 - a12: [Built-in AF-assist illuminator]: ON
 - a13: [Focus peaking]
 - [Focus peaking display]: OFF
 - [Focus peaking sensitivity]: 2 (standard)
 - [Focus peaking highlight color]: Red
 - a14: [Focus point selection speed]: Normal
 - a15: [Manual focus ring in AF mode]: ON
- b [Metering/exposure]
 - b1: [ISO sensitivity step value]: 1/3 step
 - b2: [EV steps for exposure cntrl]: 1/3 EV steps (comp. 1/3 EV)



- b3: **[Easy exposure compensation]**: Off
- b4: **[Matrix metering face detection]**: ON
- b5: **[Center-weighted area]**: Standard
- b6: **[Fine-tune optimal exposure]**
 - **[Matrix metering]**: 0
 - **[Center-weighted metering]**: 0
 - **[Spot metering]**: 0
 - **[Highlight-weighted metering]**: 0
- b7: **[Keep exp. when f/ changes]**: Exposure maintenance off
- **c [Timers/AE lock]**
 - c1: **[Shutter-release button AE-L]**: Off
 - c2: **[Self-timer]**
 - **[Self-timer delay]**: 10 s
 - **[Number of shots]**: 1
 - **[Interval between shots]**: 0.5 s
 - c3: **[Power off delay]**
 - **[Playback]**: 10 s
 - **[Menus]**: 1 min
 - **[Picture review]**: 4 s
 - **[Standby timer]**: 30 s
- **d [Shooting/display]**
 - d1: **[Continuous shooting speed]**
 - **[Continuous high-speed]**: 20 fps
 - **[Continuous low-speed]**: 5 fps
 - d2: **[Maximum shots per burst]**: ∞
 - d3: **[Limit release mode selection]**
 - **[Single frame]**: ✓ (cannot be deselected)
 - **[Continuous L]**: ☑
 - **[Continuous H]**: ☑
 - **[C30]**: ☑
 - **[C60]**: ☑
 - **[C120]**: ☑
 - **[Self-timer]**: ☑
 - d4: **[Pre-Release Capture options]**
 - **[Pre-release burst]**: None
 - **[Post-release burst]**: Max.
 - d5: **[Sync. release mode options]**: Sync
 - d6: **[Exposure delay mode]**: Off
 - d7: **[Extended shutter speeds (M)]**: OFF
 - d8: **[Limit selectable image area]**
 - **[FX (36×24)]**: ✓ (cannot be deselected)
 - **[DX (24×16)]**: ☑
 - **[1:1 (24×24)]**: ☑

- [16:9 (36×20)]:
- d9: [File number sequence]: On
- d10: [View mode (photo Lv)]: Show effects of settings
 - [Show effects of settings]: Only when flash is not used
 - [Adjust for ease of viewing]: Auto
- d11: [Starlight view (photo Lv)]: OFF
- d12: [Warm display colors]
 - [Warm display color options]: Off
 - [Warm color display brightness]: 0
- d13: [LCD illumination]: OFF
- d14: [View all in continuous mode]: ON
- d15: [Release timing indicator]
 - [Indicator type]: Type B
 - [Type A auto restore delay]: 1/6 s
- d16: [Image frame]: ON
- d17: [Grid type]: 3×3
- d18: [Virtual horizon type]: Type A
- d19: [Custom monitor shooting display]
 - [Display 1]: ✓ (cannot be deselected)
 - [Display 2]:
 - [Display 3]:
 - [Display 4]:
 - [Display 5]:
- d20: [Custom viewfinder shooting display]
 - [Display 1]: ✓ (cannot be deselected)
 - [Display 2]:
 - [Display 3]:
 - [Display 4]:
- d21: [High fps viewfinder display]: OFF
- e [Bracketing/flash]
 - e1: [Flash sync speed]: 1/200 s
 - e2: [Flash shutter speed]: 1/60 s
 - e3: [Exposure comp. for flash]: Entire frame
 - e4: [Auto ½ ISO sensitivity control]: Subject and background
 - e5: [Modeling flash]: ON
 - e6: [Auto bracketing (mode M)]: Flash/speed
 - e7: [Bracketing order]: MTR > under > over
 - e8: [Flash burst priority]: Prioritize precise flash control
- f [Controls]
 - f1: [Customize  menu]: Set Picture Control, White balance, Image quality, Image size, AF-area mode/subj. detection, Focus mode, Metering, Vibration reduction, Shooting menu bank, Custom controls (shooting), Airplane mode, View memory card info
 - f2: [Custom controls (shooting)]

- **[Fn1 button]**: Shooting menu bank
- **[Fn2 button]**: Choose image area
- **[Fn3 button]**: Live view info display off
- **[Fn button for vertical shooting]**: Exposure compensation
- **[Vertical ISO sensitivity button]**: ISO sensitivity
- **[AF-ON button]**: AF-ON
- **[Protect/Fn4 button]**: Set Picture Control
- **[DISP button]**: Cycle live view info display
- **[Sub-selector center]**: AE/AF lock
- **[OK button]**: Select center focus point
- **[Audio button]**: None
- **[QUAL button]**: Image quality/size
- **[WB button]**: White balance
- **[Playback button]**: Playback
- **[Vertical multi selector center]**: AE/AF lock
- **[AF-ON button for vertical shooting]**: Same as AF-ON button
- **[Video record button]**: None
- **[Exposure compensation button]**: Exposure compensation
- **[ISO sensitivity button]**: ISO sensitivity
- **[Command dials]**
 - **[Exposure setting]** :P: P*, S: Tv, A: Av/--, M: Av/Tv
 - **[Focus/AF-area mode selection]**: /AF/MF
 - **[Sub-command dial zoom role]**: Exposure setting
- **[Flash mode button]**: Flash mode/compensation
- **[BKT button]**: Auto bracketing
- **[Lens Fn button]**: AE/AF lock
- **[Lens Fn2 button]**: AF-ON
- **[Lens Fn ring (counterclockwise)]**: Recall focus position
- **[Lens Fn ring (clockwise)]**: Recall focus position
- **[Lens memory set button]**: Save focus position
- **[Lens control ring]**: (Varies with lens)
- f3: **[Custom controls (playback)]**
 - **[Fn1 button]**: None
 - **[Fn2 button]**: None
 - **[Fn3 button]**: None
 - **[Fn button for vertical shooting]**: None
 - **[Protect/Fn4 button]**: Protect
 - **[DISP button]**: Cycle info display
 - **[Audio button]**: Voice memo
 - **[OK button]**: Zoom on/off
 - **[WB button]**: Select for upload to computer
 - **[QUAL button]**: Rating
 - **[Vertical shooting multi selector]**: Unswitch

- [**Playback button**]: Resume shooting
- [**Main command dial**]
 - [**Frame advance**]: 1 frame
 - [**Video playback**]: 10 frames
 - [**Frame advance zoom position**]: Keep current zoom position
- [**Sub-command dial**]
 - [**Frame advance**]: 1 frame
 - [**Video playback**]: 10 s
 - [**Frame advance zoom position**]: Keep current zoom position
- [**Video record button**]: None
- [**BKT button**]: None
- [**Flash mode button**]: None
- [**Lens Fn2 button**]: None
- [**Lens Fn button**]: None
- f4: [**Control lock**]
 - [**Shutter speed lock**]: OFF
 - [**Aperture lock**]: OFF
 - [**Focus-point lock**]: OFF
- f5: [**Reverse dial rotation**]
 - [**Exposure compensation**]:
 - [**Shutter speed/aperture**]:
- f6: [**Release button to use dial**]: OFF
- f7: [**Reverse indicators**]: 
- f8: [**Reverse ring for focus**]: OFF
- f9: [**Focus ring rotation range**]: Non-linear
- f10: [**Control ring response**]: High
- f11: [**Switch focus/control ring roles**]: OFF
- f12: [**Assign power zoom buttons**]
 - [**Use @/@@ buttons**]: OFF
 - [**Power zoom speed**]: +3
- f13: [**Full-frame playback flicks**]
 - [**Flick up**]: None
 - [**Flick down**]: None
 - [**Flick advance direction**]: Left→Right
- f14: [**Prefer sub-selector center**]: ON
- **g [Video]**
 - g1: [**Customize  menu**]: Set Picture Control, White balance, Frame size/frame rate, Microphone sensitivity, AF-area mode/subj. detection, Focus mode, Electronic VR, Vibration reduction, Shooting menu bank, Custom controls, Airplane mode, Destination
 - g2: [**Custom Controls**]
 - [**Fn1 button**]: Shooting menu bank
 - [**Fn2 button**]: Choose image area
 - [**Fn3 button**]: Live view info display off

- [**Fn button for vertical shooting**]: Exposure compensation
- [**Vertical ISO sensitivity button**]: ISO sensitivity
- [**Focus mode button**]: Focus mode/AF-area mode
- [**Protect/Fn4 button**]: Set Picture Control
- [**AF-ON button**]: AF-ON
- [**Sub-selector center**]: AE/AF lock
- [**DISP button**]: Cycle live view info display
- [**Audio button**]: Microphone sensitivity
- [**OK button**]: Select center focus point
- [**WB button**]: White balance
- [**QUAL button**]: None
- [**Vertical multi selector center**]: AE/AF lock
- [**Playback button**]: Playback
- [**Video record button**]: Record videos
- [**AF-ON button for vertical shooting**]: Same as AF-ON button
- [**ISO sensitivity button**]: ISO sensitivity
- [**Exposure compensation button**]: Exposure compensation
- [**Shutter-release button**]: None
- [**Command dials**]
 - [**Exposure setting**]: A: Av/Tv, M: Av/Tv
 - [**Focus/AF-area mode selection**]: AF/MF
 - [**Sub-command dial zoom role**]: Exposure setting
- [**Flash mode button**]: None
- [**BKT button**]: None
- [**Lens Fn button**]: AE/AF lock
- [**Lens Fn2 button**]: AF-ON
- [**Lens Fn ring (counterclockwise)**]: Recall focus position
- [**Lens Fn ring (clockwise)**]: Recall focus position
- [**Lens memory set button**]: Save focus position
- [**Lens control ring**]: (Varies with lens)
- g3: [**Control lock**]
 - [**Shutter speed lock**]: OFF
 - [**Aperture lock**]: OFF
 - [**Focus-point lock**]: OFF
- g4: [**Limit AF-area mode selection**]
 - [**Single-point AF**]: ✓ (cannot be deselected)
 - [**Wide-area AF (S)**]:
 - [**Wide-area AF (L)**]:
 - [**Wide-area AF (C1)**]:
 - [**Wide-area AF (C2)**]:
 - [**Subject-tracking AF**]:
 - [**Auto-area AF**]:
- g5: [**Focus mode restrictions**]: No restrictions

- g6: **[AF speed]**: 0
 - **[When to apply]**: Always
- g7: **[AF tracking sensitivity]**: 4
- g8: **[Hi-Res Zoom speed]**: 0
- g9: **[Assign power zoom buttons]**
 - **[Use /  buttons]**: OFF
 - **[Power zoom speed]**
 - **[Pre/post recording]**: +3
 - **[During recording]**: 0
- g10: **[Fine ISO control (mode M)]**: Off
- g11: **[Extended shutter speeds (mode M)]**: OFF
- g12: **[View assist]**: OFF
- g13: **[Zebra pattern]**
 - **[Pattern tone range]**: Zebra pattern off
 - **[Pattern]**: Pattern 1
 - **[Highlight threshold]**: 250
 - **[Mid-tone range]**: Value: 160; range: ±10
- g14: **[Limit zebra pattern tone range]**: No restrictions
- g15: **[Grid type]**: 3×3
- g16: **[Brightness information display]**: Histogram
- g17: **[Custom monitor shooting display]**
 - **[Display 1]**: ✓ (cannot be deselected)
 - **[Display 2]**:
 - **[Display 3]**:
 - **[Display 4]**:
- g18: **[Custom viewfinder shooting display]**
 - **[Display 1]**: ✓ (cannot be deselected)
 - **[Display 2]**:
 - **[Display 3]**:
- g19: **[Red REC frame indicator]**: ON

Playback Menu

- [Delete]: —
- [Playback folder]: All
- [Playback display options]
 - [Focus point]:
 - [Mark first shot in series]:
 - [Exposure info]:
 - [Highlights]:
 - [RGB histogram]:
 - [Shooting data]:
 - [Overview]:
 - [None (picture only)]:
 - [File info]:
 - [Basic shooting data]:
 - [Flash data]:
 - [Picture Control/HLG data]:
 - [Other shooting data]:
 - [Copyright info]:
 - [Location data]:
 - [IPTC data]:
- [Delete pictures from both slots]: Yes (confirmation required)
- [Dual-format recording PB slot]: Slot 1
- [Filtered playback criteria]
 - [Protect]:
 - [Picture type]:
 - [Rating]:
 - [Select for upload to computer]:
 - [Select for upload (FTP)]:
 - [Voice memo]:
 - [Retouched pictures]:
- [Series playback]
 - [Sub-selector displays first shot]: ON
 - [Auto series playback]: OFF
 - [List series as single thumbnails]: OFF
- [Picture review]: Off
- [After delete]: Show next
- [After burst, show]: Last picture in burst
- [Auto-rotate pictures]: ON
- [Copy image(s)]: —

Setup Menu

- **[Format memory card]:** —
- **[Language]:** (Default varies with country of purchase)
- **[Time zone and date]**
 - **[Time zone]:** (Default varies with country of purchase)
 - **[Date and time]:** —
 - **[Date format]:** (Default varies with country of purchase)
 - **[Daylight saving time]:** OFF
- **[Monitor brightness]:** 0
- **[Monitor color balance]:** A-B: 0, G-M: 0
- **[Viewfinder brightness]:** Auto
- **[Viewfinder color balance]:** A-B: 0, G-M: 0
- **[Viewfinder display size]:** Standard
- **[Limit monitor mode selection]**
 - **[Automatic display switch]:**
 - **[Viewfinder only]:**
 - **[Monitor only]:**
 - **[Prioritize viewfinder (1)]:**
 - **[Prioritize viewfinder (2)]:**
- **[Auto rotate info display]:** ON
- **[AF fine-tuning options]**
 - **[AF fine-tune]:** OFF
 - **[Fine-tune and save lens]:** —
 - **[Default]:** —
 - **[List saved values]:** —
 - **[Choose value for current lens]:** —
- **[Non-CPU lens data]**
 - **[Lens number]:** 1
 - **[Focal length (mm)]:** --
 - **[Maximum aperture]:** --
 - **[Lens name]:** --
- **[Distance units]:** Meters (m)
- **[Save focus position]:** OFF
- **[Save zoom position (PZ lenses)]:** OFF
- **[Auto temperature cutout]:** Standard
- **[Sensor shield behavior at power off]:** Sensor shield stays open
- **[Clean image sensor]**
 - **[Automatic cleaning]:** Clean at shutdown
- **[Image Dust Off ref photo]:** —
- **[Pixel mapping]:** —
- **[Image comment]**

- [**Attach comment**]: OFF
- [**Copyright information**]
 - [**Attach copyright information**]: OFF
- [**IPTC**]
 - [**Edit/save**]: —
 - [**Delete**]: —
 - [**Auto embed during shooting**]: Off
 - [**Load/save**]: —
- [**Voice memo options**]
 - [**Voice memo control**]: Press and hold
 - [**Audio output (playback)**]: Speaker/headphones
- [**Camera sounds**]
 - [**Shutter sound**]: ON
 - [**Volume**]: 3
 - [**Type**]: Type A
 - [**Beep**]: Off
 - [**Volume**]: 2
 - [**Pitch**]: Low
- [**Silent mode**]: OFF
- [**Touch controls**]
 - [**Enable/disable touch controls**]: Enable
 - [**Glove mode**]: OFF
- [**HDMI**]
 - [**Output resolution**]: Auto
 - [**Output range**]: Auto
 - [**Output shooting info**]: ON
 - [**Mirror camera info display**]: ON
- [**USB connection priority**]: Upload
- [**Location data (built-in)**]
 - [**Record location data**]: OFF
 - [**Standby timer**]: ON
 - [**Set clock from satellite**]: OFF
 - [**Create log**]: —
 - [**Log list**]: —
 - [**Position**]: —
- [**Wireless remote (WR) options**]
 - [**LED lamp**]: ON
 - [**Link mode**]: Pairing
- [**Assign remote (WR) Fn button**]: None
- [**Conformity marking**]: —
- [**Battery info**]: —
- [**USB power delivery**]: ON
- [**Energy saving (photo mode)**]: OFF

- **[Slot empty release lock]**: Enable release
- **[Save/load menu settings]**: —
- **[Reset all settings]**: —
- **[Firmware version]**: —

Network Menu

- [Airplane mode]: OFF
- [Wired LAN]: OFF
- [Connect to smart device]
 - [Pairing (Bluetooth)]
 - [Bluetooth connection]: OFF
 - [Select pictures for upload]
 - [Auto select for upload]: ON
 - [Wi-Fi connection]: —
 - [Upload while off]: ON
 - [Location data (smart device)]: —
- [Connect to computer]
 - [Network settings]: —
 - [Connection type]: Picture transfer
 - [Options]
 - [Auto upload]: OFF
 - [Delete after upload]: OFF
 - [Upload RAW + JPEG as]: RAW + JPEG
 - [JPEG+JPEG slot selection]: Slot 1
 - [Upload RAW video as]: RAW video + MP4
 - [Upload folder]: —
 - [Deselect all?]: —
- [Connect to FTP server]
 - [Network settings]: —
 - [Options]
 - [Auto upload]: OFF
 - [Delete after upload]: OFF
 - [Upload RAW + JPEG as]: RAW + JPEG
 - [JPEG+JPEG slot selection]: Slot 1
 - [Upload RAW video as]: RAW video + MP4
 - [Overwrite if same name]: OFF
 - [Protect if marked for upload]: OFF
 - [Upload marking]: OFF
 - [Upload folder]: —
 - [Deselect all?]: —
 - [Keep connection]: OFF
 - [Manage root certificate]: —
- [Connect to other cameras]
 - [Synchronized release]: ON
 - [Network settings]: —
 - [Master/remote]: Master camera

- [Group settings]: —
- [Group name]: —
- [Synchronize date and time]: —
- [Overwrite copyright info]: —
- [ATOMOS AirGlu BT options]
 - [Connect to ATOMOS AirGlu BT]: OFF
 - [Save ATOMOS AirGlu BT pairing info]: —
 - [Delete ATOMOS AirGlu BT pairing info]: —
 - [Camera]: NCZ9
- [USB]: MTP/PTP
- [Start via LAN]: OFF
- [Router frequency band]: (Default varies with country of purchase)
- [MAC address]: —

My Menu/Recent Settings

- [Add items]: —
- [Remove items]: —
- [Rank items]: —
- [Choose tab]: MY MENU

Post-Upgrade Specifications for “C” Firmware Version 4.00

Product specifications following upgrade to “C” firmware version 4.00 are listed below.

Type	
Type	Digital camera with support for interchangeable lenses
Lens mount	Nikon Z mount
Lens	
Compatible lenses	<ul style="list-style-type: none">• Z mount NIKKOR lenses• F mount NIKKOR lenses (mount adapter required; restrictions may apply)
Effective pixels	
Effective pixels	45.7 million
Image sensor	
Type	35.9 × 23.9 mm CMOS sensor (Nikon FX format)
Total pixels	52.37 million
Dust-reduction system	Image sensor cleaning, Image Dust Off reference data (requires NX Studio)

Storage

Image size (pixels)	<ul style="list-style-type: none">• [FX (36 × 24)] selected for image area:<ul style="list-style-type: none">- 8256 × 5504 (Large: 45.4 M)- 6192 × 4128 (Medium: 25.6 M)- 4128 × 2752 (Small: 11.4 M)• [DX (24 × 16)] selected for image area:<ul style="list-style-type: none">- 5392 × 3592 (Large: 19.4 M)- 4032 × 2688 (Medium: 10.8 M)- 2688 × 1792 (Small: 4.8 M)• [1:1 (24 × 24)] selected for image area:<ul style="list-style-type: none">- 5504 × 5504 (Large: 30.3 M)- 4128 × 4128 (Medium: 17.0 M)- 2752 × 2752 (Small: 7.6 M)• [16:9 (36 × 20)] selected for image area:<ul style="list-style-type: none">- 8256 × 4640 (Large: 38.3 M)- 6192 × 3480 (Medium: 21.5 M)- 4128 × 2320 (Small: 9.6 M)
File format (image quality)	<ul style="list-style-type: none">• NEF (RAW): 14 bit; choose from lossless compression, high efficiency★, and high efficiency options• JPEG: JPEG-Baseline compliant with fine (approx. 1: 4), normal (approx. 1: 8), or basic (approx. 1: 16) compression; size-priority and optimal-quality compression available• NEF (RAW) + JPEG: Single photograph recorded in both NEF (RAW) and JPEG formats
Picture Control System	Auto, Standard, Neutral, Vivid, Monochrome, Portrait, Landscape, Flat, Creative Picture Controls (Dream, Morning, Pop, Sunday, Somber, Dramatic, Silence, Bleached, Melancholic, Pure, Denim, Toy, Sepia, Blue, Red, Pink, Charcoal, Graphite, Binary, Carbon); selected Picture Control can be modified; storage for custom Picture Controls
Media	CFexpress (Type B) and XQD memory cards
Dual card slots	The card in Slot 2 can be used for overflow or backup storage, for separate storage of NEF (RAW) and JPEG pictures, or for storage of duplicate JPEG pictures at different sizes and image qualities; pictures can be copied between cards.
File system	DCF 2.0, Exif 2.32

Viewfinder	
Viewfinder	1.27-cm/0.5-in. approx. 3690k-dot (Quad VGA) OLED electronic viewfinder with color balance, auto and 18-level manual brightness controls, and support for high frame rates
Frame coverage	Approx. 100% horizontal and 100% vertical
Magnification	Approx. 0.8× (50 mm lens at infinity, -1.0 m^{-1})
Eyepoint	23 mm (-1.0 m^{-1} ; from rearmost surface of viewfinder eyepiece lens)
Diopter adjustment	-4 – $+3 \text{ m}^{-1}$
Eye sensor	Automatically switches between monitor and viewfinder displays
Monitor	
Monitor	8-cm/3.2-in., approx. 2100k-dot vertically and horizontally tilting TFT touch-sensitive LCD with 170° viewing angle, approximately 100% frame coverage, and color balance and 15-level manual brightness controls
Shutter	
Type	Electronic shutter with shutter sound and sensor shield
Speed	$\frac{1}{32000}$ – 30 s (choose from step sizes of $\frac{1}{3}$, $\frac{1}{2}$, and 1 EV, extendable to 900 s in mode M), bulb, time
Flash sync speed	Flash synchronizes with shutter at speeds of $\frac{1}{250}$ or $\frac{1}{200}$ s or slower (but note that the guide number drops at speeds of $\frac{1}{200}$ to $\frac{1}{250}$ s); sync speeds as fast as $\frac{1}{8000}$ s are supported with auto FP high-speed sync

Release	
Release mode	Single frame, continuous low-speed, continuous high-speed, high-speed frame capture + with Pre-Release Capture, self-timer
Approximate frame advance rate	<ul style="list-style-type: none"> • Continuous low-speed: Approx. 1 – 10 fps • Continuous high-speed: Approx. 10 – 20 fps • High-speed frame capture + (C30): Approx. 30 fps • High-speed frame capture + (C60): Approx. 60 fps • High-speed frame capture + (C120): Approx. 120 fps <p>* Maximum frame advance rate as measured by in-house tests.</p>
Self-timer	2 s, 5 s, 10 s, 20 s; 1–9 exposures at intervals of 0.5, 1, 2, or 3 s

Exposure	
Metering system	TTL metering using camera image sensor
Metering mode	<ul style="list-style-type: none"> • Matrix metering • Center-weighted metering: Weight of 75% given to 12 or 8 mm circle in center of frame or weighting can be based on average of entire frame • Spot metering: Meters circle with a diameter of approximately 4 mm centered on selected focus point • Highlight-weighted metering
Range *	<p>–3 – +17 EV</p> <p>* Figures are for ISO 100 and f/2.0 lens at 20 °C/68 °F</p>
Mode	P: programmed auto with flexible program, S: shutter-priority auto, A: aperture-priority auto, M: manual
Exposure compensation	–5 – +5 EV (choose from step sizes of 1/3 and 1/2 EV)
Exposure lock	Luminosity locked at detected value
ISO sensitivity (Recommended Exposure Index)	ISO 64–25600 (choose from step sizes of 1/3 and 1 EV); can also be set to approx. 0.3, 0.7, or 1 EV (ISO 32 equivalent) below ISO 64 or to approx. 0.3, 0.7, 1, or 2 EV (ISO 102400 equivalent) above ISO 25600; auto ISO sensitivity control available
Active D-Lighting	Auto, Extra high 2, Extra high 1, High, Normal, Low, and Off
Multiple exposure	Add, average, lighten, darken
Other options	HDR overlay, photo flicker reduction, high-frequency flicker reduction

Autofocus	
Type	Hybrid phase-detection/contrast AF with AF assist
Detection range *	-7 – +19 EV (-9 – +19 EV with starlight view) * Measured in photo mode at ISO 100 and a temperature of 20 °C/68 °F using single-servo AF (AF-S) and a lens with a maximum aperture of f/1.2
Lens servo	<ul style="list-style-type: none"> • Autofocus (AF): Single-servo AF (AF-S); continuous-servo AF (AF-C); full-time AF (AF-F; available only in video mode); predictive focus tracking • Manual focus (M): Electronic rangefinder can be used
Focus points *	493 focus points * Number of focus points available in photo mode with single-point AF selected for AF-area mode and FX selected for image area
AF-area mode	Pinpoint (available in photo mode only), single-point, dynamic-area (S, M, and L; available in photo mode only), wide-area (S, L, C1, and C2), and auto-area AF; 3D-tracking (available in photo mode only); subject-tracking AF (available in video mode only)
Focus lock	Focus can be locked by pressing shutter-release button halfway (single-servo AF/ AF-S) or by pressing the center of the sub-selector
Vibration reduction (VR)	
Camera on-board VR	5-axis image sensor shift
Lens on-board VR	Lens shift (available with VR lenses)

Flash	
Flash control	TTL: i-TTL flash control; i-TTL balanced fill-flash is used with matrix, center-weighted, and highlight-weighted metering, standard i-TTL fill-flash with spot metering
Flash mode	Front-curtain sync, slow sync, rear-curtain sync, red-eye reduction, red-eye reduction with slow sync, off
Flash compensation	-3 – +1 EV (choose from step sizes of $\frac{1}{3}$ and $\frac{1}{2}$ EV)
Flash-ready indicator	Lights when optional flash unit is fully charged; flashes as underexposure warning after flash is fired at full output
Accessory shoe	ISO 518 hot-shoe with sync and data contacts and safety lock
Nikon Creative Lighting System (CLS)	i-TTL flash control, radio-controlled Advanced Wireless Lighting, optical Advanced Wireless Lighting, modeling illumination, FV lock, Color Information Communication, auto FP high-speed sync, unified flash control
Sync terminal	ISO 519 sync terminal with locking thread
White balance	
White balance	Auto (3 types), natural light auto, direct sunlight, cloudy, shade, incandescent, fluorescent (3 types), flash, choose color temperature (2500–10,000 K), preset manual (up to 6 values can be stored), all with fine-tuning
Bracketing	
Bracketing	Exposure and/or flash, white balance, and ADL
Other options for still photography	
Other options for still photography	Vignette control, diffraction compensation, auto distortion control, interval-timer photography, focus-shift photography, and auto capture

Video	
Metering system	TTL metering using camera image sensor
Metering mode	Matrix, center-weighted, or highlight-weighted
Frame size (pixels) and frame rate	<ul style="list-style-type: none"> • 7680 × 4320 (8K UHD): 30p (progressive)/25p/24p • 3840 × 2160 (4K UHD): 120p/100p/60p/50p/30p/25p/24p • 1920 × 1080: 120p/100p/60p/50p/30p/25p/24p • 1920 × 1080 (slow-motion): 30p (4×)/25p (4×)/24p (5×) <p>* Actual frame rates for 120p, 100p, 60p, 50p, 30p, 25p, and 24p are 119.88, 100, 59.94, 50, 29.97, 25, and 23.976 fps respectively</p>
Frame size (pixels) and frame rate (RAW video)	<ul style="list-style-type: none"> • 8256 × 4644: 60p/50p/30p/25p/24p • 5392 × 3032: 60p/50p/30p/25p/24p • 4128 × 2322: 120p/100p/60p/50p/30p/25p/24p • 3840 × 2160: 120p/100p/60p/50p <p>* Actual frame rates for 120p, 100p, 60p, 50p, 30p, 25p, and 24p are 119.88, 100, 59.94, 50, 29.97, 25, and 23.976 fps respectively</p>
File format	NEV, MOV, MP4
Video compression	N-RAW (12 bit), Apple ProRes RAW HQ (12 bit), Apple ProRes 422 HQ (10 bit), H.265/HEVC (8 bit/10 bit), H.264/AVC (8 bit)
Audio recording format	Linear PCM (48 KHz, 24 bit, for videos recorded in NEV or MOV format) or AAC (48 KHz, 16 bit, for videos recorded in MP4 format)
Audio recording device	Built-in stereo or external microphone with attenuator option; sensitivity adjustable
Exposure compensation	-3 – +3 EV (choose from step sizes of $\frac{1}{3}$ and $\frac{1}{2}$ EV)
ISO sensitivity (Recommended Exposure Index)	<ul style="list-style-type: none"> • Mode M: Manual selection (ISO 64–25600; choose from step sizes of $\frac{1}{6}$, $\frac{1}{3}$ and 1 EV); with additional options available equivalent to approximately 0.3, 0.7, 1, or 2 EV (ISO 102400 equivalent) above ISO 25600; auto ISO sensitivity control (ISO 64–Hi 2.0) available with selectable upper limit • Modes P, S, A: Auto ISO sensitivity control (ISO 64–Hi 2.0) with selectable upper limit
Active D-Lighting	Extra high, High, Normal, Low, and Off

Video	
Other options for video recording	Time-lapse video recording, electronic vibration reduction, time codes, N-Log and HDR (HLG) video, wave-form display, red REC frame indicator, video recording display zoom (50%, 100%, and 200%), extended shutter speeds (mode M), and dual-format (proxy-video) recording for RAW video; extended oversampling available; option to view video recording info available via z menu; Hi-Res Zoom; auto capture
Playback	
Playback	Full-frame and thumbnail (up to 4, 9, or 72 pictures) playback with playback zoom, playback zoom cropping, video playback, slide shows, histogram display, highlights, photo information, location data display, auto picture rotation, picture rating, voice memo recording and playback, IPTC information embedding and display, filtered playback, skip to first shot in series, series playback, save consecutive frames, and motion blend

Interface	
USB	Type C SuperSpeed USB connector; connection to built-in USB ports is recommended
HDMI output	Type A HDMI connector
Audio input	Stereo mini-pin jack (3.5 mm diameter; plug-in power supported)
Audio output	Stereo mini-pin jack (3.5 mm diameter)
Ten-pin remote terminal	Built-in (can be used with MC-30A/MC-36A remote cords and other optional accessories)
Wired LAN	<p>RJ-45 connector</p> <ul style="list-style-type: none"> • Standards: IEEE 802.3ab (1000BASE-T), IEEE 802.3u (100BASE-TX), IEEE 802.3 (10BASE-T) • Data rates *: 1000/100/10 Mbps with auto detect • Port: 1000BASE-T/100BASE-TX/10BASE-T (AUTO-MDIX) <p>* Maximum logical data rates according to IEEE standard; actual rates may differ.</p>
Wi-Fi/Bluetooth	
Wi-Fi	<ul style="list-style-type: none"> • Standards: <ul style="list-style-type: none"> - IEEE 802.11b/g/n (Africa, Asia, and Oceania) - IEEE 802.11b/g/n/a/ac (Europe, U.S.A., Canada, Mexico) - IEEE 802.11b/g/n/a (other countries in the Americas) • Operating frequency: <ul style="list-style-type: none"> - 2412–2462 MHz (channel 11; Africa, Asia, and Oceania) - 2412–2462 MHz (channel 11) and 5180–5825 MHz (U.S.A., Canada, Mexico) - 2412–2462 MHz (channel 11) and 5180–5805 MHz (other countries in the Americas) - 2412–2462 MHz (channel 11) and 5745–5805 MHz (Georgia) - 2412–2462 MHz (channel 11) and 5180–5320 MHz (other European countries) • Maximum output power (EIRP): <ul style="list-style-type: none"> - 2.4 GHz band: 8.4 dBm - 5 GHz band: 6.0 dBm (Georgia) - 5 GHz band: 9.0 dBm (other countries) • Authentication: Open system, WPA2-PSK, WPA3-SAE

Bluetooth	<ul style="list-style-type: none">• Communication protocols: Bluetooth Specification version 5.0• Operating frequency:<ul style="list-style-type: none">- Bluetooth: 2402–2480 MHz- Bluetooth Low Energy: 2402–2480 MHz• Maximum output power (EIRP):<ul style="list-style-type: none">- Bluetooth: 2.9 dBm- Bluetooth Low Energy: 1.4 dBm
Range (line of sight)	Approximately 10 m (32 ft) * * Without interference. Range may vary with signal strength and presence or absence of obstacles.

Location Data	
Supported GNS systems	GPS (USA), GLONASS (Russia), QZSS (Japan)
Data acquired	Latitude, longitude, altitude, UTC (Universal Coordinated Time)
Clock synchronization	Camera clock can be set to time acquired via GNSS
Track logs	NMEA-compliant
Log interval	15 s, 30 s, 1 min., 2 min., 5 min.
Maximum log recording time	6, 12, or 24 hours
Log deletion	Supported
Power source	
Battery	One EN-EL18d rechargeable Li-ion battery * * EN-EL18c, EN-EL18b, EN-EL18a, and EN-EL18 batteries can also be used. Note, however, that fewer pictures can be taken on a single charge than with the EN-EL18d. The EH-7P charging AC adapter can be used to charge EN-EL18d, EN-EL18c, and EN-EL18b batteries only.
Charging AC adapter	EH-7P charging AC adapter
AC adapter	EH-6d; requires EP-6a power connector (available separately)
Tripod socket	
Tripod socket	0.635 cm (1/4 in., ISO 1222)

Dimensions/weight	
Dimensions (W × H × D)	Approx. 149 × 149.5 × 90.5 mm/5.9 × 5.9 × 3.6 in.
Weight	Approx. 1340 g (2 lb. 15.3 oz.) with battery and memory card but without body cap and accessory shoe cover; approx. 1160 g/2 lb. 9 oz. (camera body only)
Operating environment	
Temperature	−10 °C– 40 °C (+14 °F– 104 °F)
Humidity	85% or less (no condensation)

- Unless otherwise stated, all measurements are performed in conformity with Camera and Imaging Products Association (CIPA) standards or guidelines.
- All figures are for a camera with a fully-charged battery.
- The sample images displayed on the camera and the images and illustrations in this document are for expository purposes only.
- Nikon reserves the right to change the appearance and specifications of the hardware and software described in this document at any time and without prior notice. Nikon will not be held liable for damages that may result from any mistakes that this document may contain.

Changes with “C” Firmware Version 4.10

Changes Made with “C” Firmware Version 4.10

This chapter details the new features and changes introduced with camera “C” firmware version 4.10. Read it together with the chapter on “C” firmware version 4.00 ([📖 937](#)).

New AF Subject Detection Options: Birds and Airplanes

[**Birds**] and [**Airplanes**] have been added to the subject detection options available in [**AF subject detection options**] in the photo shooting and video recording menus.

- In the case of the video recording menu, the choice of subject is made via [**AF subject detection options**] > [**Subject detection**]. Separate subject types can be selected for photo and video modes.
- If a bird is detected when [**Birds**] is selected, the focus point will appear over the face of the bird in question. If the camera detects the subject's eyes, the focus point will instead appear over one or the other of their eyes. If the camera can detect neither face nor eyes, it will display a focus point over the detected bird.
- If an aircraft is detected when [**Airplanes**] is selected, the focus point will appear over the aircraft in question. The camera will detect the body, nose, or cockpit depending on the aircraft's size.

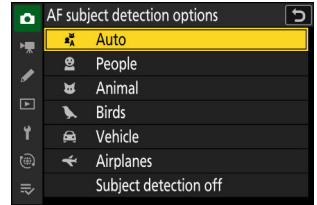

✓ **Cautions: Subject Detection Using “Birds”**

- Subject detection may not perform as expected if:
 - the subject’s face is too large or small relative to the frame,
 - the subject’s face is too brightly or dimly lit,
 - the subject’s face or eyes are obscured by feather or the like,
 - the subject’s face and eyes are of similar colors, or
 - the subject moves excessively during shooting.
- The camera may display a border around subjects that are not birds, but which resemble them. If the camera often mistakenly detects the subjects other than birds, changing to an AF-area mode with smaller focus points may improve focus performance.
- Flickering is more likely to occur if photos are taken under fluorescent, mercury-vapor, or similar lighting, compared to other environments.
 - Selecting **[ON]** for **[Photo flicker reduction]** in the photo shooting menu reduces flickering effects.
 - We recommend selecting **[OFF]** for **[Photo flicker reduction]** in the photo shooting menu if there is no flickering.
- The light from the AF-assist illuminator may adversely affect the eyes of some birds; select **[OFF]** for Custom Setting a12 **[Built-in AF-assist illuminator]** when using autofocus.
- “Birds” cannot be selected as a subject detection option for **[Auto capture]** in the photo shooting and video recording menus. Choose auto or animals as the subject type when taking pictures of birds.

























✓ **Cautions: Subject Detection Using “Airplanes”**



- Subject detection may not perform as expected with subjects that are:
 - too large or small relative to the frame,
 - too bright or too dark,
 - partially hidden,
 - similar in color to surrounding objects, or
 - moving excessively.
 - The camera may fail to detect airplanes of some shapes and colors. Alternatively, it may display a border around subjects that are not airplanes.
 - “Airplanes” cannot be selected as a subject detection option for **[Auto capture]** in the photo shooting and video recording menus. Choose auto or vehicles as the subject type when taking pictures of airplanes.
-

Index

Index

Symbols, Numerics

P (Programmed auto) ([128](#))
S (Shutter-priority auto) ([128](#))
A (Aperture-priority auto) ([128](#))
M (Manual) ([129](#))
 (Single frame) ([139](#))
 **L** (Continuous low-speed) ([139](#))
 **H** (Continuous high-speed) ([139](#))
 (Self-timer) ([139](#), [145](#))
 (Quick release-mode selection) ([139](#), [141](#))
 (Pinpoint AF) ([112](#))
 [] (Single-point AF) ([112](#))
 **S** (Dynamic-area AF (S)) ([113](#))
 **M** (Dynamic-area AF (M)) ([113](#))
 **L** (Dynamic-area AF (L)) ([113](#))
 **S** (Wide-area AF (S)) ([113](#))
 **L** (Wide-area AF (L)) ([113](#))
 **C1** (Wide-area AF (C1)) ([114](#))
 **C2** (Wide-area AF (C2)) ([114](#))
 **3D** (3D-tracking) ([114](#))
 (Subject-tracking AF) ([114](#))
 (Auto-area AF) ([114](#))
 (Matrix metering) ([470](#))
 (Center-weighted metering) ([470](#))
 (Spot metering) ([470](#))
 * (Highlight-weighted metering) ([470](#))
i Button ([72](#))
i Menu ([72](#))
 (Fn) button ([103](#))
 button ([141](#))
 button ([409](#))
 button ([137](#))

 button ([292](#))
 (**Fn4**) button ([183](#), [248](#))
 (Help) ([70](#))
1:1 (24×24) (Image area) ([105](#))
16:9 (36×20) (Image area) ([105](#))
1920×1080; 24p ×5 (slow-motion) ([963](#))
1920×1080; 25p ×4 (slow-motion) ([963](#))
1920×1080; 30p ×4 (slow-motion) ([963](#))
3D-tracking ([114](#))

A

AC adapter ([889](#))
Access-point mode ([322](#), [351](#))
Active D-Lighting ([459](#), [539](#))
ADL bracketing (Auto bracketing set) ([170](#))
AE & flash bracketing (Auto bracketing set) ([170](#), [940](#))
AE bracketing (Auto bracketing set) ([171](#), [940](#))
AE-L icon ([135](#))
AF activation ([577](#))
AF fine-tuning options ([735](#))
AF speed ([686](#))
AF subject detection options ([116](#), [549](#), [1031](#))
AF tracking sensitivity ([687](#))
AF-area mode ([112](#))
AF-C ([110](#))
AF-C priority selection ([571](#))
AF-F ([111](#))
AF-ON button ([123](#))
AF-S ([110](#))

AF-S priority selection ([📖 572](#))
After burst, show ([📖 713](#))
After delete ([📖 712](#))
Airplane mode ([📖 781](#))
All pictures ([📖 259](#))
Aperture ([📖 128](#), [📖 129](#))
Aperture-priority auto ([📖 128](#))
Assign Power Zoom Buttons ([📖 967](#), [📖 967](#))
Assign remote (WR) Fn button ([📖 765](#))
ATOMOS AirGlu BT options ([📖 800](#))
Attaching a lens ([📖 88](#))
Attenuator ([📖 553](#))
Auto (Set Picture Control) ([📖 183](#))
Auto (White balance) ([📖 151](#))
Auto bracketing ([📖 170](#), [📖 940](#))
Auto bracketing (mode M) ([📖 631](#))
Auto capture ([📖 943](#))
Auto Capture Settings Display ([📖 943](#))
Auto distortion control ([📖 465](#), [📖 543](#))
Auto ⚡ ISO sensitivity control ([📖 629](#))
Auto ISO sensitivity control ([📖 149](#))
Auto rotate info display ([📖 734](#))
Auto select for upload ([📖 343](#), [📖 377](#))
Auto temperature cutout ([📖 741](#))
Auto-area AF ([📖 114](#))
Autoexposure Lock ([📖 135](#))
Auto-rotate pictures ([📖 714](#))

B

Backup (Role played by card in Slot 2) ([📖 447](#))
Basic information ([📖 229](#))
Battery ([📖 79](#), [📖 83](#))
Battery charger ([📖 79](#))
Battery info ([📖 767](#))
BKT button ([📖 171](#), [📖 176](#), [📖 179](#))
Bluetooth ([📖 306](#))
Bracketing ([📖 171](#), [📖 176](#), [📖 179](#))
Bracketing order ([📖 632](#))
Brightness (Set Picture Control) ([📖 186](#))

Brightness information display ([📖 696](#))
Built-in AF-assist illuminator ([📖 584](#))
Bulb ([📖 132](#))
Bulb (Long time-exposures) ([📖 132](#))
Burst photography ([📖 139](#))

C

C30 ([📖 142](#))
C60 ([📖 142](#))
C120 ([📖 142](#))
Calibration ([📖 887](#))
Camera control ([📖 346](#))
Camera Control Pro 2 ([📖 346](#))
Camera sounds ([📖 756](#), [📖 976](#))
Candidates for deletion ([📖 258](#))
Center-weighted area ([📖 592](#))
Center-weighted metering ([📖 470](#))
Charging AC adapter ([📖 81](#))
Choose color temperature (White balance) ([📖 152](#))
Choose image area ([📖 105](#))
Clarity (Set Picture Control) ([📖 186](#))
Clean image sensor ([📖 743](#), [📖 894](#))
Cloudy (White balance) ([📖 152](#))
Color space ([📖 458](#))
Color temperature ([📖 155](#), [📖 161](#))
Conformity marking ([📖 766](#))
Connect to computer ([📖 787](#))
Connect to FTP server ([📖 377](#), [📖 792](#), [📖 979](#))
Connect to other cameras ([📖 798](#), [📖 980](#), [📖 997](#))
Connect to smart device ([📖 783](#))
Continuous AF ([📖 110](#))
Continuous high-speed ([📖 139](#))
Continuous low-speed ([📖 139](#))
Continuous shooting speed ([📖 598](#))
Contrast (Set Picture Control) ([📖 186](#))
Control lock ([📖 660](#), [📖 683](#))
Control ring ([📖 124](#))

Control ring response ([📖 666](#))
Copy image(s) ([📖 715](#))
Copyright information ([📖 748](#))
Creative Picture Control ([📖 184](#))
Custom controls ([📖 674](#), [📖 970](#))
Custom controls (playback) ([📖 654](#), [📖 972](#))
Custom controls (shooting) ([📖 637](#), [📖 970](#))
Custom monitor shooting display ([📖 621](#),
[📖 697](#))
Custom Settings ([📖 562](#))
Custom Settings bank ([📖 570](#))
Custom viewfinder shooting display ([📖 623](#),
[📖 699](#))

D

Darken ([📖 279](#))
Delete ([📖 103](#), [📖 256](#), [📖 703](#))
Delete pictures from both slots ([📖 707](#))
Destination ([📖 528](#))
Detaching lenses ([📖 90](#))
Diffraction compensation ([📖 464](#), [📖 542](#))
Diopter adjustment control ([📖 58](#))
Direct sunlight (White balance) ([📖 152](#))
DISP button ([📖 49](#), [📖 53](#), [📖 228](#))
Distance units ([📖 978](#))
Distortion control ([📖 274](#))
D-Lighting ([📖 273](#))
Dual-format recording PB slot ([📖 708](#))
DX (24×16) (Image area) ([📖 105](#))
DX format ([📖 105](#))
DX-based video format ([📖 214](#))
Dynamic-area AF (L) ([📖 113](#))
Dynamic-area AF (M) ([📖 113](#))
Dynamic-area AF (S) ([📖 113](#))

E

Easy Connect ([📖 329](#), [📖 360](#), [📖 387](#))
Easy exposure compensation ([📖 590](#))
Effect level (Set Picture Control) ([📖 186](#))
Electronic VR ([📖 551](#))
Encryption key ([📖 331](#), [📖 362](#), [📖 389](#))
Energy saving (photo mode) ([📖 771](#))
Ethernet connection ([📖 335](#), [📖 368](#))
EV steps for exposure cntrl ([📖 589](#))
Exposure ([📖 135](#), [📖 137](#), [📖 170](#))
Exposure comp. for flash ([📖 628](#))
Exposure compensation ([📖 137](#))
Exposure delay mode ([📖 969](#))
Exposure indicators ([📖 130](#))
Exposure info ([📖 230](#))
Extended menu banks ([📖 441](#))
Extended oversampling ([📖 533](#))
Extended shutter speeds (M) ([📖 604](#))
Extended shutter speeds (mode M) ([📖 690](#))
External rec. cntrl (HDMI) ([📖 560](#))
External recorder ([📖 297](#))

F

File info ([📖 239](#))
File naming ([📖 446](#), [📖 527](#))
File number sequence ([📖 606](#))
Fill flash ([📖 409](#))
Filter effects (Set Picture Control) ([📖 186](#))
Filtered playback ([📖 252](#))
Filtered playback criteria ([📖 252](#), [📖 709](#))
Finder display size (photo Lv) ([📖 732](#))
Fine ISO control (mode M) ([📖 689](#))
Fine-tune optimal exposure ([📖 593](#))
Firmware version ([📖 778](#), [📖 937](#))
Flange-back distance ([📖 126](#))
Flash (White balance) ([📖 152](#))
Flash bracketing (Auto bracketing set) ([📖 170](#),
[📖 940](#))

Flash burst priority ([📖 633](#))
Flash compensation ([📖 411](#))
Flash control ([📖 471](#))
Flash control mode ([📖 407](#))
Flash mode ([📖 409](#))
Flash off ([📖 410](#))
Flash photography ([📖 403](#))
Flash shutter speed ([📖 627](#))
Flash sync speed ([📖 625](#))
Flat (Set Picture Control) ([📖 184](#))
Fluorescent (White balance) ([📖 152](#))
Focal plane mark ([📖 126](#))
Focus indicator ([📖 125](#))
Focus lock ([📖 122](#))
Focus mode ([📖 110](#), [📖 124](#))
Focus mode restrictions ([📖 580](#), [📖 685](#))
Focus peaking ([📖 126](#), [📖 585](#))
Focus point ([📖 119](#))
Focus point display ([📖 582](#))
Focus point persistence ([📖 578](#))
Focus point selection speed ([📖 586](#))
Focus point wrap-around ([📖 581](#))
Focus points used ([📖 574](#))
Focus ring ([📖 124](#))
Focus ring rotation range ([📖 665](#))
Focus shift shooting ([📖 514](#))
Focus tracking with lock-on ([📖 573](#))
Format memory card ([📖 724](#))
Frame rate ([📖 205](#))
Frame size/frame rate ([📖 205](#))
Frequency response ([📖 554](#))
Full format ([📖 725](#))
Full-frame playback ([📖 225](#))
Full-frame playback flicks ([📖 668](#))
Full-time AF ([📖 111](#))
FV lock ([📖 412](#))
FX (36×24) (Image area) ([📖 105](#))
FX format ([📖 105](#))
FX-based video format ([📖 214](#))

G

Grid type ([📖 617](#), [📖 695](#))
Group settings ([📖 980](#))

H

HDMI ([📖 295](#), [📖 760](#))
HDR overlay ([📖 487](#))
Headphone volume ([📖 557](#))
Hi (ISO sensitivity) ([📖 148](#))
Hi-Res Zoom ([📖 223](#), [📖 561](#))
Hi-Res Zoom speed ([📖 688](#), [📖 962](#))
High FPS viewfinder display ([📖 624](#))
High ISO NR ([📖 462](#), [📖 540](#))
High sensitivity (Hi) ([📖 148](#))
High-frequency flicker reduction ([📖 468](#), [📖 545](#))
High-speed frame capture + ([📖 142](#), [📖 601](#),
[📖 941](#))
High-temperature warning ([📖 741](#))
Highlight display ([📖 231](#))
Highlight-weighted metering ([📖 470](#))
Histogram ([📖 231](#))
HLG ([📖 218](#))
HLG quality ([📖 538](#))
HLG video ([📖 218](#))
Hue (Set Picture Control) ([📖 186](#))

I

Image area ([📖 104](#), [📖 212](#))
Image comment ([📖 747](#))
Image Dust Off ref photo ([📖 744](#))
Image frame ([📖 616](#))
Image quality ([📖 106](#))
Image size ([📖 108](#))
Image size settings ([📖 104](#))
Incandescent (White balance) ([📖 152](#))

Infrastructure mode ([📖 328](#), [📖 358](#))

Interval timer shooting ([📖 492](#))

IPTC ([📖 749](#))

IPTC presets ([📖 975](#))

ISO (ISO) button ([📖 147](#))

ISO sensitivity ([📖 147](#))

ISO sensitivity settings ([📖 454](#), [📖 534](#))

ISO sensitivity step value ([📖 588](#))

J

JPEG Slot 1 - JPEG Slot 2 (Role played by card in Slot 2) ([📖 447](#), [📖 942](#))

K

Keep exp. when f/ changes ([📖 594](#))

L

Landscape (Set Picture Control) ([📖 184](#))

Language ([📖 726](#))

LCD illumination ([📖 612](#))

LCD Illuminator ([📖 44](#), [📖 612](#))

Lighten ([📖 279](#))

Limit AF-area mode selection ([📖 579](#), [📖 684](#))

Limit monitor mode selection ([📖 733](#))

Limit release mode selection ([📖 600](#))

Limit selectable image area ([📖 605](#))

Limit zebra pattern tone range ([📖 694](#))

Lo (ISO) ([📖 148](#))

Location data ([📖 193](#))

Location data (built-in) ([📖 193](#), [📖 762](#))

Location data (smart device) ([📖 786](#))

Log recording ([📖 221](#))

Long exposure NR ([📖 461](#))

Long time-exposures ([📖 132](#))

Low sensitivity (Lo) ([📖 148](#))

M

MAC address ([📖 805](#))

Manage Picture Controls ([📖 189](#))

Manual (Shooting mode) ([📖 129](#))

Manual focus ([📖 111](#), [📖 124](#))

Manual focus ring in AF mode ([📖 587](#))

Matrix metering ([📖 470](#))

Matrix metering face detection ([📖 591](#))

Maximum shots per burst ([📖 599](#))

Memory card ([📖 86](#), [📖 920](#))

Memory card capacity ([📖 921](#))

Memory recall ([📖 649](#))

MENU Button ([📖 65](#))

Metering ([📖 470](#))

MF (Manual focus) ([📖 111](#), [📖 124](#))

Mic jack plug-in power ([📖 556](#))

Microphone (for voice memos) ([📖 292](#))

Microphone sensitivity ([📖 552](#))

Mid-range sharpening (Set Picture Control) ([📖 186](#))

Mired ([📖 160](#))

MODE button ([📖 127](#))

Modeling flash ([📖 630](#))

Monitor brightness ([📖 728](#))

Monitor color balance ([📖 729](#))

Monochrome ([📖 276](#))

Monochrome (Set Picture Control) ([📖 183](#))

Motion blend ([📖 283](#))

Multiple exposure ([📖 479](#))

My Menu ([📖 807](#))

N

Natural light auto (White balance) ([📖 152](#))

NEF (RAW) processing ([📖 263](#))

Network menu ([📖 779](#))
Network settings (Connect to computer) ([📖 787](#))
Network settings (Connect to FTP server) ([📖 792](#))
Neutral (Set Picture Control) ([📖 183](#))
N-Log ([📖 221](#), [📖 961](#))
Non-CPU lens data ([📖 739](#), [📖 974](#))
N-RAW 12-bit (NEV) ([📖 202](#))
NX Studio ([📖 316](#))

O

On-camera flash photography ([📖 403](#))
Overflow (Role played by card in Slot 2) ([📖 447](#))
Overlay (add) ([📖 277](#))
Overview ([📖 237](#))
Overwrite copyright info ([📖 997](#))

P

Pairing (Bluetooth) ([📖 783](#))
Perspective control ([📖 275](#))
Photo flicker reduction ([📖 466](#))
Photo information ([📖 228](#))
Photo shooting menu ([📖 436](#))
Photo/video selector ([📖 93](#), [📖 97](#))
Picture review ([📖 711](#))
Pictures shot on selected dates ([📖 258](#))
PIN-entry WPS ([📖 329](#), [📖 360](#), [📖 387](#))
Pinpoint AF ([📖 112](#))
Pixel mapping ([📖 746](#))
Playback display options ([📖 705](#))
Playback folder ([📖 704](#))
Playback menu ([📖 701](#))
Playback zoom ([📖 246](#))
Portrait (Set Picture Control) ([📖 184](#))
Power connector ([📖 889](#))
Power off delay ([📖 85](#), [📖 597](#))

Pre-Release Capture options ([📖 601](#), [📖 941](#))
Prefer sub-selector center ([📖 670](#))
Preset manual (White balance) ([📖 153](#), [📖 165](#))
Press the shutter-release button all the way down ([📖 94](#))
Press the shutter-release button halfway ([📖 94](#))
Programmed auto ([📖 128](#))
ProRes RAW HQ 12-bit (MOV) ([📖 202](#))
Protect ([📖 248](#))
Push-button WPS ([📖 329](#), [📖 360](#), [📖 387](#))

Q

QUAL button ([📖 108](#), [📖 106](#))
Quick crop ([📖 240](#))
Quick format ([📖 725](#))
Quick release-mode selection ([📖 139](#), [📖 141](#))
Quick sharp (Set Picture Control) ([📖 186](#))

R

Rating ([📖 250](#))
RAW recording ([📖 453](#))
RAW Slot 1 - JPEG Slot 2 (Role played by card in Slot 2) ([📖 447](#))
Rear-curtain sync ([📖 410](#))
Recall focus position ([📖 649](#))
Recent settings ([📖 812](#))
Rechargeable Li-ion battery ([📖 79](#))
Red REC frame indicator ([📖 700](#))
Red-eye reduction ([📖 409](#))
Release button to use dial ([📖 662](#))
Release mode ([📖 139](#))
Release timing indicator ([📖 615](#))
Remote flash photography ([📖 414](#))
Remote photography ([📖 305](#))
Reset ([📖 197](#), [📖 440](#), [📖 570](#))
Reset all settings ([📖 777](#))

Resize ([📖 269](#))
Retouch ([📖 260](#))
Reverse dial rotation ([📖 661](#))
Reverse indicators ([📖 663](#))
Reverse ring for focus ([📖 664](#))
RGB histogram ([📖 696](#))
Role played by card in Slot 2 ([📖 447](#), [📖 942](#))
Router frequency band ([📖 804](#))

S

Saturation (Set Picture Control) ([📖 186](#))
Save focus position ([📖 649](#), [📖 740](#))
Save/load menu settings ([📖 773](#))
Save Zoom Position (PZ Lenses) ([📖 968](#))
Security Slot ([📖 45](#))
Select for priority upload (FTP) ([📖 966](#))
Select for priority upload to computer ([📖 966](#))
Select for upload (FTP) ([📖 376](#), [📖 965](#))
Select for upload to computer ([📖 341](#), [📖 965](#))
Select pictures for upload ([📖 251](#))
Select pictures for upload (Connect to smart device) ([📖 784](#))
Selected pictures ([📖 257](#))
Self-timer ([📖 139](#), [📖 145](#), [📖 596](#))
Sensor shield behavior at power off ([📖 742](#))
Series playback ([📖 710](#))
Set Picture Control ([📖 183](#))
Set the clock ([📖 91](#))
Setup menu ([📖 721](#))
Shade (White balance) ([📖 152](#))
Sharpening (Set Picture Control) ([📖 186](#))
Shooting data ([📖 233](#))
Shooting menu bank ([📖 439](#))
Shooting mode ([📖 127](#))
Shutter speed ([📖 128](#), [📖 129](#))
Shutter-priority auto ([📖 128](#))
Shutter-release button AE-L ([📖 595](#))
Silent mode ([📖 758](#))
Single AF ([📖 110](#))

Single frame ([📖 139](#))
Single-point AF ([📖 112](#))
Slide show ([📖 254](#))
Slot empty release lock ([📖 772](#))
Slow-motion videos ([📖 963](#))
Slow sync ([📖 409](#))
SnapBridge ([📖 304](#))
Spot metering ([📖 470](#))
Standard (Set Picture Control) ([📖 183](#))
Standby timer ([📖 85](#))
Starlight view (photo Lv) ([📖 610](#))
Start via LAN ([📖 803](#))
Stereo microphone (for videos) ([📖 97](#))
Storage folder ([📖 442](#))
Store points by orientation ([📖 575](#))
Straighten ([📖 273](#))
Sub-selector ([📖 119](#), [📖 135](#))
Subject-tracking AF ([📖 114](#))
Switch focus/control ring roles ([📖 667](#))
Sync. release mode options ([📖 603](#))
Synchronized release ([📖 386](#), [📖 980](#))

T

Thumbnail playback ([📖 226](#))
Time ([📖 132](#))
Time (Long time-exposures) ([📖 132](#))
Time zone and date ([📖 91](#), [📖 727](#))
Timecode ([📖 558](#))
Time-lapse video ([📖 503](#))
Toning (Set Picture Control) ([📖 186](#))
Touch controls ([📖 59](#), [📖 759](#))
Touch shutter ([📖 120](#))
Trim ([📖 268](#))
Trim video ([📖 285](#))
Two-button reset ([📖 197](#))

U

UltraSync BLUE ([📖 800](#))
Upload while off ([📖 786](#))
USB ([📖 802](#))
USB cable ([📖 27](#))
USB connection priority ([📖 761](#))
USB power delivery ([📖 769](#))

V

Vibration reduction ([📖 477](#))
Video file type ([📖 202](#))
Video flicker reduction ([📖 544](#))
Video quality (N-RAW) ([📖 202](#), [📖 531](#))
Video recording menu ([📖 522](#))
Video-record button ([📖 97](#))
View all in continuous mode ([📖 614](#))
View assist ([📖 691](#))
View mode (photo Lv) ([📖 608](#))
Viewfinder brightness ([📖 730](#))
Viewfinder color balance ([📖 731](#))
Viewfinder display size ([📖 977](#))
Vignette control ([📖 463](#), [📖 541](#))
Virtual horizon type ([📖 618](#))
Vivid (Set Picture Control) ([📖 183](#))
Voice memo ([📖 292](#))

Voice memo options ([📖 754](#))

W

Warm display colors ([📖 611](#))
Wave-form monitor ([📖 696](#))
WB bracketing ([📖 170](#))
WB button ([📖 151](#))
White balance ([📖 151](#))
Wide-area AF (C1) ([📖 114](#))
Wide-area AF (C2) ([📖 114](#))
Wide-area AF (L) ([📖 113](#))
Wide-area AF (S) ([📖 113](#))
Wi-Fi connection ([📖 785](#))
Wi-Fi mode ([📖 310](#))
Wind noise reduction ([📖 555](#))
Wired LAN ([📖 782](#))
Wireless LAN ([📖 322](#), [📖 351](#))
Wireless remote (WR) options ([📖 763](#))
Wireless Transmitter Utility ([📖 321](#))
WR-R10 ([📖 415](#), [📖 763](#))
WR-R11a ([📖 415](#), [📖 763](#))

Z

Zebra pattern ([📖 692](#))

No reproduction in any form of this document, in whole or in part (except for brief quotation in critical articles or reviews), may be made without written authorization from NIKON CORPORATION.