

Interchangeable Lens Digital Camera

α7SIII

E-mount

Operating Instructions



“Help Guide” (Web manual)

Refer to “Help Guide” for in-depth instructions on the many functions of the camera.

https://rd1.sony.net/help/ilc/2410/h_zz/

Check out the Help Guide!



The “Help Guide” is an on-line manual that you can read on your computer or smartphone. Refer to it for details on menu items, advanced usage, and the latest information on the camera.



Scan here

https://rd1.sony.net/help/ilc/2410/h_zz/

ILCE-7SM3 Help Guide



Operating Instructions (this book)



This manual introduces some basic functions.

For the quick start guide, see “Startup guide” (page 6). The “Startup guide” introduces the initial procedures from when you open the package until you release the shutter for the first shot.

In-Camera Guide



The [In-Camera Guide] shows explanations of the menu items on the monitor of the camera.

You can quickly pull up information during shooting.

On the menu screen, select an item for which you want to view a description, and then press the  (Delete) button.

Table of contents

Check out the Help Guide!.....	2
--------------------------------	---



Startup guide

1: Checking the camera and the supplied items.....	6
2: Preparing the battery pack.....	7
3: Inserting a memory card into the camera.....	8
4: Attaching a lens.....	8
5: Performing initial setup for the camera.....	9
6: Shooting still images.....	10

Basic operations

Touch function icons.....	11
Control wheel.....	13
Multi-selector.....	14
Mode dial.....	15
Shooting mode details.....	15
MENU button.....	18
Main menu (shooting setting list).....	21
Fn (Function) button.....	24
C (custom) buttons.....	27
DISP (Display Setting) button.....	28

Using the shooting functions

Focusing.....	31
Selecting the focus method ( Focus Mode).....	31
Selecting the focus area ( Focus Area).....	33
Focusing on human eyes.....	36
Shooting with drive modes (continuous shooting/self-timer).....	39
Cont. Shooting.....	40
Touch functions when shooting.....	41









Using a smartphone and a computer

Functions available with a smartphone (Creators' App).....	42
Managing and editing images on a computer	43

Using the cloud service

Creators' Cloud.....	44
----------------------	----

Finding functions from MENU

List of MENU items.....	45
 (Main) tab.....	45
  (Shooting) tab.....	45
 (Exposure/Color) tab.....	50
 (Focus) tab	53
 (Playback) tab	57
 (Network) tab.....	59
 (Setup) tab	61
 (My Menu) tab.....	66

Identifying parts

Identifying parts.....	68
Front side	68
Rear side	69
Top side.....	71
Sides.....	73
Bottom	76
Basic icons.....	77
During still image shooting.....	77
During movie recording	79

About this product/Notes on use

Notes on using your camera.....	80
Troubleshooting.....	84
Memory cards that can be used.....	85
Specifications.....	87
Index.....	91

1: Checking the camera and the supplied items

The number in parentheses indicates the number of pieces.

- Camera (1)

- Battery charger (1)



- Power cord (mains lead) (1)*
(supplied in some countries/
regions)



* Multiple power cords may be supplied with this equipment. Use the appropriate one that matches your country/region. See page 83.

- Rechargeable battery pack NP-FZ100 (1)



- USB Type-C® cable (1)

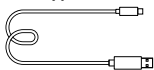

- Shoulder strap (1)

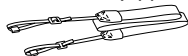

- Body cap (1) (Attached to the camera)



- Cable Protector (1)



- Shoe cap (1) (Attached to the camera)



- Eyepiece cup (1) (Attached to the camera)



- Operating Instructions (1) (this manual)

- Reference Guide (1)

2: Preparing the battery pack

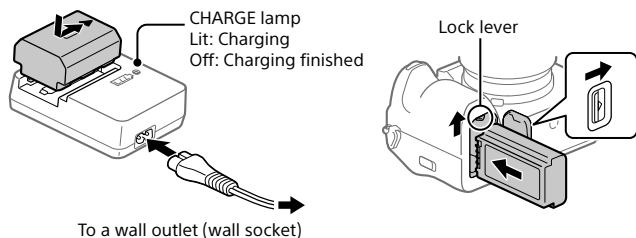

1 Insert the battery pack into the battery charger, and connect it to a wall outlet (wall socket) using the power cord (supplied).

- Place the battery pack on the battery charger in the direction of ▲. Slide the battery pack in the direction of the arrow as far as it will go.

2 Insert the battery pack into the camera.

- Open the battery cover, and then insert the battery pack while pressing the lock lever.

This camera is compatible with USB-PD (USB Power Delivery). When a device compatible with USB-PD is connected to the camera, fast charging is possible. We recommend using a USB-PD device that is compatible with an output of 9 V/3 A or 9 V/2 A.

3: Inserting a memory card into the camera

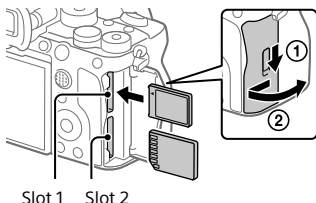

Open the memory card cover and insert the memory card into Slot 1, paying attention to the orientation of the memory card. Then, close the cover.

- Both Slot 1 and Slot 2 of this camera support CFexpress Type A memory cards and SD memory cards. The Slot 1 is used in the default settings. For details on the setting method, refer to the "Help Guide."
- When you use a memory card with this camera for the first time, format the card using the camera in order to stabilize the performance of the memory card.

4: Attaching a lens

1 Mount the lens by aligning the two white index marks (mounting indexes) on the lens and camera.

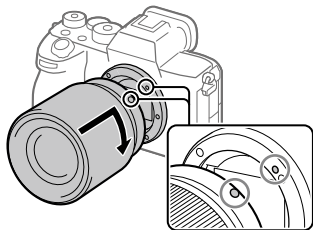

-
- While pushing the lens lightly toward the camera, turn the lens slowly in the direction of the arrow until it clicks into the locked position.
-

5: Performing initial setup for the camera

By establishing a Bluetooth connection (pairing) between the camera and a smartphone, you can perform initial camera setup such as date and time settings from the smartphone. Install the dedicated application on your smartphone in advance, and then follow steps 1 to 3 under "Procedures for initial camera setup."

■ Installing the dedicated smartphone application



Install the application from the following website. Also, update to the latest version of the dedicated application. The specifications of the dedicated application may change without notice.

<https://www.sony.net/ca/>

■ Procedures for initial camera setup

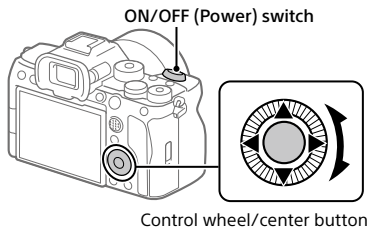

-
- Set the ON/OFF (Power) switch to "ON" to turn on the camera.

2 Select the desired language and then press the center of the control wheel.

3 Follow the instructions on the camera screen to connect the camera with your smartphone and perform the initial setup.

- You can also configure or change the initial settings later from the MENU of the camera.
-

■ Pairing the camera with your smartphone later (Smartphone Connection)



For details on the connection method, refer to the following Help Guide URL:
https://rd1.sony.net/help/ilc/2410_pairing/h_zz/

6: Shooting still images

1 Turn and set the mode dial to **AUTO** (Auto Mode) while pressing the lock release button in the center of the dial.

The shooting mode will be set to **iA** (Intelligent Auto).

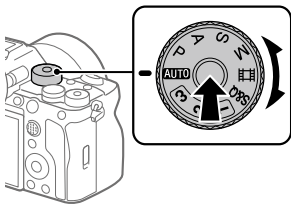

2 Press the shutter button halfway down to focus.

3 Press the shutter button all the way down.

Touch function icons

Some functions have icons for touch operations (touch function icons). You can execute or change the settings of the functions by touching the icons.

■ Settings for using the touch function icons

- [Touch Operation]: [On]
- [Shooting Screen] under [Touch Panel Settings]:
 - Set [Shooting Screen] to [On].
 - [Swipe Right] or [Swipe Left] → desired setting.

■ To show/hide the touch function icons

Swipe right or left on the shooting standby screen. The touch function icons will appear on the left and right sides of the screen according to the settings for [Swipe Right] and [Swipe Left] under [Shooting Screen]. To hide the touch function icons, swipe the screen in the opposite direction from when you made the icons appear.

■ Examples of the touch function icon display and functions of each icon

The examples show the display when you set the icons to appear on both the left and right sides.

During still image shooting

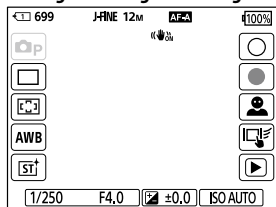

Icons on the left side: Still image shooting mode, [Drive Mode], [Focus Area], [White Balance], [Creative Look]

Icons on the right side: Shoots a still image, starts recording movies, [Face/Eye Subject Select], [Touch Func. in Shooting], switches to the playback screen*

* The shot mark button is displayed even during movie recording in the still image shooting mode so that shot marks can be set for the movie being recorded.

During movie recording

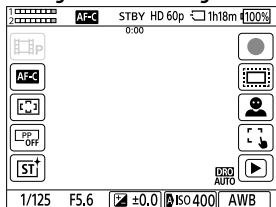

Icons on the left side: Movie recording mode, [Focus Mode], [Focus Area], [Picture Profile], [Creative Look]

Icons on the right side: Starts recording movies, [APS-C/S35 Shooting], [Face/Eye Subject Select], [Touch Func. in Shooting], switches to the playback screen*

* The shot mark button is displayed during movie recording so that shot marks can be set for the movie being recorded.



Hint

- When MENU → [Touch Operation] → [Touch Panel Settings] → [Playback Screen] is set to [On], the touch function icons on the playback screen are always displayed.
- If you set MENU → [Touch Operation] → [Touch Panel Settings] → [Shooting Screen] → [Icon When Monitor Flipped] to [Flip], you can set whether to switch the left and right icons on the shooting screen when the monitor is flipped.

Control wheel

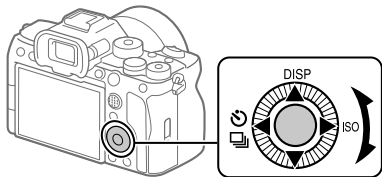
On the menu screen or the screen displayed by pressing the Fn button, you can move the selection frame by turning the control wheel or by pressing the top/bottom/left/right side of the control wheel. Your selection is confirmed when you press the center of the control wheel.



- The DISP (Display Setting), /  (Drive Mode), and ISO ( ISO) functions are assigned to the top/left/right side of the control wheel. In addition, you can assign selected functions to the left/right/bottom side and the center of the control wheel, and to the rotation of the control wheel.
- During playback, you can display the next/previous image by pressing the right/left side of the control wheel or by turning the control wheel.

Multi-selector

You can move the focus area by pushing the multi-selector up/down/left/right. You can also assign a function to be activated when you press the center of the multi-selector.

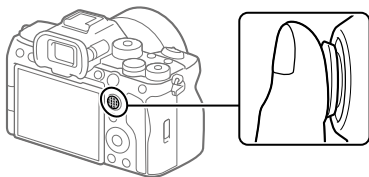

- Put your finger right on top of the multi-selector to manipulate it more precisely.
- You can move the focus area when [Focus Area] is set to the following parameters:
 - [Zone]
 - [Spot: L]/[Spot: M]/[Spot: S]
 - [Expand Spot]
 - [Tracking: Zone]
 - [Tracking: Spot L] / [Tracking: Spot M] / [Tracking: Spot S]
 - [Tracking: Expand Spot]
- The [Focus Standard] function is assigned to the center of the multi-selector in the default settings.

Mode dial

Use the mode dial to select a shooting mode according to the subject and purpose of shooting.

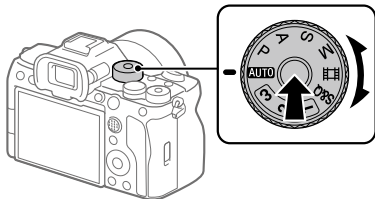

- Turn the mode dial while pressing the mode dial lock release button in the center of the mode dial.

Shooting mode details

The modes on the mode dial are divided into still image shooting modes, movie recording modes, and registration recall modes.

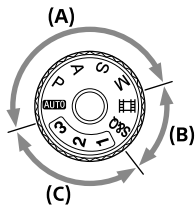

- (A) Still image shooting modes
- (B) Movie recording modes
- (C) Registration recall modes

Hint

- The menu items displayed vary depending on the mode dial setting (pages 20, 45).

(A) Still image shooting modes

The shooting mode you select determines how to adjust the aperture (F value) and shutter speed.

Mode dial	Shooting mode	Description
AUTO (Auto)	Intelligent Auto	The camera shoots with automatic scene recognition.
P	Program Auto	Allows you to shoot with the exposure adjusted automatically (both the shutter speed and the aperture value). You can set shooting functions such as [ISO].
A	Aperture Priority	The aperture value is given priority and the shutter speed is adjusted automatically. Select this when you want to blur the background or focus on the entire screen.
S	Shutter Priority	The shutter speed is given priority and the aperture value is adjusted automatically. Select this when you want to shoot a fast-moving subject without blurring, or when you want to shoot a water or light trail.
M	Manual Exposure	Manually adjust both the aperture value and shutter speed. You can shoot with your favorite exposure.

(B) Movie recording modes

Mode dial	Shooting mode	Description
Movie (Movie)	Movie	You can set the exposure mode for movie shooting.
S&Q	S&Q Motion	You can set the exposure mode for S&Q Motion shooting.

The method for setting the exposure in the movie recording modes depends on the MENU →  (Shooting) → [Shooting Mode] → [Exposure Ctrl Type] setting.

When [Exposure Ctrl Type] is set to [P/A/S/M Mode]:

MENU →  (Shooting) → [Shooting Mode] → [Exposure Mode] or [**S&Q** Exposure Mode] → Select the desired exposure mode from among P/A/S/M.

When [Exposure Ctrl Type] is set to [Flexible Exp. Mode]:

The aperture value, shutter speed, and ISO sensitivity can be switched between the automatic setting and manual setting by using the following functions assigned to custom keys.

- Aperture value
[Auto/Manual Swt. Set.] → [Av Auto/Manual Switch]
- Shutter speed
[Auto/Manual Swt. Set.] → [Tv Auto/Manual Switch]
- ISO sensitivity
[Auto/Manual Swt. Set.] → [ISO Auto/Manual Set]

If you select the manual setting, turn the front/rear dial or the control wheel to set the desired value.

(C) Registration recall modes

Mode dial	Shooting mode	Description
1/2/3	MR Recall Camera Setting	You can call up frequently used modes and numerical value settings that have been registered* in advance then shoot the images. * In [MR Camera Set. Memory], you can register various shooting settings, such as the exposure mode (P / A / S / M), aperture (F value), and shutter speed.

MENU button

The menu screen is displayed by pressing the MENU button. You can change settings related to all of the camera operations including shooting and playback, or you can execute a function from the menu screen.

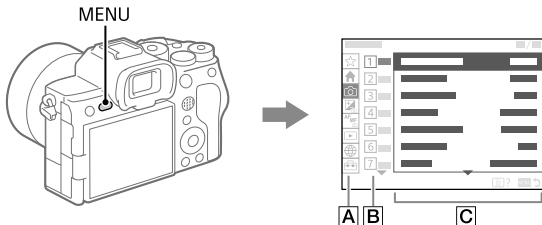

A Menu tab

Menu tabs are categorized by usage scenario, such as shooting, playback, network settings, etc.

B Menu group

In each tab, menu items are grouped by function.

The number assigned to the group is the serial number in the tab. Refer to the number to determine the location of the group in use.

C Menu item

Select the function you want to set or execute.

Hint

- The name of the selected tab or group is displayed at the top of the screen.
- For a list of items displayed on the menu screen, see “List of MENU items” (page 45).
- When [Touch Operation] is set to [On] and [Menu Screen] under [Touch Panel Settings] is set to [On], touch operations on the menu screen are possible.

Basic operations on the menu screen

- ① Press the **MENU** button to display the menu screen.
- ② Move within the menu tree and find the desired menu item by pressing the top/bottom/left/right side of the control wheel.
 - The displayed menu items differ between the still image shooting modes and movie recording modes (page 20).



- ③ Press the center of the control wheel to select the menu item.

The setting screen or execution screen for the selected item will appear on the monitor.

- ④ Select a parameter or execute the function.
 - If you want to cancel changing the parameter, press the **MENU** button and go back to the previous screen.
- ⑤ Press the **MENU** button to exit the menu screen.
 - You will return to the shooting screen or playback screen.

Hint

- In the (Main) tab, you can view a list of the current shooting settings. Select a setting value in the tab to open the corresponding menu item and change the setting value.
- You can display the menu screen by assigning the [MENU] function to a custom key using [Custom Key/Dial Set.] or [Custom Key/Dial Set.], and then pressing that key.

Relationship between the mode dial and menu screen

The menu groups and menu items displayed in the [Main], [Shooting], [Exposure/Color], and [Focus] tabs vary depending on the mode dial setting.

Still image shooting modes (AUTO/P/A/S/M)

- Menu items for shooting still images are displayed.*

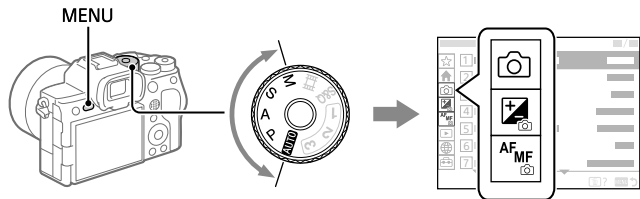





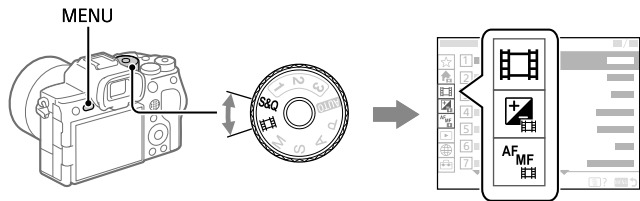

- * Since you can record movies with the MOVIE (Movie) button even in the still image shooting mode, some basic movie menu items are also displayed.

Movie recording modes (Movie/S&Q)

- Menu items for recording movies are displayed.



Icons used in this manual

-   : Menu items displayed in the still image shooting modes (AUTO/P/A/S/M)
-   : Menu items displayed in the movie recording modes (Movie/S&Q)
-   : Menu items displayed in both the still image shooting modes and movie recording modes





Main menu (shooting setting list)

Select the  (Main) tab on the menu screen to display a list of shooting settings. You can confirm the settings before shooting or for each scene, and also change the settings directly from this screen.

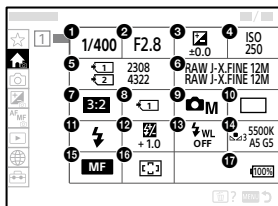
Main menu for shooting still images

Main 1



- 1 Shutter Speed*
- 2 Aperture*
- 3  Exposure Comp.
- 4  ISO
- 5 Format
- 6 Image Quality Settings
- 7 Aspect Ratio
- 8  Rec. Media Settings
- 9 Shoot Mode
- 10 Drive Mode
- 11 Flash Mode
- 12 Flash Comp.
- 13 Wireless Flash
- 14  White Balance
- 15  Focus Mode

16  Focus Area

17 Remaining battery level

* When the shooting mode is [Program Auto], the shutter speed and aperture value are displayed in the same area. You can perform Program Shift by selecting the area.

Main menu for shooting movies

Main 1

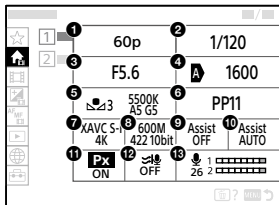

1 Rec Frame Rate/**S&Q** Rec Frame Rate (when shooting slow-motion/quick-motion movies)

2 Shutter Speed

3 Aperture

4  ISO

5  White Balance

6  Picture Profile

7  File Format

8 Record Setting/**S&Q** S&Q Settings (when shooting slow-motion/quick-motion movies)

9 Gamma Display Assist

10 Gamma Disp. Assist Typ.

11 **Px** Proxy Recording

12 Wind Noise Reduct.

13 Audio Rec Level

Main 2

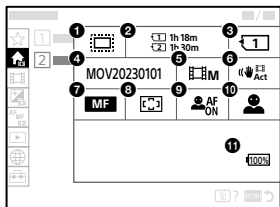

- 1 APS-C/S35 Shooting
- 2 Format
- 3 Recording Media
- 4 File Settings
- 5 Shoot Mode
- 6 SteadyShot
- 7 Focus Mode
- 8 Focus Area
- 9 Face/Eye Prior. in AF
- 10 Face/Eye Subject
- 11 Remaining battery level

Hint

- If you assign the [Display Main Menu] function to the desired key using the custom key settings, you can also open the Main menu by pressing the assigned key.
- You can open the setting screens by touching the icons on the main menu when [Touch Operation] is set to [On] and [Menu Screen] under [Touch Panel Settings] is set to [On].

Fn (Function) button

If you press the Fn (function) button while shooting or playing back images, a menu (function menu) containing frequently used functions will appear on the screen, allowing you to quickly call up the functions.

Example of function menu

The displayed items differ depending on the camera status.

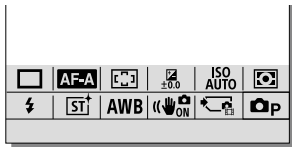

Hint

- Use [Fn Menu Settings]/[Fn Menu Settings] to register your favorite functions to the function menus for shooting still images, for shooting movies, and for playing back images, respectively. You can register 12 functions to each function menu.
- When [Touch Operation] is set to [On] and [Shooting Screen]/[Playback Screen] under [Touch Panel Settings] is set to [On], touch operations on the function menu screen are possible.
- When [Touch Operation] is set to [On] and [Shooting Screen]/[Playback Screen] under [Touch Panel Settings] is set to [On], you can also open [Fn Menu Settings]/[Fn Menu Settings] by holding down the icon in the function menu.
- When [Swipe Up] under [Shooting Screen] is set to [Open the Fn Menu], the function menu can be displayed using touch operations by swiping the shooting screen upward quickly. When [Playback Screen] is set to [On], the function menu can be displayed using touch operations by swiping the playback screen upward quickly.
- Swipe downward from the area outside of the function menu or touch the area outside of the function menu to close the function menu.

1 Press the Fn (Function) button.

- On the shooting screen, press DISP on the control wheel repeatedly to display a screen mode other than [For viewfinder], and then press the Fn button.



Fn (Function) button

2 Press the top/bottom/left/right side of the control wheel to select a function to set.

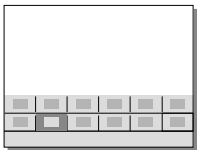

3 On the shooting screen, turn the front dial to select the desired setting.

- Some functions can be fine-tuned using the rear dial.

4 Press the center of the control wheel.

Using the Fn button in the [For viewfinder] display

If you press the Fn button while the monitor display is set to [For viewfinder], you can directly operate items you want to change.

In the auto mode



In the P/A/S/M mode

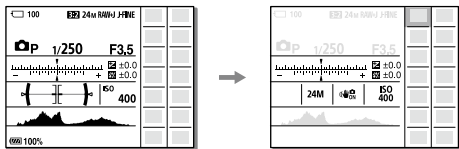

- The displayed contents and their positions shown in the illustrations are just a guideline, and may differ from the actual display.

To adjust settings from the dedicated setting screens

Select the icon for the desired function and then press the center of the control wheel. The dedicated setting screen for the function will appear. Follow the operating guide to adjust settings.

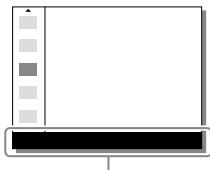

Operating guide

Note

- Items that are grayed out on the [For viewfinder] screen cannot be changed by pressing the Fn button.
- Some settings, such as [Creative Look] and [Picture Profile], cannot be operated on the [For viewfinder] screen unless you enter the dedicated setting screen.

C (custom) buttons



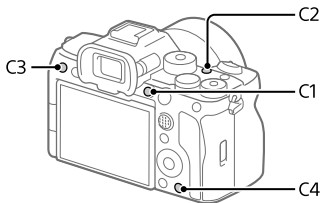

If you assign frequently used functions to the custom buttons (C1 to C4) in advance, you can quickly call up those functions simply by pressing the button during shooting or playback.

Recommended functions are assigned to the custom buttons by default.



I To check/change the functions of the custom buttons

You can confirm the function currently assigned to each custom button via the following procedure.

MENU →  (Setup) → [Operation Customize] →
[ Custom Key/Dial Set.], [ Custom Key/Dial Set.] or
[ Custom Key Setting].

If you want to change the function of the custom button, press the center of the control wheel while the custom button is selected. The functions that can be assigned to that button will appear. Select your desired function.

DISP (Display Setting) button

By pressing the DISP (Display Setting) button, you can change the content displayed on the screen during shooting and playback. The display switches each time the DISP button is pressed. The viewfinder display and the monitor display for shooting can be set separately.

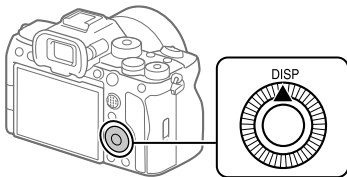

Hint

- The monitor can be turned off with the DISP button. Add a check mark to [Monitor Off] under MENU → [Setup] → [Operation Customize] → [DISP (Screen Disp) Set] → [Monitor].

During shooting (Monitor)

Display All Info. → No Disp. Info. → Histogram → Level →

For viewfinder → Display All Info.

When shooting still images:

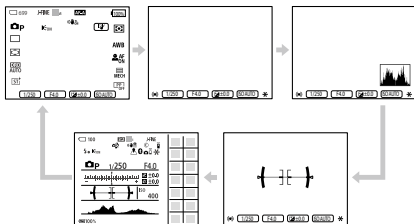

When shooting movies:

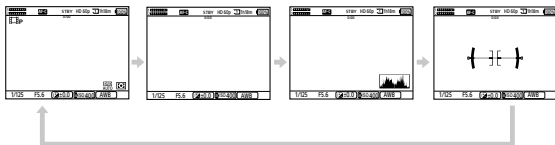

During shooting (Viewfinder)

Level → No Disp. Info. → Histogram → Level

When shooting still images:

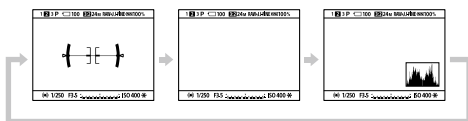

When shooting movies:

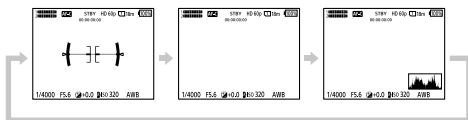

- To switch the information displayed on the viewfinder, press the DISP button while looking into the viewfinder.

During playback (Monitor/Viewfinder)

Display Info. → Histogram → No Disp. Info. → Display Info.

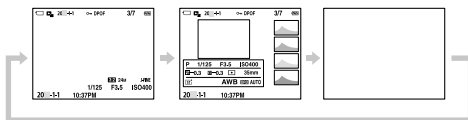

- If the image has an overexposed or underexposed area, the corresponding section will blink on the histogram display (overexposed/underexposed warning).
- The settings for playback are also applied in [📷 Auto Review].

Note

- The displayed contents and their position shown in the illustration are just a guideline, and may differ from the actual display.
- The following are not displayed in the default settings.
 - Monitor Off
 - Display All Info. (when using the viewfinder)
- In the movie recording modes, [📷 For viewfinder] cannot be displayed. If the monitor display is set to [📷 For viewfinder], the display will switch to all information when movie shooting starts.

Focusing

Selecting the focus method (Focus Mode)



Selects the focus method to suit the movement of the subject.

MENU → **AF_{MF} (Focus)** → **[AF/MF]** → **[Focus Mode]** → **desired setting.**

AF-S (Single-shot AF): The product locks the focus once focusing is complete. Use this when the subject is motionless.

AF-A (Automatic AF): [Single-shot AF] and [Continuous AF] are switched according to the movement of the subject. When the shutter button is pressed halfway down, the product locks the focus when it determines that the subject is motionless, or continues to focus when the subject is in motion. During continuous shooting, the product automatically shoots with [Continuous AF] from the second shot.

AF-C (Continuous AF): The product continues to focus while the shutter button is pressed and held halfway down. Use this when the subject is in motion. In [Continuous AF] mode, there is no beep when the camera focuses.

DMF (Direct manual focus): You can make fine adjustments manually after performing auto focusing, letting you focus on a subject more quickly than when using [Manual Focus] from the beginning. This is convenient in situations such as macro shooting.

MF (Manual Focus): Adjusts the focus manually. If you cannot focus on the intended subject using auto focus, use [Manual Focus].

Focus indicator

- **(lit)**: The subject is in focus and the focus is locked.
- **(flashing)**: The subject is not in focus.
- ⦿ **(lit)**: The subject is in focus. The focus will be adjusted continuously according to the movements of the subject.
- ⦿ **(lit)**: Focusing is in progress.

Subjects on which it is difficult to focus using auto focus

- Dark and distant subjects
- Subjects with poor contrast
- Subjects seen through glass
- Fast-moving subjects
- Reflective light or shiny surfaces
- Flashing light
- Back-lit subjects
- Continuously repetitive patterns, such as the facades of buildings
- Subjects in the focusing area with different focal distances

Hint

- In [Continuous AF] mode, you can lock the focus by pressing and holding the button that has been assigned the [Focus Hold] function.
- When you set the focus to infinity in the [Manual Focus] mode or the [DMF] mode, make sure that the focus is on a sufficiently distant subject by checking the monitor or the viewfinder.

Note







- [Automatic AF] is available only when you are using a lens that supports phase detection AF (page 36).
- When [Continuous AF] or [Automatic AF] is set, the angle of view may change little by little while focusing. This does not affect the actual recorded images.
- Only [Continuous AF] and [Manual Focus] are available when shooting movies or when the mode dial is set to **S&Q** (S&Q Motion).

Selecting the focus area (Focus Area)



Set the type of focusing frame when shooting with the auto focus. Select the mode according to the subject.

MENU → ^{AF}_{MF} (**Focus**) → [**Focus Area**] → [**Focus Area**] → **desired setting**.

-  **Wide:** Focuses on a subject covering the whole range of the screen automatically. When you press the shutter button halfway down in the still image shooting mode, a green frame is displayed around the area that is in focus.
-  **Zone:** Select a zone on the monitor on which to focus, and the product will automatically select a focus area.
-  **Center Fix:** Focuses automatically on a subject in the center of the image. Use together with the focus-lock function to create the composition you want.
-  **Spot: L / Spot: M / Spot: S:** Allows you to move the focusing frame to a desired point on the screen and focus on an extremely small subject in a narrow area.
-  **Expand Spot:** If the product cannot focus on a single selected point, it uses focus points around the [Spot] as a secondary priority area for focusing.
-  **Tracking:** This setting is available only when the [**Focus Mode**] is set to [Continuous AF]. When the shutter button is pressed and held halfway down, the product tracks the subject within the selected autofocus area. Point the cursor at [Tracking] on the [**Focus Area**] setting screen, and then select the desired area to start tracking using the left/right sides of the control wheel. You can also move the tracking start area to the desired point by designating the area as a [Tracking: Zone], [Tracking: Spot L]/[Tracking: Spot M]/[Tracking: Spot S] or [Tracking: Expand Spot].

Note

- [Focus Area] is locked to [Wide] in the following situations:
 - [Intelligent Auto]
- The focus area may not light up during continuous shooting or when the shutter button is pressed all the way down at once.
- When the mode dial is set to **M** (Movie) or **S&Q** (S&Q Motion), or during movie shooting, [Tracking] cannot be selected as the [Focus Area].

Examples of the focusing frame display

The focusing frame differs as follows.

When focusing on a larger area

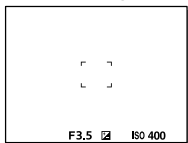

When focusing on a smaller area

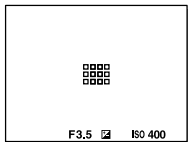

- When [Focus Area] is set to [Wide] or [Zone], the focusing frame may switch between “When focusing on a larger area” and “When focusing on a smaller area” depending on the subject or situation.
- When you attach an A-mount lens with a Mount Adaptor (LA-EA3 or LA-EA5) (sold separately), the focusing frame for “When focusing on a smaller area” may be displayed.

When focus is achieved automatically based on the whole range of the monitor

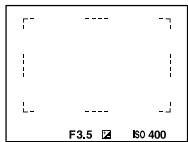

- When you use a zoom function other than the optical zoom in the still image shooting mode, the [Focus Area] setting is disabled and the focusing frame is shown by the dotted line. The AF operates with priority on and around the center area.

To move the focus area

You can move the focus area by operating the multi-selector when [Focus Area] is set to the following parameters:

- [Zone]
- [Spot: L] / [Spot: M] / [Spot: S]
- [Expand Spot]
- [Tracking: Zone]
- [Tracking: Spot L] / [Tracking: Spot M] / [Tracking: Spot S]
- [Tracking: Expand Spot]

If you assign [Focus Standard] to the center of the multi-selector beforehand, you can move the focusing frame back to the center of the monitor by pressing the center of the multi-selector.

Hint

- When [Focus Area] is set to [Spot] or [Expand Spot], you can move the focusing frame over a greater distance at a time by setting [AF Frame Move Amt] to [Large].
- You can move the focusing frame quickly by touching and dragging it on the monitor. Set [Touch Operation] to [On], and set [Touch Func. in Shooting] under [Shooting Screen] in [Touch Panel Settings] to [Touch Focus] beforehand.

To track the subject temporarily when shooting still images (Tracking On)

You can temporarily change the setting for [Focus Area] to [Tracking] while you press and hold down the custom key to which you have assigned [Tracking On] in advance. The [Focus Area] setting before you activated [Tracking On] will switch to the equivalent [Tracking] setting. For example:

[Focus Area] before you activate [Tracking On]	[Focus Area] while [Tracking On] is active
[Wide]	[Tracking: Wide]
[Spot: S]	[Tracking: Spot S]
[Expand Spot]	[Tracking: Expand Spot]

Phase detection AF

When there are phase detection AF points within the auto focus area, the product uses the combined autofocus of the phase detection AF and contrast AF.











Note

- Phase detection AF is available only when a compatible lens is attached. If you use a lens that does not support phase detection AF, you cannot use [Automatic AF], [AF Tracking Sensitivity], [AF Subj. Shift Sensitivity] or [AF Transition Speed]. Also, even if you use a previously purchased applicable lens, the phase detection AF might not function unless you update the lens.

Focusing on human eyes

The camera can automatically detect faces and eyes and focus on the eyes (Eye AF). The following explanation is for cases where the detection target is human. The faces of up to 8 subjects can be detected.





There are two methods for performing [Eye AF], with some differences between their specifications. Select the appropriate method according to your purpose.

Item	 Face/Eye Prior. in AF] function	[Eye AF] via a custom key
Characteristics	The camera will detect faces/eyes with greater priority.	The camera will detect faces/eyes exclusively.
Advance preparation	<ul style="list-style-type: none"> Select  Face/Eye Prior. in AF] → [On] (page 55). Select  Face/Eye Subject] → [Human]. 	Assign [Eye AF] to the desired key using  Custom Key/Dial Set.] or  Custom Key/Dial Set.].
How to perform [Eye AF]	Press the shutter button halfway down.	Press the key to which you have assigned the [Eye AF] function*.
Function details	<ul style="list-style-type: none"> When the camera detects a face or eye inside or around the designated focus area, it focuses on the face or eye with greater priority. If the camera does not detect any faces or eyes inside or around the designated focus area, it will focus on another detectable subject. 	<ul style="list-style-type: none"> The camera focuses exclusively on faces or eyes anywhere on the screen, regardless of the setting for  Focus Area]. The camera will not automatically focus on another subject if no face or eye is detected anywhere on the screen.
Focus mode	Follows the setting designated with  Focus Mode]	Follows the setting designated with  Focus Mode]
Focus area	Follows the setting designated with  Focus Area].	The focus area temporarily becomes the entire screen, regardless of the setting for  Focus Area].

* Regardless of whether  Face/Eye Prior. in AF] is set to [On] or [Off], you can use [Eye AF] via a custom key while you are pressing the custom key to which you have assigned [Eye AF].

[Eye AF] by custom key

The Eye AF function can be used by assigning [Eye AF] to a custom key. The camera can focus on eyes as long as you are pressing the key. This is useful when you want to temporarily apply the Eye AF function to the entire screen regardless of the setting for  Focus Area]. The camera does not focus automatically if no faces or eyes are detected.

- ① **MENU** →  (**Setup**) → [**Operation Customize**] → [ **Custom Key/Dial Set.**] or [ **Custom Key/Dial Set.**] → desired key, then assign the [**Eye AF**] function to the key.
- ② **MENU** → ^{AF}_{MF} (**Focus**) → [**Face/Eye AF**] → [ **Face/Eye Subject**] → [**Human**].
- ③ **Point the camera at the face of a human, and press the key to which you have assigned the [Eye AF] function.**
To shoot a still image, press the shutter button while pressing the key.

■ To focus on the eyes of an animal

Set [ **Face/Eye Subject**] to [**Animal**] before shooting.

If the detection target is an animal, eyes can be detected only when shooting still images. Faces of animals are not detected.

Note

- The [**Eye AF**] function may not function very well in the following situations:
 - When the person is wearing sunglasses.
 - When the front hair covers the person's eyes.
 - In low-light or back-lit conditions.
 - When the eyes are closed.
 - When the subject is in the shade.
 - When the subject is out of focus.
 - When the subject is moving too much.There are also other situations in which it may not be possible to focus on the eyes.
- When the camera cannot focus on human eyes, it will detect and focus on the face instead. The camera cannot focus on eyes when no human faces are detected.
- The camera may not detect faces at all or may accidentally detect other objects as faces in some conditions.

Shooting with drive modes (continuous shooting/self-timer)





Select the appropriate mode for the subject, such as single shooting, continuous shooting or bracketing shooting.

1 Select (Drive Mode) on the control wheel → desired setting.

- You can also set the drive mode by selecting MENU →  (Shooting) → [Drive Mode] → [Drive Mode].
- For details on parameters other than [Cont. Shooting], refer to the “Help Guide.”

 **Single Shooting:** Shoots one image when you press the shutter button.

 **Cont. Shooting:** Shoots images continuously while you press and hold down the shutter button (page 40).

 **Self-timer(Single):** Shoots an image after a designated number of seconds have elapsed since the shutter button was pressed.

 **Self-timer(Cont):** Shoots a designated number of images after a designated number of seconds have elapsed since the shutter button was pressed.

BRK C Cont. Bracket: Shoots images while holding the shutter button down, each with different degrees of exposure.

BRK S Single Bracket: Shoots a specified number of images, one by one, each with a different degrees of exposure.

BRK WB WB bracket: Shoots a total of three images, each with different color tones according to the selected settings for white balance, color temperature and color filter.

BRK DRO DRO Bracket: Shoots a total of three images, each at a different degree of D-Range Optimizer.

2 Select the desired mode using the right/left side of the control wheel.

Cont. Shooting



Shoots images continuously while you press and hold down the shutter button.

1 Select (Drive Mode) on the control wheel → [Cont. Shooting].

- You can also set the drive mode by selecting MENU → (Shooting) → [Drive Mode] → [Drive Mode].

2 Select the desired mode using the right/left side of the control wheel.

Continuous Shooting: Hi+: Images are shot continuously at the maximum speed while you press and hold down the shutter button.

Continuous Shooting: Hi / **Continuous Shooting: Mid** / **Continuous Shooting: Lo**: Subjects are easier to track because the subject is displayed in real-time on the monitor or viewfinder during shooting.

Hint

- To continuously adjust the focus and exposure during continuous shooting, set as follows:
 - [Focus Mode]: [Continuous AF]
 - [AEL w/ Shutter]: [Off] or [Auto]

Note

- When the F-value is greater than F11 in [Continuous Shooting: Hi+], [Continuous Shooting: Hi] or [Continuous Shooting: Mid] mode, the focus is locked to the setting in the first shot.
- The subject is not displayed in real-time on the monitor or viewfinder when shooting in [Continuous Shooting: Hi+] mode.
- The speed of continuous shooting decreases when shooting in uncompressed RAW.
- The speed of continuous shooting decreases when you shoot with a flash.

Touch functions when shooting

You can use two different touch functions when focusing with this camera.

Touch Focus

You can specify where to focus using touch operations.

Touch Tracking

The camera maintains focus on the subject that was touched on the monitor. The camera continues tracking even if the subject moves.

Touch Shutter

The camera automatically focuses on the point you touch and shoots a still image.

Touch pad operations

There are two kinds of touch operations for this camera. One is touch panel operations: touching the monitor while looking directly at it. The other is touch pad operations: using the monitor as a touch pad while looking through the viewfinder.

Select MENU →  (Setup) → [Touch Operation] → [Touch Panel/Pad] to choose which type of operation to enable.

For details on the touch functions, refer to the “Help Guide.”

Hint

- Setting [Touch Sensitivity] to [Sensitive] improves the touch response.

Note

- The monitor may not respond when you operate it with gloves.

Functions available with a smartphone (Creators' App)

Using the smartphone application Creators' App, you can shoot an image while controlling the camera using a smartphone or transfer the images recorded on the camera to the smartphone.

Download and install the application Creators' App from your smartphone's application store. If Creators' App is already installed on your smartphone, be sure to update it to the latest version.



For details on Creators' App, refer to the following website.

<https://www.sony.net/ca/>

Hint

- You can also install Creators' App by scanning the QR Code displayed on the screen of the camera using your smartphone.

Note

- Depending on future version upgrades, the operational procedures or screen displays are subject to change without notice.

Supported smartphones

Refer to the support page for the latest information.

<https://www.sony.net/ca/help/mobile/>

- For details on Bluetooth versions compatible with your smartphone, check the product website for your smartphone.

Managing and editing images on a computer

By connecting the camera to a computer using a USB cable or inserting the camera's memory card into the computer, you can import recorded images to the computer.

You can perform remote shooting from a computer, and adjust or develop RAW images recorded with the camera by using the software suite Imaging Edge Desktop.

For details on the computer software, refer to the following URL:
<https://www.sony.net/disoft/>

Creators' Cloud

Creators' Cloud is a cloud solution that integrates production applications and services.

Creators' Cloud provides services and applications to creators of various productions.

The availability of Creators' Cloud and the supported services differ depending on the country/region.



For details on Creators' Cloud and the support status of each service, refer to the following website.

<https://www.sony.net/cc/>

Finding functions from MENU



List of MENU items



For details on how to use the menu, see “MENU button” (page 18).

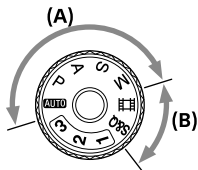

The displayed menu items vary depending on the position of the mode dial (page 15).

In the tables below, the modes in which each menu item is displayed are indicated by the still image/movie icons.



  : The menu item is displayed when the mode dial position is set to the still image shooting modes **(A)**.

  : The menu item is displayed when the mode dial position is set to the movie recording modes **(B)**.







  : The menu item is displayed when the mode dial position is set to either the still image shooting modes **(A)** or the movie recording modes **(B)**.















- When the mode dial is set to 1, 2, or 3 (MR Recall Camera Setting), the displayed menu items are determined by the mode registered to each registration number.





























↑ (Main) tab

















Shooting settings are displayed in a list. For details, refer to “Main menu (shooting setting list)” (page 21).













































(Shooting) tab

Image Quality/Rec		
 	JPEG/HEIF Switch	Switches the file format for still images to either JPEG or HEIF.
 	Image Quality Settings	Configures settings for still images, such as image quality and image size.
 	Aspect Ratio	Selects the aspect ratio for still images.

	File Format	Selects the movie file format. ([XAVC HS 4K] / [XAVC S 4K], etc.)
	Movie Settings	Selects a frame-rate and bit-rate for the movie.
	S&Q S&Q Settings	Changes the settings for slow-motion and quick-motion movie shooting.
	Px Proxy Settings	Records low-bit-rate proxy files simultaneously.
	APS-C/S35 Shooting	Sets whether or not to record with the angle of view of the APS-C size for still images and Super35mm size for movies.
	Long Exposure NR	Sets noise reduction processing for shots with a shutter speed of 1 second or longer.
	High ISO NR	Sets noise reduction processing for high-sensitivity shooting.
	HLG Still Image	Shoots still images compatible with the HDR standard Hybrid Log-Gamma (HLG).
	Color Space	Changes the color space (range of reproducible colors).
	Lens Compensation	Selects the type of lens compensation.
Media		
	Format	Formats the memory card.
	Rec. Media Settings	Sets the method for recording images to two memory card slots.
	Recover Image DB	Recovers the image database file and enables recording and playback.
	Display Media Info.	Displays the remaining recording time of movies and the recordable number of still images on the memory card.
File		
	File/Folder Settings	Sets file names for still images to be shot, and specifies folders for storing the shot still images.

 	Select REC Folder	Selects the folder to which images are saved (REC folder) when [Folder Name] under [File/Folder Settings] is set to [Standard Form], and there are two or more folders.
 	Create New Folder	Creates a new folder on the memory card for recording still images.
 	IPTC Information	Writes IPTC information when recording still images.
 	Copyright Info	Sets copyright information for still images.
 	 Write Serial Number	Writes the camera's serial number when shooting.
 	File Settings	Sets file numbers and file names for movies to be recorded.
Shooting Mode		
 	Exposure Mode	Sets the exposure mode when shooting movies.
 	S&Q Exposure Mode	Sets the exposure mode when shooting slow-motion/quick-motion movies.
 	Exposure Ctrl Type	Selects the method for setting the exposure during movie shooting.
 	MR Recall Camera Setting	Calls up settings pre-registered to [MR Camera Set. Memory].
 	MR Camera Set. Memory	Registers the desired modes and camera settings.
 	MR Memory/Recall Media	Selects the memory card slot from which settings are recalled or to which settings are registered for M1 through M4.
 	Reg. Custom Shoot Set	Assign functions to the custom key to recall when shooting.
Drive Mode		
 	Drive Mode	Selects a shooting mode, such as continuous shooting. ([Self-timer(Single)] / [Cont. Bracket], etc.)



















	Bracket Settings	Sets self-timer shooting in the bracket mode, and the shooting order for exposure bracketing or white-balance bracketing.
	Interval Shoot Func.	Configures settings for interval shooting.
Shutter/Silent		
	 Silent Mode Settings	Sets the silent mode to suppress the operating sounds of the camera.
	Shutter Type	Sets whether to shoot with a mechanical shutter or an electronic shutter.
	e-Front Curtain Shut.	Sets whether to use the electronic front curtain shutter function.
	 Release w/o Lens	Sets whether to release the shutter when the lens is not attached.
	Release w/o Card	Sets whether to release the shutter when a memory card is not inserted.
	Anti-flicker Shoot.	Detects flickering/blinking from artificial light sources such as fluorescent lighting and times the shooting of images to moments when flickering will have less of an impact.
Audio Recording		
	Audio Recording	Sets whether to record audio when shooting a movie.
	Audio Rec Level	Adjusts the audio recording level during movie recording.
	Audio Out Timing	Sets echo cancellation during audio monitoring and prevent undesirable deviations between video and audio.
	Wind Noise Reduct.	Reduces wind noise during movie recording.
	 niShoe Audio Set.	Sets the recording format for digital audio transmitted from accessories attached to the Multi interface shoe.
TC/UB		
	Time Code Preset	Sets the time code.

















 	User Bit Preset	Sets the user bit.
 	Time Code Format	Sets the recording method for the time code. (Only when [NTSC/PAL Selector] is set to NTSC.)
 	Time Code Run	Sets the count up format for the time code.
 	Time Code Make	Sets the recording format for the time code on the recording medium.
 	User Bit Time Rec	Sets whether or not to record the time as a user bit.
Image Stabilization		
 	 SteadyShot	Sets whether to activate SteadyShot during still-image shooting.
 	 SteadyShot	Sets whether to activate SteadyShot during movie recording.
 	 SteadyShot Adjust.	Sets SteadyShot settings.
 	  Focal Length	Applies the SteadyShot function according to the focal length set using [  Focal Length] when [ SteadyShot Adjust.] is set to [Manual].
Zoom		
 	 Zoom	Sets the zoom scale.
 	 Zoom Range	Sets whether to use the Clear Image Zoom and Digital Zoom when zooming.
 	 Custom Key Z. Speed	Sets the zoom speed when the zoom function is assigned to a custom key.
 	 Remote Zoom Speed	Sets the zoom speed when using the zoom function with a remote control.
Shooting Display		
 	 Grid Line Display	Sets whether or not to display grid lines for adjusting the image composition.
 	 Grid Line Type	Selects a grid line type from among [Rule of 3rds Grid], [Square Grid], and [Diag. + Square Grid].

















	Live View Display Set.	Sets whether to apply settings such as exposure compensation to the live view display.
	Emphasized REC Display	Sets whether or not to display a red frame around the edges of the camera's monitor while recording a movie.
Marker Display		
	Aspect Marker	Sets whether or not to display the aspect marker when shooting still images.
	Aspect Marker Type	Sets the aspect ratio of the displayed aspect marker.
	Aspect Marker Level	Sets the color density for the displayed aspect marker.
	Marker Display	Sets whether to display markers on the monitor when recording movies.
	Center Marker	Sets whether or not to display the center marker in the center of the shooting screen.
	Aspect Marker	Sets the aspect marker display when recording a movie.
	Safety Zone	Sets the safety zone display. This becomes the standard range that can be received by a general household TV.
	Guideframe	Sets whether or not to display the guide frame. You can verify whether the subject is level or perpendicular to the ground.

(Exposure/Color) tab



Exposure		
	Auto Slow Shutter	Sets whether or not to automatically slow down the shutter speed when recording movies if the subject is dark.
	ISO	Sets the ISO sensitivity.











	 ISO Range Limit	You can limit the range of ISO sensitivity when the ISO sensitivity is set manually.
	ISO AUTO Min. SS	If you select [ISO AUTO] when the shooting mode is [Program Auto] or [Aperture Priority], you can set the shutter speed at which the ISO sensitivity starts changing.
	Auto/Manual Swt. Set.	When recording movies, you can switch the auto/manual setting of the aperture value, shutter speed, and the ISO sensitivity independently. You can use this function just like the exposure control system of a professional video camera. The function is available when [Exposure Ctrl Type] is set to [Flexible Exp. Mode].
Exposure Comp.		
	 Exposure Comp.	Compensates for the brightness of the entire image.
	 Reset EV Comp.	Sets whether to maintain the exposure value set using [ Exposure Comp.] when you turn off the power when the exposure compensation dial position is set to "0."
	 Exposure step	Selects the size of the increment step for shutter speed, aperture, and exposure compensation values.
	 Exposure Std. Adjust	Adjusts the standard for the correct exposure value for each metering modes.
Metering		
	 Metering Mode	Selects the method for measuring brightness. ([Multi] / [Spot], etc.)
	 FacePriorityinMultiMetering	Sets whether the camera measures brightness based on detected faces when [ Metering Mode] is set to [Multi].





















	 Spot Metering Point	Sets whether to coordinate the spot metering point with the focus area when [ Focus Area] is set to [Spot], etc.
	AEL w/ Shutter	Sets whether to lock the exposure when the shutter button is pressed halfway down. This is useful when you want to adjust the focus and exposure separately.
Flash		
	Flash Mode	Sets the flash settings.
	Flash Comp.	Adjusts the intensity of flash output.
	Exp.comp.set	Sets whether to reflect exposure compensation value to flash compensation.
	Wireless Flash	Sets whether to shoot with the wireless flash.
	Red Eye Reduction	Reduces the red-eye phenomenon when using flash.
	External Flash Set.	Sets the flash mode or luminescence of the external flash from menu on the camera.
	Reg. Flash Shooting Set	The shutter speed and ISO sensitivity when shooting with the flash are kept separately from the settings when the flash is not used. The camera determines whether or not the flash is turned on and automatically switches between settings.
White Balance		
	 White Balance	Corrects the tone effect of the ambient light to shoot whitish objects in a white tone. ([Auto] / [Daylight], etc.)
	 Priority Set in AWB	Selects which tone to prioritize when shooting under lighting conditions such as incandescent light with [ White Balance] set to [Auto].























	Shutter AWB Lock	Sets whether to lock the white balance while the shutter button is pressed in the auto white balance mode.
	Shockless WB	Sets the switching speed of White Balance during movie shooting, such as when the setting value for  White Balance] or  Priority Set in AWB] is changed.
	 WB Capt. Frame Size	Changes the size of the white-balance capture frame used when setting the custom white balance.
Color/Tone		
	 D-Range Optimizer	Analyzes the contrast of light and shadow between the subject and the background by dividing the image into small areas, and creates an image with the optimal brightness and gradation.
	 Creative Look	Selects the desired image processing ([VV] / [PT], etc.). You can also make detailed adjustments to parameters such as contrast, saturation, and sharpness.
	 Picture Profile	Changes settings such as color and tone when recording images. * This function is for skilled movie creators.
Zebra Display		
	 Zebra Display	Sets whether or not to display stripes to use as a guide when adjusting the brightness.
	 Zebra Level	Adjusts the brightness level of the zebra pattern.

AF_{MF} (Focus) tab















AF/MF		
	 Focus Mode	Selects the focus mode. ([Single-shot AF] / [Continuous AF], etc.)





















	Priority Set in AF-S	Sets the timing of the shutter release when [AF-ON] Focus Mode] is set to [Single-shot AF], [DMF], or [Automatic AF] with a still subject.
	Priority Set in AF-C	Sets the timing of the shutter release when [AF-ON] Focus Mode] is set to [Continuous AF] with a moving subject.
	AF Tracking Sensitivity	Sets the AF tracking sensitivity for the still image shooting mode.
	AF Illuminator	Sets the AF illuminator, which provides light to aid focusing in dark scenes.
	Aperture Drive in AF	Changes the aperture drive system to prioritize the auto-focusing tracking performance or to prioritize silence.
	Preset Focus/Zoom	Registers a combination of focus position (distance to the subject in focus) and zoom position (angle of view) to the custom key and sets the focus position/zoom position to be recalled by pressing the custom key.
	AF w/ Shutter	Sets whether to perform auto focusing when the shutter button is pressed halfway down. This is useful when you want to adjust the focus and exposure separately.
	Pre-AF	Sets whether or not to perform auto focus before the shutter button is half pressed.
	AF Transition Speed	Sets the speed at which the focus position is moved when the target of the auto focus is switched during movie shooting.
	AF Subj. Shift Sensitivity	Sets the sensitivity with which the focus switches to another subject when the original subject leaves the focus area during movie shooting.
	AF Assist	Changes the subject in focus by operating the focus ring of the lens while shooting a movie with auto focus.

Focus Area		
 	Focus Area	Selects the area of focus. ([Wide] / [Spot], etc.)
 	Focus Area Limit	Limits the types of available focus area settings in advance.
	Switch V/H AF Area	Sets whether to adjust the  [Focus Area] and the position of the focusing frame based on the camera's position (horizontal or vertical).
 	Focus Area Color	Sets the color of the frame indicating the focusing area.
	AF Area Registration	Sets whether to temporarily move the focusing frame to a preassigned position when shooting still images.
	Del. Regist. AF Area	Deletes the focusing frame position information that was registered using [AF Area Registration].
	AF Area Auto Clear	Sets whether the focus area is displayed all the time or disappears automatically shortly after focusing.
	AF-C Area Display	Sets whether or not to display the focus area in [Continuous AF] mode.
	Phase Detect. Area	Sets the area display for phase detection AF.
 	Circ. of Focus Point	Sets whether to allow the focusing frame to jump from one end to the other when you move the focusing frame.
 	AF Frame Move Amt	Sets the distance by which the focusing frame is moved. This function is available when the focus area is set to [Spot] or [Expand Spot].
Face/Eye AF		
 	Face/Eye Prior. in AF	Sets whether or not the camera detects faces or eyes inside the focus area while performing autofocus, and then focuses on the eyes automatically (Eye AF).
 	Face/Eye Subject	Selects the target of face or eye detection.



























	 Right/Left Eye Select	Specifies the eye to be detected.
	 Face/Eye Frame Disp.	Sets whether or not to display the face/eye detection frame when a face or eyes are detected.
	Face Memory	Registers or changes the person to be given priority when focusing.
	 Regist. Faces Priority	Detects the registered face with higher priority using [Face Memory].
Focus Assistant		
	Auto Magnifier in MF	Displays an enlarged image when focusing manually.
	Focus Magnifier	Enlarges the image before shooting so that you can check the focus.
	 Focus Magnif. Time	Sets the length of time the image will be shown in an enlarged form.
	 Initial Focus Mag.	Sets the initial magnification scale when using [Focus Magnifier].
	AF in Focus Mag.	Sets whether or not to autofocus when an enlarged image is being displayed. While the enlarged image is being displayed, you can focus within a smaller area than the [Spot].
	 Initial Focus Mag.	Sets the initial magnification scale when using [Focus Magnifier].
Peaking Display		
	 Peaking Display	Sets the peaking function, which enhances the outline of in-focus areas when focusing manually.
	 Peaking Level	Sets the level of enhancement of in-focus areas.
	 Peaking Color	Sets the color used to enhance in-focus areas.













▶ (Playback) tab















Playback Target		
	Play Set of Multi. Media	Sets the memory card slot to play back when memory cards are inserted into both Slot 1 and Slot 2.
	Disp Set of Multi Media	Sets whether to display images from all memory card slots or from the slot selected in [Play Set of Multi. Media] when memory cards are inserted into both Slot 1 and Slot 2.
	Playback Filter Condition	Narrows down the images to be played back using multiple filtering conditions.
	Image Order	Sets the order in which to display images on the playback screen.
Magnification		
	 Enlarge Image	Enlarges the playback images.
	 Enlarge Initial Mag.	Sets the initial magnification scale when playing back enlarged images.
	 Enlarge Initial Position	Sets the initial magnification area when playing back enlarged images.
Selection/Memo		
	Protect	Protects recorded images against accidental erasure.
	Rating	Assigns rating to recorded images on a scale from ★ to ★★★.
	Rating Set(Custom Key)	Sets the rating (number of ★) that can be selected using the custom key to which [Rating] has been assigned with [▶ Custom Key Setting].
Delete		
	Delete	Deletes images.
	Delete confirm.	Sets whether [Delete] or [Cancel] is preselected in the delete confirmation screen.

Edit		
	Rotate	Rotates the image.
	Copy	Copies images from the memory card in the memory card slot designated in [Play Set of Multi. Media] to the memory card in the other slot.
	Photo Capture	Captures a chosen scene in a movie to save as a still image.
	 JPEG/HEIF Switch	Sets the format of still images captured with [Photo Capture] to either JPEG or HEIF.
Viewing		
	Cont. Play for 	Continuously plays back images shot using interval shooting.
	Play Speed for 	Sets the playback speed when continuously playing back still images with [Cont. Play for  Interval].
	Slide Show	Plays a slide show.
Playback Option		
	Image Index	Displays multiple images at the same time.
	Display as Group	Sets whether or not to display images shot continuously or shot using interval shooting as a group.
	Display Rotation	Sets the playback orientation for images shot vertically.
	 Focus Frame Display	Sets whether to display the focus frame during playback.
	 Aspect Marker Disp.	Sets whether or not to display the aspect marker and sets the color density for the displayed marker.
	Disp Specified Time Img.	Plays back images by specifying the shooting date and time.
	Image Jump Setting	Sets the method of jumping between playback images for the front dial and rear dial, respectively.

(Network) tab









<input type="checkbox"/> Cnct./Remote Sht.		
 	Smartphone Connection	Sets whether or not to allow a smartphone to connect to the camera.
 	Remote Shoot Function	Configures settings for remote shooting.
 	 Select on Cam & Send	Selects images on the camera and transfers them to a smartphone.
 	 Reset Transfer Status	Resets the transfer status of images that have been transferred to your smartphone.
 	<input type="checkbox"/> Cnct. while Power OFF	Sets whether or not to allow a Bluetooth connection with a smartphone when the camera is turned off.
 	Remote Shoot Setting	Configures settings for images saved when performing remote shooting using a smartphone or computer.
FTP Transfer		
 	FTP Transfer Func.	Sets image transfer using FTP and executes it. * Basic knowledge of FTP server is required.
Creators' Cloud		
 	Cloud Connection	Sets whether or not to connect to the cloud service Creators' Cloud.
 	Cloud Information	Displays information for the account of the cloud service Creators' Cloud linked to the camera and cloud connection information.
Wi-Fi		
 	Wi-Fi Connect	Sets whether to use the Wi-Fi function of the camera.
 	WPS Push	Registers an access point by pushing the Wi-Fi Protected Setup™ (WPS) button on the access point.
 	Access Point Set.	Registers an access point manually.

















	Wi-Fi Frequency Band*	Sets the frequency band for Wi-Fi communications.
	Display Wi-Fi Info.	Displays Wi-Fi information for the camera such as the MAC address, IP address, etc.
	SSID/PW Reset	Resets the SSID and password shared with devices with permission to connect to the camera.
Bluetooth		
	Bluetooth Function	Sets whether to activate or not the Bluetooth function of the camera.
	Pairing	Pairs the camera with a Bluetooth device. When the camera is connected to a paired device, the name of the device is displayed.
	Manage Paired Device	Enables you to check or delete the pairing information for devices paired with the camera.
	Bluetooth Rmt Ctrl	Sets whether or not to use a Bluetooth remote commander.
	Disp Device Address	Displays the BD address of the camera.
Wired LAN		
	LAN IP Address Setting	Selects the method for obtaining the IP address of a wired LAN.
	Display Wired LAN Info.	Displays wired LAN information for this camera such as the MAC address or IP address, etc.
USB-LAN/Tethering		
	USB-LAN Connection	Connects to the network using a USB-LAN conversion adaptor. To disconnect from the network, select [USB-LAN Disconnection].
	Tethering Connection	Connects to the network using your smartphone's tethering connection. To disconnect from the network, select [Tethering Disconnection].

























Network Option		
 	Airplane Mode	Disables wireless communications from the device such as Wi-Fi, NFC, and Bluetooth function.
 	Edit Device Name	Changes the device name under Wi-Fi Direct, etc.
 	Import Root Certificate	Imports a root certificate to the camera.
 	Access Authen. Settings	Encrypts communication between the camera and device during remote shooting or image transfer.
 	Access Authen. Info	Displays the information required when connecting the camera to a computer or smartphone using access authentication.
 	Security(IPsec)	Sets whether or not to encrypt communications between the camera and a computer while they are connected via Wi-Fi or a wired LAN.
 	Reset Network Set.	Resets all the network settings.

















* WW271448 only (see name plate on the bottom of camera)























(Setup) tab









Area/Date		
 	 Language	Selects the language.
 	Area/Date/Time Setting	Sets the area, date, and time where the camera is used.
 	NTSC/PAL Selector	Changes the TV format of the device so that you can shoot in a different movie format.
Reset/Save Settings		
 	Setting Reset	Restores settings to their defaults. Select [Initialize] to restore all settings to their default values.

	Save/Load Settings	Saves the camera settings to a memory card, or reads saved settings from the memory card.
Operation Customize		
	 Custom Key/Dial Set.	Assigns functions to the various keys and dials so that you can perform operations more quickly by pressing the keys or turning the dials when shooting still images.
	 Custom Key/Dial Set.	Assigns functions to the various keys and dials so that you can perform operations more quickly by pressing the keys or turning the dials when shooting movies.
	 Custom Key Setting	Assigns functions to the keys so that you can perform operations more quickly by pressing the keys when playing back images.
	 Fn Menu Settings	Customizes the functions displayed when the Fn (Function) button is pressed in the still image/movie shooting mode.
	 Fn Menu Settings	Customizes the functions displayed when the Fn (Function) button is pressed in the playback mode.
	Different Set for Still/Mv	For each item, select whether to set the same parameters for still images and movies or to apply parameters independently.
	DISP (Screen Disp) Set	Sets the type of information to be displayed on the monitor or in the viewfinder when the DISP button is pressed.
	 REC w/ Shutter	Sets whether or not to record movies using the shutter button.
	Zoom Ring Rotate	Assigns the zoom in/out to the rotational direction of the zoom ring. This function is only available with a power zoom lens that is compatible with this function.





Dial Customize		
 	 Custom Key/Dial Set.	Assigns functions to the various keys and dials so that you can perform operations more quickly by pressing the keys or turning the dials when shooting still images.
 	 Custom Key/Dial Set.	Assigns functions to the various keys and dials so that you can perform operations more quickly by pressing the keys or turning the dials when shooting movies.
 	My Dial Settings	Assigns the desired functions to the dials and the control wheel, and register up to three combinations of settings.
 	Av/Tv Rotate	Sets the direction of turning the front or rear dial or the control wheel to adjust the aperture value or shutter speed.
 	Function Ring(Lens)	Assigns a function to the function ring on the lens.
 	Lock Operation Parts	Sets whether to disable the multi-selector, control wheel, or front and rear dials temporarily when the Fn button is pressed and held down.
Touch Operation		
 	Touch Operation	Sets whether or not to activate the touch operation of the monitor.
 	Touch Panel/Pad	Selects whether to activate touch panel operation when shooting with the monitor, or touch pad operation when shooting with the viewfinder.
 	Touch Panel Settings	Adjusts settings related to touch panel operation.
 	Touch Pad Settings	Adjusts settings related to touch pad operation.
 	Touch Sensitivity	Sets the touch sensitivity when using touch operations.



Finder/Monitor		
	Select Finder/Monitor	Sets the method of switching between the finder/monitor displays.
	Monitor Brightness	Adjusts the brightness of the screen.
	Viewfinder Bright.	Sets the brightness of the viewfinder.
	Finder Color Temp.	Sets the color temperature of the viewfinder.
	Viewfinder Magnifi.	Sets the magnification scale of the viewfinder.
	 Display Quality	Sets the display quality. <ul style="list-style-type: none"> • When [High] is selected, the battery is consumed more quickly. • When the temperature of the camera is high, [ Display Quality] may be locked to [Standard].
	 Finder Frame Rate	Sets the frame rate for the viewfinder when shooting still images.
Display Option		
	TC/UB Disp. Setting	Sets the counter display, time code display, and user bit display.
	Gamma Display Assist	Converts movies recorded with the S-Log/HLG gamma for easier monitoring.
	Gamma Disp. Assist Typ.	Sets the method for converting movies recorded with the S-Log/HLG gamma for easier monitoring.
	 Remain Shoot Display	Sets whether or not to display an estimate indicating the number of continuously recordable images.
	 Auto Review	Sets auto review to display the captured image after shooting.

Power Setting Option		
 	Power Save Start Time	Sets the time intervals to automatically switch to power save mode.
 	Auto Power OFF Temp.	Sets the camera temperature at which the camera turns off automatically during shooting. When shooting in hand-held mode, set to [Standard].
Sound Option		
 	Playback/Monitor. Vol.	Sets the volume for movie playback.
 	 4ch Audio Monitoring	Selects the audio channel combination to output to the headphone terminals when the audio channel number is set to 4ch.
 	Audio signals	Selects whether the camera beeps during auto focus and self-timer operations.
USB		
 	USB Connection Mode	Sets the USB connection method according to the computer or USB device to be connected.
 	USB LUN Setting	Enhances compatibility by limiting the functions of USB connection. Set to [Multi] in normal conditions and to [Single] only when the connection cannot be established.
 	USB Power Supply	Sets whether to supply power via USB connection when the camera is connected to a computer or USB device.
External Output		
 	 HDMI Resolution	Sets the resolution for outputting images to a TV via HDMI when shooting still images or during playback.
 	 HDMI Output Settings	Sets the parameters for outputting images to other devices via HDMI when recording movies.

	HDMI Info. Display	Sets whether or not to output shooting information when the camera is connected to other devices via HDMI.
	CTRL FOR HDMI	Sets whether or not to operate the camera by aiming the TV remote control at the TV when the camera is connected to a TV with an HDMI cable (sold separately).
Setup Option		
	Video Light Mode	Sets the illumination setting for the HVL-LBPC LED light (sold separately).
	IR Remote Ctrl	Sets whether to use the infrared remote control.
	Anti-dust Function	Configures settings for cleaning the image sensor.
	Auto Pixel Mapping	Sets whether or not to automatically optimize the image sensor when the camera is turned off.
	Pixel Mapping	Performs image sensor optimization manually.
	Version	Displays the camera software version.
	Display Serial Number	Displays the serial number of the camera.

☆ (My Menu) tab

My Menu Setting		
	Add Item	Adds desired menu items to ☆ (My Menu).
	Sort Item	Sorts the menu items added to ☆ (My Menu).
	Delete Item	Deletes menu items added to ☆ (My Menu).
	Delete Page	Deletes all the menu items on a page in ☆ (My Menu).

	Delete All	Deletes all the menu items added to ☆ (My Menu).
	Display From My Menu	Sets whether or not to display the My Menu first when the MENU button is pressed.

Note

- The order in which the menu tabs are listed here differs from the actual display.

Identifying parts

See the pages in parentheses for details.

Front side

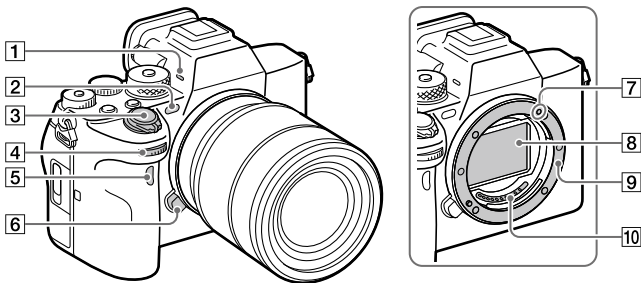

1 Microphones

Do not cover these parts during movie recording. Doing so may cause noise or lower the volume.

2 AF illuminator/Self-timer lamp/Visible light and IR sensor

Do not cover this part during shooting.

3 ON/OFF (Power) switch (9)/Shutter button (10)

4 Front dial

You can quickly adjust the settings for each shooting mode.

5 Infrared remote sensor

6 Lens release button

7 Mounting index (8)

8 Image sensor*

9 Mount

10 Lens contacts*

* Do not directly touch these parts.

7 Diopter-adjustment dial

Adjust the diopter-adjustment dial according to your eyesight until the display appears clearly in the viewfinder. If it is hard to operate the diopter-adjustment dial, remove the eyepiece cup before operating the dial.

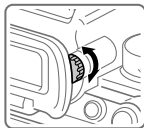

8 C1 button (Custom button 1)

9 For shooting: AF-ON (AF On) button

For viewing:  (Enlarge Image) button

10 For shooting: AEL button
[AEL hold] is assigned to the AEL button in the default settings.

For viewing:  (Image Index) button

11 Multi-selector (14)

12 For shooting: Fn (Function) button (24)

For viewing:  (Send to Smartphone) button

You can display the screen for [Send to Smartphone] by pressing this button.

13 Control wheel (13)

14 Access lamp

15 For shooting: C4 button (Custom button 4)
For viewing:  (Delete) button

16  (Playback) button

Top side

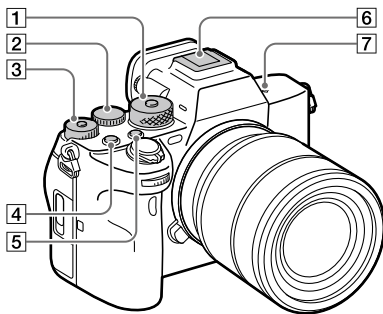

- 1 Mode dial (15)**
The mode dial is unlocked while you hold down the unlock button at the center.
- 2 Rear dial**
You can quickly adjust the settings for each shooting mode.
- 3 Exposure compensation dial**
Pressing the lock button at the center switches the exposure compensation dial between the locked and unlocked status. The dial is unlocked when the lock button is popped up and the white line is visible.
- 4 MOVIE (Movie) button**
- 5 C2 button (Custom button 2)**
- 6 Multi Interface Shoe***
Some accessories may not go in all the way and protrude backward from the Multi interface shoe. However, when the accessory reaches the front end of the shoe, the connection is completed.

7  Image sensor position mark

- The image sensor is the sensor that converts light into an electric signal. The  mark shows the location of the image sensor. When you measure the exact distance between the camera and the subject, refer to the position of the horizontal line.

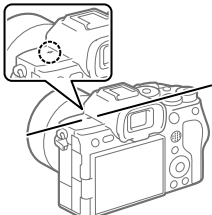

- If the subject is closer than the minimum shooting distance of the lens, the focus cannot be confirmed. Make sure you put enough distance between the subject and the camera.

- * For details on compatible accessories for the Multi Interface Shoe, visit the Sony website, or consult your Sony dealer or local authorized Sony service facility. Accessories for the Accessory Shoe can also be used. Operations with other manufacturers' accessories are not guaranteed.

 Multi Interface Shoe

Accessory Shoe

Sides

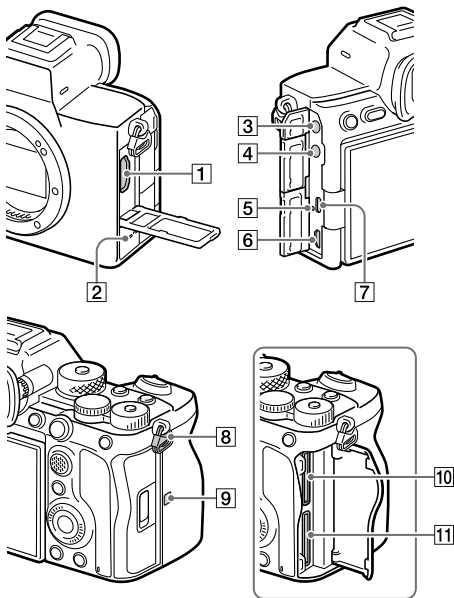

- 1 HDMI Type-A terminal
- 2 Speaker
- 3 (Microphone) jack
When an external microphone is connected, the built-in microphone turns off automatically. When the external microphone is a plugin-power type, the power of the microphone is supplied by the camera.
- 4 (Headphones) jack
- 5 Charge lamp
- 6 Multi/Micro USB Terminal*
This terminal supports Micro USB-compatible devices.
- 7 USB Type-C terminal

- 8** Hooks for shoulder strap
Attach both ends of the strap onto the camera.

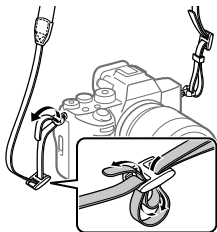

- 9** **N** (N-Mark)
- The camera cannot be connected to a smartphone using the NFC function if the camera's system software (firmware) is Ver.3.0 or later.
 - NFC (Near Field Communication) is an international standard of short-range wireless communication technology.

- 10** SLOT 1 (Memory card slot 1)
(8)

- 11** SLOT 2 (Memory card slot 2)
(8)

* For details on compatible accessories for the Multi/Micro USB Terminal, visit the Sony website, or consult your Sony dealer or local authorized Sony service facility.

Notes on USB terminals

You can use either the USB Type-C terminal or the Multi/Micro USB Terminal for USB communications. However, you cannot conduct USB communications with both terminals simultaneously. Use the USB Type-C terminal to supply power and charge the battery pack.

This camera cannot be powered via the Multi/Micro USB terminal.

- You can use accessories for the Multi/Micro USB Terminal, such as a remote commander (sold separately), while supplying power or performing remote shooting using the USB Type-C terminal.

Notes on the terminal cover

Ensure that the terminal cover is closed before use.

■ Notes on the cable protector

Use the cable protector to prevent a cable from being disconnected when shooting images with the cable connected.

To attach the cable protector

- ① Open the HDMI terminal cover, headphone terminal cover, and USB terminal cover.
- ② Fit the hook of the cable protector into the notch below the Multi/Micro USB terminal, and press down so that it does not come off, and then attach it so that it covers the terminal surface of the unit.
- ③ Push the attachment screw in and turn it to secure the cable protector.
- ④ Insert the cable into one of the jacks.
- ⑤ Insert the cable into the holding part and then secure the cable with the fixing dial.

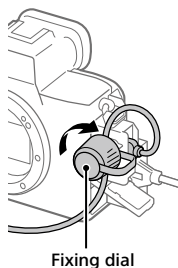
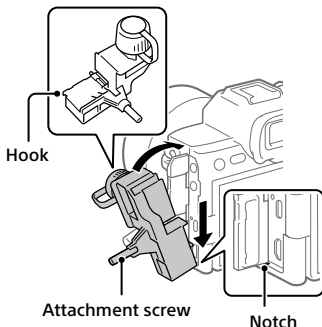

To remove the cable protector

Loosen the attachment screw, and then remove the cable protector.

Bottom

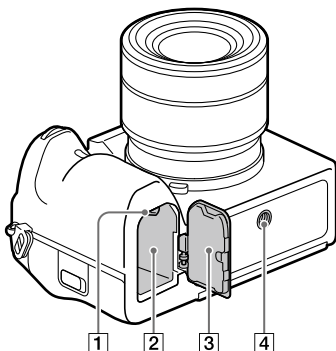

1 Lock lever (7)

2 Battery insertion slot (7)

3 Battery cover (7)

When attaching an accessory such as a vertical grip (sold separately), remove the battery cover.

To remove the battery cover

Pull the battery cover release lever in the direction of the arrow, and then remove the battery cover.

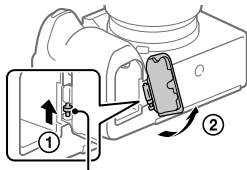

Battery cover release lever

To attach the battery cover

Insert the shaft on one side of the battery cover into the attachment site, and then push in the battery cover by attaching the shaft on the opposite side.

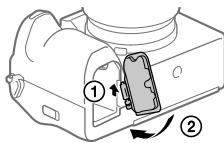

4 Tripod socket hole

Supports 1/4-20 UNC screws

Use a tripod with a screw less than 5.5 mm (7/32 inches) long. Otherwise, you cannot firmly secure the camera, and damage to the camera may occur.

Basic icons







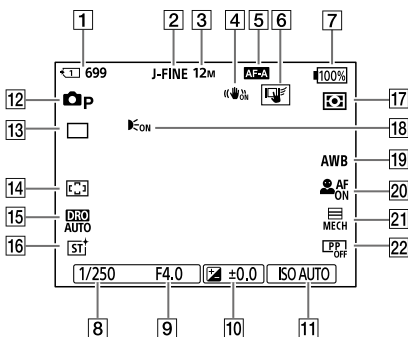

This section describes the screen display when the shooting mode is **P** (Program Auto).

- The following is an example of the display when [DISP (Screen Disp) Set] is set to [Display All Info.] and the touch function icons are hidden.
- The displayed content and positions are for reference only, and may differ from the actual display. Some icons may not be displayed depending on the camera settings.
- For information on how to show/hide the touch function icons and examples of the touch function icon display, refer to “Touch function icons” (page 11).
- For other icons, refer to the “Help Guide.”

During still image shooting



- 1 Slot number of the memory card recording the shooting data and recordable number of still images
- 2 [JPEG/HEIF Switch] is set to [JPEG].
[JPEG Quality] is set to [Fine].
- 3 [JPEG Image Size] is set to [L: 12M].
- 4 [SteadyShot] is set to [On].

- 5  Focus Mode] is set to [Automatic AF].
- 6 [Touch Func. in Shooting] is set to [Touch Tracking].
- 7 Remaining battery level
- 8 Shutter speed
- 9 Aperture value
- 10 Exposure compensation
- 11  ISO] is set to [ISO AUTO].
- 12 The mode dial is set to **P** (Program Auto).
- 13 [Drive Mode] is set to [Single Shooting].
- 14  Focus Area] is set to [Wide].
- 15 [D-Range Optimizer: Auto] is selected.
- 16  Creative Look] is set to [ST].
- 17  Metering Mode] is set to [Multi].
- 18 Displayed when [AF Illuminator] is set to [Auto] and the camera detects that the AF Illuminator is required.
- 19  White Balance] is set to [Auto].
- 20  Face/Eye Prior. in AF] is set to [On] and  Face/Eye Subject] is set to [Human].
- 21 [Shutter Type] is set to [Mechanical Shutter].
- 22  Picture Profile] is set to [Off].

During movie recording

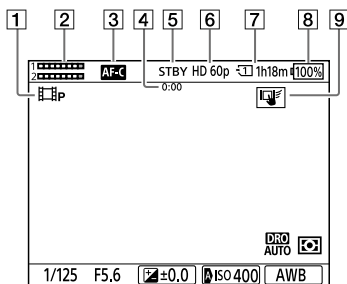

- 1 The mode dial is set to **P** (Program Auto).
- 2 Audio level
- 3 [Focus Mode] is set to [Continuous AF].
- 4 Actual shooting time of the movie
- 5 The camera is in the shooting standby mode.
- 6 [File Format] is set to [XAVC S HD] and [Rec Frame Rate] is set to [60p].
- 7 Slot number of the memory card recording the shooting data and recordable movie time
- 8 Remaining battery level
- 9 [Touch Func. in Shooting] is set to [Touch Tracking].

Notes on using your camera

Along with this section, also see “Precautions” in the Help Guide.

Notes on handling the product

- This camera is designed to be dust resistant and splash resistant, but it is not guaranteed to completely prevent the ingress of dust or water droplets.
- Do not leave the lens or the viewfinder exposed to a strong light source such as sunlight. Because of the lens’s condensing function, doing so may cause smoke, fire, or a malfunction inside the camera body or the lens. If you have to leave the camera exposed to a light source such as sunlight, attach the lens cap to the lens.
- If sunlight or a strong light source enters the camera through the lens, it may focus inside the camera and cause smoke or fire. Attach the lens cap to the lens when storing the camera. When you shoot with backlighting, keep the sun sufficiently far away from the angle of view. Note that smoke or fire may occur even if the light source is slightly away from the angle of view.
- Do not directly expose the lens or the viewfinder to beams such as laser beams. This may damage the image sensor or the inside of the viewfinder and cause the camera to malfunction.
- Do not look at sunlight or a strong light source through the lens when it is detached. This may result in unrecoverable damage to the eyes.
- This camera (including accessories) has magnet(s) which may interfere with pacemakers, programmable shunt valves for hydrocephalus treatment, or other medical devices. Do not place this camera close to persons who use such medical devices. Consult your doctor before using this camera if you use any such medical device.
- Increase the volume gradually. Sudden loud noises can damage your ears. Be especially careful when listening to headphones.
- Do not leave the camera, the supplied accessories, or memory cards within the reach of infants. They may be accidentally swallowed. If this occurs, consult a doctor immediately.

Notes on the monitor and electronic viewfinder

- The monitor and electronic viewfinder are manufactured using extremely high-precision technology, and over 99.99% of the pixels are operational for effective use. However, there may be some small black dots and/or bright dots (white, red, blue or green in color) that constantly appear on the monitor and electronic viewfinder. These dots are normal due to the manufacturing process and do not affect the images in any way.
- When shooting with the viewfinder, you may experience symptoms such as eyestrain, fatigue, travel sickness, or nausea. We recommend that you take a break at regular intervals when you are shooting with the viewfinder.
- If the monitor or electronic viewfinder is damaged, stop using the camera immediately. The damaged parts may harm your hands, face, etc.

Notes on continuous shooting

During continuous shooting, the monitor or viewfinder may flash between the shooting screen and a black screen. If you keep watching the screen in this situation, you may experience uncomfortable symptoms such as feeling of unwellness. If you experience uncomfortable symptoms, stop using the camera, and consult your doctor as necessary.

Notes on recording/streaming for long periods of time and recording 4K movies

- The camera body and battery may become warm with use – this is normal.
- If the same part of your skin touches the camera for a long period of time while using the camera, even if the camera does not feel hot to you, it may cause symptoms of a low-temperature burn such as redness or blistering. Pay special attention in the following situations and use a tripod, etc.
 - When using the camera in a high-temperature environment
 - When someone with poor circulation or impaired skin sensation uses the camera
 - When using the camera with the [Auto Power OFF Temp.] set to [High].

Notes on using memory cards

- When recording is finished, the memory card may become hot. This is not a malfunction.
- If  (overheating warning icon) is displayed on the monitor, do not remove the memory card from the camera right away. Instead, wait for a while after turning off the camera, and then remove the memory card. If you touch the memory card while it is hot, you may drop it and the memory card may be damaged. Be careful when removing the memory card.

Sony lenses/accessories

Using this unit with products from other manufacturers may affect its performance, leading to accidents or malfunction.

On the data specifications described in this manual

The data on performance and specifications are defined under the following conditions, except as described in this manual: at an ordinary ambient temperature of 25°C (77°F), and using a battery pack that has been fully charged until the charge lamp has turned off.

Warning on copyright

Television programs, films, videotapes, and other materials may be copyrighted. Unauthorized recording of such materials may be contrary to the provisions of the copyright laws.

Notes on location information

If you upload and share still images or movies taken with this camera on the Internet while the location information is linked with the dedicated smartphone application, you may accidentally reveal the location information to a third party. To prevent third parties from obtaining your location information, deactivate the [Location Information Linkage] function of the dedicated application.

Notes on discarding or transferring this product to others

When discarding or transferring this product to others, make sure to perform the following operation to protect private information.

- [Setting Reset] → [Initialize]

Notes on discarding or transferring a memory card to others

Executing [Format] or [Delete] on the camera or a computer may not completely delete the data on the memory card. When transferring a memory card to others, we recommend that you delete the data completely using data deletion software. When discarding a memory card, we recommend that you physically destroy it.

Note on network functions

When you use network functions, unintended third parties on the network may access the camera, depending on the usage environment.

For example, unauthorized access to the camera may occur in network environments to which another network device is connected or can connect without permission. Sony bears no responsibility for any loss or damage caused by connecting to such network environments.

Note on the 5 GHz band for wireless LAN

When using the wireless LAN function outdoors, set the band to 2.4 GHz by following the procedure below. (WW271448 only)

- MENU →  (Network) → [Wi-Fi] → [Wi-Fi Frequency Band]

How to turn off wireless network functions (Wi-Fi, etc.) temporarily

When you board an airplane, etc., you can turn off all wireless network functions temporarily using [Airplane Mode].

Power Cord

Multiple power cords may be supplied with this equipment. Use the appropriate one that matches your country/region.

For the customers in the UK, Ireland, Malta and Cyprus

Use the power cord (A).

For safety reasons, the power cord (B) is not intended for above countries/regions and shall therefore not be used there.

For the customers in other EU countries/regions and Israel

Use the power cord (B).

For safety reasons, the power cord (A) is not intended for above countries/regions and shall therefore not be used there.

(A)



(B)



For Customers in the U.S.A.

For question regarding your product or for the Sony Service Center nearest you, call 1-800-222-SONY (7669).

Supplier's Declaration of Conformity

Trade Name: SONY

Model : WW271448

Responsible Party: Sony Electronics Inc.

Address: 16535 Via Esprillo, San Diego, CA 92127 U.S.A.

Telephone Number: 858-942-2230

For Customers in Europe

Hereby, Sony Corporation declares that this equipment is in compliance with the UK relevant statutory requirements.

The full text of the declaration of conformity is available at the following internet address: <https://compliance.sony.co.uk>

The power delivered by the charger must be between min 2.5 Watts required by the radio equipment, and max 27 Watts in order to achieve the maximum charging speed.

USB PD fast charging



Troubleshooting

If you experience trouble with the product, try the following solutions.

❶ Refer to the "Help Guide."

❷ Remove the battery pack, wait for about one minute, re-insert the battery pack, then turn on the power.

❸ Initialize the settings.

❹ Consult your dealer or local authorized service facility. Additional information on this product and answers to frequently asked questions can be found at our Customer Support Website.

Americas

<https://www.sony.com/am/support>

Europe

<https://www.sony.eu/support>

Asia-Pacific, Oceania, Middle East and Africa

<https://www.sony-asia.com/support>

Memory cards that can be used

This camera supports CFexpress Type A memory cards and SD memory cards (UHS-I and UHS-II compatible).

When using microSD memory cards with this camera, be sure to use the appropriate adaptor.

For still-image shooting

The following memory cards can be used.

- CFexpress Type A memory cards
- SD/SDHC/SDXC memory cards

For movie recording

Movie recording formats and compatible memory cards are as follows.

 File Format	Maximum recordable bit-rate	Supported memory card
XAVC HS 4K	280Mbps	• CFexpress Type A memory card (VPG200 or higher) • SDXC card V60 or higher
XAVC S 4K	280Mbps	
XAVC S HD	100Mbps	• CFexpress Type A memory card • SDHC/SDXC card (U3 or higher)
XAVC S-I 4K	600Mbps	• CFexpress Type A memory card (VPG200 or higher) • SDXC card V90 or higher
XAVC S-I HD	222Mbps	

For information on memory cards that can be used for [S&Q Motion] shooting, refer to the "Help Guide."

Hint

- When the recording bit-rate is 200 Mbps, you can also record using an SDXC card (U3/V30).

Note

- When shooting a proxy movie, a higher-speed memory card may be required.
- CFexpress Type B memory cards cannot be used.
- When an SDHC memory card is used to record movies over extended periods of time, the recorded movies are divided into files 4 GB in size.
- When recording a movie on memory cards in both the Slot 1 and the Slot 2 with following camera settings, insert two memory cards with the same file system.

Movies cannot be recorded simultaneously when using a combination of the exFAT file system and FAT32 file system.

Memory card	File system
CFexpress Type A memory card, SDXC memory card	exFAT
SDHC memory card	FAT32

- Charge the battery pack sufficiently before attempting to recover the database files on the memory card.

Specifications

Camera

[System]

Camera Type:

Interchangeable Lens Digital Camera

Lens: Sony E-mount lens

[Image sensor]

Image format: 35 mm full frame
(35.6 mm × 23.8 mm), CMOS image sensor

Effective pixel number of camera:

Approx. 12 100 000 pixels

Total pixel number of camera:

Approx. 12 900 000 pixels

[SteadyShot]

In-camera sensor shift image stabilization system

[Anti-Dust]

Anti-dust function implementing antistatic coating and ultrasonic vibration

[Auto focus system]

Detection system: Phase detection system/Contrast detection system

Sensitivity Range: -6 EV to +20 EV (at ISO 100 equivalent, F2.0)

[Electronic Viewfinder]

Type: 1.6 cm (0.64 type)

Electronic Viewfinder

Total number of dots: 9 437 184 dots

Magnification: Approx. 0.90× with 50 mm lens at infinity, -1 m⁻¹

Eye Point: Approx. 25 mm from the eyepiece and approx. 21 mm from the eyepiece frame at -1 m⁻¹

Diopter Adjustment:

-4.0 m⁻¹ to +3.0 m⁻¹

[Monitor]

7.5 cm (3.0 type) TFT drive, touch panel

Total number of dots: 1 440 000 dots

[Exposure control]

Metering method: 1 200-zone evaluative metering

Metering Range: -3 EV to +20 EV (at ISO 100 equivalent with F2.0 lens)

ISO sensitivity (Recommended exposure index):

Still images: ISO 80 to ISO 102400

(Extended ISO: Minimum ISO 40, maximum ISO 409600)

Movies: ISO 80 to ISO 102400

equivalent (Extended ISO:

maximum equivalent to

ISO 409600)

[Shutter]

Type: Electronically-controlled, vertical-traverse, focal-plane type

Speed range:

Still images: 1/8 000 second to 30 seconds, BULB

Movies: 1/8 000 second to

1/4 second (1/3 EV step)

60p-compatible devices

(50p-compatible devices):

up to 1/60 (1/50) second in AUTO

mode (up to 1/30 (1/25) second in Auto slow shutter mode)

Flash sync speed: 1/250 second (when using a flash manufactured by Sony)

[Recording format]

File format: JPEG (DCF Ver. 2.0, Exif Ver. 2.32, MPF Baseline compliant), HEIF (MPEG-A MIAF compliant), RAW (Sony ARW 5.0 format compliant)

Movies (XAVC HS format):

XAVC Ver2.1: compliant with the MP4 format
Video: MPEG-H HEVC/H.265
Audio: LPCM 2ch (48 kHz 16 bits),
LPCM 4ch (48 kHz 24 bits)*1
LPCM 2ch (48 kHz 24 bits)*1
MPEG-4 AAC-LC 2ch*2

Movies (XAVC S format):

XAVC Ver2.1: compliant with the MP4 format
Video: MPEG-4 AVC/H.264
Audio: LPCM 2ch (48 kHz 16 bits),
LPCM 4ch (48 kHz 24 bits)*1
LPCM 2ch (48 kHz 24 bits)*1
MPEG-4 AAC-LC 2ch*2

*1 When using accessories that support 4ch output and 24 bits with the Multi Interface Shoe

*2 Proxy movies

[Recording media]

SLOT 1/SLOT 2:

Slots for CFexpress Type A memory cards and SD cards (UHS-I and UHS-II compatible)

[Input/output terminals]

USB Type-C terminal:

SuperSpeed USB 5 Gbps (USB 3.2)
USB Power Delivery compatible

Multi/Micro USB Terminal*:

Hi-Speed USB (USB 2.0)

* Supports Micro USB compatible devices.

HDMI: HDMI Type-A terminal

🎧 (Microphone) terminal:

∅ 3.5 mm Stereo mini jack

🎧 (Headphones) terminal:

∅ 3.5 mm Stereo mini jack

[General]

Rated input: 7.2 V , 4.3 W

Operating temperature:

0 to 40 °C (32 to 104 °F)

Storage temperature:

-20 to 55 °C (-4 to 131 °F)

Dimensions (W/H/D) (Approx.):

128.9 × 96.9 × 80.8 mm

128.9 × 96.9 × 69.7 mm

(from grip to monitor)

5 1/8 × 3 7/8 × 3 1/4 in.

5 1/8 × 3 7/8 × 2 3/4 in.

(from grip to monitor)

Mass (Approx.):

699 g (1 lb 8.7 oz) (including battery pack, SDXC memory card)

[Wireless LAN]

WW271448 (see name plate on the bottom of camera)

Supported format:

IEEE 802.11 a/b/g/n/ac

Frequency band: 2.4 GHz/5 GHz

Security:

WEP/WPA-PSK/WPA2-PSK/WPA3-SAE

Connection method:

Wi-Fi Protected Setup™ (WPS)/

Manual

Access method: Infrastructure mode

WW389565 (see name plate on the bottom of camera)

Supported format:

IEEE 802.11 b/g/n

Frequency band: 2.4 GHz

Security:

WEP/WPA-PSK/WPA2-PSK/WPA3-SAE

Connection method:

Wi-Fi Protected Setup™ (WPS)/

Manual

Access method: Infrastructure mode

[NFC]

Tag type: NFC Forum Type 3 Tag compliant

[Bluetooth communications]

Bluetooth standard Ver. 5.0
Frequency band: 2.4 GHz

Battery charger

BC-QZ1/BC-QZ1 T

Rated input:

100 - 240 V , 50/60 Hz, 0.38 A

Rated output: 8.4 V , 1.6 A

Rechargeable battery pack

NP-FZ100



Rated voltage: 7.2 V 

Design and specifications are subject to change without notice.

On image data compatibility

- This camera conforms with DCF (Design rule for Camera File system) universal standard established by JEITA (Japan Electronics and Information Technology Industries Association).
- Playback of images recorded with your camera on other equipment and playback of images recorded or edited with other equipment on your camera are not guaranteed.

Trademarks

- XAVC S and  are registered trademarks of Sony Corporation.
- XAVC HS and  are registered trademarks of Sony Corporation.
- Mac is a trademark of Apple Inc., registered in the United States and other countries.
- USB Type-C® and USB-C® are registered trademarks of USB Implementers Forum.
- The terms HDMI, HDMI High-Definition Multimedia Interface, and the HDMI Logo are trademarks or registered trademarks of HDMI Licensing Administrator, Inc.
- Microsoft and Windows are registered trademarks or trademarks of Microsoft Corporation in the United States and/or other countries.
- SDXC logo is a trademark of SD-3C, LLC.
- The CFexpress Type A logo is a trademark licensed by the CompactFlash Association.
- Wi-Fi, the Wi-Fi logo and Wi-Fi Protected Setup are registered trademarks or trademarks of the Wi-Fi Alliance.
- The N-Mark is a trademark or registered trademark of NFC Forum, Inc. in the United States and in other countries.

- The Bluetooth® word mark and logos are registered trademarks owned by the Bluetooth SIG, Inc. and any use of such marks by Sony Corporation is under license.
- QR Code is a trademark of Denso Wave Inc.
- In addition, system and product names used in this manual are, in general, trademarks or registered trademarks of their respective developers or manufacturers. However, the ™ or ® marks may not be used in all cases in this manual.



Additional information on this product and answers to frequently asked questions can be found at our Customer Support Website.

<https://www.sony.net/>

A

AF-A.....	31
AF-C.....	31
AF-S.....	31
Automatic AF.....	31

C

Cable protector.....	75
Charging.....	7
Cloud.....	44
Computer.....	43
Continuous AF.....	31
Control wheel.....	13
Cont. Shooting.....	40
Creators' App.....	42
Creators' Cloud.....	44
Custom Key/Dial Set.....	27

D

Diopter-adjustment.....	70
Direct manual focus.....	31
DISP button.....	28
DMF.....	31
Drive Mode.....	39

E

Expand Spot.....	33
Eye AF.....	36
Eye sensor.....	69

F

Fn.....	24
Focus.....	31
Focus Area.....	33
Focus indicator.....	32

Focus Mode.....	31
Function button.....	24

H

Help Guide.....	2
-----------------	---

I

Imaging Edge Desktop.....	43
In-Camera Guide.....	2
Initial setup.....	9

L

Language.....	61
Lens.....	8
List of icons.....	77

M

Main menu (shooting setting list).....	21
Manual Focus.....	31
Memory card.....	8, 85
MENU button.....	18
MF.....	31
Mode dial.....	15
Monitor.....	77
Multi Interface Shoe.....	71
Multi-selector.....	14

P

Phase detection AF.....	36
-------------------------	----

S

Shooting still images.....	10
Single Shooting.....	39
Single-shot AF.....	31
Smartphone Connection.....	42

Software	43
Specifications	87
Spot	33

T

Touch Focus	41
Touch function icons.....	11
Touch pad	41
Touch Shutter.....	41
Touch Tracking	41
Tracking.....	33



<https://www.sony.net/SonyInfo/Support/>

