

Flash
HVL-F60RM/HVL-F60RM2/HVL-F46RM

Use this Help Guide when you have issues or questions on how to use your flash unit.

HVL-F60RM2/HVL-F46RM: Regarding the compatibility with cameras equipped with global shutter image sensor

To use the global shutter sync photography, you need to update the software in the HVL-F60RM2/HVL-F46RM to version 2.00 or later. Update to the latest version to use it.

For details about the global shutter sync photography, view [here](#).

Compatible cameras



HVL-F60RM

For camera models compatible with the HVL-F60RM flash unit, view [here](#). (Another window will open.)



HVL-F60RM2

For camera models compatible with the HVL-F60RM2 flash unit, view [here](#). (Another window will open.)



HVL-F46RM

For camera models compatible with the HVL-F46RM flash unit, view [here](#). (Another window will open.)

Support information



Radio wireless flash photography

For an overview with preparation and usage examples for radio wireless flash photography, view [here](#). (Another window will open.)

[About this Help Guide](#)

Locating parts and controls/on-screen indicators

[Locating parts and controls \(HVL-F60RM/HVL-F60RM2\)](#)

[Locating parts and controls \(HVL-F46RM\)](#)

Basic operations

[Using the control wheel](#)

[Using the Quick Navi screen](#)

[Using the MENU screen](#)

[Direct setting \(HVL-F60RM/HVL-F60RM2\)](#)

[On-screen indicators \(HVL-F60RM/HVL-F60RM2\)](#)

[On-screen indicators \(HVL-F46RM\)](#)

Preparations

[Unpacking](#)

[Inserting batteries](#)

[Attaching/removing the flash unit to/from the camera](#)

[Attaching and removing the mini-stand](#)

[Removing/attaching the dust and moisture resistant cover \(HVL-F60RM2/HVL-F46RM\)](#)

[Turning on the power to the flash unit \(HVL-F60RM/HVL-F60RM2\)](#)

[Turning on the power to the flash unit \(HVL-F46RM\)](#)

[Pairing with a radio wireless commander/receiver <for radio wireless flash photography>](#)

Photographing

[TTL flash photography <TTL>](#)

[Manual flash photography <MANUAL>](#)

[High-speed sync photography <HSS>](#)

[Global shutter sync photography \(HVL-F60RM2/HVL-F46RM\)](#)

[Multiple flash photography <MULTI>](#)

[Firing a test-flash](#)

[Selecting the wireless type for controlling wireless flash photography <radio or optical> \(HVL-F60RM\)](#)

Radio wireless flash photography

[Configuring the flash unit for radio wireless flash photography](#)

[Wireless flash photography <with the receiver unit>](#)

[Multiple radio wireless flash photography with flash power level ratio control](#)

[Multiple wireless flash photography <group flash photography>](#)

[Remote release photography \(HVL-F60RM/HVL-F60RM2\)](#)

[Changing the settings of individual receiver units <RECEIVER SET>](#)

[Notes on radio wireless flash photography](#)

Optical wireless flash photography (HVL-F60RM)

[Configuring the flash unit for optical wireless flash photography \(HVL-F60RM\)](#)

[Wireless flash photography <with the remote unit> \(HVL-F60RM\)](#)

[Multiple optical wireless flash photography with flash power level ratio control \(HVL-F60RM\)](#)

[Notes on optical wireless flash photography \(HVL-F60RM\)](#)

[Using the sync terminal for flash photography \(HVL-F60RM/HVL-F60RM2\)](#)

[Using the LED light for video shooting \(HVL-F60RM\)](#)

[Selecting the flash coverage automatically <auto zoom>](#)

[Selecting the flash coverage manually <manual zoom>](#)

Bounce flash photography

[Bounce flash photography](#)

[Adjusting the bounce flash angle](#)

[Using the quick shift bounce function \(HVL-F60RM/HVL-F60RM2\)](#)

[Using the bounce adaptor \(HVL-F60RM/HVL-F60RM2\)](#)

[Close-up flash photography <downward bounce flash photography>](#)

[Tips on the AF illuminator \(HVL-F60RM\)](#)

[Using color filters \(HVL-F60RM/HVL-F60RM2\)](#)

[Connecting an external power source \(HVL-F60RM/HVL-F60RM2\)](#)

Customizing

[Registering/calling up a preference <MEMORY>](#)

[Customizing the button assignment <CUSTOM KEY>](#)

[Viewing the version information of this flash unit/the receiver unit <VERSION>](#)

[Resetting the settings for the Quick Navi screen <RESET>](#)

[Restoring the factory default settings <INITIALIZE>](#)

Notes on using/cleaning the flash unit

[Notes on use](#)

Specifications

[Specifications](#)

[Guide number \(HVL-F60RM/HVL-F60RM2\)](#)

[Guide number \(HVL-F46RM\)](#)

[Radio wireless features](#)

[Trademarks](#)

[License](#)

Troubleshooting

[Warning indications](#)

Flash
HVL-F60RM/HVL-F60RM2/HVL-F46RM

About this Help Guide

This Help Guide is provided for 3 flash unit models: HVL-F60RM/HVL-F60RM2/HVL-F46RM.
The illustrations used for common descriptions are of the HVL-F60RM flash unit.

Flash
HVL-F60RM/HVL-F60RM2/HVL-F46RM

Locating parts and controls (HVL-F60RM/HVL-F60RM2)

Flash unit (front side)

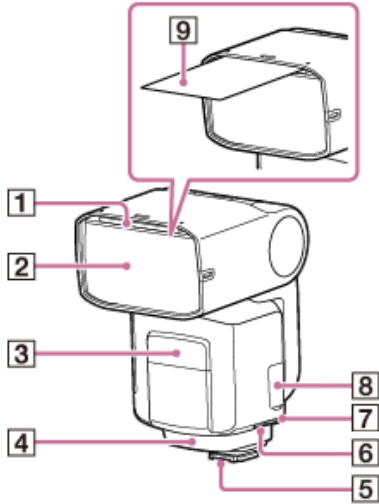

1. Built-in wide panel
2. Flashlamp
3. LED light unit/AF illuminator (HVL-F60RM)
4. Wireless control signal receiver (for optical wireless communications) (HVL-F60RM)
5. Multi Interface foot
6. DC IN terminal
Connect the External Battery Adaptor (not supplied) to this terminal.
7. Sync terminal
8. Multi/Micro USB terminal
9. Bounce sheet

Flash unit (back side)

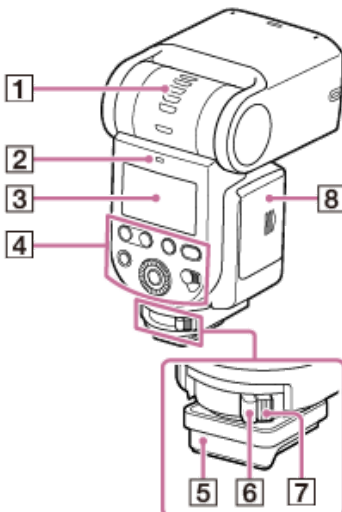

1. Bounce indicator (upper/lower angle)

2. LINK lamp
3. LCD panel
4. Operation console
5. Dust and moisture resistant cover (HVL-F60RM2)
6. Lock lever
7. Release button
8. Battery chamber door

Mini-stand

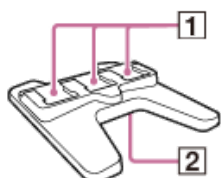

1. Shoes for the Multi Interface foot
2. Tripod attachment hole

Controls on the operation console

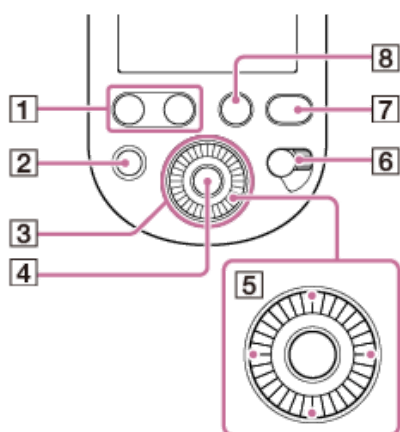

1. LEVEL +/- button
By using either button, you can quickly adjust the flash compensation and the flash power level.
2. TEST button
3. Control wheel
4. Center button
5. Direction buttons
6. Power switch
By selecting "LOCK," you can disable the control wheel and the buttons on the flash unit to prevent unintentional operations.
7. MENU button
8. Fn button

About the LCD backlight

Every time you press one of the buttons or use the control wheel on the operation console, the backlights for the LCD panel and the buttons (HVL-F60RM) light according to the backlight setting. While the backlights are lit, you can keep them lit longer by pressing any button or using the control wheel once again. To change the backlight setting, select [BACKLIGHT] on the MENU screen. You can select one of the following setting options.

AUTO1 (HVL-F60RM):

When you press one of the buttons or use the control wheel, the backlight for the LCD panel lights for 8 seconds. The backlights for the LEVEL -/+, Fn, and MENU buttons stay lit. (factory default setting)

AUTO2 (HVL-F60RM)/AUTO (HVL-F60RM2):

When you press one of the buttons or use the control wheel, the backlight for the LCD panel lights for 8 seconds.

ON:

- HVL-F60RM: The backlights for the LCD panel and the LEVEL -/+, Fn, and MENU buttons stay lit.
- HVL-F60RM2: The backlight for the LCD panel stays lit.

OFF:

All the backlights stay unlit.

Flash
HVL-F60RM/HVL-F60RM2/HVL-F46RM

Locating parts and controls (HVL-F46RM)

Flash unit (front side)

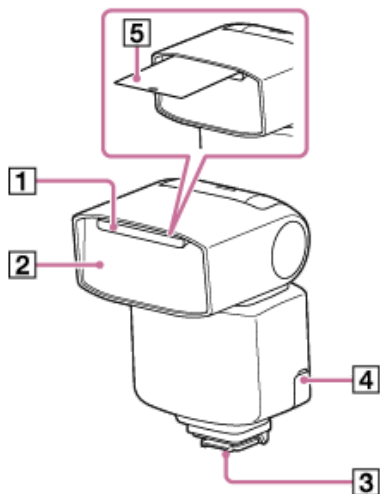

1. Built-in wide panel
2. Flashlamp
3. Multi Interface foot
4. Multi/Micro USB terminal
5. Bounce sheet

Flash unit (back side)

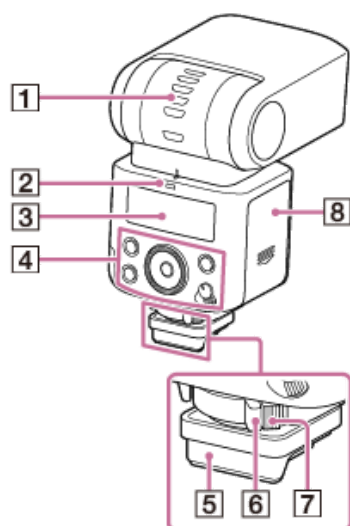

1. Bounce indicator (upper/lower angle)
2. LINK lamp
3. LCD panel
4. Operation console
5. Dust and moisture resistant cover
6. Lock lever

7. Release button
8. Battery chamber door

Mini-stand

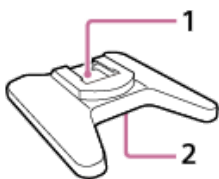

1. Shoes for the Multi Interface foot
2. Tripod attachment hole

Controls on the operation console

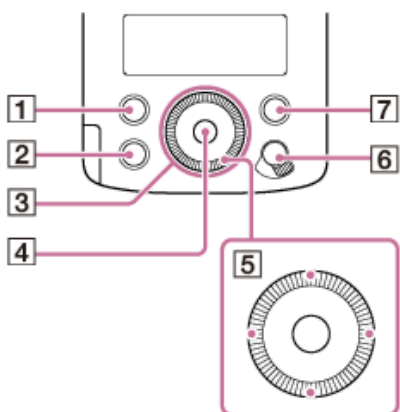

1. Fn button
2. TEST button
3. Control wheel
4. Center button
5. Direction buttons
6. Power switch
7. MENU button

By selecting "LOCK," you can disable the control wheel and the buttons on the flash unit to prevent unintentional operations.

About the LCD backlight

Every time you press one of the buttons or use the control wheel on the operation console, the backlight for the LCD panel lights according to the backlight setting. While the backlight is lit, you can keep it lit longer by pressing any button or using the control wheel once again. To change the backlight setting, select [BACKLIGHT] on the MENU screen. You can select one of the following setting options.

AUTO:

When you press one of the buttons or use the control wheel, the backlight for the LCD panel lights for 8 seconds. (factory default setting)

ON:

The backlight for the LCD panel stays lit.

OFF:

The backlight stays unlit.

Flash
HVL-F60RM/HVL-F60RM2/HVL-F46RM

Using the control wheel

By rotating the control wheel or pressing the direction buttons, you can move the focus or change the setting item value on the Quick Navi screen or the MENU screen. Select the setting item of your choice and press the center button to enable the setting option.

Note

- The illustrations used in this topic are of the HVL-F60RM flash unit.

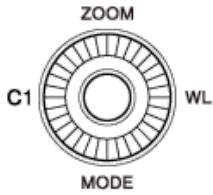

To the direction buttons and the control wheel, the following functions are assigned at shipment.

Operations	Functions	Descriptions
Up	ZOOM	Changes the flash coverage (zoom).
Down	MODE	Changes the flash mode.
Left (HVL-F60RM/HVL-F60RM2)	-	No function is assigned to this button at shipment. You can assign a function of your choice to the button.
Left (HVL-F46RM)	$\frac{4}{5}$ /LEVEL	Changes the flash compensation/power level.
Right	WL MODE	Changes the wireless mode.
Control wheel	-	No function is assigned to this button at shipment. You can assign a function of your choice to the button.

Hint

- To the control wheel, the individual direction button, and the center button, you can assign the function of your choice.

Related Topic

- [Customizing the button assignment <CUSTOM KEY>](#)

Flash
HVL-F60RM/HVL-F60RM2/HVL-F46RM

Using the Quick Navi screen

You can press the Fn button on the flash unit to change the settings for photography, such as the selected flash mode, in accordance with the on-screen indications. Select the setting item of your choice and rotate the control wheel to change the setting option.

1 Press the Fn button.

2 Select the setting item of your choice with the direction buttons.

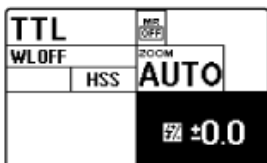

Pressing the center button following the above operation displays the specific screen for setting the selected item.

3 Rotate the control wheel to change the setting option.

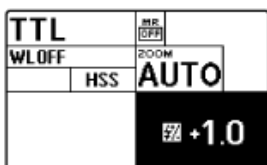

4 Press the Fn button.

On the Quick Navi screen, you can change the following setting options.

Setting items	Descriptions	Setting options
TTL	Flash mode setting	TTL(*)/MANUAL/MULTI/flash off/GROUP
WLOFF	Wireless mode setting	HVL-F60RM: WL OFF(*)/CMD/RCV(radio control) WL OFF(*)/CTRL/RMT(optical control) HVL-F60RM2/HVL-F46RM: WL OFF(*)/CMD/RCV(radio control)
HSS	High-speed sync setting	HVL-F60RM: ON(*)/OFF HVL-F60RM2/HVL-F46RM: ON/OFF(*)
zoom AUTO	Flash coverage (zoom) setting	HVL-F60RM/HVL-F60RM2: AUTO(*)/20-200 HVL-F46RM: AUTO(*)/24-105
MR OFF	Calling up pre-registered settings	OFF(*)/MR1/MR2
±0.0	Flash compensation setting	-3.0 - +3.0
1/1	Flash power level setting	HVL-F60RM/HVL-F60RM2: 1/1 - 1/256, OFF, CMD LINK HVL-F46RM: 1/1 - 1/128, CMD LINK
5Hz	Flash frequency setting for MULTI flash mode	1 - 100
10 TIMES	Flash count setting for MULTI flash mode	2 - 100, --

Setting items	Descriptions	Setting options
	CMD flash setting (radio control) CTRL flash setting (optical control) (HVL-F60RM)	ON(*)/OFF
RATIO CONTROL: OFF	Lighting ratio setting	ON/OFF(*)
ABC	Flash power level ratio setting	OFF/1(*) - 16
RC/REMOTE: OFF	Receiver remote setting	ON/OFF(*)
GROUP: A	Wireless group setting	HVL-F60RM: OFF/A(*)/B/C/D/E(radio control) RMT(*)/RMT2(optical control) HVL-F60RM2/HVL-F46RM: OFF/A(*)/B/C/D/E(radio control)

* Factory default setting

Note

- The items and options available for setting vary depending on the flash mode.

Flash
HVL-F60RM/HVL-F60RM2/HVL-F46RM

Using the MENU screen

You can press the MENU button on the flash unit to change the settings on the MENU screen. Move the focus to the setting item of your choice with the direction buttons, and then press the center button to select the item.

1 Press the MENU button.

2 Move the focus to the setting item of your choice with the direction buttons, and then press the center button.

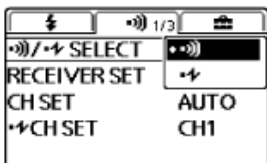

3 Change the setting option with the direction buttons and press the center button.

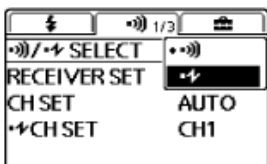

On the MENU screen, you can the following setting options.

Groups	Setting items	Descriptions	Setting options
⚡	FLASH DISTRIBUT.	Flash distribution setting	STD(*)/CENTER/EVEN
	CHG PRIORITY (HVL-F60RM2/HVL-F46RM (flash unit software version 2.00 or later))	Flash charge Priority	NORMAL(*)/STABLE
	LIGHT MODE (HVL-F60RM)	LED light ON/OFF setting	-
	MEMORY	Registration of the desired modes and settings	MR1/MR2
	AF LED LEVEL (HVL-F60RM)	AF illuminator level setting	HIGH/LOW(*)
	⚡ CHARGE SET (HVL-F60RM/HVL-F60RM2)	Flash charge-up setting when the External Battery Adaptor is connected	EXT.+INT.(*)/EXT.
	TEST	Test-flash setting	GROUP/1TIME(*)/3TIMES/4SEC
	TTL LEVEL MEMORY (HVL-F60RM/HVL-F60RM2)	TTL level memory setting	ON(*)/OFF
	LEVEL STEP	Step of flash power level setting	0.3EV(*)/0.5EV
	CUSTOM KEY	Custom key settings	-

Groups	Setting items	Descriptions	Setting options
	 /  SELECT (HVL-F60RM)	Wireless control type setting	 (*) / 
	RECEIVER SET	Receiver settings	-
	CH SET	Channel setting (radio control)	AUTO(*)/CH1 - CH14
	 CH SET (HVL-F60RM)	Channel setting (optical control)	CH1(*) - CH4
	REMOTE RELEASE (HVL-F60RM/HVL-F60RM2)	Remote release mode setting	ON/OFF(*)
	 WITH RELEASE (HVL-F60RM/HVL-F60RM2)	Remote release sync flash setting	ON/OFF(*)
	PAIRING	Pairing	-
	PAIRED DEVICE	List of the paired devices	-
	WL READY LAMP (HVL-F60RM)	Wireless flash ready lamp setting	ON/OFF(*)
	BACKLIGHT	LCD backlight setting	HVL-F60RM: AUTO1(*)/AUTO2/ON/OFF HVL-F60RM2/HVL-F46RM: AUTO(*)/ON/OFF
	 BEEP (HVL-F60RM/HVL-F60RM2)	Beep sound setting	ON/OFF(*)
	m/ft	Flash range unit setting	m(*)/ft
	POWER SAVE	Power-saving timer setting	30SEC/3MIN(*)/30MIN/OFF
	WL POWER SAVE	Wireless flash power-saving timer setting	60MIN(*)/240MIN/OFF
	VERSION	Displays the version for this product's / RCV software	-
	RESET	Resets settings for the Quick Navi screen	-
	INITIALIZE	Restores settings to their defaults	-

* Factory default setting

Flash
HVL-F60RM/HVL-F60RM2/HVL-F46RM

Direct setting (HVL-F60RM/HVL-F60RM2)

You can directly modify the flash compensation and the flash power level simply by pressing the LEVEL +/- button (Ⓢ).

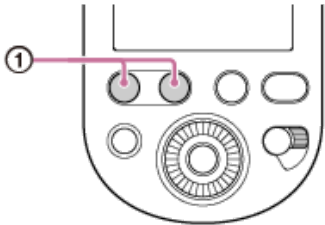

Hint

- If you assign “+/- POS SELECT” to a button of your choice, you can select a wireless group simply with the button when you use the LEVEL +/- button to modify the flash compensation or the flash power level for the group that you use, for example, for multiple wireless flash photography.

Related Topic

- [Customizing the button assignment <CUSTOM KEY>](#)

Flash
HVL-F60RM/HVL-F60RM2/HVL-F46RM

On-screen indicators (HVL-F60RM/HVL-F60RM2)

The following screen images are given as examples and may look different from what you actually see on the LCD panel.

TTL flash mode

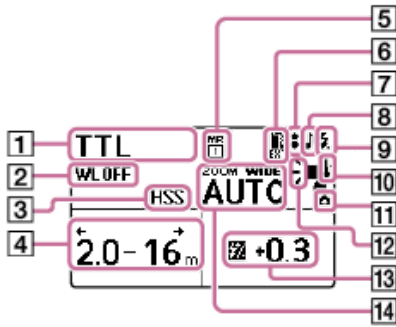

1. Flash mode
2. Wireless mode (HVL-F60RM2)
3. High-speed sync setting
4. Flash range
5. Memory Recall
6. External Battery Adaptor state
7. Bounce flash
8. Beep sound setting
9. Ready to fire
10. Internal temperature state
11. Attached to camera
12. Flash distribution setting
13. Flash compensation
14. Flash coverage (zoom)

MANUAL flash mode

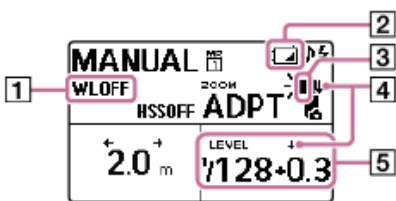

1. Wireless mode (HVL-F60RM2)
2. Low-battery indicator
3. Bounce adaptor
4. Low flash power level indicator (HVL-F60RM2 (flash unit software version 2.00 or later))

5. Flash power level

MULTI flash mode

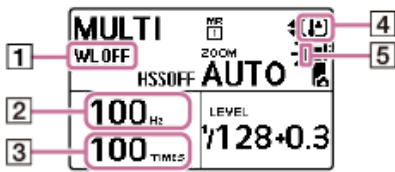

1. Wireless mode (HVL-F60RM2)
2. Flash frequency in MULTI flash mode
3. Flash count in MULTI flash mode
4. Overheat indicator
5. Color filter

Wireless commander mode (radio control)

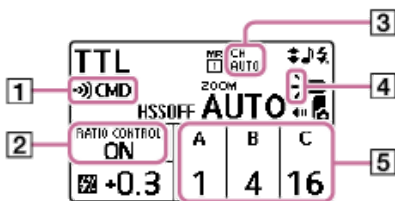

1. Wireless mode
2. Lighting ratio control setting
3. Wireless channel
4. Flash distribution setting
Commander/Control unit flash setting (HVL-F60RM)
Commander unit flash setting (HVL-F60RM2)
5. Lighting ratio

Wireless receiver mode (radio control)

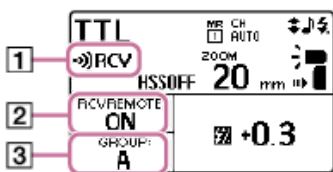

1. Wireless mode
2. Receiver remote setting
3. Wireless group setting

Wireless controller mode (optical wireless communications) (HVL-F60RM)

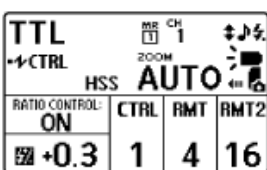

Wireless remote mode (optical wireless communications) (HVL-F60RM)

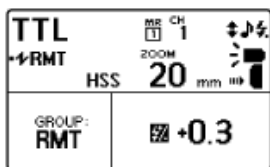

4-735-263-14(1) Copyright 2018 Sony Corporation

Flash
HVL-F60RM/HVL-F60RM2/HVL-F46RM

On-screen indicators (HVL-F46RM)

The following screen images are given as examples and may look different from what you actually see on the LCD panel.

TTL flash mode

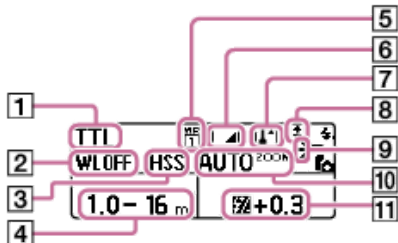

1. Flash mode
2. Wireless mode
3. High-speed sync setting
4. Flash range
5. Memory Recall
6. Low-battery indicator
7. Overheat indicator
8. Bounce flash
9. Flash distribution setting
10. Flash coverage (zoom)
11. Flash compensation

MANUAL flash mode

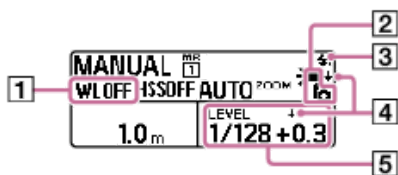

1. Wireless mode
2. Attached to camera
3. Ready to fire
4. Low flash power level indicator (flash unit software version 2.00 or later)
5. Flash power level

MULTI flash mode

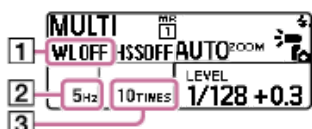

1. Wireless mode
2. Flash frequency in MULTI flash mode
3. Flash count in MULTI flash mode

Wireless commander mode (radio control)



1. Wireless mode
2. Lighting ratio control setting
3. Wireless channel
4. Flash distribution setting/Commander unit flash setting
5. Lighting ratio

Wireless receiver mode (radio control)

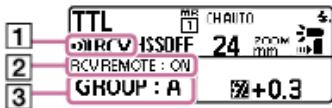

1. Wireless mode
2. Receiver remote setting
3. Wireless group setting

Flash
HVL-F60RM/HVL-F60RM2/HVL-F46RM

Unpacking

If you find anything missing, please contact your dealer.
The number in the parentheses indicates the quantity.

- Flash unit (1)
- Connector protect cap (attached) (1)
- Dust and moisture resistant cover (attached) (1) (HVL-F60RM2/HVL-F46RM)
- Mini-stand (1)
- Case (1)
- Bounce adaptor (1) (HVL-F60RM/HVL-F60RM2)
- Color filter (amber) (1) (HVL-F60RM/HVL-F60RM2)
- Color filter (green) (1) (HVL-F60RM/HVL-F60RM2)
- Pouch (1) (HVL-F60RM/HVL-F60RM2)
- Set of printed documentation

Flash
HVL-F60RM/HVL-F60RM2/HVL-F46RM

Inserting batteries

This flash unit can accommodate either set of the following:

- Four AA-size alkaline batteries
- Four AA-size rechargeable nickel-metal hydride (Ni-MH) batteries

Before you use the rechargeable nickel-metal hydride batteries, be sure to fully charge the batteries with the specified battery charger. Do not use lithium-ion batteries in this flash unit as they may prevent the flash unit from delivering full performance. No batteries are supplied with this flash unit.

- 1 HVL-F60RM/HVL-F60RM2:** Press and hold the release button (①), and then slide the battery chamber door to open in the direction of the arrows (② and ③).
HVL-F46RM: Slide open the battery chamber door (① and ②).

- HVL-F60RM/HVL-F60RM2

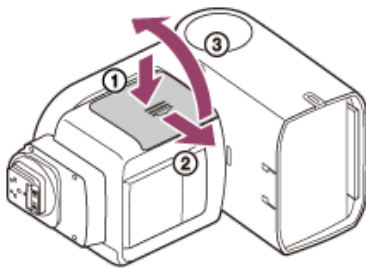

- HVL-F46RM

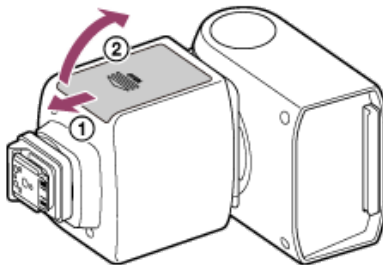

- 2** Insert the batteries into the battery chamber as illustrated (⊕ ⊖). (⊕ ⊖ indicate the direction of the batteries.)

- HVL-F60RM/HVL-F60RM2

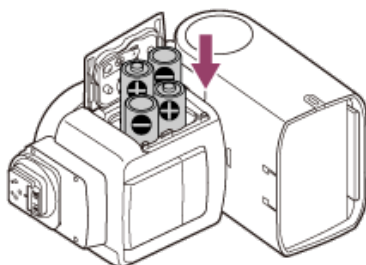

- HVL-F46RM

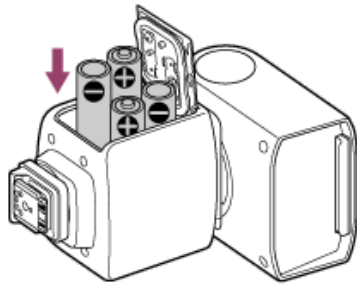

3 Close the battery chamber door.

Perform the step 1 operations in reverse order.

Flash
HVL-F60RM/HVL-F60RM2/HVL-F46RM

Attaching/removing the flash unit to/from the camera

Note

- The illustrations used in this topic are of the HVL-F60RM flash unit.

To attach the flash unit to the camera

- 1 Turn off the power to the flash unit.

If your camera is equipped with a built-in flash, make sure that the camera flash is not released.

- 2 Press and hold the release button and rotate the lock lever away from "LOCK."

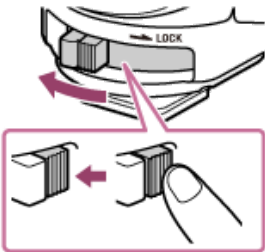

- 3 Remove the terminal protection cap from the flash unit; and the shoe cap from the camera.

- 4 Insert the Multi Interface foot of the flash unit into the Multi Interface shoe on the camera and push in the foot all the way.

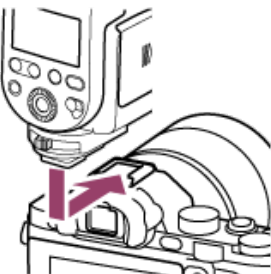

- 5 Rotate the lock lever toward "LOCK" to secure the flash unit on the camera.

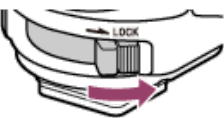

To remove the flash unit from the camera

Turn off the power of the flash unit first. Press and hold the release button, rotate the lock lever away from "LOCK," and then slide the unit out of the Multi Interface shoe.

Note

- When you do not intend to use the flash unit, be sure to attach the terminal protection cap back to the Multi Interface foot.

Flash
HVL-F60RM/HVL-F60RM2/HVL-F46RM

Attaching and removing the mini-stand

When you have removed the flash unit from the camera to place and use it alone for wireless flash photography, attach the supplied mini-stand to the unit.

Note

- The illustrations used in this topic are of the HVL-F60RM flash unit.

To attach the mini-stand

- 1 Press and hold the release button and rotate the lock lever away from “LOCK.”

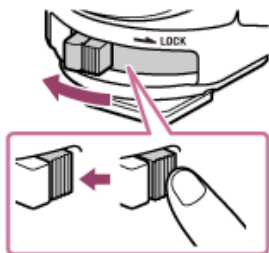

- 2 Remove the terminal protection cap from the flash unit.

- 3 Slide the mini-stand onto the Multi Interface foot of the flash unit and push in the stand all the way.

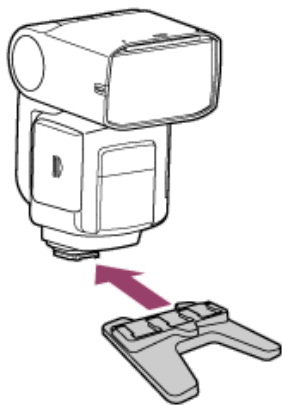

- 4 Rotate the lock lever toward “LOCK” to secure the flash unit on the camera.

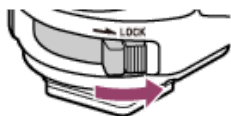

To remove the mini-stand

Press and hold the release button, rotate the lock lever away from “LOCK,” and then slide the mini-stand in the opposite direction of the arrow illustrated in step 3 for attaching the mini-stand.

Hint

- HVL-F60RM/HVL-F60RM2:
The mini-stand has 3 shoes on it. By selecting the shoe appropriate for the orientation or tilt angle of the flashlamp, you can still perform bounce flash photography while the flash unit is attached to the mini-stand.
To attach the mini-stand to this flash unit with the flashlamp tilted sideways to the right, slide the left shoe on the mini-stand onto the Multi Interface foot of the flash unit as illustrated below. When the flashlamp is tilted sideways to the left, use the right shoe.

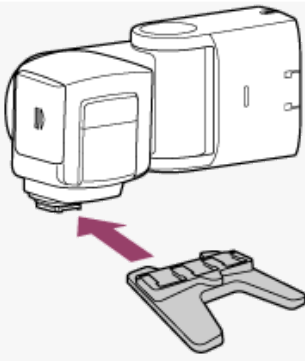

- You can screw the mini-stand to a tripod through the screw hole on the mini-stand. Use a tripod with the screw that is shorter than 5.5 mm (7/32 in.) in length. To a tripod with the longer screw, you cannot secure the mini-stand firmly with the screw, resulting in possible damage to the mini-stand.

Note

- When you do not intend to use the flash unit, be sure to attach the terminal protection cap back to the Multi Interface foot.
- HVL-F60RM2/HVL-F46RM: While rotating the lock lever toward "LOCK," you may feel resistance at some point. Keep rotating the lever in such a case as well until the flash unit is secured on the mini-stand.

Flash
HVL-F60RM/HVL-F60RM2/HVL-F46RM

Removing/attaching the dust and moisture resistant cover (HVL-F60RM2/HVL-F46RM)

Depending on the external design of a camera, the dust and moisture resistant cover attached to this flash unit may come in contact with the camera body, but you can still attach the flash unit to the camera and use it for photography.

To secure the effect of dust and moisture resistance, make sure you attach the cover properly to the flash unit by following these steps.

Note

- The illustrations used in this topic are of the HVL-F60RM2 flash unit.

To remove the dust and moisture resistant cover

Push down a corner of the dust and moisture resistant cover to take it off of the Multi Interface foot.

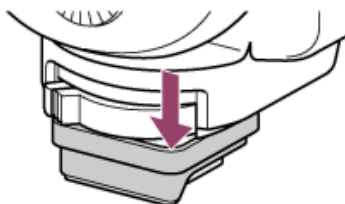

To attach the dust and moisture resistant cover

- 1 Press and hold the release button and rotate the lock lever away from "LOCK."

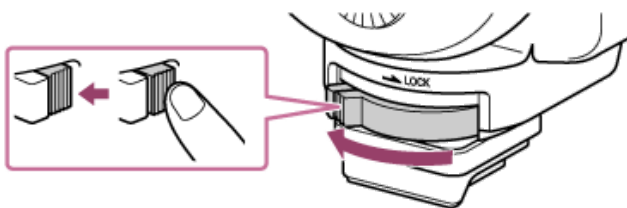

- 2 Orient the dust and moisture resistant cover with respect to the Multi Interface foot of the flash unit.

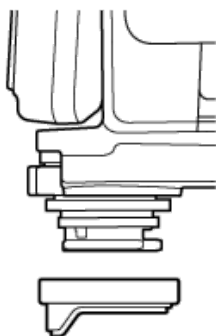

- 3 Attach the dust and moisture resistant cover by tucking its four inner corners into the gap above the Multi Interface foot.

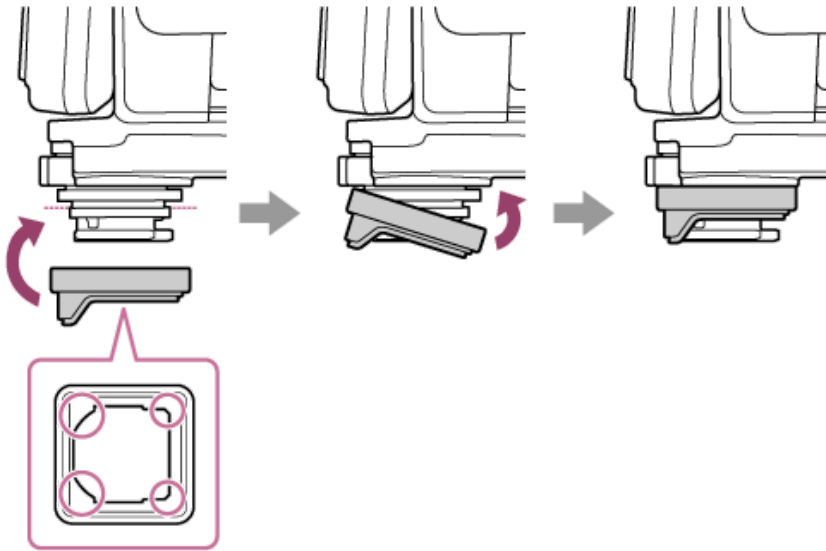

4 Make sure that the dust and moisture resistant cover is not distorted and there is no gap between the cover and the flash unit.

Tug each of the four corners of the cover to make sure it is firmly in place.
If the attached cover is distorted, remove and attach it back on.

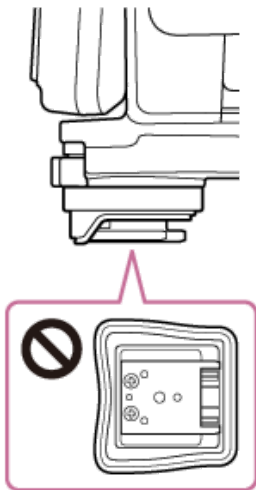

Flash
HVL-F60RM/HVL-F60RM2/HVL-F46RM

Turning on the power to the flash unit (HVL-F60RM/HVL-F60RM2)

1 Turn the power switch to ON.

When the flash unit is powered, on-screen indicators are displayed on the LCD panel.

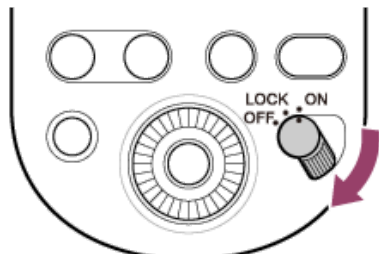

To turn off the power to the flash unit

Turn the power switch to OFF.

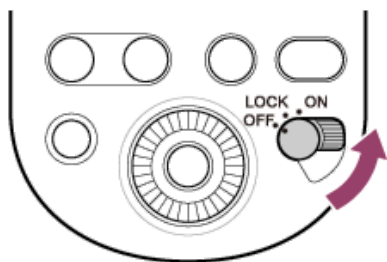

Flash charge-up

When you turn on the power to this flash unit, the flash unit starts charging up itself.

- When the flash unit is fully charged up, the TEST button on the back of the flash unit lights in orange. In addition, by selecting [ON] for [BEEP] on the MENU screen, you can set up the flash unit to beep when it is fully charged up.
- When [CHG PRIORITY] is set to [STABLE] on the MENU screen, charging time is longer than when set to [NORMAL], but a more stable firing is possible. (HVL-F60RM2 (flash unit software version 2.00 or later))

Power-saving mode

If the flash unit is left unused for 3 minutes or longer while it is used alone or connected to the camera in a power-saving state, the LCD panel will automatically turn off to conserve the battery power.

- During wireless flash photography with the flash unit used as an off-camera flash unit, the flash unit goes into power-saving mode in 60 minutes.
- Turning off the power switch on the connected camera (except for DSLR-A100) automatically places the flash unit in power-saving mode.
- You can press the MENU button and select [POWER SAVE] to specify the power-saving timer or select [WL POWER SAVE] to specify the power-saving timer for wireless flash photography.

Checking the remaining battery power

- When the batteries are running out of power, the low-battery indicator is displayed on the LCD panel as a warning.



– When  is blinking:

The batteries are running out of power. It is recommended that you replace the batteries. The flash unit, however, is still capable of firing in this state.

- When nothing but  is on the LCD panel:

The flash unit is not capable of firing. Replace the batteries.

- HVL-F60RM2: When the batteries are running out of power, not only does a warning for the battery power appear on the LCD panel, but the TEST button on the back of this flash unit flashes in orange. The illustration used below is of the HVL-F60RM2 flash unit.

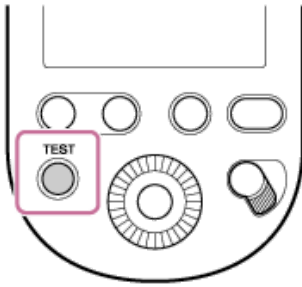

- When flashing slowly



The batteries are running out of power. It is recommended that you replace the batteries.

The flash unit, however, is still capable of firing flashes in this state.

- When flashing quickly

The flash unit is not capable of firing flashes. Replace the batteries.

Notes on continuous flashes

- If this flash unit fires in succession for a short period of time, its built-in safety circuit will be triggered to limit flash firing. On the LCD panel,  /  is displayed and the flash interval may be forced to extend. In addition, if the temperature inside the flash unit rises further,  (overheat indicator) will light on the LCD panel to indicate that flash firing is disabled for a while. In such a case, turn off the power switch on the flash unit and leave the flash unit unused for about 20 minutes to let it cool down.
- Continuous flashes heat up the batteries inside the flash unit. Take extra care when you remove the batteries.

Related Topic

- [Warning indications](#)

Flash
HVL-F60RM/HVL-F60RM2/HVL-F46RM

Turning on the power to the flash unit (HVL-F46RM)

1 Turn the power switch to ON.

When the flash unit is powered, on-screen indicators are displayed on the LCD panel.

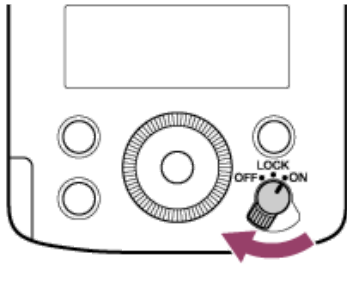

To turn off the power to the flash unit

Turn the power switch to OFF.

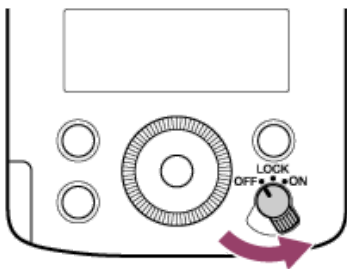

Flash charge-up

When you turn on the power to this flash unit, the flash unit starts charging up itself.

- When the flash unit is fully charged up, the TEST button on the back of the flash unit lights in orange.
- When [CHG PRIORITY] is set to [STABLE] on the MENU screen, charging time is longer than when set to [NORMAL], but a more stable firing is possible. (flash unit software version 2.00 or later)

Power-saving mode

If the flash unit is left unused for 3 minutes or longer while it is used alone or connected to the camera in a power-saving state, the LCD panel will automatically turn off to conserve the battery power.

- During wireless flash photography with the flash unit used as an off-camera flash unit, the flash unit goes into power-saving mode in 60 minutes.
- Turning off the power switch on the connected camera (except for DSLR-A100) automatically places the flash unit in power-saving mode.
- You can press the MENU button and select [POWER SAVE] to specify the power-saving timer or select [WL POWER SAVE] to specify the power-saving timer for wireless flash photography.

Checking the remaining battery power

- When the batteries are running out of power, the low-battery indicator is displayed on the LCD panel as a warning.

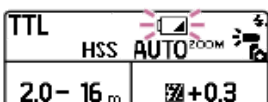

- When  is blinking:
The batteries are running out of power. It is recommended that you replace the batteries. The flash unit, however, is still capable of firing in this state.

- When nothing but  is on the LCD panel:
The flash unit is not capable of firing. Replace the batteries.
- When the batteries are running out of power, not only does a warning for the battery power appear on the LCD panel, but the TEST button on the back of this flash unit flashes in orange.

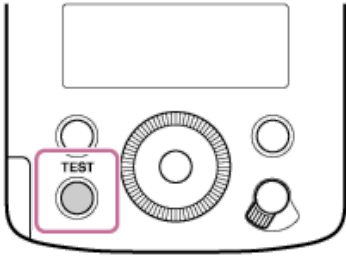

- When flashing slowly
The batteries are running out of power. It is recommended that you replace the batteries.
The flash unit, however, is still capable of firing flashes in this state.
- When flashing quickly
The flash unit is not capable of firing flashes. Replace the batteries.

Notes on continuous flashes

- If you use the flash unit continuously for a short period of time, its built-in safety circuit will be triggered to limit flash firing and the flash interval may be forced to extend.
In addition, if the temperature inside the flash unit rises further,  (overheat indicator) will light on the LCD panel to indicate that flash firing is disabled for a while. In such a case, turn off the power switch on the flash unit and leave the flash unit unused for about 10 minutes to let it cool down.
- Continuous flashes heat up the batteries inside the flash unit. Take extra care when you remove the batteries.

Related Topic

- [Warning indications](#)

Flash
HVL-F60RM/HVL-F60RM2/HVL-F46RM

Pairing with a radio wireless commander/receiver <for radio wireless flash photography>

To perform radio wireless flash photography with this flash unit, you need another flash unit that supports radio wireless communications in addition to this flash unit and must pair them both together.
For pairing this flash unit with a radio wireless commander/receiver (not supplied), refer to the operating instructions supplied with the device.

Hint

- You need to bring both devices within 1 m (3 ft. 3 3/8 in.) from each other for pairing.

1 Turn on the power to this flash unit and the other device.

2 Press the WL button (①) to display the screen for setting the wireless mode, and then specify one flash unit as the commander unit and the other as the receiver unit.

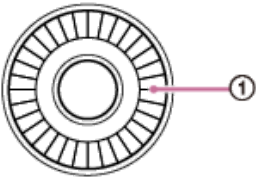

- To specify a flash unit as the commander unit, select [CMD].

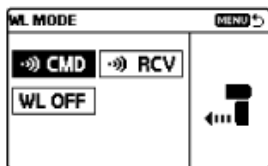

- To specify a flash unit as the receiver unit, select [RCV].

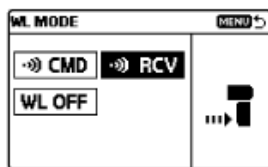

3 On this flash unit and the other flash unit, press the MENU button and select [PAIRING].



- On the commander unit, the following screen is displayed.

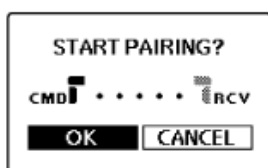

- On the receiver unit, the following screen is displayed.



4 Select [OK] to establish pairing.

- On the commander unit, the following screen is displayed.

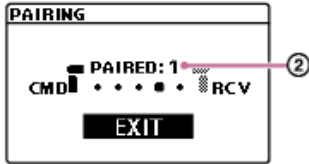

Pairing is established. On the commander unit, you can continue pairing with other receiver units. Every time pairing is established with a receiver unit, the number of paired devices (②) increases.

- On the receiver unit, the following screen is displayed.



The pairing is established.
When the pairing is established, the LINK lamp lights in green.

To establish a pairing with 2 or more devices

Set each device to be paired with this flash unit as the receiver unit and repeat steps 3 and 4.

When you are finished with pairing with all receiver units, select [EXIT] on the commander unit, and then [OK] on the following screen.

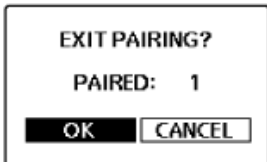

Hint

- HVL-F60RM:**
This flash unit is capable of using 2 types of wireless communications for wireless flash photography: radio and optical wireless communications. You can select the wireless type by selecting [] / [] SELECT on the MENU screen.
- You can pair the flash unit with up to 15 receiver units.
- You can view or delete the paired receiver unit(s) by selecting [PAIRED DEVICE] on the MENU screen.

Note

- The above instructions are given based on the assumption that this flash unit uses default radio wireless communications.
- When you have changed the setting of the commander unit and specified it as a receiver unit, or vice versa, be sure to reestablish pairing among the units.

Related Topic

- [Configuring the flash unit for radio wireless flash photography](#)
- [Wireless flash photography <with the receiver unit>](#)

Flash
HVL-F60RM/HVL-F60RM2/HVL-F46RM

TTL flash photography <TTL>

TTL-flash mode measures the light from the subject that is reflected through the lens. TTL metering also has a P-TTL metering function, which adds a pre-flash to TTL metering, and an ADI metering function, which adds distance data to the P-TTL metering.

Note

- ADI metering is possible in combination with a lens with a built-in distance encoder. Before using the ADI metering function, check whether your lens has a built-in distance encoder by referring to the specifications in the operating instructions supplied with your lens.

- 1 Press the **MODE** button and rotate the control wheel to select **[TTL]**.

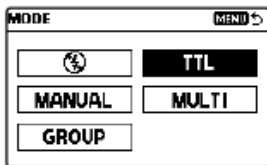

- 2 Press the shutter button to take a photo.

- When the TEST button lights in orange (ready to fire), press the shutter button on the camera.
- HVL-F60RM/HVL-F60RM2: You can press the LEVEL +/- button to change the flash compensation value (adjust the flash power level).
HVL-F46RM: You can press the +/- button to change the flash compensation (adjust the flash power level) on the screen for setting the flash compensation.
- During TTL photography, the flash range for obtaining the proper exposure with TTL compensation is displayed on the LCD panel. The flash range can be displayed in meters (m) or in feet (ft.). To change the flash range unit, use [m/ft] on the MENU screen.
[m]: Displays the flash range in meters.
[ft]: Displays the flash range in feet.
- You can specify the flash power level in steps of 0.3 EV or 0.5 EV. To change the flash power level setting step, use [LEVEL STEP] on the MENU screen.
[0.3 EV]: Changes the flash power level setting in steps of 0.3 EV.
[0.5 EV]: Changes the flash power level setting in steps of 0.5 EV.

Auto WB adjustment with color temperature information

White balance is automatically adjusted on the camera (except for DSLR-A100) based on the color temperature information at the time of flash firing.

Note

- The Auto WB adjustment function works when:
 - this flash unit is attached to the camera and placed in TTL flash mode.
 - [Auto] or [Flash] is specified for the white balance on the camera.

Notes on TTL flash photography

- Take photos within the indicated flash range.
This flash unit is capable of indicating distances within the range from 0.7 m to 28 m (2.3 ft. to 91.9 ft.). If the distance is beyond this range, **+** or **+** next to the flash range indicator will light.
- To use fill-flash or auto-flash mode of the camera, you need to select the mode on the camera.
- Before photographing with the flash unit using the self-timer of the camera, make sure that the TEST button is lit.

- If flash compensation is made both on the flash unit and the camera, both compensation values are added up for flash firing. On the LCD panel of the flash unit, however, only the compensation value specified on the unit is displayed.

Flash
HVL-F60RM/HVL-F60RM2/HVL-F46RM

Manual flash photography <MANUAL>

MANUAL flash mode keeps the flash power level consistent regardless of the brightness of the subject or the settings of the camera.

- 1 Select the M (Manual) shooting mode on the camera.
- 2 Press the MODE button and rotate the control wheel to select [MANUAL].

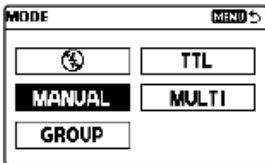

- 3 HVL-F60RM/HVL-F60RM2: Press the LEVEL +/- button to select the flash power level of your choice.
HVL-F46RM: Press the +/- button and specify the flash power level of your choice on the screen for setting the power level.

The illustration used below is of the HVL-F60RM2 flash unit.

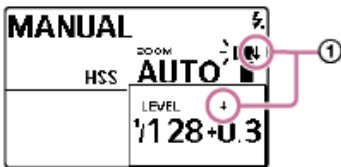

- HVL-F60RM/HVL-F60RM2: You can specify the flash power level in the range from 1/1 (brightest) to 1/256 (darkest).
HVL-F46RM: You can specify the flash power level in the range from 1/1 (brightest) to 1/128 (darkest).
- Increasing the flash power by one level (e.g. 1/1 → 1/2) is equivalent to increasing the aperture by one level (e.g. F4 → 5.6).
- HVL-F60RM2/HVL-F46RM (flash unit software version 2.00 or later): When using the flash unit in combination with a camera equipped with global shutter image sensor, the flash power level of the flash unit may not reach the set value, depending on the shutter speed setting of the camera. In such cases, a low flash power level indicator (Ⓢ) is displayed on the LCD panel of the flash unit.

In addition, a low flash power level indicator (⚡↓) is also displayed on the flash charging icon of the camera.

For the shutter speed and flash power level setting conditions under which the low flash power level indicator is displayed, see “The setting conditions under which the low flash power level indicator is displayed” below.

- 4 Press the shutter button to take a photo.

When the TEST button lights in orange (ready to fire), press the shutter button on the camera.

TTL level memory function (HVL-F60RM/HVL-F60RM2)

During TTL flash photography, a measured flash power level is automatically set as the flash power level in MANUAL flash mode. This enables you to adjust the flash power in MANUAL flash mode on the basis of the flash power level measured during TTL flash photography, and to omit a series of operations necessary for determining the flash power level.

To change the TTL level memory function setting, use [TTL LEVEL MEMORY] on the MENU screen.

Notes on using the TTL level memory function (HVL-F60RM/HVL-F60RM2)

- During multiple wireless flash photography (group flash photography), the guide number changes according to the flash settings (for example, the zoom setting) of individual flash units. To retain an appropriate flash power level, specify a different wireless group for each flash unit.
- If a flash unit that does not support the TTL level memory function is used for multiple wireless flash photography (group flash photography), an appropriate flash power level may not be retained.

- In MANUAL flash mode, the flash power level measured during TTL flash photography is only retained. If you change the settings that affect the flash power level, such as the flash power level setting or the zoom setting, after photographing, the changed settings will not be retained. When you have made such changes, perform TTL flash photography once again.
- If the flash power level measured during TTL flash photography is lower than the levels available in MANUAL flash mode, the photographed images may appear over-exposed.

The setting conditions under which the low flash power level indicator is displayed (HVL-F60RM2/HVL-F46RM (flash unit software version 2.00 or later))

- ✓ : Sufficient flash power level
 - : Insufficient flash power level

- HVL-F60RM2

Shutter speed	Flash power level setting								
	1/256	1/128	1/64	1/32	1/16	1/8	1/4	1/2	1/1
1/250	✓	✓	✓	✓	✓	✓	✓	✓	✓
1/500	✓	✓	✓	✓	✓	✓	✓	✓	-
1/1000	✓	✓	✓	✓	✓	✓	✓	✓	-
1/2000	✓	✓	✓	✓	✓	✓	✓	-	-
1/4000	✓	✓	✓	✓	✓	✓	-	-	-
1/8000	✓	✓	✓	✓	✓	-	-	-	-
1/16000	✓	✓	✓	✓	-	-	-	-	-
1/32000	✓	✓	✓	-	-	-	-	-	-
1/64000	✓	✓	-	-	-	-	-	-	-
1/80000	✓	✓	-	-	-	-	-	-	-

- HVL-F46RM

Shutter speed	Flash power level setting							
	1/128	1/64	1/32	1/16	1/8	1/4	1/2	1/1
1/250	✓	✓	✓	✓	✓	✓	✓	✓
1/500	✓	✓	✓	✓	✓	✓	✓	-
1/1000	✓	✓	✓	✓	✓	✓	✓	-
1/2000	✓	✓	✓	✓	✓	✓	-	-
1/4000	✓	✓	✓	✓	✓	-	-	-
1/8000	✓	✓	✓	✓	-	-	-	-
1/16000	✓	✓	✓	-	-	-	-	-
1/32000	✓	✓	-	-	-	-	-	-
1/64000	✓	-	-	-	-	-	-	-
1/80000	✓	-	-	-	-	-	-	-

Hint

- You can press the shutter button halfway down to display the distance for the proper exposure on the LCD panel.
- You can press the MENU button and select [LEVEL STEP] to change the flash power level setting step ([0.3EV] or [0.5EV]).

- HVL-F60RM/HVL-F60RM2: If you assign "TTL/M SWITCH" to a button of your choice, you can switch the flash mode between TTL flash mode and MANUAL flash mode simply with the button.
- HVL-F60RM2/HVL-F46RM (flash unit software version 2.00 or later): When [CHG PRIORITY] is set to [STABLE] on the MENU screen, charging time is longer than when set to [NORMAL], but a more stable firing is possible.

Related Topic

- [TTL flash photography <TTL>](#)
- [Customizing the button assignment <CUSTOM KEY>](#)

4-735-263-14(1) Copyright 2018 Sony Corporation

Flash
HVL-F60RM/HVL-F60RM2/HVL-F46RM

High-speed sync photography <HSS>

High-speed sync photography eliminates the flash sync speed restrictions and enables the flash unit to be used through the entire shutter speed range of the camera. An increase in the selectable aperture range allows flash photography with a wide aperture, leaving the background out of focus and accentuating the front subject. When photographing a scene, where the background is very bright and the photograph is likely to be over-exposed, at a wide f-stop in A or M shooting mode of the camera, you can still adjust the exposure to the proper level by using the high-speed shutter.

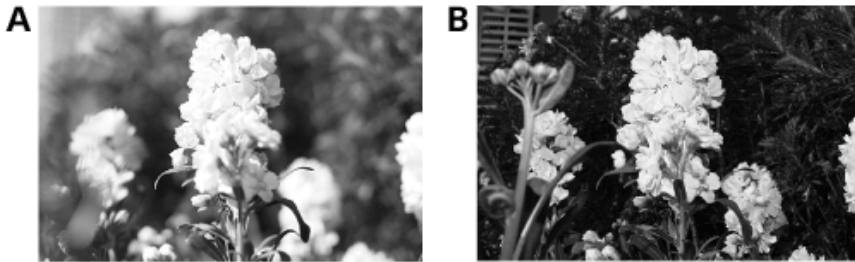

A: High-speed sync photography
B: Normal flash photography

- 1 Press the Fn button, select [HSS] on the Quick Navi screen, and then select [ON] or [OFF].

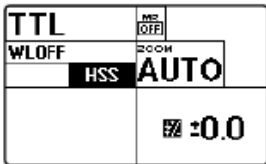

Flash sync speed

Flash photography is generally associated with the maximum shutter speed referred to as the flash sync speed. This restriction does not apply to cameras designed for high-speed sync (HSS) photography, since they allow flash photography at the maximum shutter speed of the camera.

Note

- If you set the shutter speed of the camera faster than 1/4000 and take a photo, bright and dark streaks may appear on the photo. It is recommended that you set the flash power level to at least MANUAL 1/2 for photography.
 - The minimum value available for specifying the flash power level varies in accordance with the high-speed sync setting.
 - When [ON] is selected: 1/128
 - When [OFF] is selected: 1/256*
- * For HVL-F46RM, the minimum value is limited to 1/128 when [WL OFF] is selected for wireless mode.

Flash
HVL-F60RM/HVL-F60RM2/HVL-F46RM

Global shutter sync photography (HVL-F60RM2/HVL-F46RM)

By using a combination of an HVL-F60RM2/HVL-F46RM (flash unit software version 2.00 or later) and a camera equipped with global shutter image sensor, flash photography can be synchronized with the entire range of shutter speeds available on the camera, enabling more effective flash exposures than conventional high-speed sync photography (HSS).

Note

- If you set the shutter speed of the camera faster than 1/10000 and take a photo, brightness and colors may vary.
- With a camera equipped with global shutter image sensor, the HSS icon is not displayed on the camera regardless of whether the high-speed sync setting is [ON]/[OFF].
- When the flash unit and camera are connected with an off-camera cable (not supplied) to perform photography, then instead of global shutter sync photography, it is performed by the conventional high-speed sync photography, so the distance the flash light can reach is shortened.
- During multiple flash photography or with the camera flash mode set to rear curtain sync, the shutter speed of the camera is limited to the flash sync speed.
- If the shutter speed of the camera is set faster than the flash duration of the flash unit, the flash power level of the flash unit may not reach the set value. In such cases, a low flash power level indicator is displayed on the LCD panel of the flash unit. For details, see [Manual flash photography <MANUAL>](#). In addition, for the maximum possible exposure GN conversion value depending on the shutter speed, see "Global shutter sync flash/STD flash distribution (ISO 100)" in the topic below.
 - HVL-F60RM2: [Guide number \(HVL-F60RM/HVL-F60RM2\)](#)
 - HVL-F46RM: [Guide number \(HVL-F46RM\)](#)

Flash
HVL-F60RM/HVL-F60RM2/HVL-F46RM

Multiple flash photography <MULTI>

This flash unit is capable of firing multiple times while the camera shutter is open (multiple flash photography). Multiple flash photography allows you to capture a series of movements of the subject in a single photo.

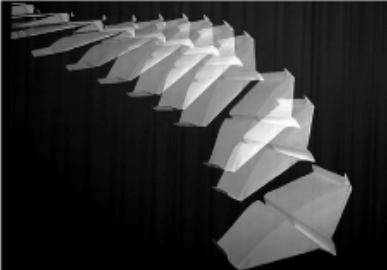

Hint

- For multiple flash photography, you need to place the camera in M shooting mode. Otherwise, you may not obtain the proper exposure.
- To avoid blurring of images due to hand movement, it is recommended that you use a tripod for multiple flash photography.

- 1 Press the **MODE** button to display the screen for setting the flash mode, and then select **[MULTI]**.

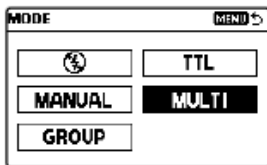

- 2 Press the **Fn** button, select one of the following setting items on the Quick Navi screen with the direction buttons, and then select a value with the control wheel.

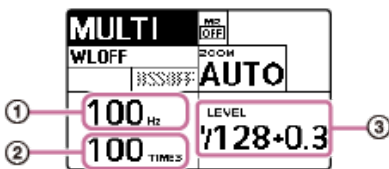

- ①: [Hz]
Description: Flash frequency in MULTI flash mode
Setting options: 1 Hz - 100 Hz
- ②: [TIMES]
Description: Flash count in MULTI flash mode
Setting options: 2 - 100, --
- ③: [LEVEL]
Description: Flash power level setting
Setting options:
HVL-F60RM/HVL-F60RM2: 1/8 - 1/256
HVL-F46RM: 1/8 - 1/128

While [--] is selected for [TIMES], the flash unit continues to fire as many times as possible with the specified frequency in multiple flash so long as the camera shutter is open.

- 3 Select the shutter speed and the aperture on the camera.

The shutter speed should be at least equal to the number selected for the flash count in MULTI flash mode (TIMES) divided by the specified frequency in multiple flash (Hz).

For example, if “10” is selected for the number for the flash count in MULTI flash mode and “5 Hz” for the frequency in multiple flash, select at least 2 seconds for the shutter speed of the camera.

4 Press the shutter button to take a photo.

When the TEST button lights in orange (ready to fire), press the shutter button on the camera.

Maximum number for the flash count in MULTI flash mode

Due to the limited battery capacity, the maximum numbers that you can specify for the flash count in MULTI flash mode are listed in the following tables as guidelines.

When using the alkaline batteries (HVL-F60RM/HVL-F60RM2)

Flash power levels	Flash frequencies (Hz)																		
	100	90	80	70	60	50	40	30	20	10	9	8	7	6	5	4	3	2	1
1/8	4	4	4	4	4	4	4	4	4	6	6	6	6	6	7	8	10	15	100*
1/16	8	8	8	8	8	8	8	8	8	10	10	10	10	15	20	25	100*	100*	100*
1/32	16	16	16	17	17	17	18	19	20	35	40	45	100*	100*	100*	100*	100*	100*	100*
1/64	30	30	30	30	30	30	35	40	50	100*	100*	100*	100*	100*	100*	100*	100*	100*	100*
1/128	50	60	60	60	65	100*	100*	100*	100*	100*	100*	100*	100*	100*	100*	100*	100*	100*	100*
1/256	100*	100*	100*	100*	100*	100*	100*	100*	100*	100*	100*	100*	100*	100*	100*	100*	100*	100*	100*

“100*” indicates 100 or greater.

When using the alkaline batteries (HVL-F46RM)

Flash power levels	Flash frequencies (Hz)																		
	100	90	80	70	60	50	40	30	20	10	9	8	7	6	5	4	3	2	1
1/8	5	5	5	5	5	5	5	5	6	6	6	6	7	7	8	9	10	100*	100*
1/16	8	8	9	9	9	9	10	10	10	15	15	20	20	30	45	65	100*	100*	100*
1/32	15	15	15	15	17	17	18	18	20	40	50	65	80	100*	100*	100*	100*	100*	100*
1/64	30	30	32	32	35	37	40	45	75	100*	100*	100*	100*	100*	100*	100*	100*	100*	100*
1/128	60	60	65	65	70	100*	100*	100*	100*	100*	100*	100*	100*	100*	100*	100*	100*	100*	100*

“100*” indicates 100 or greater.

When using the nickel-hydrate batteries (HVL-F60RM/HVL-F60RM2)

Flash power levels	Flash frequencies (Hz)																		
	100	90	80	70	60	50	40	30	20	10	9	8	7	6	5	4	3	2	1
1/8	4	4	4	4	4	4	5	5	5	7	7	7	7	10	10	15	100*	100*	100*
1/16	8	8	8	9	9	9	10	10	10	20	20	35	40	100*	100*	100*	100*	100*	100*
1/32	17	17	17	17	18	18	20	20	25	100*	100*	100*	100*	100*	100*	100*	100*	100*	100*
1/64	30	30	32	32	32	40	45	60	100*	100*	100*	100*	100*	100*	100*	100*	100*	100*	100*

Flash power levels	Flash frequencies (Hz)																		
	100	90	80	70	60	50	40	30	20	10	9	8	7	6	5	4	3	2	1
1/128	60	60	100*	100*	100*	100*	100*	100*	100*	100*	100*	100*	100*	100*	100*	100*	100*	100*	100*
1/256	100*	100*	100*	100*	100*	100*	100*	100*	100*	100*	100*	100*	100*	100*	100*	100*	100*	100*	100*

“100*” indicates 100 or greater.

When using the nickel-hydrate batteries (HVL-F46RM)

Flash power levels	Flash frequencies (Hz)																		
	100	90	80	70	60	50	40	30	20	10	9	8	7	6	5	4	3	2	1
1/8	5	5	5	5	5	5	5	6	6	7	7	8	8	10	10	25	100*	100*	100*
1/16	8	8	9	9	9	9	10	10	10	15	20	30	60	75	100*	100*	100*	100*	100*
1/32	17	17	18	18	18	19	20	20	40	80	100*	100*	100*	100*	100*	100*	100*	100*	100*
1/64	32	33	35	36	40	45	55	95	100*	100*	100*	100*	100*	100*	100*	100*	100*	100*	100*
1/128	63	65	70	100*	100*	100*	100*	100*	100*	100*	100*	100*	100*	100*	100*	100*	100*	100*	100*

“100*” indicates 100 or greater.

Note

- The maximum number that you can specify for the flash count in MULTI flash mode varies depending on the type and condition of the batteries.

Flash
HVL-F60RM/HVL-F60RM2/HVL-F46RM

Firing a test-flash

You can fire a test-flash before you start photographing. If you intend to use a flash meter for manual flash photography, be sure to fire a test-flash.

- 1 When the TEST button lights in orange (ready to fire), press the TEST button.

Tips on firing a test-flash

- The flash power for a test-flash depends on the flash power level specified for each flash mode. During TTL flash photography, this flash unit fires at the GN equivalent of 2.
- With the test-flash function, you can preview how the subject cast shadows (a modeling flash). On this flash unit, you can select [3TIMES] (3 flashes) or [4SEC] (continuous flashes at consistent intervals for 4 seconds) for a modeling flash. To change the test-flash setting on the flash unit, press the MENU button, select [TEST], and then change the setting option.
- When [1TIME] or [GROUP] is specified for the test-flash setting, you can press and hold the TEST button to fire the specified number of test flashes with the specified flash frequency and power in MULTI flash mode.
- For radio wireless photography, you can press the test-flash button on the commander unit to force the receiver unit(s) to fire in accordance with the test-flash setting on the commander unit.
- If this flash unit is specified as the commander unit for radio wireless photography, the TEST button will light in orange when all the flash units, including the receiver units, are ready to fire.

Flash
HVL-F60RM/HVL-F60RM2/HVL-F46RM

Selecting the wireless type for controlling wireless flash photography <radio or optical> (HVL-F60RM)

This flash unit is capable of using 2 types of wireless communications for wireless flash photography: radio and optical wireless communications.

Hint

- In this Help Guide, the “commander unit” refers to this flash unit that is attached to a camera or the radio wireless commander that you use for radio wireless flash photography; and the “receiver unit” refers to this flash unit that is wirelessly controlled to fire or the radio wireless receiver. On the other hand, the “controller unit” refers to this flash unit that is attached to a camera or the built-in flash of another camera that you use for optical wireless flash photography; and the “remote unit” refers to this flash unit that is wirelessly controlled to fire or the flash unit compatible with optical wireless control.

Radio wireless flash photography

Wireless flash photography is available using the radio communication method. This helps you photograph with the flash unit in an environment with many obstacles.

For radio wireless flash photography, you need another flash unit or a wireless commander/receiver (not supplied) that supports radio wireless communications in addition to this flash unit.



Note

- For radio wireless flash photography, you need the camera that supports radio wireless communications. Refer to the operating instructions supplied with the camera. For camera models compatible with the flash unit, visit the website at: <https://www.sony.net/flash/f60rm/>

Optical wireless flash photography



Wireless flash photography is available using the optical communication method. This helps you photograph with the flash unit in an environment where radio communications are not available.

For optical wireless flash photography, you need another flash unit that supports optical wireless communications in addition to this flash unit.

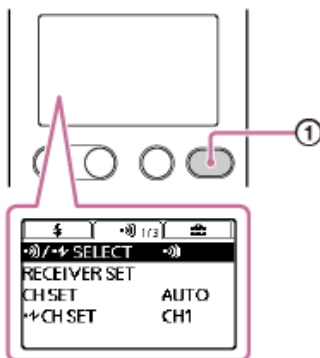
- 1 Press the MENU button (①) and select [] / [] SELECT].



- 2 Select the wireless communication method of your choice.

-  : Radio wireless communications with the flash unit
-  : Optical wireless communications with the flash unit

Related Topic

- [Configuring the flash unit for radio wireless flash photography](#)
- [Configuring the flash unit for optical wireless flash photography \(HVL-F60RM\)](#)

Flash
HVL-F60RM/HVL-F60RM2/HVL-F46RM

Configuring the flash unit for radio wireless flash photography

This flash unit supports radio wireless communications for flash photography. Specify [CMD] for the commander unit attached to the camera; and [RCV] for the receiver unit (off-camera flash unit) of which flash operation is wirelessly triggered. On the camera, select the wireless (WL) flash mode.

Hint

- To perform radio wireless flash photography, you need to establish pairing between the commander unit and the receiver unit(s) in advance.

1 Press the WL button (1) on this flash unit and select [CMD] for the commander unit; and [RCV] for the receiver unit.

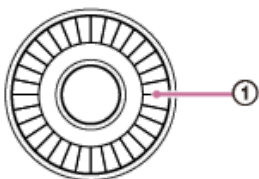

- To specify the flash unit as the commander unit, select [CMD].

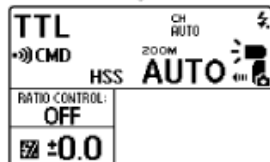
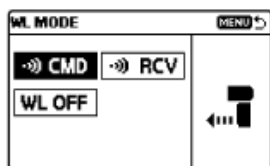

- To specify the flash unit as the receiver unit, select [RCV].

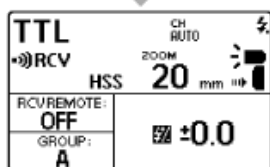
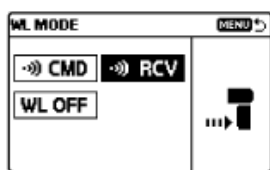

Hint

- The radio wireless communication distance available between the commander unit and the receiver unit is approximately 30 m (98.4 ft.). (Acquired under our measurement conditions.)
- On the commander unit, press the MENU button, select [CH SET], and then specify the channel to be used for radio wireless communications. While [AUTO] is selected for [CH SET], a channel appropriate for the radio conditions at the time that you turn on the flash unit is used.
- When this flash unit is ready to fire,  is displayed on the LCD panel. If this flash unit is specified as the commander unit, the TEST button will light in orange when all the flash units, including the receiver units, are ready to fire.

Related Topic

- [Pairing with a radio wireless commander/receiver <for radio wireless flash photography>](#)
- [Selecting the wireless type for controlling wireless flash photography <radio or optical> \(HVL-F60RM\)](#)

4-735-263-14(1) Copyright 2018 Sony Corporation

Flash
HVL-F60RM/HVL-F60RM2/HVL-F46RM

Wireless flash photography <with the receiver unit>

You can specify either of the following devices as the commander unit, and then use the commander unit to trigger the flash operation of this flash unit placed away from the camera.

- another flash unit that is attached to the camera and supports radio wireless communications
- the radio wireless commander that is attached to the camera

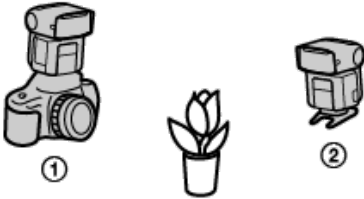

①: Commander unit (CMD)

②: HVL-F60RM/HVL-F60RM2/HVL-F46RM (RCV)

As the commander unit, you can use this flash unit or a radio wireless commander.

- 1 Select the wireless (WL) flash mode on the camera.**
For selecting the flash mode on the camera, refer to the operating instructions supplied with the camera.
- 2 Press the WL button on this flash unit and select [RCV].**
- 3 Press the Fn button and specify the wireless group of this flash unit for wireless group selection on the Quick Navi screen.**
- 4 Attach the mini-stand to this flash unit.**
- 5 Attach another flash unit of the same model or a radio wireless commander specified as the commander unit ([CMD] is selected) to the camera.**
Make sure that [CMD] is displayed on the LCD panel of the commander unit.
- 6 Place the camera and this flash unit.**
- 7 Make sure that the flash unit on the camera (commander unit) and this flash unit (receiver unit) are wirelessly connected and ready to fire.**
 - Wirelessly connected:
The LINK lamp is lit in green.
 - Ready to fire:
 - The TEST button on the back of this flash unit is lit in orange.
 - HVL-F60RM: While [ON] is selected for [WL READY LAMP] on the MENU screen, the AF illuminator on the front of the receiver unit blinks.
- 8 Press the shutter button to take a photo.**
To fire a test-flash, press the TEST button on the commander unit.

- On the receiver units, the flash mode of the commander unit is applied.
- During manual flash photography, you can enable adjustment on the commander unit by selecting [CMD LINK] for the flash power level setting on the Quick Navi screen.

Related Topic

- [Pairing with a radio wireless commander/receiver <for radio wireless flash photography>](#)
- [Selecting the wireless type for controlling wireless flash photography <radio or optical> \(HVL-F60RM\)](#)
- [Attaching and removing the mini-stand](#)

4-735-263-14(1) Copyright 2018 Sony Corporation

Flash
HVL-F60RM/HVL-F60RM2/HVL-F46RM

Multiple radio wireless flash photography with flash power level ratio control

You can perform wireless flash photography while controlling the lighting ratio among a maximum of 3 wireless groups (A, B, and C) of flash units including the commander unit. Before you perform multiple wireless flash photography, be sure to specify the flash unit as the commander unit or the receiver unit.

- Commander unit: HVL-F60RM/HVL-F60RM2/HVL-F46RM or a radio wireless commander
- Receiver unit (off-camera flash unit): HVL-F60RM/HVL-F60RM2/HVL-F46RM or a radio wireless receiver

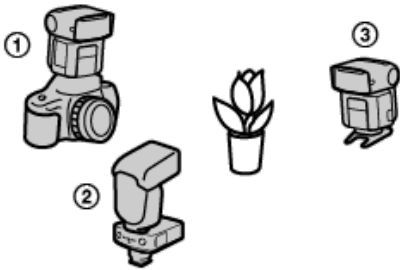

- ①: Commander unit (CMD)
②: Wireless receiver
③: Receiver unit (RCV)

- 1 Press the Fn button on the commander unit, select [RATIO CONTROL] on the Quick Navi screen, and then select [ON].
- 2 Press the Fn button on the commander unit, select the wireless group (A/B/C) for which you want to change the flash power level ratio on the Quick Navi screen, and then specify the ratio.

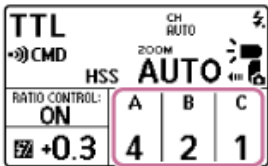

As shown above, when the flash power level ratio for TTL flash photography is displayed as [4:2:1] on the LCD panel, the flash unit in each group fires with a fraction of the total flash power: 4/7, 2/7, and 1/7, respectively.

Hint

- The commander unit fires as a member of the wireless group A. If you do not want the commander unit to fire, select  (CMD flash setting) on the Quick Navi screen and select [OFF].

Related Topic

- [Pairing with a radio wireless commander/receiver <for radio wireless flash photography>](#)
- [Selecting the wireless type for controlling wireless flash photography <radio or optical> \(HVL-F60RM\)](#)

Flash
HVL-F60RM/HVL-F60RM2/HVL-F46RM

Multiple wireless flash photography <group flash photography>

You can perform wireless flash photography among a maximum of 5 wireless groups of flash units including the commander unit. Before you perform multiple wireless flash photography, be sure to specify the flash unit as the commander unit or the receiver unit.

- Commander unit: HVL-F60RM/HVL-F60RM2/HVL-F46RM or a radio wireless commander
- Receiver unit (off-camera flash unit): HVL-F60RM/HVL-F60RM2/HVL-F46RM or a wireless receiver

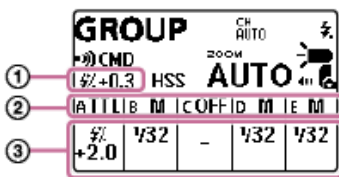

1 Press the **MODE** button and select **[GROUP]** on the screen for flash mode selection.

2 Specify the flash mode, the flash compensation, and the flash power level for the wireless groups A, B, C, D, and E on the Quick Navi screen for **GROUP** flash mode setting.



1. Collective flash compensation (HVL-F60RM/HVL-F60RM2)
2. Flash mode setting
3. Flash compensation/flash power level setting

Hint

- You can specify [TTL], [MANUAL], or [OFF] for the flash mode of the wireless groups A, B, and C. For the wireless groups D and E, on the other hand, you can specify either [MANUAL] or [OFF]. The flash units in the wireless group with the flash mode specified as [OFF] do not fire.
- HVL-F60RM/HVL-F60RM2: While [ON] is selected for [TTL LEVEL MEMORY] (TTL level memory function), the flash power level measured during TTL flash photography is automatically used as the flash power level for each wireless group (A/B/C) during manual flash photography.
- The commander unit fires as a member of the wireless group A. If you do not want the commander unit to fire, select  (CMD flash setting) on the Quick Navi screen and select [OFF].
- HVL-F60RM/HVL-F60RM2: You can specify a collective flash compensation level to make the flash compensation/flash power level setting for all the groups.
- HVL-F60RM2/HVL-F46RM (flash unit software version 2.00 or later):  (low flash power level indicator) is displayed if the group includes even one flash unit whose flash power level may not be sufficient. If this happens, correct the flash power level of all the flash units in the group or set the shutter speed of the camera to a lower speed.



Related Topic

- [Pairing with a radio wireless commander/receiver <for radio wireless flash photography>](#)
- [Selecting the wireless type for controlling wireless flash photography <radio or optical> \(HVL-F60RM\)](#)

Flash
HVL-F60RM/HVL-F60RM2/HVL-F46RM

Remote release photography (HVL-F60RM/HVL-F60RM2)

When this flash unit (the commander unit) is attached to a camera and its remote release mode setting is specified as [ON], releasing the shutter on the camera sends control signals to another flash unit of the same model (the receiver unit) that is connected to another camera with the Multi Terminal Connecting Cable, VMC-MM1 (not supplied). This releases the shutter on the other camera at the same time.



- ①: HVL-F60RM/HVL-F60RM2 (CMD)
②: Another HVL-F60RM/HVL-F60RM2 (RCV)

- 1 Press the WL button on this flash unit and select [CMD].
- 2 Press the MENU button (①) on the commander unit, select [REMOTE RELEASE], and then select [ON].

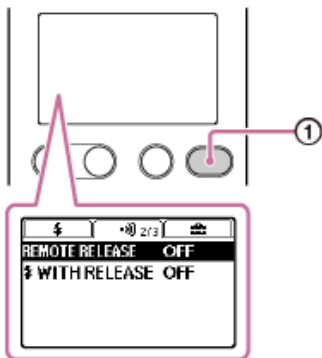

The remote release mode setting on the receiver unit will be enabled automatically.

- 3 Connect another camera to the Multi/Micro USB terminal on another flash unit of the same model specified as the receiver unit ([RCV] is selected) with the Multi Terminal Connecting Cable.

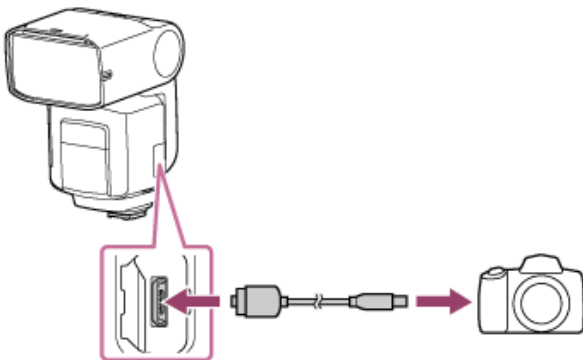

- 4 Release the shutter on the camera with the commander unit attached.

The shutter on the other camera connected with the receiver unit is released at the same time.

Remote release sync flash function

With the remote release sync flash function, you can control the commander and receiver units to fire in synchronization with the release of the camera shutter.

To use the function, select the wireless (WL) flash mode on the camera and select [ON] for [ WITH RELEASE] on the MENU screen on this flash unit. While [ON] is selected, you can change the flash mode of this flash unit.

For selecting the flash mode on the camera, refer to the operating instructions supplied with the camera.

Notes on remote release photography

- Both the commander unit and the receiver unit must support remote release photography.
- To perform remote release photography, you need to connect this flash unit specified as the receiver unit to a camera with the Multi Terminal Connecting Cable.
- To use the remote release sync flash function on this flash unit specified as the receiver unit, you need to change the setting option for [ WITH RELEASE] to [ON] on the MENU screen on the receiver unit and attach the receiver unit to the camera with the clip-on connection.
- The shutter release timing depends on the settings of an individual camera. In addition, the shutter release of the camera with the receiver unit connected lags behind the shutter release of the camera with the commander unit attached.
- On the camera with the receiver unit connected, it is recommended that you select the manual focus mode for the camera or the lens and adjust the focus manually. If the auto focus fails on the camera, the release of the shutter may also fail.
- If you use the remote release sync flash function to control multiple flash units to fire at the same time, it may result in improper exposure or uneven brightness of the photographed image.

Hint

- You can release the shutter of the camera with the receiver unit connected by pressing the center button on the flash unit specified as the commander unit.

Related Topic

- [Pairing with a radio wireless commander/receiver <for radio wireless flash photography>](#)
- [Selecting the wireless type for controlling wireless flash photography <radio or optical> \(HVL-F60RM\)](#)

Flash
HVL-F60RM/HVL-F60RM2/HVL-F46RM

Changing the settings of individual receiver units <RECEIVER SET>

When you perform multiple flash photography, for example, you can change the wireless group setting and the zoom setting of individual paired receiver units on the MENU screen on the commander unit.

Note

- To enable the commander unit to change the settings of individual receiver units, you need to enable [RCV REMOTE] on each receiver unit in advance. Press the Fn button on the receiver unit, select [RCV REMOTE] on the Quick Navi screen, and then select [ON].

- 1 Press the MENU button on the commander unit and select [RECEIVER SET].

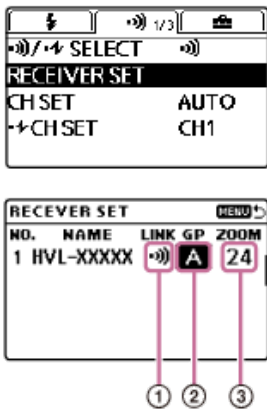

1. Wireless connection status

2. Wireless group setting

You can select [A], [B], [C], [D], [E], or [OFF].

3. Zoom setting

You can change the zoom setting for the receiver unit.

Note

- When the value selected for the zoom setting on the commander unit is larger or smaller than the zoom setting values available on the receiver unit, the maximum or minimum value is selected for the zoom setting on the receiver unit.

Flash

HVL-F60RM/HVL-F60RM2/HVL-F46RM

Notes on radio wireless flash photography

- During photography with off-camera flash units, P-TTL flash metering is automatically used instead of ADI metering.
- HVL-F60RM2/HVL-F46RM (flash unit software version 2.00 or later): When you use both a global shutter sync photography compatible flash unit and non-compatible flash unit for multiple radio wireless flash photography with flash power level ratio control or group flash photography, global shutter sync photography is not possible. It will be high-speed sync photography instead.
If you want to perform global shutter sync photography during multiple flash photography, make sure that all the flash units you use are compatible with global shutter sync photography.

Flash
HVL-F60RM/HVL-F60RM2/HVL-F46RM

Configuring the flash unit for optical wireless flash photography (HVL-F60RM)

This flash unit supports optical wireless communications for flash photography. Specify [CTRL] for the flash unit attached to the camera as the controller unit; and [RMT] for the off-camera flash unit of which flash operation is wirelessly triggered as the remote unit.

- 1 Press the WL button (①) and select [CTRL] for the controller unit; and [RMT] for the remote unit.

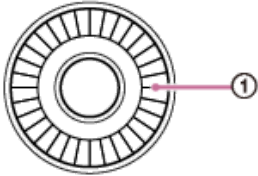

- To specify the flash unit as the controller unit, select [CTRL].

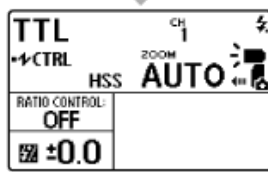
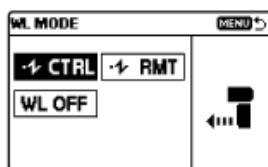

- To specify the flash unit as the remote unit, select [RMT].

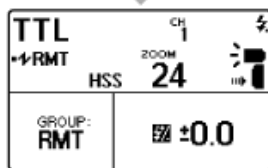
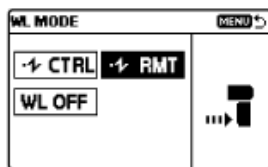

Hint

- Place the controller and remote units within a 5 m (16.4 ft.) radius of the subject.

Related Topic

- [Selecting the wireless type for controlling wireless flash photography <radio or optical> \(HVL-F60RM\)](#)

Flash
HVL-F60RM/HVL-F60RM2/HVL-F46RM

Wireless flash photography <with the remote unit> (HVL-F60RM)

You can specify another flash unit attached to the camera or the built-in flash of the camera as the controller unit, and then use the controller unit to trigger the flash operation of this flash unit placed away from the camera.

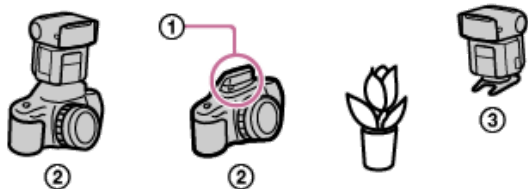

- ①: Built-in flash
- ②: Controller unit (CTRL)
- ③: HVL-F60RM (RMT)

As the controller unit, you can use the built-in flash of an A-mount camera or another flash unit model (HVL-F20M, HVL-F32M, HVL-F43M, HVL-F45RM, HVL-F60M, etc.) available for a separate purchase.

Note

- Before you use the built-in flash of the camera as the controller unit, be sure to:
 - Attach this flash unit to the camera and turn on the power to the flash unit and the camera.
 - Select the wireless channel of your choice for [ CH SET] on the MENU screen on this flash unit.

1 Select the wireless (WL) flash mode on the camera.

For selecting the flash mode on the camera, refer to the operating instructions supplied with the camera.

2 Remove this flash unit from the camera and attach the mini-stand to the flash unit.

3 Release the built-in flash of the camera or attach another flash unit to the camera.

- Make sure that [RMT] is displayed on the LCD panel of this flash unit. If [CTRL] is displayed, press the WL button and change the setting option to [RMT].
- Make sure that the flash unit attached to the camera is specified as the controller unit. For details, refer to the operating instructions supplied with the attached flash unit.

4 Place the camera and this flash unit.

5 Make sure that the built-in flash of the camera (controller unit) and this flash unit are ready to fire.

When this flash unit is ready to fire, the TEST button on the back of the flash unit lights in orange. In addition, while [ON] is selected for [WL READY LAMP] on the MENU screen, the AF illuminator on the front of the remote unit blinks.

6 Press the shutter button to take a photo.

For firing a test-flash with the camera flash, refer to the operating instructions supplied with the camera.

Note

- If this flash unit does not fire, change the locations of the camera, this flash unit, and the subject; or point the wireless control signal receiver of this flash unit toward the camera.

Related Topic

- [Selecting the wireless type for controlling wireless flash photography <radio or optical> \(HVL-F60RM\)](#)
- [Attaching/removing the flash unit to/from the camera](#)
- [Attaching and removing the mini-stand](#)

4-735-263-14(1) Copyright 2018 Sony Corporation

Flash
HVL-F60RM/HVL-F60RM2/HVL-F46RM

Multiple optical wireless flash photography with flash power level ratio control (HVL-F60RM)

You can perform wireless flash photography while controlling the lighting ratio among a maximum of 3 wireless groups (CTRL, RMT, and RMT2) of flash units including the controller unit. Before you perform multiple wireless flash photography, be sure to specify the flash unit as the controller unit or the remote unit.

- Controller unit: HVL-F60RM
- Remote unit (off-camera flash unit): HVL-F60RM or another flash unit model that supports optical wireless communications

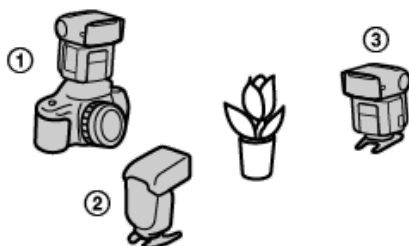

- ①: Controller unit (CTRL)
②: Remote unit (RMT)
③: Remote unit (RMT2)

- 1 Press the Fn button on the controller unit, select [RATIO CONTROL] on the Quick Navi screen, and then select [ON].
- 2 Press the Fn button on the controller unit, select the wireless group (CTRL/RMT/RMT2) for which you want to change the flash power level ratio on the Quick Navi screen, and then specify the ratio.

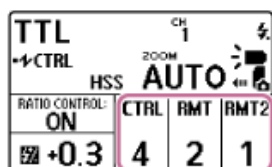

As shown above, when the flash power level ratio for TTL flash photography is displayed as [4:2:1] on the LCD panel, the flash unit in each group fires with a fraction of the total flash power: 4/7, 2/7, and 1/7, respectively.

Hint

- You can set the remote units (off-camera flash units) into 2 wireless groups (RMT and RMT2). On each remote unit, press the Fn button, select the setting item for wireless group selection for this flash unit on the Quick Navi screen, and then change the group.
- If you do not want the controller unit to fire, press the Fn button on the controller unit, select  (CMD flash setting) on the Quick Navi screen, and then select [OFF].
- When the controller unit is in MANUAL flash mode, it fires with the flash power specified on the controller unit.
- When the remote unit is in MANUAL flash mode, it fires with the flash power specified on the remote unit.

Related Topic

- [Selecting the wireless type for controlling wireless flash photography <radio or optical> \(HVL-F60RM\)](#)

Flash
HVL-F60RM/HVL-F60RM2/HVL-F46RM

Notes on optical wireless flash photography (HVL-F60RM)

- During wireless flash photography, measurement with a flash meter or a color meter is not available because of the pre-flash of the flash unit.
- When [AUTO] is selected for the flash coverage (zoom) of this flash unit specified as the remote unit, the flash coverage is automatically set to 20 mm.
- During photography with off-camera flash units, P-TTL flash metering is automatically used instead of ADI metering.
- You can concurrently use multiple remote units (off-camera flash units).
- When the remote units (off-camera flash units) are in MANUAL flash mode, individual units fire with the flash power specified on each unit.
- All flash units used for wireless flash photography must share the same wireless channel (CH). On this flash unit, you can specify the wireless channel by pressing the MENU button and selecting [ CH SET].
- Consecutively firing multiple times (multiple flash photography) is not available during optical wireless flash photography.

Flash
HVL-F60RM/HVL-F60RM2/HVL-F46RM

Using the sync terminal for flash photography (HVL-F60RM/HVL-F60RM2)

You can connect another flash unit or camera to this flash unit with the sync cord (not supplied) to perform synchronized flash photography as described below.

- When a flash unit with the sync terminal (not supplied) is connected to this flash unit that is attached to a camera, the connected flash unit fires in synchronization with the camera.
- When a flash unit with the sync terminal is connected to this flash unit that is specified as the receiver/remote unit, the connected flash unit fires in synchronization with the signals from the commander/controller unit.
- When a camera is connected to this flash unit, this flash unit fires in synchronization with the connected camera.

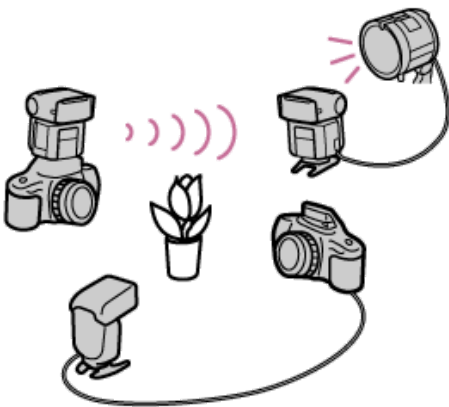

Note

- Before connecting the sync cord, make sure that the flash unit to be connected to this flash unit is powered off. If the flash unit is powered, connecting the sync cord may cause the flash unit to fire.
- With this flash unit, do not use any commercially available flash units with:
 - over 250 V
 - reversed polarity

- 1 Connect a flash unit with the sync terminal to the sync terminal (①) on this flash unit using a sync cord.

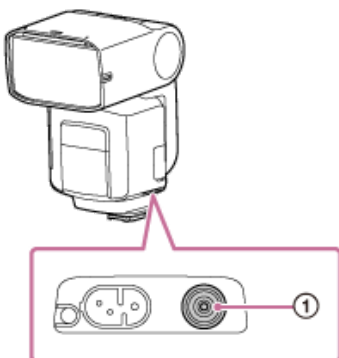

Note

- When a flash unit with the sync terminal is connected to this flash unit with the sync cord, this flash unit may automatically be powered off if the period of photography exceeds the power-saving timer period selected on this flash unit. In such a case, change the power-saving timer setting to [OFF] on the MENU screen.
- During high-speed sync photography (HSS) with this flash unit attached to a camera, the flash unit with the sync terminal connected to this flash unit does not fire in synchronization with the shutter button operations on the camera.

- When you use the flash unit connected to the sync terminal on this flash unit, set the shutter speed of the camera to the slower one of the following two or to a slower speed slower than either one.
 - the synch speed of the camera
 - the shutter speed recommended on the flash unit

4-735-263-14(1) Copyright 2018 Sony Corporation

Flash
HVL-F60RM/HVL-F60RM2/HVL-F46RM

Using the LED light for video shooting (HVL-F60RM)

You can use the LED light of this flash unit as a light source for video shooting. It helps create natural lights and shadows in an environment with poor lighting, such as indoors, to add more 3D effects to video.

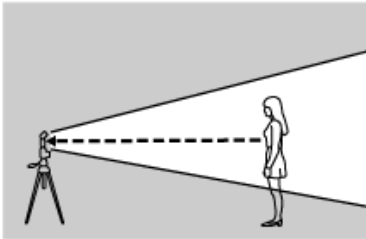

- 1 Press the MENU button (①) and select [LIGHT MODE].

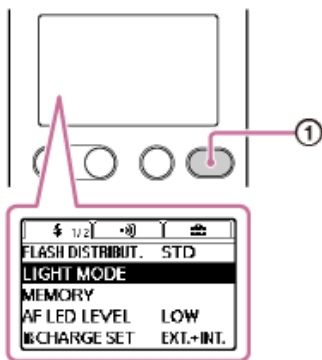

- 2 Press the center button to turn on the LED light.

To turn it off, press the center button once again.

- 3 Adjust LED brightness with the control wheel.

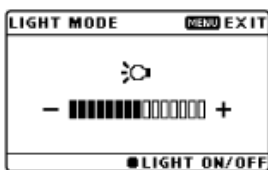

To finish video shooting with the LED light, press the MENU button.

Note

- While the LED light on the flash unit is lit, the flash mode indicator (⚡) is not displayed on the camera (i.e. the camera flash is disabled).
- Depending on the camera, lens, and brightness settings for video shooting, the proper white balance may not be obtained. In such a case, adjust the balance on the camera.
- Depending on the size of the lens attached to the camera, the LED beam may be obstructed by the lens end.

Flash
HVL-F60RM/HVL-F60RM2/HVL-F46RM

Selecting the flash coverage automatically <auto zoom>

This flash unit automatically selects the appropriate flash coverage for the focal length of the lens on the attached camera within the range from 20 mm to 200 mm (HVL-F60RM/HVL-F60RM2) or the range from 24 mm to 105 mm (HVL-F46RM) (auto zoom). You do not need to manually select the flash coverage most of the time.

1 Press the Fn button, select [ZOOM] on the Quick Navi screen, and then select [AUTO].

When [AUTO] is displayed as the flash coverage (zoom) setting on the LCD panel, the auto zoom function is enabled.

If you use a lens with the focal length of less than 20 mm (in combination with HVL-F60RM/HVL-F60RM2) or 24 mm (in combination with HVL-F46RM) while the auto zoom function is enabled, [WIDE] will blink on the LCD panel.



In such a case, proceed to the rest of the steps.

2 Gently pull out the wide panel along with the bounce sheet and fold down the wide panel to cover the flashlamp.

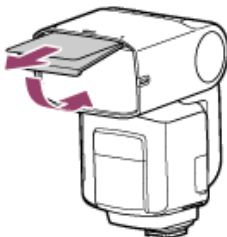

3 Push the bounce sheet back into the flash unit.

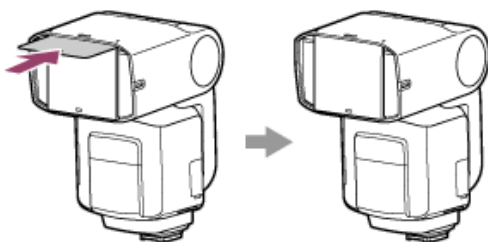

[WIDE] is displayed on the LCD panel.

Flash distribution setting

You can specify the flash distribution pattern by selecting [FLASH DISTRIBUT.] on the MENU screen. The flash distribution setting is applied to the flash coverage whether it is selected automatically or manually.

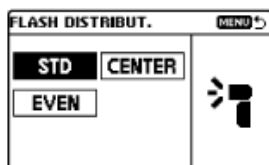

- STD: Flash coverage with standard flash distribution
- CENTER: Flash coverage with priority given to guide numbers

- EVEN: 

Flash coverage with priority given to wider periphery

Note

- When you retract the wide panel, push it back all the way into the flash unit and make sure that [WIDE] is not displayed on the LCD panel.
- When you pull out the built-in wide panel, do not apply excessive force as it may cause damage to the wide panel.
- When you photograph the 2D subject from its front using a lens with the focal length of less than 18 mm, the periphery of the screen may appear slightly darker because of the difference in intensity of the flash light at the center and periphery of the screen.
- When you use a wide-angle lens with the focal length of less than 14 mm (in combination with HVL-F60RM/HVL-F60RM2) or 15 mm (in combination with HVL-F46RM), the periphery of the screen may appear darker.
- The focal length displayed on the LCD panel indicates the equivalent 35mm-format focal length.
- This flash unit does not support the angle of view of a 16mm F2.8 Fisheye lens.
- Before storing this flash unit in the supplied case, be sure to push the wide panel and the bounce sheet back into the unit.
- Depending on the focal length specified for photography, the periphery of the screen may appear darker. In such a case, change the flash distribution pattern.

Related Topic

- [Selecting the flash coverage manually <manual zoom>](#)

4-735-263-14(1) Copyright 2018 Sony Corporation

Flash
HVL-F60RM/HVL-F60RM2/HVL-F46RM

Selecting the flash coverage manually <manual zoom>

You can manually select the flash coverage of the flash unit regardless of the focal length of the lens in use (manual zoom).

- 1 Press the ZOOM button and select the flash coverage with the control wheel.

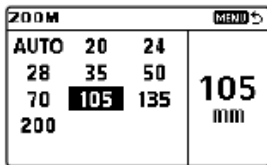

Note

- Depending on the focal length specified for photography, the periphery of the screen may appear darker. In such a case, change the flash distribution pattern.

Related Topic

- [Selecting the flash coverage automatically <auto zoom>](#)

Flash
HVL-F60RM/HVL-F60RM2/HVL-F46RM

Bounce flash photography

Using the flash unit with a wall directly behind the subject produces strong shadows on the wall. By directing the flash unit at the ceiling you can illuminate the subject with reflected light, reducing the intensity of the shadows and producing a softer light on the screen.

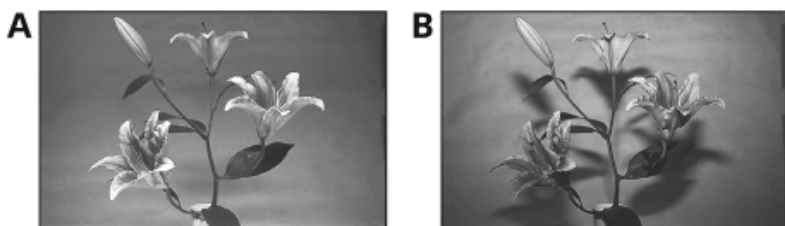
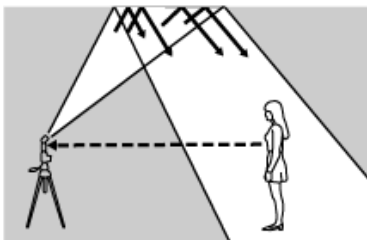

A: Bounce flash photography
B: Standard flash photography

1 Hold the camera firmly and tilt up/down the flashlamp, tilt it to the left/right, or swivel it to the left/right.

On the LCD panel,  is displayed to indicate bounce flash photography.

- Tilting up/down (Side view of HVL-F60RM/HVL-F60RM2/HVL-F46RM)

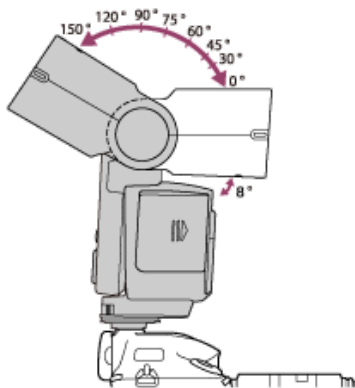

- Tilting to the left/right (Front view of HVL-F60RM/HVL-F60RM2)

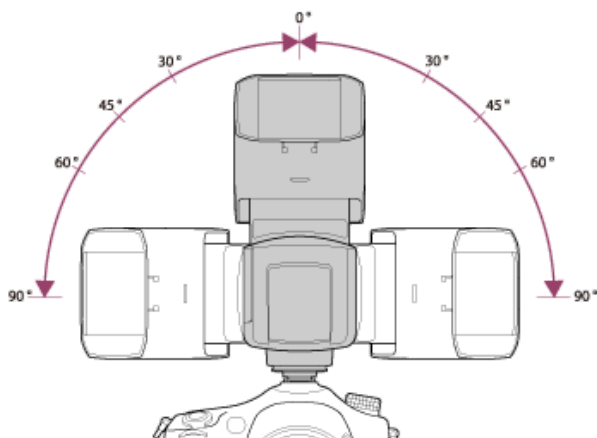

- Swiveling to the left/right (Top view of HVL-F46RM)

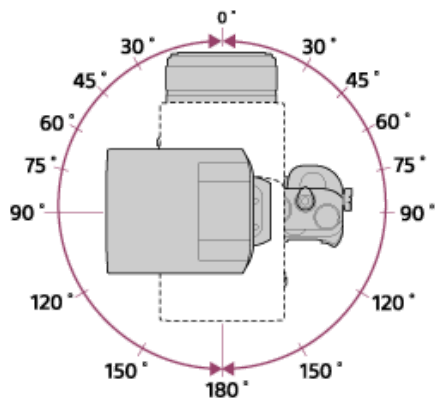

Note

- When the flashlamp is tilted up, the flash range is not displayed on the LCD panel.
- Use a white ceiling or wall to bounce the flash light. A colored surface may tint the bounced light. High ceilings or glass are not recommended for the bounce surface.

Flash
HVL-F60RM/HVL-F60RM2/HVL-F46RM

Adjusting the bounce flash angle

Simultaneous use of the flash light from this flash unit and the bounced light produces uneven lighting. To determine the bounce flash angle, take the flash photography conditions into consideration, such as the distance to the bounce surface, the distance from the camera to the subject, and the focal length of the lens.

Examples of flash photography conditions: the distance to the bounce surface, the distance from the camera to the subject, the focal length of the lens

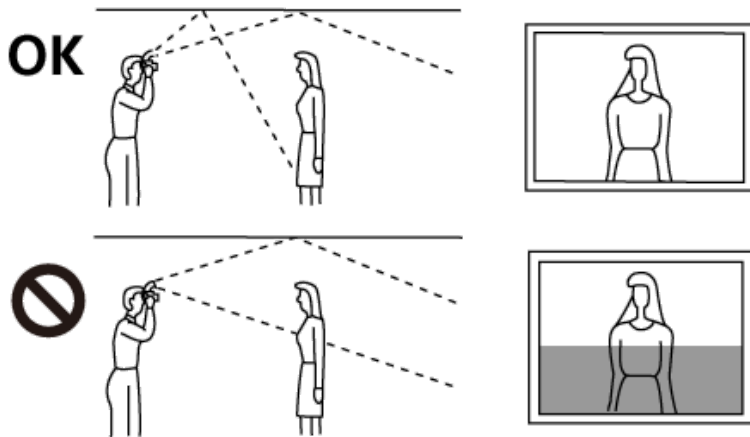

To bounce the flash light upward

Determine the bounce flash angle with consideration for the focal lengths of the lens listed in the following table.

Focal lengths of the lens	Bounce angle
70 mm minimum	30 °, 45 °
28 mm - 70 mm	60 °
28 mm maximum	75 °, 90 °

Tips on using the bounce sheet

The bounce sheet creates a highlight in the subject's eyes and makes the subject look more vibrant. The bounce sheet is pulled out along with the wide panel from this flash unit. Push the wide panel back into the flash unit.

Hint

- When you use the bounce sheet for flash photography, tilt up the flashlamp by 90 °.

Flash
HVL-F60RM/HVL-F60RM2/HVL-F46RM

Using the quick shift bounce function (HVL-F60RM/HVL-F60RM2)

When you perform bounce flash photography with the camera placed in the portrait orientation, you can use the quick shift bounce function to reproduce the bounced light consistent with the one produced during photography with the camera placed in the landscape orientation. In addition, you can use the operation console in the proper orientation as well.

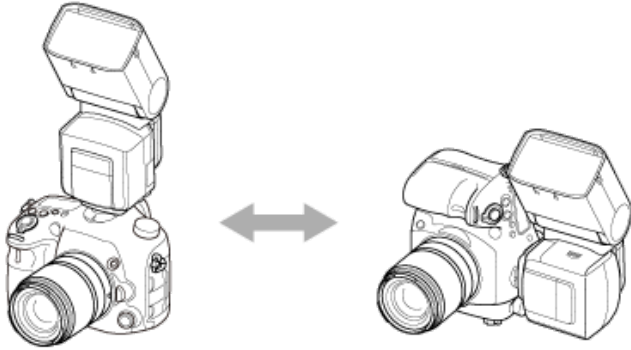

90 ° sideways bounce flash photography

When the flashlamp is tilted sideways by 90 ° in either direction for flash photography and the camera is placed in the portrait orientation, the top and bottom of the photographed images may appear darker. In such a case, use the built-in wide panel or tilt the flashlamp back to the upright position.

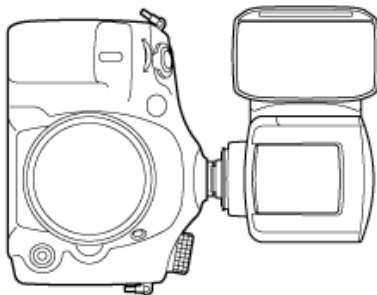

On the LCD panel,  is displayed to indicate bounce flash photography.

Note

- When [AUTO] is selected for the flash coverage (zoom) of this flash unit, the coverage is adjusted automatically to the wide angle during 90 ° sideways bounce flash photography. In such a case, the flash range may be reduced compared to the one available for bounce flash photography with the flashlamp tilted back to the upright position.

Flash
HVL-F60RM/HVL-F60RM2/HVL-F46RM

Using the bounce adaptor (HVL-F60RM/HVL-F60RM2)

With the supplied bounce adaptor attached to the flashlamp for bounce flash photography, you can diffuse the light from the flash unit over a wider range, producing a softer light and reducing shadows.

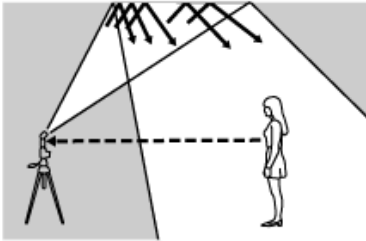

To attach the bounce adaptor

- 1 Align the tabs on the bounce adaptor with the grooves on the flash unit and push in the bounce adaptor in the direction of the arrow.

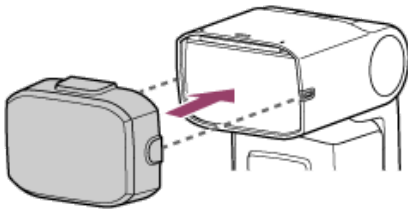

When the bounce adaptor is properly attached,  is displayed on the LCD panel.

Notes on attaching the bounce adaptor

As illustrated below, hold the bounce adaptor with its elongated part fit over the flashlamp top, make sure its orientation with the flashlamp is right, and then push in the adaptor all the way. Insufficient attachment may prevent accurate compensation.

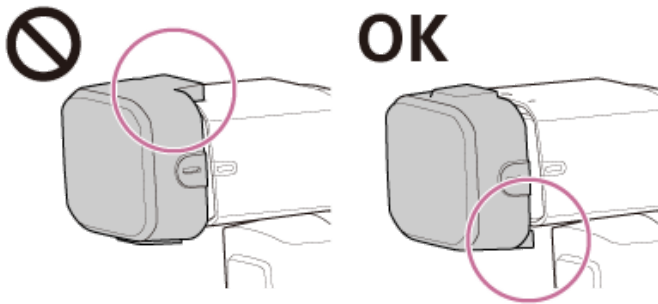

To remove the bounce adaptor

While pulling the tab on the bounce adaptor in the direction of the arrow (①), pull out the bounce adaptor in the direction of the arrow (②).

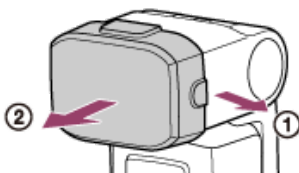

Flash
HVL-F60RM/HVL-F60RM2/HVL-F46RM

Close-up flash photography <downward bounce flash photography>

When the object is located 0.7 - 1.0 m (2.3 ft. - 3 ft. 3 3/8 in.) away from the camera, you can tilt the flashlamp slightly downward for flash photography to ensure accurate illumination.

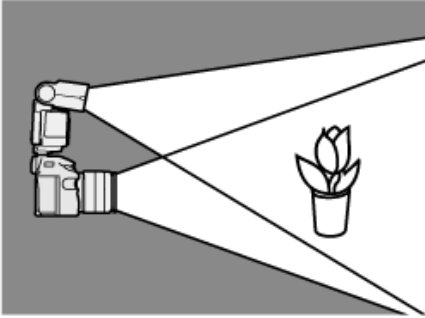

- 1 Hold the camera firmly and tilt down the flashlamp.

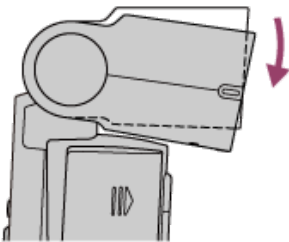

On the LCD panel,  is displayed to indicate bounce flash photography.
The downward tilt angle is up to -8°.

Note

- When you photograph the subject located closer than 0.7 m (2.3 ft.) from the camera, the bottom of the photographed images may appear darker because the flashlamp is not capable of tilting down sufficiently enough to illuminate the subject. For close-up photography, it is recommended that you use an off-camera flash unit, a macro twin flash unit (not supplied), or a ring light (not supplied).
- HVL-F60RM/HVL-F60RM2: You can tilt down the flashlamp only when it is in the upright position or tilted sideways by 90° in either direction.
- When the physically long lens is used, the flash light may be obstructed by the lens end.

Flash
HVL-F60RM/HVL-F60RM2/HVL-F46RM

Tips on the AF illuminator (HVL-F60RM)

If the brightness or contrast setting of the camera is not sufficient for photographing the subject, the AF illuminator (LED light) on the front of the flash unit may light when you press the shutter button halfway down for auto-focusing. The AF illuminator is provided for aiding auto-focusing.

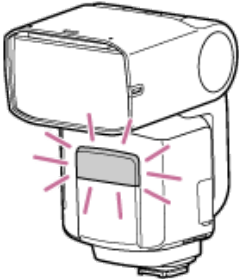

- The AF illuminator operates even when  is displayed on the LCD panel.
- When you want to change the brightness of the AF illuminator, press the MENU button, select [AF LED LEVEL], and then select [HIGH] or [LOW].
- To disable the AF illuminator, use the menu on the camera to turn it off.
- When the AF illuminator on the flash unit lights, the AF illuminator on the camera is disabled.
- While the camera is in Continuous AF mode (the camera is focusing on a moving subject), the AF illuminator does not light.
- If the focal length of the lens is greater than 300 mm, the AF illuminator may not light. In addition, when the flash unit is removed from the camera, the AF illuminator does not light.
- Depending on the camera to which the flash unit is attached, the AF illuminator may not light.

Flash
HVL-F60RM/HVL-F60RM2/HVL-F46RM

Using color filters (HVL-F60RM/HVL-F60RM2)

Depending on the ambient light during photography, the sufficient flash light may not reach the background of the subject and the photographed images may appear in unnatural colors. With the supplied color filters used for photography, the photographed images appear in natural colors.

- Amber color filter: for photography under the light of light bulbs
- Green color filter: for photography under the light of fluorescent bulbs

Note

- When a color filter is used, the ambient conditions and others may affect the colors of the photographed images. In such a case, adjust the white balance on the camera to obtain the colors of your choice.

To attach the color filter

- 1 Align the elongated part (①) of the color filter with the dented part (②) on the flashlamp top.

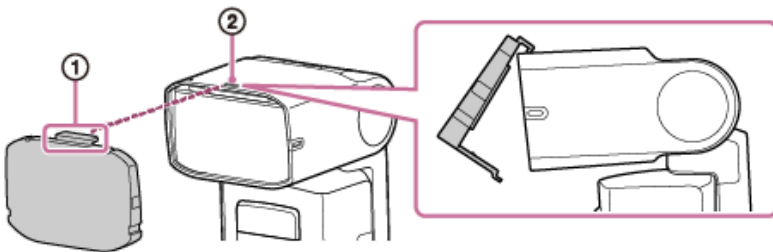

- 2 Push in the color filter in the direction of the arrow until it clicks into place.

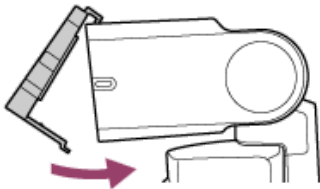

When the color filter is properly attached,  is displayed on the LCD panel.

To remove the color filter

Tilt up the flashlamp, put the fingertip onto the elongated part (①) of the color filter, and then pull up the filter in the direction of the arrow.

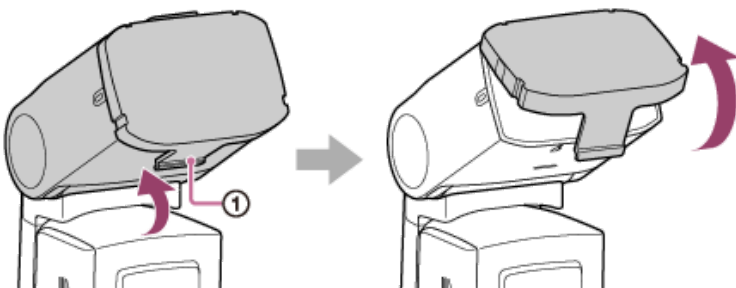

Note

- When a color filter is used, the Auto WB adjustment function of the camera works in the following cases. However, it does not work for multiple flash photography when a color filter is used.
 - This flash unit is attached to the camera with the clip-on connection and placed in TTL flash mode.

— [Auto] or [Flash] is specified for the white balance on the camera.

4-735-263-14(1) Copyright 2018 Sony Corporation

Flash
HVL-F60RM/HVL-F60RM2/HVL-F46RM

Connecting an external power source (HVL-F60RM/HVL-F60RM2)

With the External Battery Adaptor (not supplied) connected to the DC IN terminal on this flash unit, this flash unit can fire continuous flashes with shorter flash charge-up time.

For details, refer to the operating instructions supplied with the External Battery Adaptor.



To change the flash charge-up setting, use [ CHARGE SET] on the MENU screen.

Menu item details



EXT.+INT.:

Uses the power from the batteries in this flash unit and in the External Battery Adaptor for flash photography to reduce the flash charge-up time. (factory default setting)

EXT.:

Uses the power only from the batteries in the External Battery Adaptor for flash photography. There is no need to concern the remaining power of the batteries in this unit. On the LCD panel,  is displayed. When the batteries in the External Battery Adaptor are running out of power, blinking  is displayed and the power from the batteries in this flash unit is used for flash photography as well.

Note

- The power from the batteries in the External Battery Adaptor is used only for the flash unit to charge up itself. For the flash unit to be powered, it needs batteries in its battery chamber.
- If [EXT.] is selected and the batteries in the connected External Battery Adaptor are running out of power, it will take longer for the flash unit to charge up itself for flash photography.
- When the batteries in the connected External Battery Adaptor are worn out and  on the LCD panel is blinking, replacing the batteries does not turn off . It remains on the LCD panel until you perform flash photography once.
- When FA-EB1AM is in use, you cannot use [EXT.].

Flash
HVL-F60RM/HVL-F60RM2/HVL-F46RM

Registering/calling up a preference <MEMORY>

You can register the mode or a set of values that you frequently use to either [MR1] or [MR2] as a preference and call it up simply by selecting its name.

To register a preference

- 1 Set up this flash unit as you want for registering as a preference.
- 2 Press the MENU button and select [MEMORY].

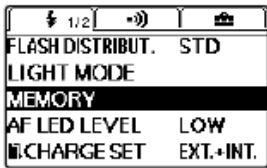

- 3 Select the preference name of your choice ([MR1] or [MR2]).

To call up a preference

Press the Fn button, select the setting item for preferences call-up, and then select the preference name of your choice ([MR1] or [MR2]).

Hint

- To change the preference properties, call up a preference, change the setups of this flash unit, and then register the setups with [MEMORY] on the MENU screen once again.
- When you do not intend to use the registered preferences, select [OFF] in the procedure for registering the preference.

Note

- While the preference is in effect, [RESET] on the MENU screen is disabled.

Flash
HVL-F60RM/HVL-F60RM2/HVL-F46RM

Customizing the button assignment <CUSTOM KEY>

You can assign a function of your choice to some of the controls on the operation console: the direction buttons, the center button, and the control wheel.

- 1 Press the MENU button and select [CUSTOM KEY].



- 2 Select the control of your choice with the direction buttons.

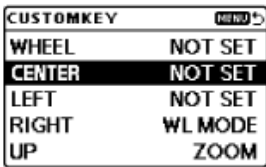

- 3 Select the function that you want to assign with the direction buttons.

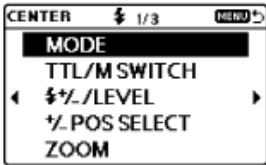

The following lists the functions and the controls available for assignment.

Groups	Assignable functions	Descriptions	Controls available for assignment					
			Wheel	Center	Left	Right	Up	Down
☚	MODE	Flash mode setting	-	✓	✓	✓	✓	✓ ^(*1) ✓ ^(*2)
	TTL/M SWITCH (HVL-F60RM/HVL-F60RM2)	Flash mode switching (TTL/MANUAL)	-	✓	✓	✓	✓	✓
	☚/LEVEL	Flash power level setting	✓	✓	✓ ^(*2)	✓	✓	✓
	☚_POS SELECT (HVL-F60RM/HVL-F60RM2)	Item selection for direct flash power setting	✓	✓	✓	✓	✓	✓
	ZOOM	Flash coverage (zoom) setting	✓	✓	✓	✓	✓ ^(*1) ✓ ^(*2)	✓
	CMD/CTRL FLASH (HVL-F60RM)	Commander/Control unit flash setting	-	✓	✓	✓	✓	✓
	CMD FLASH (HVL-F60RM2/HVL-F46RM)	Commander unit flash setting	-	✓	✓	✓	✓	✓
	FLASH DISTRIBUT.	Flash distribution setting	-	✓	✓	✓	✓	✓
	HSS	High-speed sync setting	-	✓	✓	✓	✓	✓
	RATIO CONTROL	Lighting ratio setting	-	✓	✓	✓	✓	✓
	RATIO VALUE	Flash power level ratio setting	-	✓	✓	✓	✓	✓
	MODE(GROUP)	Group flash mode setting	-	✓	✓	✓	✓	✓
	LIGHT MODE (HVL-F60RM)	LED light ON/OFF setting	-	✓	✓	✓	✓	✓
	RECALL	Calling up pre-registered settings	-	✓	✓	✓	✓	✓
MEMORY	Preference registration	-	✓	✓	✓	✓	✓	
☚☚	WL MODE	Wireless mode setting	-	✓	✓	✓ ^(*1) ✓ ^(*2)	✓	✓
	REMOTE RELEASE (HVL-F60RM/HVL-F60RM2)	Remote release mode setting	-	✓	✓	✓	✓	✓
	RECEIVER SET	Individual receiver setting	-	✓	✓	✓	✓	✓
	GROUP	Wireless group setting	-	✓	✓	✓	✓	✓
	RCV REMOTE	Receiver remote setting	-	✓	✓	✓	✓	✓
	CH SET	Channel setting (radio control)	-	✓	✓	✓	✓	✓
	☚☚ CH SET (HVL-F60RM)	Channel setting (optical control)	-	✓	✓	✓	✓	✓
OTHERS	NOT SET	No setting	✓ ^(*1) ✓ ^(*2)	✓ ^(*1) ✓ ^(*2)	✓ ^(*1)	✓	✓	✓

*1 Factory default setting (HVL-F60RM/HVL-F60RM2)

*2 Factory default setting (HVL-F46RM)

Flash
HVL-F60RM/HVL-F60RM2/HVL-F46RM

Viewing the version information of this flash unit/the receiver unit <VERSION>

You can view the version information about this flash unit and the paired receiver unit(s). Check this information when a firmware update is released.

- 1 Press the MENU button and select [VERSION].

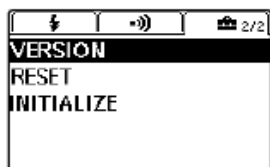

- 2 Select the device about which information you want to view.

Menu item details

Flash:

The information about the version and model name of this flash unit is displayed.

RCV:

The information about the receiver unit, including the version, pairing registration number, model name. The information to be displayed varies depending on the radio conditions.

When no receiver units are paired, [RCV] is not available for selection.

Flash
HVL-F60RM/HVL-F60RM2/HVL-F46RM

Resetting the settings for the Quick Navi screen <RESET>

You can reset the settings you have changed with the Quick Navi screen to the factory default settings.

- 1 Press the MENU button and select [RESET].

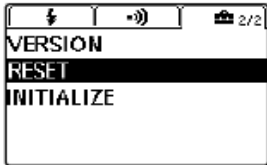

- 2 Select [OK].

Note

- The reset operation also resets the flash distribution setting, the LED brightness setting (HVL-F60RM), and the remote release mode setting (HVL-F60RM/HVL-F60RM2).
- While the reset process is in progress, do not turn off the power to this flash unit or remove the batteries.

Flash
HVL-F60RM/HVL-F60RM2/HVL-F46RM

Restoring the factory default settings <INITIALIZE>

You can restore all the functional settings and the set values to the factory default settings.

- 1 Press the MENU button and select [INITIALIZE].

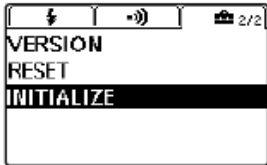

- 2 Select [OK].

Note

- While the initialize process is in progress, do not turn off the power to this flash unit or remove the batteries.

Flash
HVL-F60RM/HVL-F60RM2/HVL-F46RM

Notes on use

In addition to this Help Guide, please read “Before use” or “Notes on use” in the Operating Instructions/Startup Guide.

While photographing

- This flash unit generates strong light, so it should not be used directly in front of the eyes.
- Do not use the flash 20 times in succession in order to prevent heating and degradation of the camera and flash unit. When the flash power level is 1/32 (camera shutter speed of less than 1/250), the maximum times the flash units are capable of flashing in succession are as follows:
 - HVL-F60RM: 40 times
 - HVL-F60RM2: 200 times
 - HVL-F46RM: 60 times

Stop using the flash unit and let it cool down for 20 minutes or more (HVL-F60RM/HVL-F60RM2) or for 10 minutes or more (HVL-F46RM) if the flash is triggered up to the limit for the number of times in succession.

- During wireless photography, this flash unit may fire unexpectedly because the unit is unable to receive communication signals from an off-camera flash due to its location. In such a case, change the location of the off-camera flash or the wireless channel setting.
- Do not put this flash unit with the camera attached in the bag, etc. It may result in a malfunction of this flash unit or the camera.
- Do not carry this flash unit with the camera attached. It may result in a malfunction.
- Do not use the flash near people when rotating the flashlamp during bounce photography. The flash light may damage the eyes, or the hot flashlamp may cause a burn.
- When rotating the flashlamp, be careful not to catch your fingers in the rotating part. You may be injured.
- When closing the battery chamber door, press it firmly in while sliding it fully across. Be careful not to injure yourself by catching your finger in the battery chamber door when closing it.

Batteries

- The battery level displayed on the LCD panel may be lower than the actual battery capacity, due to temperature and storage conditions. The displayed battery level may be restored to the correct value after the flash has been used a few times.
- Nickel-metal hydride batteries can lose power suddenly. If the low-battery indicator starts blinking or the flash can no longer be used while taking pictures, change or recharge the batteries.
- Do not use lithium-ion batteries in this flash unit as they may prevent the flash unit from delivering full performance.
- The flash frequency and number of flashes provided by new batteries may vary from the values shown in the table, depending on the time elapsed since manufacture of the batteries.
- Remove the batteries only after turning the power off and waiting several minutes, when changing the batteries. The batteries may be hot, depending on the battery type. Remove them carefully.
- Remove and store the batteries when you do not intend to use the camera for a long time.

Temperature

- The flash unit may be used over a temperature range of 0 °C to 40 °C (32 °F to 104 °F).
- Do not expose the flash unit to extremely high temperatures (e.g. in direct sunlight inside a vehicle) or high humidity.
- To prevent condensation forming on the flash, place it in a sealed plastic bag when bringing it from a cold environment into a warm environment. Allow it to reach room temperature before removing it from the bag.
- Battery capacity decreases at colder temperatures. Keep your camera and spare batteries in a warm inside pocket when shooting in cold weather. The low-battery indicator may blink even when there is some power left in the batteries in cold weather. Batteries will regain some of their capacity when warmed to normal operating temperature.

Do not use/store the product in the following places

- In an extremely hot, cold or humid place
In places such as in a car parked in the sun, the flash unit may become deformed and this may cause a malfunction.
- Storing under direct sunlight or near a heater
The flash unit may become discolored or deformed, and this may cause a malfunction.
- In a location subject to rocking vibration
- Near strong magnetic place
- In sandy or dusty places
Be careful not to let sand or dust get into the product. This may cause the product to malfunction, and in some cases this malfunction cannot be repaired.

Safety

To avoid hazards, such as a fire or an electrical shock, observe the following.

- Do not carry around or store this flash unit along with metal objects, such as coins and hairpins.
- Do not attempt to disassemble this unit, or make an alteration or a short circuit on this flash unit.
- Do not use this flash unit when it is wrapped.
Heat build-up may cause deformation of the flash unit or a fire.
- Do not use this flash unit in a place subject to explosive or combustible gas.
- If use of this flash unit causes radio interference with other devices, stop using the wireless functions.
Radio interference may cause malfunctions, resulting in incidents.
- Place this flash unit on a stable place.
Placing the flash unit on a wobbling table or a tilted surface may cause the flash unit to fall off, resulting in injuries.
- Before attaching this flash unit to a camera, make sure that the flash unit is not powered.
Attaching the powered flash unit to a camera may cause malfunctions or unexpected flashes, resulting in eye damage by strong light.

Maintenance

- Remove this unit from the camera. Clean the flash with a dry soft cloth. If the flash has been in contact with sand, wiping will damage the surface, and it should therefore be cleaned gently using a blower. In the event of stubborn stains, use a cloth lightly moistened with water or tepid water, and then wipe the unit clean with a dry soft cloth. Never use strong solvents, such as thinner or benzine, as these damage the surface finish.
- If fingerprints or particles are stuck to the flashlamp, we recommend that you wipe it clean with a soft cloth.

4-735-263-14(1) Copyright 2018 Sony Corporation

Flash
HVL-F60RM/HVL-F60RM2/HVL-F46RM

Specifications

Flash unit

Flash control	Flash control using pre-flash (P-TTL/ADI)
Continuous flash performance	40 flashes (HVL-F60RM)/200 flashes (HVL-F60RM2)/60 flashes (HVL-F46RM) at 10 flashes per second (Normal flash, flash power level 1/32, camera shutter speed of less than 1/250, nickel-metal hydride batteries)
AF illuminator (HVL-F60RM)	<p>Autoflash at low contrast and low brightness Operating range (While a 50mm lens with the aperture set at F5.6 is attached.)</p> <ul style="list-style-type: none"> ● [AF LED LEVEL] of the flash unit is specified as [LOW] <ul style="list-style-type: none"> – Central area (Approx.): 0.5 m to 3 m (1 ft. 7 3/4 in. to 9 ft. 10 1/8 in.) – Peripheral areas (Approx.): 0.5 m to 2 m (1 ft. 7 3/4 in. to 6 ft. 6 3/4 in.) ● [AF LED LEVEL] of the flash unit is specified as [HIGH] <ul style="list-style-type: none"> – Central area (Approx.): 0.5 m to 10 m (1 ft. 7 3/4 in. to 32 ft. 9 3/4 in.) – Peripheral areas (Approx.): 0.5 m to 6 m (1 ft. 7 3/4 in. to 19 ft. 8 1/4 in.)
LED light (HVL-F60RM)	<ul style="list-style-type: none"> ● Center luminance intensity: Approx. 1 200 lx at 0.5 m (1 ft. 7 3/4 in.) or approx. 300 lx at 1 m (3 ft. 3 3/8 in.) ● Lighting distance: Approx. 2 m (6 ft. 6 3/4 in.) (when recording movies, set to ISO 3200 & F5.6) ● Focal length supported: 35 mm (35mm-format angle of view) ● Continuous lighting time: Approx. 1 hour (using AA alkaline batteries, at center luminance intensity) ● Color temperature: Approx. 5 500 K
Operating temperature	0 °C to 40 °C (32 °F to 104 °F)
Storage temperature	HVL-F60RM: -20 °C to +60 °C (-4 °F to +140 °F) HVL-F60RM2/HVL-F46RM: -20 °C to +55 °C (-4 °F to +131 °F)
Dimension (w/h/d) (Approx.)	HVL-F60RM: 78.1 mm × 139.5 mm × 104.6 mm (3 1/8 in. × 5 1/2 in. × 4 1/8 in.) HVL-F60RM2: 78.1 mm × 143.1 mm × 104.6 mm (3 1/8 in. × 5 3/4 in. × 4 1/8 in.) HVL-F46RM: 69.4 mm × 114.7 mm × 88.9 mm (2 3/4 in. × 4 5/8 in. × 3 1/2 in.)
Mass (Approx.)	HVL-F60RM: 449 g (15.9 oz) (excluding the batteries) HVL-F60RM2: 439 g (15.5 oz) (excluding the batteries) HVL-F46RM: 308 g (10.9 oz) (excluding the batteries)
Power requirements	DC 6 V
Recommended batteries	<ul style="list-style-type: none"> ● Four LR6 (AA-size) alkaline batteries ● Four AA-size rechargeable nickel-metal hydride batteries

Flash frequency/count

The flash count indicates the approximate number of flashes available before new batteries wear out.

- HVL-F60RM

Flash frequency/count	With alkaline batteries	With nickel-metal hydride batteries
Flash frequency (sec)(*1)	Approx. 0.1 - 2.5	Approx. 0.1 - 1.7
Flash count (times)(*2)	Approx. 150 or more	Approx. 220 or more

- HVL-F60RM2

Flash frequency/count	With alkaline batteries	With nickel-metal hydride batteries
Flash frequency (sec)(*1)	Approx. 0.1 - 2.5	Approx. 0.1 - 1.7
Flash count (times)(*2)	Approx. 160 or more	Approx. 240 or more

- HVL-F46RM

Flash frequency/count	With alkaline batteries	With nickel-metal hydride batteries
Flash frequency (sec)(*1)	Approx. 0.1 - 2.5	Approx. 0.1 - 2.0
Flash count (times)(*2)	Approx. 240 or more	Approx. 320 or more

*1 Minimum duration of time before the TEST button lights after the previous flash (Acquired under our measurement conditions.) (HVL-F60RM2/HVL-F46RM (flash unit software version 2.00 or later): When [CHG PRIORITY] is set to [NORMAL])

*2 Number of flashes at the highest flash power level available in every 30 seconds (Acquired under our measurement conditions.)

Functions in this manual depend on testing conditions at our firm.

Design and specifications are subject to change without notice.

Flash
HVL-F60RM/HVL-F60RM2/HVL-F46RM

Guide number (HVL-F60RM/HVL-F60RM2)

Normal flash/STD flash distribution (ISO 100)

- Manual flash/35mm-format

Flash power level	BA(*1)(*2)	BA(*1)	Flash coverage setting (mm)									
			14(*2)	20	24	28	35	50	70	105	135	200
1/1	16	23	14	25	26	28	30	37	46	49	54	60
1/2	11.3	16.3	9.9	17.7	18.4	19.8	21.2	26.2	32.5	34.6	38.2	42.4
1/4	8	11.5	7	12.5	13	14	15	18.5	23	24.5	27	30
1/8	5.7	8.1	4.9	8.8	9.2	9.9	10.6	13.1	16.3	17.3	19.1	21.2
1/16	4	5.8	3.5	6.3	6.5	7	7.5	9.3	11.5	12.3	13.5	15
1/32	2.8	4.1	2.5	4.4	4.6	4.9	5.3	6.5	8.1	8.7	9.5	10.6
1/64	2	2.9	1.8	3.1	3.3	3.5	3.8	4.6	5.8	6.1	6.8	7.5
1/128	1.4	2	1.2	2.2	2.3	2.5	2.7	3.3	4.1	4.3	4.8	5.3
1/256	1	1.4	0.9	1.6	1.6	1.8	1.9	2.3	2.9	3.1	3.4	3.8

*1 When the bounce adaptor is attached.

*2 When the wide panel is attached.

- APS-C format

Flash power level	BA(*1)(*2)	BA(*1)	Flash coverage setting (mm)									
			14(*2)	20	24	28	35	50	70	105	135	200
1/1	16	23	14	26	27	30	37	46	47	49	54	60
1/2	11.3	16.3	9.9	18.4	19.1	21.2	26.2	32.5	33.2	34.6	38.2	42.4
1/4	8	11.5	7	13	13.5	15	18.5	23	23.5	24.5	27	30
1/8	5.7	8.1	4.9	9.2	9.5	10.6	13.1	16.3	16.6	17.3	19.1	21.2
1/16	4	5.8	3.5	6.5	6.8	7.5	9.3	11.5	11.8	12.3	13.5	15
1/32	2.8	4.1	2.5	4.6	4.8	5.3	6.5	8.1	8.3	8.7	9.5	10.6
1/64	2	2.9	1.8	3.3	3.4	3.8	4.6	5.8	5.9	6.1	6.8	7.5
1/128	1.4	2	1.2	2.3	2.4	2.7	3.3	4.1	4.2	4.3	4.8	5.3
1/256	1	1.4	0.9	1.6	1.7	1.9	2.3	2.9	2.9	3.1	3.4	3.8

*1 When the bounce adaptor is attached.

*2 When the wide panel is attached.

HSS flat flash/STD flash distribution (ISO 100)

- Manual flash/35mm-format (maximum possible exposure GN conversion value for each zoom position)

Shutter speed	BA(*1)(*2)	BA(*1)	Flash coverage setting (mm)									
			14(*2)	20	24	28	35	50	70	105	135	200
1/250	4.6	6.4	4.2	7	7.7	8.4	8.4	10.8	12.9	14	15.3	16.7
1/500	3.2	4.6	3	5	5.4	5.9	5.9	7.7	9.1	9.9	10.8	11.8
1/1000	2.3	3.2	2.1	3.5	3.8	4.2	4.2	5.4	6.4	7	7.7	8.4
1/2000	1.6	2.3	1.5	2.5	2.7	3	3	3.8	4.6	5	5.4	5.9
1/4000	1.1	1.6	1	1.8	1.9	2.1	2.1	2.7	3.2	3.5	3.8	4.2
1/8000	0.8	1.1	0.7	1.2	1.4	1.5	1.5	1.9	2.3	2.5	2.7	3
1/16000	0.6	0.8	0.5	0.9	1	1	1	1.4	1.6	1.8	1.9	2.1

*1 When the bounce adaptor is attached.

*2 When the wide panel is attached.

- APS-C format (maximum possible exposure GN conversion value for each zoom position)

Shutter speed	BA(*1)(*2)	BA(*1)	Flash coverage setting (mm)									
			14(*2)	20	24	28	35	50	70	105	135	200
1/250	4.6	6.4	4.2	7.7	7.7	8.4	10.8	12.9	14	14	15.3	16.7
1/500	3.2	4.6	3	5.4	5.4	5.9	7.7	9.1	9.9	9.9	10.8	11.8
1/1000	2.3	3.2	2.1	3.8	3.8	4.2	5.4	6.4	7	7	7.7	8.4
1/2000	1.6	2.3	1.5	2.7	2.7	3	3.8	4.6	5	5	5.4	5.9
1/4000	1.1	1.6	1	1.9	1.9	2.1	2.7	3.2	3.5	3.5	3.8	4.2
1/8000	0.8	1.1	0.7	1.4	1.4	1.5	1.9	2.3	2.5	2.5	2.7	3
1/16000	0.6	0.8	0.5	1	1	1	1.4	1.6	1.8	1.8	1.9	2.1

*1 When the bounce adaptor is attached.

*2 When the wide panel is attached.

Global shutter sync flash/STD flash distribution (ISO 100) (HVL-F60RM2 (flash unit software version 2.00 or later))

- Manual flash/35mm-format (maximum possible exposure GN conversion value for each zoom position)

Shutter speed	BA(*1)(*2)	BA(*1)	Flash coverage setting (mm)									
			14(*2)	20	24	28	35	50	70	105	135	200
1/250	16	23	14	25	26	28	30	37	46	49	54	60
1/500	14.4	21.2	12.6	23.1	24.1	26.3	27.5	34.1	42.4	44.3	50.4	55
1/1000	11.8	17.4	10.4	19	19.9	21.7	22.6	28.1	34.9	36.4	41.5	45.3
1/2000	9.1	13.5	8	14.7	15.3	16.7	17.4	21.7	26.9	28.1	32	34.9
1/4000	6.7	9.9	5.9	10.8	11.3	12.3	12.9	16	19.9	20.7	23.6	25.8
1/8000	4.8	7	4.2	7.7	8	8.7	9.1	11.3	14.1	14.7	16.7	18.2
1/16000	3.4	5	3	5.4	5.7	6.2	6.4	8	9.9	10.4	11.8	12.9
1/32000	2.4	3.5	2.1	3.8	4	4.4	4.6	5.7	7	7.3	8.4	9.1
1/64000	1.7	2.5	1.5	2.7	2.8	3.1	3.2	4	5	5.2	5.9	6.4
1/80000	1.5	2.2	1.3	2.4	2.5	2.8	2.9	3.6	4.5	4.7	5.3	5.8

*1 When the bounce adaptor is attached.

*2 When the wide panel is attached.

- APS-C format (maximum possible exposure GN conversion value for each zoom position)

Shutter speed	BA(*1)(*2)	BA(*1)	Flash coverage setting (mm)									
			14(*2)	20	24	28	35	50	70	105	135	200
1/250	16	23	14	26	27	30	37	46	47	49	54	60
1/500	14.4	21.2	12.6	24.1	25.2	27.5	34.1	42.4	42.4	44.3	50.4	55
1/1000	11.8	17.4	10.4	19.9	20.7	22.6	28.1	34.9	34.9	36.4	41.5	45.3
1/2000	9.1	13.5	8	15.3	16	17.4	21.7	26.9	26.9	28.1	32	34.9
1/4000	6.7	9.9	5.9	11.3	11.8	12.9	16	19.9	19.9	20.7	23.6	25.8
1/8000	4.8	7	4.2	8	8.4	9.1	11.3	14.1	14.1	14.7	16.7	18.2
1/16000	3.4	5	3	5.7	5.9	6.4	8	9.9	9.9	10.4	11.8	12.9
1/32000	2.4	3.5	2.1	4	4.2	4.6	5.7	7	7	7.3	8.7	9.1
1/64000	1.7	2.5	1.5	2.8	3	3.2	4	5	5	5.2	6.2	6.4
1/80000	1.5	2.2	1.3	2.5	2.7	2.9	3.6	4.5	4.5	4.7	5.5	5.8

*1 When the bounce adaptor is attached.

*2 When the wide panel is attached.

Flash
HVL-F60RM/HVL-F60RM2/HVL-F46RM

Guide number (HVL-F46RM)

Normal flash/STD flash distribution (ISO 100)

- Manual flash/35mm-format

Flash power level	Flash coverage setting (mm)						
	15(*)	24	28	35	50	70	105
1/1	13	23	25	26	30	36	46
1/2	9.2	16.3	17.7	18.4	21.2	25.5	32.5
1/4	6.5	11.5	12.5	13	15	18	23
1/8	4.6	8.1	8.8	9.2	10.6	12.7	16.3
1/16	3.3	5.8	6.3	6.5	7.5	9	11.5
1/32	2.3	4.1	4.4	4.6	5.3	6.4	8.1
1/64	1.6	2.9	3.1	3.3	3.8	4.5	5.8
1/128	1.1	2	2.2	2.3	2.7	3.2	4.1

* When the wide panel is attached.

- APS-C format

Flash power level	Flash coverage setting (mm)						
	15(*)	24	28	35	50	70	105
1/1	13	24	26	30	36	41	46
1/2	9.2	17	18.4	21.2	25.5	29	32.5
1/4	6.5	12	13	15	18	20.5	23
1/8	4.6	8.5	9.2	10.6	12.7	14.5	16.3
1/16	3.3	6	6.5	7.5	9	10.3	11.5
1/32	2.3	4.2	4.6	5.3	6.4	7.2	8.1
1/64	1.6	3	3.3	3.8	4.5	5.1	5.8
1/128	1.1	2.1	2.3	2.7	3.2	3.6	4.1

* When the wide panel is attached.

HSS flat flash/STD flash distribution (ISO 100)

- Manual flash/35mm-format (maximum possible exposure GN conversion value for each zoom position)

Shutter speed	Flash coverage setting (mm)						
	15(*)	24	28	35	50	70	105
1/250	4.6	8.4	9.1	9.5	11.3	12.9	16
1/500	3.2	5.9	6.4	6.7	8	9.1	11.3

Shutter speed	Flash coverage setting (mm)						
	15(*)	24	28	35	50	70	105
1/1000	2.3	4.2	4.6	4.8	5.7	6.4	8
1/2000	1.6	3	3.2	3.4	4	4.6	5.7
1/4000	1.1	2.1	2.3	2.4	2.8	3.2	4
1/8000	0.8	1.5	1.6	1.7	2	2.3	2.8
1/16000	0.6	1	1.1	1.2	1.4	1.6	2

* When the wide panel is attached.

- APS-C format (maximum possible exposure GN conversion value for each zoom position)

Shutter speed	Flash coverage setting (mm)						
	15(*)	24	28	35	50	70	105
1/250	4.6	8.7	9.5	11.3	12.9	15.3	16
1/500	3.2	6.2	6.7	8	9.1	10.8	11.3
1/1000	2.3	4.4	4.8	5.7	6.4	7.7	8
1/2000	1.6	3.1	3.4	4	4.6	5.4	5.7
1/4000	1.1	2.2	2.4	2.8	3.2	3.8	4
1/8000	0.8	1.5	1.7	2	2.3	2.7	2.8
1/16000	0.6	1.1	1.2	1.4	1.6	1.9	2

* When the wide panel is attached.

Global shutter sync flash/STD flash distribution (ISO 100) (flash unit software version 2.00 or later)

- Manual flash/35mm-format (maximum possible exposure GN conversion value for each zoom position)

Shutter speed	Flash coverage setting (mm)						
	15(*)	24	28	35	50	70	105
1/250	13	23	25	26	30	36	46
1/500	11.8	20.7	22.6	23.6	26.9	33.4	41.5
1/1000	9.9	17.4	19	19.9	22.6	28.1	34.9
1/2000	7.5	13.2	14.4	15	17.1	21.2	26.3
1/4000	5.5	9.7	10.6	11.1	12.6	15.7	19.4
1/8000	4.1	7.2	7.8	8.2	9.3	11.6	14.4
1/16000	3	5.2	5.7	5.9	6.7	8.4	10.4
1/32000	2.1	3.7	4	4.2	4.8	5.9	7.3
1/64000	1.5	2.7	2.9	3	3.4	4.3	5.3
1/80000	1.3	2.3	2.5	2.7	3	3.7	4.7

* When the wide panel is attached.

- APS-C format (maximum possible exposure GN conversion value for each zoom position)

Shutter speed	Flash coverage setting (mm)						
	15(*)	24	28	35	50	70	105
1/250	13	24	26	30	36	41	46
1/500	11.8	21.7	23.6	26.9	33.4	38.1	41.5
1/1000	9.9	18.2	19.9	22.6	28.1	32	34.9
1/2000	7.5	13.7	15	17.1	21.2	24.1	26.3
1/4000	5.5	10.2	11.1	12.6	15.7	17.8	19.4
1/8000	4.1	7.5	8.2	9.3	11.6	13.2	14.4
1/16000	3	5.4	5.9	6.7	8.4	9.5	10.4
1/32000	2.1	3.8	4.2	4.8	5.9	6.7	7.3
1/64000	1.5	2.8	3	3.4	4.3	4.9	5.3
1/80000	1.3	2.4	2.7	3	3.7	4.3	4.7

* When the wide panel is attached.

Flash
HVL-F60RM/HVL-F60RM2/HVL-F46RM

Radio wireless features

The following lists the specifications of radio wireless features on this flash unit.

Frequency band	2.4 GHz
Number of channels	14 channels
Communication distance	<p>Approximately 30 m (98.4 ft.) (Acquired under our measurement conditions.)</p> <ul style="list-style-type: none">● The distance given above applies under conditions where there are no obstacles, shielding, or radio wave interferences.● The communication distance may be shorter depending on the positioning of the products, the ambient environment, and weather conditions.

Flash
HVL-F60RM/HVL-F60RM2/HVL-F46RM

Trademarks

- “Multi Interface Shoe” is a trademark of Sony Group Corporation.

Flash
HVL-F60RM/HVL-F60RM2/HVL-F46RM

License

This product comes with software that is used based on licensing agreements with the owners of that software. Based on requests by the owners of copyright of these software applications, we have an obligation to inform you of contents of the agreement.

For the software used on this product, visit the website at:

https://helpguide.sony.net/ilc/flash_oss1/v1/en/index.html

Flash
HVL-F60RM/HVL-F60RM2/HVL-F46RM

Warning indications



Firing in succession for a short period of time may cause the temperature inside this flash unit to rise. Changes in temperature are indicated by the icons on the LCD display or by the beep sound (HVL-F60RM/HVL-F60RM2) according to the internal temperature value. While this flash unit is in any warning state, flash charge-up is suspended.

HVL-F60RM/HVL-F60RM2

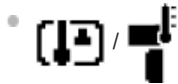

Indicates that the internal temperature is too high for this flash unit to fire (the flash unit is overheated). While [ON] is selected for [BEEP] on the MENU screen, this state is also indicated by the beep sound. Turn off the power to the flash unit and leave it unused for about 20 minutes.



Indicates that this flash unit is likely to be overheated. While the flash unit is in this state, flash charge-up is suspended for about 11 seconds. While [ON] is selected for [BEEP] on the MENU screen, this state is also indicated by the beep sound.



Indicates that the internal temperature is extremely high. While the flash unit is in this state, flash charge-up is suspended for about 8 seconds. This warning state is not indicated by the beep sound.

HVL-F46RM



Indicates that the internal temperature is too high for this flash unit to fire (the flash unit is overheated). Turn off the power to the flash unit and leave it unused for about 10 minutes.