

**RICOH**

**GR**

RICOH GR IIIx

# Operating Manual

The serial number is located on the bottom of the camera.

## Chapter 1: Introduction

**Read this chapter before use.**

This chapter gives you an overview of the RICOH GR IIIx.

## Chapter 2: Getting Started

**Read this chapter before using the RICOH GR IIIx for the first time.**

This chapter explains about basic operations such as turning the camera on, performing shooting, and playing back images.

## Chapters 3 and Later

**Read these chapters when you want to learn more about the different camera functions.**

These chapters explain about shooting and playback functions, as well as how to customize the camera settings and use it with a computer.

**Model:** R05010

## Regarding User Registration

Thank you for purchasing a RICOH IMAGING product.

In order to provide you with the best customer support and service experience for the product you have purchased, we ask you to complete the user registration.

Visit the following website to complete the user registration.

**<https://www.ricoh-imaging.com/registration/>**

Registered users will be notified by e-mail about important customer support information, such as firmware version updates, etc.

# Introduction

This Operating Manual provides information on how to use the shooting and playback functions of this camera and related precautions.

Thoroughly read this Operating Manual to make the best use of the functions available with this camera. Be sure to keep this Operating Manual for future reference.

It is recommended to update the camera firmware to the latest version before using the camera.

For details on the latest firmware version, refer to the following firmware download site.  
<https://www.ricoh-imaging.co.jp/english>

RICOH IMAGING COMPANY, LTD.

Safety precautions	Read all safety precautions thoroughly to ensure safe use.
Test shots	Take test shots to ensure that the camera is working properly before taking pictures on important occasions.
Copyright	Reproduction or alteration of copyrighted documents, magazines, and other materials, other than for personal, home, or other similarly limited purposes, without the consent of the copyright holder, is prohibited.
Exemption from liability	RICOH IMAGING COMPANY assumes no liability for failure to record or display images as a result of product malfunction.
Radio interference	Operating this camera in the vicinity of other electronic equipment may adversely affect both the camera and the other device. Interference is particularly likely if the camera is used in close proximity to a radio/TV receiver. In such case, take the following measures. <ul style="list-style-type: none"><li>• Keep the camera as far away as possible from the radio/TV receiver.</li><li>• Reorient the antenna of the radio/TV receiver.</li><li>• Use a different wall outlet.</li></ul>

This publication may not be reproduced in whole or in part without RICOH IMAGING COMPANY's express written permission.

© RICOH IMAGING COMPANY, LTD. 2022

RICOH IMAGING COMPANY reserves the right to change the contents of this manual at any time without prior notice.

Every effort has been made to ensure the accuracy of the information in this manual. Should you nevertheless notice any errors or omissions, we would be grateful if you would notify us at the address listed on the back cover of this manual.

## About the Wireless LAN and Bluetooth® Functions

- Do not use the camera in a place where electrical products, AV/OA devices, and so on generate magnetic fields and electromagnetic waves.
- If the camera is affected by magnetic fields and electromagnetic waves, it may not be able to communicate.
- If the camera is used near a TV or a radio, poor reception or TV screen glitch may occur.
- If there are multiple wireless LAN access points or Bluetooth® devices near the camera and the same channel is used, search operation may not be executed correctly.
- The security of your data stored, sent, or received is your own responsibility.

In the frequency band used by the camera, along with industrial, scientific, and medical devices such as microwave ovens, premises radio stations (wireless stations requiring license) and specified low power radio stations (wireless stations not requiring license) for mobile object identification used in factory production lines, etc., and amateur radio stations (wireless stations requiring license) are operated.

1. Before using the camera, confirm that premises radio stations and specified low power radio stations for mobile object identification and amateur radio stations are not operated in the vicinity.
2. In the event that the camera causes harmful radio wave interference to premises radio stations for mobile object identification, immediately change the frequency being used to avoid interference.
3. If you have other troubles such that the camera causes harmful radio wave interference to specified low power radio stations for mobile object identification or to amateur radio stations, contact your nearest service center.

This camera conforms to the technical standards under the Radio Law and Telecommunications Business Law. The certification of conformance to technical standards can be displayed electronically on the monitor.



### Displaying the Certification Marks

- 1 Press **MENU** to display the menu screen.
- 2 Use **▲▼◀▶** to display the **⌘ 8** menu (About This Device).
- 3 Use **▲▼◀▶** to select [Certification Marks], and press **OK**.

Cet appareil est conforme aux normes techniques de la législation sur la radio et les télécommunications. La certification de la conformité avec les normes techniques peut être affichée électroniquement sur l'écran.



### Affichage des marques de certification

- 1 Appuyez sur **MENU** pour afficher l'écran de menu.
- 2 Utilisez **▲▼◀▶** pour afficher le menu **⌘ 8** (À propos de l'appareil).
- 3 Utilisez **▲▼◀▶** pour sélectionner [Marques de certification], et appuyez sur **OK**.

## Trademarks

- Microsoft and Windows are registered trademarks of Microsoft Corporation in the United States of America and other countries.
  - Mac, macOS, OS X, and App Store are trademarks of Apple Inc., registered in the U.S. and other countries.
  - IOS is a trademark or registered trademark of Cisco in the U.S. and other countries and is used under license.
  - Adobe, the Adobe logo, and Adobe Reader are registered trademarks or trademarks of Adobe Systems Incorporated in the United States and/or other countries.
  - This product includes DNG technology under license by Adobe Systems Incorporated.
  - The DNG logo is either a registered trademark or trademark of Adobe Systems Incorporated in the United States and/or other countries.
  - SDXC Logo is a trademark of SD-3C, LLC.
  - Google, Google Play, and Android are trademarks or registered trademarks of Google Inc.
  - The Bluetooth® word mark and logos are registered trademarks owned by Bluetooth SIG, Inc., and any use of such marks by Ricoh Company, Ltd. is under license.
  - USB Type-C is a trademark of USB Implementers Forum.
  - DisplayPort is a trademark owned by the Video Electronics Standards Association in the United States and other countries.
  - HDMI, the HDMI logo, and High-Definition Multimedia Interface are trademarks or registered trademarks of HDMI Licensing, LLC in the United States and/or other countries.
- All other trademarks are the property of their respective owners.
- This product uses the RICOH RT font designed by Ricoh Company Ltd.

### AVC Patent Portfolio License

This product is licensed under the AVC Patent Portfolio License for the personal use of a consumer or other uses in which it does not receive remuneration to (i) encode video in compliance with the AVC standard ("AVC video") and/or (ii) decode AVC video that was encoded by a consumer engaged in a personal activity and/or was obtained from a video provider licensed to provide AVC video. No license is granted or shall be implied for any other use. Additional information may be obtained from MPEG LA, L.L.C. See <https://www.mpegla.com>.



### Announcement about the Open Source Software

This product includes the open source software (OSS) licensed under the GNU General Public License (GPL), GNU Lesser General Public License (LGPL), and/or other licenses. The information about licenses of each OSS used in this product is saved in the product internal memory as a text file. Connect this product to a computer, access the "oss\_license" folder in the "Software License" folder, and open the text file to read the license terms. The source codes of OSS used in this product are disclosed under the license terms of GPL, LGPL, etc. If you need the source codes, access the following URL.  
<https://www.ricoh-imaging.co.jp/english/products/oss/>

# Safety Precautions

## Warning Symbols

Various symbols are used throughout this Operating Manual and on the product to prevent physical harm to you or other people and damage to property. The symbols and their meanings are explained below.





 <b>Danger</b>	This symbol indicates matters that may lead to imminent risk of death or serious injury if ignored or incorrectly handled.
 <b>Warning</b>	This symbol indicates matters that may lead to death or serious injury if ignored or incorrectly handled.
 <b>Caution</b>	This symbol indicates matters that may lead to injury or physical damage if ignored or incorrectly handled.

## Meaning of Symbols



The  symbol alerts you to actions that must be performed.



The  symbol alerts you to prohibited actions.  
The  symbol may be combined with other symbols to indicate that a specific action is prohibited.  
Example:  
 Do not touch    Do not disassemble

Observe the following precautions to ensure safe use of this camera.

## **Danger**



- Do not attempt to disassemble, repair, or alter the camera yourself. The high-voltage circuitry in the equipment poses significant electrical hazard.



- Do not attempt to disassemble, alter, or directly solder the battery.



- Do not put the battery in a fire, attempt to heat it, use or leave it in a high temperature environment such as next to a fire or inside a car. Do not put it into water or the sea or allow it to get wet.



- Do not attempt to pierce, hit, compress, drop, or subject the battery to any other severe impact or force.



- Do not use a battery that is significantly damaged or deformed.



- Do not connect the positive (+) and negative (-) poles of the battery with a wire or other metallic item. Also, do not carry or store together with metal objects such as ballpoint pens and necklaces.



- Use the camera or optional battery charger BJ-11 to charge the battery. Do not use the battery with any camera except the cameras compatible with the DB-110.



- Stop using the camera immediately in the event of abnormalities such as smoke, unusual odors, or excessive heat being emitted. Contact your nearest dealer or service center for repair.



- If the battery fluid leaks and gets into your eyes, immediately wash your eyes thoroughly with tap water or other clean water without rubbing, and seek medical attention immediately.



## Warning



- Turn off the power immediately in the event of abnormalities such as smoke or unusual odors being emitted. Remove the battery as soon as possible, being careful to avoid electric shocks or burns. If you are drawing power from a household electrical outlet, be sure to unplug the power plug from the outlet. Failure to observe this precaution could result in fire or electric shocks. Contact the nearest service center at your earliest convenience. Stop using the camera immediately if it is malfunctioning.



- Turn off the power immediately if any metallic object, water, liquid, or other foreign object gets into the camera. Remove the battery and memory card as soon as possible, being careful to avoid electric shocks or burns. If you are drawing power from a household electrical outlet, be sure to unplug the power plug from the outlet. Failure to observe this precaution could result in fire or electric shocks. Contact the nearest service center at your earliest convenience. Stop using the camera immediately if it is malfunctioning.



- If the monitor is damaged, avoid any contact with the liquid crystal inside it. Follow the appropriate emergency measures below.
- SKIN: If any of the liquid crystal gets on your skin, wipe it off and rinse the affected area thoroughly with water, then wash well with soap.
- EYES: If it gets in your eyes, wash your eyes with clean water for at least 15 minutes and seek medical advice immediately.
- INGESTION: If any of the liquid crystal is ingested, rinse the mouth out thoroughly with water. Have the person drink a large amount of water and induce vomiting. Seek medical assistance immediately.



- Follow these precautions to prevent the battery from leaking, overheating, igniting, or exploding.
- Do not use a battery other than those specifically recommended for the camera.
- Do not carry or store the battery together with metal objects such as ball-point pens, necklaces, coins, and hairpins.
- Do not put the battery into a microwave or high pressure container.
- If leakage of battery fluid, a strange odor, color change, etc. is noticed during use or during charging, remove the battery from the camera or battery charger immediately and keep it away from fire.



- Observe the following in order to prevent fire, electrical shock, or cracking of the battery while charging.
- Use only the indicated power supply voltage. Also avoid the use of multi-socket adapters and extension cords.
- Do not damage, bundle, or alter power cords. Also, do not place heavy objects on, stretch, or bend power cords.
- Do not connect or disconnect the power plug with wet hands. Always grip the plug section when disconnecting a power plug. Do not cover the camera while charging the battery.



- Keep the battery and memory card used in the camera out of the reach of children to prevent accidental swallowing. The battery and memory card are harmful if swallowed. Seek medical assistance immediately.



- Keep the camera out of the reach of children. For children, accidents may occur because they cannot understand the contents of "Safety Precautions" and "Precautions for Use".



- Do not touch the internal components of the camera if they become exposed as a result of being dropped or damaged. The high-voltage circuitry in the equipment could lead to electric shocks. Remove the battery as soon as possible, being careful to avoid electric shocks or burns. Take the camera to your nearest dealer or service center if it is damaged.



- Do not use the camera in wet areas such as a kitchen. Failure to observe this precaution could result in fire or electric shocks.















- Do not use the camera near flammable gases, gasoline, benzene, thinner, or similar substances. Failure to observe this precaution could result in an explosion, fire, or burns.
- Do not use the camera in a location where usage is restricted or prohibited, such as on airplanes. Failure to observe this precaution could result in an accident.



- Wipe off any dust that accumulates on the power plug. Failure to observe this precaution could result in fire.
- When using a household power outlet, always use the dedicated AC adapter. Failure to observe this precaution could result in fire, electric shocks, or product malfunction.



	<ul style="list-style-type: none"> <li>Do not use the battery charger or AC adapter with commercially available electronic transformers when traveling abroad. Failure to observe this precaution could result in fire, electric shocks, or product malfunction.</li> </ul>
	<ul style="list-style-type: none"> <li>Use only the indicated power supply voltage. Failure to observe this precaution could result in fire or electric shocks.</li> </ul>
	<ul style="list-style-type: none"> <li>Do not damage, bundle, or alter power cords. Also, to avoid damaging power cords and the risk of fire or electric shocks, do not place heavy objects on, stretch, or bend power cords.</li> </ul>
	<ul style="list-style-type: none"> <li>Do not connect or disconnect the power plug with wet hands. Failure to observe this precaution could result in electric shocks.</li> </ul>
	<ul style="list-style-type: none"> <li>Always grip the plug section when disconnecting a power plug. Do not pull the power cord. This can damage the power cord and result in fire or electric shocks.</li> </ul>
	<ul style="list-style-type: none"> <li>If any metallic object, water, liquid, or other foreign object gets into the camera, immediately remove the power plug from the outlet and contact a service center for repair. Failure to observe this precaution could result in fire or electric shocks.</li> <li>If an abnormality such as an unusual sound or smoke is emitted from the camera, immediately remove the power plug from the outlet and contact your nearest dealer or service center for repair. Stop using the camera immediately if it is malfunctioning.</li> </ul>
	<ul style="list-style-type: none"> <li>Do not attempt to disassemble the camera yourself. The high-voltage circuitry in the equipment could lead to electric shocks.</li> </ul>
	<ul style="list-style-type: none"> <li>Do not use the camera in a bathroom. Failure to observe this precaution could result in fire or electric shocks.</li> </ul>
	<ul style="list-style-type: none"> <li>Do not touch the power plug during a lightning storm. Failure to observe this precaution could result in electric shocks.</li> </ul>
	<ul style="list-style-type: none"> <li>Keep the battery out of the reach of children.</li> </ul>
	<ul style="list-style-type: none"> <li>If the battery does not finish charging after the prescribed charging time, discontinue charging.</li> </ul>
	<ul style="list-style-type: none"> <li>Do not put the battery into a microwave or high pressure container.</li> </ul>
	<ul style="list-style-type: none"> <li>If the battery leaks or emits an unusual odor, immediately move it away from any sources of fire.</li> </ul>

 **Caution**



- Contact with fluid leaking from a battery can lead to burns. If part of your body comes in contact with a damaged battery, rinse the area with water immediately. (Do not use soap.)  
If a battery starts to leak, remove it immediately from the camera and wipe the battery chamber thoroughly before replacing it with a new battery.



- Plug the power plug securely into the electrical outlets. Failure to observe this precaution could result in fire.



- Do not allow the camera to get wet. In addition, do not operate it with wet hands. Failure to observe this precaution could result in electric shocks.



- Do not fire the flash at drivers of vehicles, as this may cause the driver to lose control and result in a traffic accident. Failure to observe this precaution could result in a traffic accident.



- Remove the power plug from the outlets before cleaning the camera.
- Remove the power plug from the outlets when the camera is not used.



- Do not cover the camera while using it. Failure to observe this precaution could result in fire.
- Do not short the terminals or metal contacts on the power cords. Failure to observe this precaution could result in fire.
- Do not use the camera in wet areas or areas subject to oil smoke such as a kitchen. Failure to observe this precaution could result in fire or electric shocks.

**Safety Precautions  
for Accessories**

When using optional products, carefully read the user's manuals provided with the product before using that product.

# Contents

Introduction .....	1
Safety Precautions .....	4
<b>1 Introduction</b> .....	<b>13</b>
Checking the Contents of the Package .....	13
Names and Functions of the Working Parts .....	14
Operating Controls .....	16
Indicators on the Monitor .....	18
Shooting Screen .....	18
Playback Screen .....	19
Changing the Screen Display .....	20
Using the Touch Panel .....	21
How to Change Function Settings .....	22
Using the Button/Lever .....	22
Setting from the Menus .....	25
Menu List .....	27
📷 Still Image Settings Menus .....	27
🎬 Movie Settings Menus .....	30
▶ Playback Settings Menus .....	32
⚙️ Customize Settings Menus .....	33
🔧 Setup Menus .....	35
<b>2 Getting Started</b> .....	<b>37</b>
Setting the Battery and a Memory Card .....	37
Inserting the Battery and a Memory Card .....	37
Charging the Battery .....	38
Initial Settings .....	40
Turning the Camera On .....	40
Setting the Language and the Date and Time .....	41
Formatting a Memory Card .....	42
Basic Shooting Operation .....	44
Shooting in the Program Mode .....	44
Viewing the Captured Images .....	46
<b>3 Taking Pictures</b> .....	<b>48</b>
Taking Still Images .....	48
Setting the Exposure Mode .....	48
Using Exposure Compensation .....	53
Recording Movies .....	54
Playing Back Movies .....	56

Setting the Focus.....	57
Setting the Focus Mode .....	57
Shooting Close-ups (Macro) .....	61
Shooting with a Single Press of the Shutter Release Button (Full Press Snap) .....	62
Setting the Exposure.....	63
Selecting a Metering Method .....	63
Setting the ISO Sensitivity .....	64
Using a Flash.....	65
Reducing Noise .....	67
Setting the White Balance .....	69
Setting the White Balance Manually.....	72
Setting the Color Temperature .....	73
Setting the Drive Mode .....	74
Shooting Continuously (Continuous Shooting) .....	75
Shooting with Varied Exposure Values (Bracketing) .....	76
Shooting While Merging Images Together (Multi-exposure) .....	77
Shooting Automatically at Set Intervals (Interval Shooting) .....	79
Recording Star Trails (Interval Composite) .....	81
Using the Self-timer .....	83
Configuring the Capture Settings .....	84
Image Capture Settings.....	84
Movie Capture Settings.....	85
Setting the Image Finishing Tone and Correction.....	86
Using the ND Filter.....	86
Reducing Moiré (AA Filter Simulator).....	86
Setting the Image Atmosphere (Image Control).....	87
Correcting the Peripheral Illumination.....	89
Correcting a Range of Tones (D-Range Correction) .....	89
Reducing Blurring of Images.....	90
Correcting the Horizontal Camera Angle.....	90

## **4 Playback Functions 91**

Using the Playback Functions.....	91
Changing the Playback Method.....	92
Displaying Multiple Images .....	92
Displaying Rotated Images.....	94
Connecting the Camera to an AV Device.....	95
Organizing Files.....	96
Deleting Files.....	96
Protecting Images from Deletion .....	97
Copying Images and Movies in the Internal Memory to a Memory Card .....	98
Transferring Images .....	99

Editing and Processing Images .....	100
Developing RAW Images .....	100
Changing the Image Size .....	102
Correcting Highlight/Shadow Areas (Levels Adjustment) .....	103
Correcting the White Balance .....	105
Correcting Color Moiré .....	106
Adjusting the Image Quality .....	107
Editing Movies .....	108

## **5 Sharing Images 110**

---

Using the Camera with a Computer .....	110
Using the Camera with a Communication Device .....	111
Connecting to a Communication Device via Bluetooth® .....	112
Enabling the Wireless LAN Function .....	114
Operating the Camera with a Communication Device .....	116

## **6 Changing the Settings 117**

---

Saving Frequently Used Settings .....	117
Saving the Settings .....	117
Assigning Settings to the Mode Dial .....	119
Using the Saved User Mode .....	120
Customizing the Button Functions .....	121
Registering Functions to the ADJ. Mode .....	121
Changing the Functions of the Fn Button .....	123
Setting the Function of the Shutter Release Button .....	125
Display and Sound Settings .....	126
Setting the Information Displayed During Shooting/Playback .....	126
Setting the Instant Review Display .....	127
Setting the Live View Display .....	128
Setting the Brightness and Tone of the Monitor .....	128
Setting the Lamp .....	129
Setting the Sound Effects .....	130
Power Saving Settings .....	131
Automatically Turning the Power Off .....	131
Dimming the Display .....	132
File Management Settings .....	133
Specifying the Folder/File Settings .....	133
Setting the Copyright Information .....	138

Attaching Optional Accessories .....	139
Conversion Lens/Lens Adapter.....	139
AC Adapter.....	140
Troubleshooting .....	141
Power Supply .....	141
Shooting .....	142
Playback/Deletion .....	144
Others .....	145
Error Messages.....	145
Main Specifications.....	147
Camera .....	147
USB Power Adapter AC-U1/AC-U2.....	151
Rechargeable Battery DB-110.....	151
Image Storage Capacity .....	152
Operating Environment .....	153
Using the Camera Abroad .....	154
Precautions for Use .....	155
Camera Care and Storage.....	157
Warranty Policy.....	158
Regulatory Compliance Statements.....	159
Index.....	167

## Checking the Contents of the Package

Before using your digital camera, confirm that the package contains the items listed below.

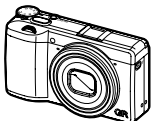

**RICOH GR IIIx**



**Hot shoe cover**

(Installed on the camera)

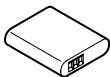

**Rechargeable battery (DB-110)**



**USB power adapter (AC-U1 or AC-U2)\***

\* Differs depending on the region.



**Power plug**

- **USB cable (I-USB166)**
- **Hand strap**
- **Operating Manual (this manual)**

# Names and Functions of the Working Parts

1

Introduction

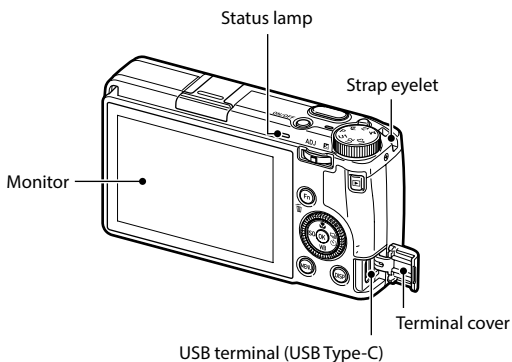
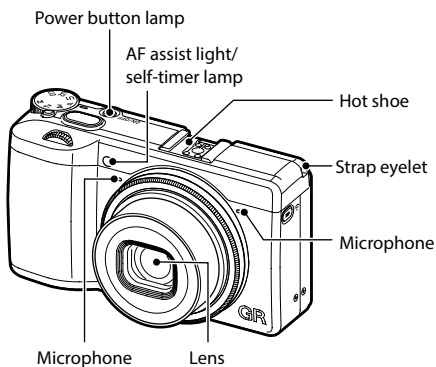



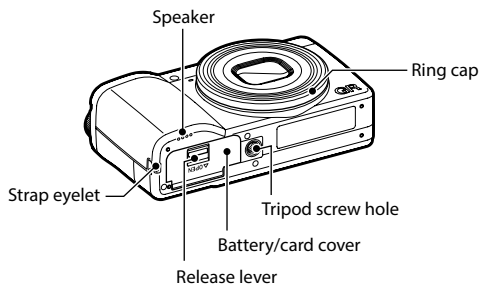

## Operating Controls

This section explains about operating controls.

The icons in parentheses are used in the descriptions of this manual.

1

Introduction

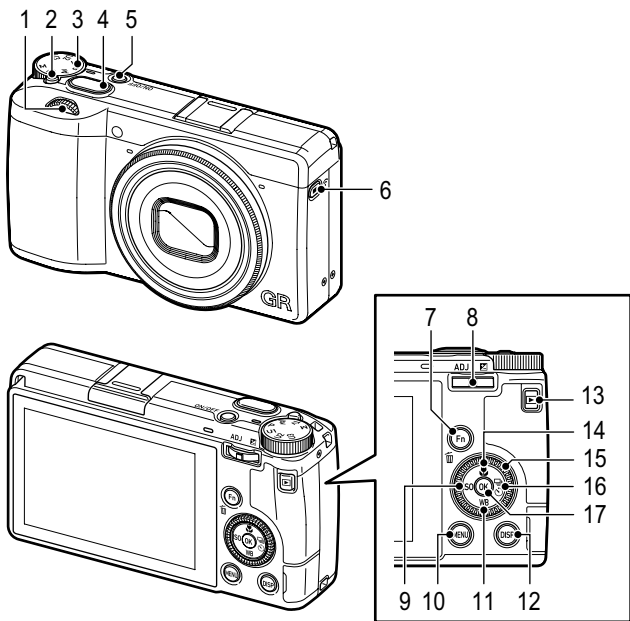

**1 Front e-dial** (🌀)

Rotate the dial to change values for camera settings such as exposure. (p.49)

In the playback mode, rotate the dial to magnify the image or display multiple images at the same time. (p.46, p.92)

**2 Lock button**

Press to allow the mode dial to be turned.













**3 Mode dial**

Changes the exposure mode. (p.48)

**4 Shutter release button** (SHUTTER)

Press to capture images.

Press halfway to activate autofocus. (p.44)

- 5 Power button**  
Turns the power on or off. (p.40)
- 6 Movie/Wireless button (  )**  
Switches between still image mode and movie mode. (p.54)  
Press and hold to turn the wireless LAN function on and off. (p.115)
- 7 Fn/Delete button (  )**  
Calls assigned function. (p.24)  
In the playback mode, press to delete images. (p.46)
- 8 ADJ./EV compensation lever (  )**  
Press the lever to the left or right to change values for camera settings such as exposure.  
In the shooting mode, press to switch to ADJ. mode. (p.23)
- 9 ISO/Left button (  )**  
Press to change the ISO sensitivity. (p.64)  
Moves the cursor to the left when an item is selected.
- 10 MENU button (  )**  
Displays a menu. Press this button while the menu is displayed to return to the previous screen. (p.25)
- 11 White balance/Down button (  )**  
Displays the white balance setting screen. (p.70)  
Moves the cursor down when an item is selected.
- 12 DISP button (  )**  
Switches the display between the shooting information and playback information. (p.20)  
Press and hold this button in shooting mode to magnify the Live View image. (p.45)
- 13 Playback button (  )**  
Switches between the shooting mode and the playback mode. (p.46)
- 14 Macro/Up button (  )**  
Switches to macro mode. (p.61)  
Moves the cursor up when an item is selected.
- 15 Control dial (  )**  
Rotate this dial to change menu items, values for camera settings such as exposure, or images to be displayed on the screen. (p.49)
- 16 Drive/Right button (  )**  
Displays the drive mode setting screen. (p.74)  
Moves the cursor to the right when an item is selected.
- 17 OK button (  )**  
Confirms the selected items such as menus.

# Indicators on the Monitor

## Shooting Screen

1

Introduction

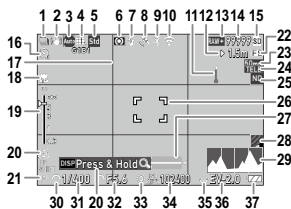

Still image mode

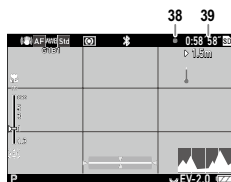

Movie mode

- 1 Drive (p.74)
- 2 Shake Reduction/Movie SR (p.90)/Horizon Correction (p.90)
- 3 Focus (p.57)
- 4 White Balance (p.69)
- 5 Image Control (p.87)
- 6 AE Metering (p.63)
- 7 Flash Mode (p.66)
- 8 GPS positioning status (p.116)\*
- 9 Bluetooth® communication (p.112)
- 10 Wireless LAN communication (p.114)
- 11 Temperature warning
- 12 Snap Focus Distance (p.57)
- 13 File Format/JPEG Recorded Pixels (p.84)
- 14 Number of storable images
- 15 Storage location
- 16 Self-timer (p.83)
- 17 Grid Guide (p.126)
- 18 Macro Mode (p.61)
- 19 Focus bar/Depth of field (p.60)
- 20 Operation guide

- 21 Exposure mode (p.48)
- 22 Full Press Snap (p.62)
- 23 Crop (p.85)
- 24 Conversion lens (p.139)
- 25 ND Filter (p.86)
- 26 Focus frame (p.44)
- 27 Electronic Level (p.126)
- 28 AA Filter Simulator (p.86)
- 29 Histogram (p.126)
- 30 Front e-dial
- 31 Shutter speed (p.49)
- 32 Aperture value (p.49)
- 33 Control dial
- 34 Sensitivity (p.64)
- 35 ADJ./EV compensation lever
- 36 Exposure indicator/Exposure compensation (p.53)
- 37 Battery level (p.19)
- 38 Recording indicator
- 39 Recording time/Remaining recording time

## Playback Screen

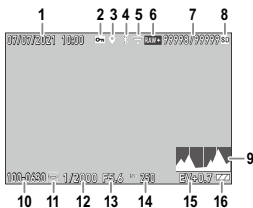

Still image mode

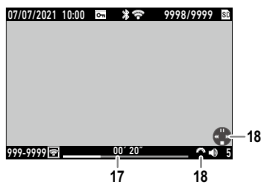

Movie mode

- |    |   |    |   |
|----|---|----|---|
| 1  | Shooting date and time                  | 11 | Image transfer status (p.99)                          |
| 2  | Protect (p.97)                          | 12 | Shutter speed   |
| 3  | GPS information (p.116)*                | 13 | Aperture Value  |
| 4  | Bluetooth® communication (p.112)        | 14 | Sensitivity   |
| 5  | Wireless LAN communication (p.114)      | 15 | Exposure compensation                                 |
| 6  | File Format/JPEG Recorded Pixels (p.84) | 16 | Battery level   |
| 7  | Current file/Total files                | 17 | Length of time of the recorded movie/<br>Elapsed time |
| 8  | Data source                             | 18 | Operation guide                                       |
| 9  | Histogram                               |    |   |
| 10 | Folder number/File number (p.133)       |    |   |



### Memo

- The GPS positioning status (shooting screen item No. 8) and GPS information (playback screen item No. 3) are displayed when [Store Location Info.] is set to [On] in [Smartphone Link] of the 6 menu and the camera is linked with a communication device.

## Battery Level

The icon display changes depending on the battery level.

	The battery level is sufficient.
	The battery level started to drop.
	The battery level is low. Charge the battery.
	The camera will turn off soon.
	There is a problem with the battery.

## Changing the Screen Display

You can switch the information displayed on the screen by pressing **DISP**.

### Shooting Mode

The information displayed on the shooting screen can be switched.

Standard Info. Display	Displays all the information.
Simplified Info. Display	Displays only the information regarding the exposure, AE lock, autofocus frame, and MF operation guide.
No Information Display	Displays the information only when camera settings are changed. Autofocus frame is displayed during range-finding.
Display Off	Does not display the autofocus frame and Live View but the information when the camera settings are changed.



#### Memo

- You can specify the displayed information in [Shooting Info. Display] of the **C** 3 menu. (p.126)

## Playback Mode

You can switch the screen display among [Standard Info. Display], [Detailed Info. Display], and [No Information Display] in the single image display. Use ▲▼ to switch the page in [Detailed Info. Display].

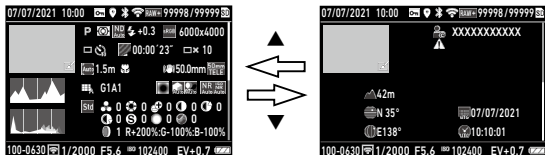

### Memo

- You can specify the displayed information in [Playback Info. Display] of the **C** 3 menu. (p.126)
- [Histogram], [Grid Guide], and [Highlight Alert] are not displayed for movies.

## Using the Touch Panel

You can perform operations such as selecting functions and setting the AF point for shooting with the touch panel.

When not using the touch panel function, set [LCD Touch Operation] to [Off] in the **C** 2 menu.

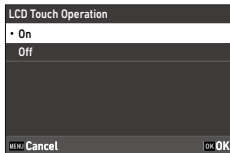

# How to Change Function Settings

## Using the Button/Lever

### Using the Direct Keys

Quick settings are possible by pressing ▲▼◀▶ in the shooting mode. The following functions can be activated.

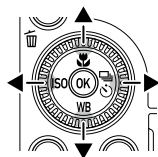

▲ (📷)	Macro Mode (p.61)
▼ (WB)	White Balance (p.69)
◀ (ISO)	ISO Setting (p.64)
▶ (📷)	Drive Mode (p.74)



#### Memo

- The functions mentioned above can be set from the 📷 menu by pressing MENU.
- The functions assigned to ◀/▶ can be changed with [ISO Button] and [Drive Button] of [Fn Button Setting] in the C 2 menu. (p.123)



## Using the ADJ. Lever

The assigned functions can be easily recalled by pressing **ADJ.** in the shooting mode.

### 1 Press **ADJ.** in the shooting mode.

The mode switches to the ADJ. mode and the icons for the assigned functions appear.

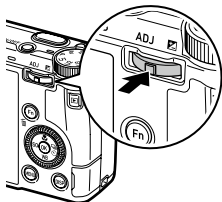

### 2 Use **◀▶** to select a function.

By default, the following functions can be selected.

- Image Control (p.87)
- Focus (p.57)
- AE Metering (p.63)
- File Format (p.84)
- Outdoor View Setting (p.129)



### 3 Use **▲▼** to select a setting.

When making detailed settings, press **Fn.**

### 4 Press **OK.**

The selected function is set and the camera is ready to perform shooting.



#### Memo

- The functions for ADJ. mode can be changed in [ADJ Mode Setting] of the **C 2** menu. (p.121)
- When [Shutter Btn. Confirmation] is set to [On] in the **C 2** menu, pressing **SHUTTER** halfway completes the setting of ADJ. mode. (p.125)

## Using the Fn Button

The assigned function can be activated by pressing **Fn** in the shooting mode. By default, [AF+AE Lock] is assigned.

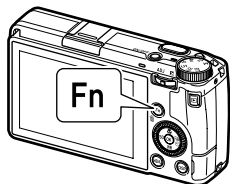

1

Introduction



### Memo

- The function of **Fn** can be changed in [Fn Button Setting] of the **C 2** menu. [ISO Button] (◀), [Drive Button] (▶), and [Movie/Wireless Button] (⏻) can also be set in [Fn Button Setting]. (p.123)
- When the power is turned on or the mode dial is turned, the current function of the button is displayed. If [Guide Display] is set to [Off] in the **2** menu, the function is not displayed.

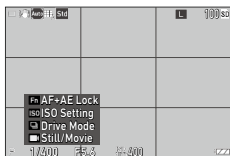

## Setting from the Menu

Most functions are set from the menus.

**1** Press **MENU**.

The 1 menu appears.

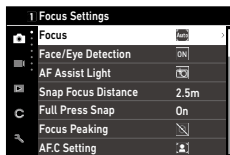

**2** When changing the menu type, press **◀** twice, and then use **▲▼** to select a type.



	Still Image Settings menus (p.27)
	Movie Settings menus (p.30)
	Playback Settings menus (p.32)
	Customize Settings menus (p.33)
	Setup menus (p.35)

**3** Press **▶** twice.

**4** Use **▲▼** to select a function.

Each menu type includes 1 to 11 menus. To switch the screen display on a menu-by-menu basis, press **◀** and then **▲▼**.

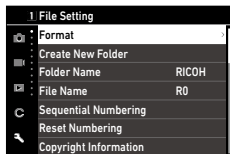

## 5 Find a function to set, and press ►.

The settings for the selected setting item are displayed.

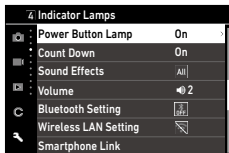

## 6 Use ▲▼ to select a setting, and press OK.

The screen in Step 4 reappears.

Press **MENU** to return to the previous screen.

When you have finished setting, press **MENU** several times to return to previous screens.

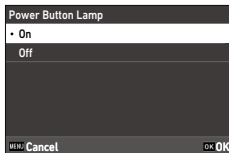

### Memo

- When **MENU** is pressed, the last used menu screen appears first. To display the most appropriate menus for the camera settings at that time, set [Store Cursor Position] to [Off] in the **2** menu.
- ◀ (front e-dial) or ⚙ (control dial) can be turned in place of ▲▼.
- The setting is saved even after the power is turned off. Each menu type can be restored to the default settings in [Reset] of the **11** menu.



# Menu List

The following menus are available. (The underlined settings and the square-bracketed settings are the default settings.)

## Still Image Settings Menus

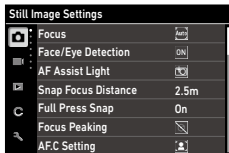

1 Focus Settings		
Focus	<u>Auto-area AF</u> , Select AF, Pinpoint AF, Tracking AF, Continuous AF, MF, Snap, ∞	p.57
Face/Eye Detection	<u>On</u> , Use only in Auto-area AF, Off	p.58
AF Assist Light	<u>On</u> , Off	p.58
Snap Focus Distance	1m, 1.5m, 2m, <u>2.5m</u> , 5m, ∞	p.57
Full Press Snap	<u>On</u> , Off	p.62
Focus Peaking	Highlight Edge, Extract Edge, <u>Off</u>	p.58
A.F.C. Setting	<u>Focus-priority</u> , FPS-priority	p.57
MF Auto Magnification	On, <u>Off</u>	p.60
2 Exposure Setting		
Exposure Mode	Program AE, Aperture Priority AE, Shutter Priority AE, Manual Exposure	p.120
AE Metering	<u>Multi-segment</u> , Center-weighted, Spot, Highlight-weighted	p.63
ISO Setting	ISO Setting: <u>AUTO</u> , 100 to 102400 ISO Auto Upper Limit: From one setting higher than the lowest ISO sensitivity to the highest ISO sensitivity [6400] ISO Auto Lower Limit: From the lowest ISO sensitivity to one setting lower than the highest ISO sensitivity [100] Minimum Shutter Speed: 1 to 1/1000 sec. [1/40]	p.64
Flash Mode	Flash Mode: <u>Flash On</u> , Flash On+Red-eye, Slow-speed Sync, Slow Sync+Red-eye Flash Exposure Comp.: -2.0 to +1.0	p.66

Program Line	<u>Normal</u> , Max Aperture Priority, DOF Priority (Deep)	p.51
ND Filter	<u>Auto</u> , On, Off	p.86
Auto EV Compensation	On, <u>Off</u>	p.49
Link AE and AF Point	On, <u>Off</u>	p.63
<b>📷 3 White Balance Settings</b>		
White Balance	Auto White Balance, <u>Multi Auto White Balance</u> , Daylight, Shade, Cloudy, Fl. - Daylight Color, Fl. - Daylight White, Fl. - Cool White, Fl. - Warm White, Tungsten, CTE, Manual White Balance, Color Temperature	p.69
WB Fine-tuning	On, <u>Off</u>	p.71
AWB in Tungsten Light	<u>High</u> , Low	p.71
<b>📷 4 Shooting Settings</b>		
Still/Movie	<u>Still Image</u> , Movie	p.54
Macro Mode	On, <u>Off</u>	p.61
Drive Mode	Drive: <u>Single Frame Shooting</u> , Continuous Shooting, Bracketing, Multi-exposure, Interval Shooting, Interval Composite Self-timer: 10sec., 2sec., <u>Off</u>	p.74
AA Filter Simulator	High, Low, <u>Off</u>	p.86
<b>📷 5 Image Capture Settings</b>		
File Format	<u>JPEG</u> , RAW, RAW+JPEG	p.84
Aspect Ratio	<u>3:2</u> , 1:1	
Crop	50mm, 71mm, <u>Off</u>	
JPEG Recorded Pixels	<u>L</u> , M, S, XS	
Color Space	sRGB, AdobeRGB	
<b>📷 6 Image Process Settings</b>		
Image Control	<u>Standard</u> , Vivid, Monotone, Soft Monotone, Hard Monotone, Hi-Contrast B&W, Positive Film, Bleach Bypass, Retro, HDR Tone, Cross Processing, Custom 1, Custom 2	p.87
Peripheral Illumin. Corr.	On, <u>Off</u>	p.89
D-Range Correction	Highlight Correction: <u>Auto</u> , On, Off Shadow Correction: <u>Auto</u> , Low, Medium, High, Off	p.89
Noise Reduction	Slow Shutter Speed NR: <u>Auto</u> , On, Off High-ISO Noise Reduction: <u>Auto</u> , Low, Medium, High, Custom, Off	p.67

## 7 Shooting Assist

Shake Reduction	<u>On</u> , <u>Off</u>	p.90
Auto SR Off	<u>Enable Auto SR Off</u> , <u>Disable Auto SR Off</u>	p.90
Horizon Correction	<u>On</u> , <u>Off</u>	p.90

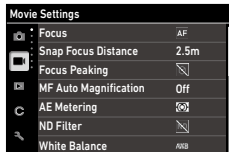

■ 1 Focus Settings		
Focus	AF, MF, Snap, ∞	p.57
Snap Focus Distance	1m, 1.5m, 2m, <u>2.5m</u> , 5m, ∞	p.57
Focus Peaking	Highlight Edge, Extract Edge, Off	p.58
MF Auto Magnification	On, Off	p.60
■ 2 Exposure Setting		
AE Metering	<u>Multi-segment</u> , Center-weighted, Spot, Highlight-weighted	p.63
ND Filter	On, Off	p.86
■ 3 White Balance Settings		
White Balance	<u>Auto White Balance</u> , Daylight, Shade, Cloudy, Fl. - Daylight Color, Fl. - Daylight White, Fl. - Cool White, Fl. - Warm White, Tungsten, CTE, Manual White Balance, Color Temperature	p.69
WB Fine-tuning	On, Off	p.71
AWB in Tungsten Light	<u>High</u> , Low	p.71
■ 4 Shooting Settings		
Still/Movie	Still Image, Movie	p.54
Macro Mode	On, Off	p.61
■ 5 Movie Capture Settings		
Framerate	<u>60p</u> , 30p, 24p	p.85
Sound Recording	On, Off	



■ 6 Image Process Settings		
Image Control	<u>Standard</u> , Vivid, Monotone, Hard Monotone, Hi-Contrast B&W, Positive Film, Bleach Bypass, Retro, Cross Processing, Custom 1, Custom 2	p.87
Peripheral Illumin. Corr.	<u>On</u> , Off	p.89
D-Range Correction	Highlight Correction: <u>Auto</u> , Off Shadow Correction: <u>Auto</u> , Low, Medium, High, Off	p.89
■ 7 Shooting Assist		
Movie SR	<u>On</u> , Off	p.90

## ▶ Playback Settings Menus

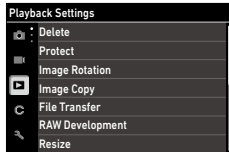

▶ 1 File Management		
Delete	Delete 1 Image, Delete All Images	p.96
Protect	Protect 1 Image, Protect All Images	p.97
Image Rotation	90° (counterclockwise), 180°, 90° (clockwise)	p.94
Image Copy	—	p.98
File Transfer	Transfer 1 Image	p.99
▶ 2 Image Edit		
RAW Development	JPEG Recorded Pixels, Aspect Ratio, Color Space, White Balance, Image Control, Peripheral Illumin. Corr., Sensitivity, High-ISO Noise Reduction, Shadow Correction	p.100
Resize	—	p.102
Cropping	—	p.102
Levels Adjustment	—	p.103
WB Adjustment	—	p.105
Color Moiré Correction	Low, Medium, High	p.106
Base Parameter Adj	Brightness, Saturation, Filter Effect, Hue, Toning, Contrast, Sharpness	p.107
Movie Edit	Cut, Divide	p.108
▶ 3 Playback Settings		
Auto Image Rotation	On, Off	p.94
Playback Order Options	File No., <u>Shooting Date/Time</u>	p.92
Playback Sound Volume	0 to 20 [10]	p.56

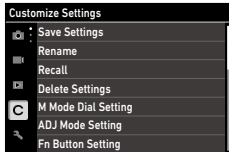











C 1 User Mode		
Save Settings	—	p.117
Rename	—	p.118
Recall	—	p.119
Delete Settings	—	p.118
C 2 Customize Controls		
M Mode Dial Setting	Custom 1, Custom 2	p.52
ADJ Mode Setting	Off, <u>Focus</u> [Setting2], Snap Focus Distance, <u>File Format</u> [Setting4], Aspect Ratio, Crop, JPEG Recorded Pixels, <u>AE Metering</u> [Setting3], ISO Setting, Flash Mode, Flash Exposure Comp., Drive, Self-timer, <u>Image Control</u> [Setting1], One Push AE in M Mode, Touch AF, <u>Outdoor View Setting</u> [Setting5]	p.121
Fn Button Setting	Off, Focus, Set MF, Set Snap, Set Tracking AF, Enable AF, <u>AF+AE Lock</u> [Fn Button], AE Lock, Face/Eye Detection, Snap Focus Distance, File Format, JPEG → RAW, JPEG → RAW+, Aspect Ratio, Crop, JPEG Recorded Pixels, Framerate, <u>Still/Movie</u> [Movie/Wireless Button], AE Metering, <u>ISO Setting</u> [ISO Button], Flash Mode, Flash Exposure Comp., ND Filter, <u>Drive Mode</u> [Drive Button], Drive, Continuous Shooting, Self-timer, Image Control, Shake Reduction, One Push AE in M Mode, 4-way Controller Action, Touch AF, <u>Outdoor View Setting</u> , <u>Wireless LAN Setting</u> [Hold Movie/Wireless Btn.], Preview Focus Settings: <u>Same as Shutter Button</u> , Auto-area AF, Select AF, Pinpoint AF, Tracking AF, Continuous AF Keep AE Lock: On, <u>Off</u> One Push AE in M Mode: Program AE, <u>Aperture Priority AE</u> , Shutter Priority AE	p.123

Shutter Button Setting	<u>AF+AE Lock</u> , AE Lock	p.125
4-way Controller	<u>Direct Key Priority</u> , AF point change Priority	p.59
Shutter Btn. Confirmation	On, <u>Off</u>	p.125
LCD Touch Operation	On, Off	p.21
Touch AF	<u>AF Point</u> , AF Point+Focus, AF Point+Focus+Shoot, Full Press Snap, Off	p.50
<b>C 3 Display Customization</b>		
Shooting Info. Display	Standard Info. Display, Simplified Info. Display, No Information Display, Display Off	p.126
Playback Info. Display	Standard Info. Display, No Information Display	
Instant Review	Display Time: <u>0.5sec</u> , 1sec, 2sec, 3sec., Hold, Off Zoom Review: On, <u>Off</u> Delete: On, <u>Off</u>	p.127
Quick Zoom	x4, x8, x16, <u>100%</u>	p.127
Focus Magnification	On, Off	p.47
Grid Style	<u>3x3 Grid</u> , 4x4 Grid	p.128
Electronic Level Type	<u>Level+Tilt</u> , Level	
Flicker Reduction	<u>50Hz</u> , 60Hz	



<b>1 File Setting</b>		
Format	Memory Card, Internal Memory	p.42
Create New Folder	—	p.133
Folder Name	Folder Name: Date, <u>Optional</u> A freely defined string of characters [RICOH]	p.134
File Name	Still Image: A freely defined string of two characters [R0] Movie: A freely defined string of two characters [R0]	p.136
Sequential Numbering	<u>Folder &amp; File</u> , File, Off	p.137
Reset Numbering	—	p.137
Copyright Information	Embed Copyright Data: <u>On</u> , <u>Off</u> Copyright Information: A freely defined string of 32 characters	p.138
<b>2 Display Settings</b>		
Store Cursor Position	<u>On</u> , Off	p.26
Guide Display	<u>On</u> , Off	p.24
Animation Setting	<u>On</u> , Off	p.47
<b>3 LCD Setting</b>		
LCD Setting	Brightness: -7 to +7 Saturation: -7 to +7 Adjust: Blue-Amber: -7 to +7 Adjust: Green-Magenta: -7 to +7	p.128
Outdoor View Setting	-2 to +2	p.129
<b>4 Indicator Lamps</b>		
Power Button Lamp	<u>On</u> , Off	p.129
Count Down	<u>On</u> , Off	
<b>5 Sound Effects Setting</b>		
Sound Effects	<u>All</u> , Shutter Sound Only	p.130
Volume	0 to 3 [2]	

 6 Wireless Connection		
Bluetooth Setting	Action Mode: On anytime, On when power is on, <u>Disable</u> Pairing Communication Info.	p.112
Wireless LAN Setting	Action Mode: On, <u>Off</u> Communication Info.	p.114
Smartphone Link	Store Location Info.: On, <u>Off</u> Auto Image Transfer: On, <u>Off</u> Auto Resize: On, <u>Off</u> Image Transfer while Off: On, <u>Off</u>	p.116
 7 Power Supply Settings		
Auto Power Off	<u>1min.</u> , 3min., 5min., 10min., 30min., Off	p.131
Sleep Mode	<u>1min.</u> , 3min., 5min., 10min., 30min., Off	p.132
LCD Auto Dim	<u>On</u> , Off	
 8 About This Device		
Firmware Info/Options	—	—
Certification Marks	—	p.2
 9 Sensor Maintenance		
Pixel Mapping	—	p.144
Dust Removal	Execute Dust Removal Startup Action: <u>On</u> , Off Shutdown Action: <u>On</u> , Off	p.144
 10 Language/Date Setting		
Language/言語	<u>English</u> , French, German, Spanish, Portuguese, Italian, Dutch, Danish, Swedish, Finnish, Polish, Czech, Hungarian, Turkish, Greek, Russian, Thai, Korean, Traditional Chinese, Simplified Chinese, Japanese	p.41
Date Adjustment	Date Format: Y/M/D, D/M/Y, M/D/Y Date: 1/1/2021 to 12/31/2070 Time: 00:00 to 23:59	p.41
 11 Reset		
Reset	Reset Item:  ,  ,  ,  ,  Execute Reset	p.26

## Setting the Battery and a Memory Card

### Inserting the Battery and a Memory Card

SD memory cards, SDHC memory cards, and SDXC memory cards can be used with this camera. "Memory card" refers to these memory cards in this manual.

**1** Make sure that the camera power is off.

**2** Slide the release lever on the bottom of the camera toward OPEN to open the battery/card cover.

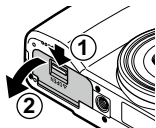

**3** Make sure that the memory card is facing the right way and then push the card all the way in until it clicks.

To remove it, press in the memory card and then release your hand.

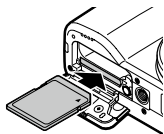

**4** Insert the battery.

Use the battery to press the latch and insert the battery all the way into the battery compartment.

To remove the battery, slide the latch.

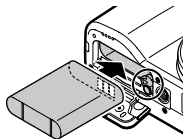

**5** Close the battery/card cover and slide the release lever in the opposite direction of OPEN to lock it in place.

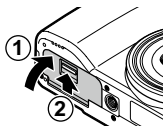

## Data Storage Location

Images taken and movies recorded with this camera are saved in the internal memory or a memory card.



### Memo

- You can copy all data stored in the internal memory to a memory card. (p.98)
- The storage capacity varies depending on the memory card. (p.152)

2

Getting Started

## Charging the Battery

Charge the rechargeable battery DB-110 using the provided USB cable I-USB166, USB power adapter AC-U1/AC-U2, and power plug before use.

1

### Insert the power plug to the USB power adapter.

Insert it until it clicks into place.

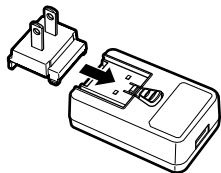

2

### Open the terminal cover, and connect the USB cable to the USB terminal.

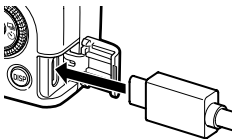



**3** Connect the USB cable to the USB power adapter.

**4** Plug the USB power adapter into a power outlet.

The status lamp of the camera turns on and charging starts.

Depending on the battery level, the charging time differs. An exhausted battery will be fully recharged in about 2.5 hours (at 25°C (77°F)).

When charging is complete, the status lamp turns off.

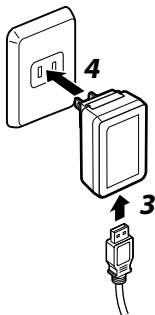

**5** Remove the USB cable from the USB terminal, and close the terminal cover.



#### Storage Capacity

- About 200 pictures can be taken when the battery is fully charged.
- This is based on tests conducted according to CIPA standards under the following conditions: At 23°C (73°F) temperature; the monitor is on; a picture is taken every 30 seconds; the camera is turned off and back on after 10 pictures are taken.
- The storage capacity is for reference. For long periods of use, it is recommended that you carry spare batteries.



#### Caution

- Use only genuine rechargeable battery (DB-110).
- If the battery starts to run down more quickly even after being charged, the battery has reached the end of its service life. In this case, replace the battery with a new one.
- The battery may become very hot immediately after operation. Turn the camera off and leave it to cool down sufficiently before removing the battery.
- If you turn the camera on while charging the battery, the charging is interrupted.



#### Memo

- You can also charge the battery by connecting the camera to a computer using the USB cable. (p.110)
- The battery can also be recharged with the optional battery charger BJ-11.



## Setting the Language and the Date and Time

You can set the display language for menus and the date and time.

- 1 Use ▲▼ to select a language, and press **OK**.

The selected language is set and the [Date Adjustment] screen appears.

- 2 Set the display format and the date and time.

Use ◀▶ to select an item and ▲▼ to change the value.

Press **MENU** to cancel the setting.

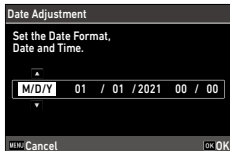

- 3 Press **OK**.

The date and time are set and the camera is ready to take a picture.



### Memo

- If the battery is removed for about five days, the date and time settings will be lost. To retain the date and time settings, insert a battery with sufficient power for at least two hours, and then remove the battery.
- You can change the language and the date and time settings in the  10 menu.

## Formatting a Memory Card

When using a new memory card or a memory card used with another device, be sure to format the memory card with this camera. The internal memory can also be formatted with the same operations.

2

Getting Started

**1** Press **MENU**.  
The menu appears.

**2** Press **◀** twice, and then use **▲▼** to select **⌂**.



**3** Press **▶** twice, select [Format], and press **▶**.

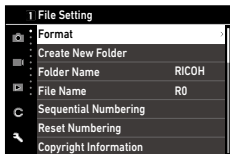

**4** Use **▲▼** to select [Memory Card] or [Internal Memory], and press **▶**.  
The confirmation screen appears.

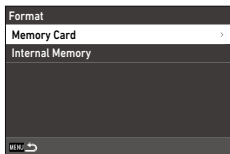

**5** Use **▲** to select [Execute], and press **OK**.  
The memory is formatted and the screen in Step 4 reappears.

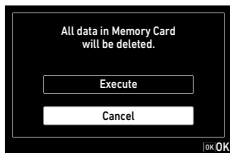

**6** Press **MENU** twice.  
The shooting screen reappears.

**Caution** -----

- Do not remove the memory card while formatting, or the card may be damaged.
- Formatting deletes all data, both protected and unprotected.

**Memo** -----

- When a memory card is formatted, the volume label "RICOH GR" is assigned to the card.

# Basic Shooting Operation

## Shooting in the Program Mode

- 1** Set the mode dial to **P** while pressing the lock button.

The exposure mode is set to [Program AE] and the Live View is displayed.

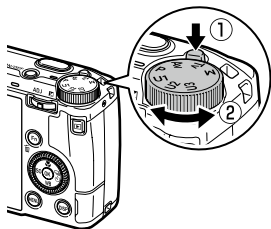

- 2** Press **SHUTTER** halfway.

Focus is adjusted, and exposure is set.

The distance is measured from up to 25 points and the green focus frame appears for the area in focus.

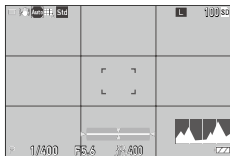

- 3** Press **SHUTTER** fully.

The image you have just taken is displayed on the monitor (Instant Review) and saved.



### Focus

- The status lamp and the frame color show whether the subject is in focus.

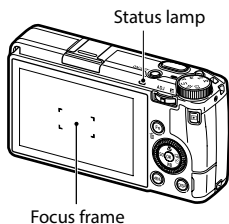

Focus Status	Frame Color	Status Lamp
Before focusing	White	Off
Subject in focus	Green	Green (on)
Unable to focus	Red	Green (blinks)

**Magnifying Live View image**-----

- The Live View image can be magnified.  
The following operations are available.

Press and hold <b>DISP</b>	Magnifies the Live View image.
	Switches the magnification between [x4] and [x16].
	Moves the magnified area.
<b>OK</b>	Resets to the entire image display.

- The image cannot be magnified during recording in mode.

**Memo**-----

- You can set the display and operation of [Instant Review] that displays the captured image immediately after shooting in the **C** 3 menu. (p.127)

## Viewing the Captured Images

Review the captured image on the monitor.

### 1 Press .



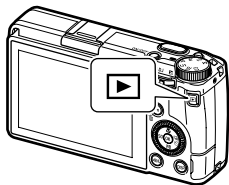



The camera switches to the playback mode and the last image you took is displayed. (Single image display)



### 2 View an image.



The following operations are available.

 /Flick	Displays the previous or next image.
	Deletes the image. (p.96)
 to the right/Pinch out	Magnifies the image.
 to the left/Pinch in	In magnified view: Reduces the image.
 /Slide	In magnified view: Moves the magnified area.
Press <b>ADJ</b> /Double-tap	Magnifies the image with the magnification ([x4], [x8], [x16], [100%]) set in [Quick Zoom] of the <b>C</b> 3 menu. (p.127) In magnified view: Returns to the single image display.
<b>ADJ</b> to the left or right/ 	Displays the previous or next image. In magnified view: Displays the previous or next image without changing the magnification.
<b>DISP</b>	Switches between [Standard Info. Display], [Detailed Info. Display], and [No Information Display]. In magnified view: Switches between [Standard Info. Display] and [No Information Display].
	Displays the playback functions setting screen. (p.91)





## Memo

---

- If [Focus Magnification] is set to [On] (default setting) in the **C** 3 menu, the image is magnified centering on the AF point set in shooting.
- Movies cannot be magnified.
- If the image is switched to the previous or next image by flicking on the touch panel, animation is displayed. The function can be set to [Off] in [Animation Setting] of the **2** menu.

## Taking Still Images

### Setting the Exposure Mode

Set an aperture value or shutter speed for shooting. The following settings can be set.

✓ : Available # : Conditionally available

Exposure Mode	Aperture Value	Shutter Speed	Sensitivity
<b>P</b> Program AE	#*1	#*1	✓
<b>Av</b> Aperture Priority AE	✓	Automatically set	✓
<b>Tv</b> Shutter Priority AE	Automatically set	✓	✓
<b>M</b> Manual Exposure	✓	✓	✓

\*1 The Program Shift allows you to select the combination of aperture value and shutter speed.

### 1 Set the mode dial to **P**, **Av**, **Tv**, or **M**.



The exposure mode and set value are displayed on the shooting screen.

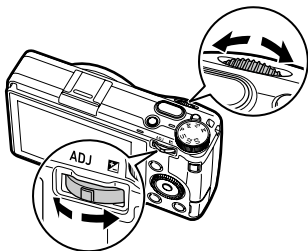

- 2** Turn  or **ADJ** to change a value.



The following settings can be changed.

Exposure Mode		Turn <b>ADJ</b> to the Left or Right (  )
<b>P</b>	Program shift	Exposure compensation
<b>Av</b>	Aperture value	Exposure compensation
<b>Tv</b>	Shutter speed	Exposure compensation
<b>M</b>	Aperture value	Shutter speed

In **M** mode, the exposure indicator is displayed. As a guide, the exposure is correct when the exposure indicator is in the center. When the exposure value is in the range of  $\pm 2$  EV, the indicator changes according to the exposure value. The indicator turns yellow when the values are outside this range.

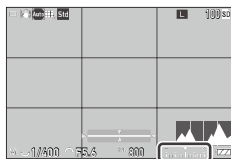

When the ISO sensitivity is set to ISO AUTO, the exposure compensation can be adjusted using .

### **3** Shoot.



#### **Memo** -----

- If [Auto EV Compensation] is set to [On] in the  2 menu, the exposure is automatically compensated when the correct exposure cannot be achieved in **Av** or **Tv** mode.
- Pressing **SHUTTER** halfway activates the autofocus and AE Lock. To activate only the AE Lock, set [Shutter Button Setting] to [AE Lock] in the **C** 2 menu. (p.125)

**Caution**

- Images are not displayed on the monitor during shooting.

**AE Lock**

- The exposure value is locked while **SHUTTER** is pressed halfway, and the lock is canceled when the button is released.
- [AF+AE Lock] or [AE Lock] can be registered to [Fn Button Setting] in the **C 2** menu to use the function with **Fn**. By default, [AF+AE Lock] is assigned to **Fn**. (p.123)

AF+AE Lock	Locks the focus and exposure value. The lock is canceled when the button is released.
AE Lock	When [Keep AE Lock] is set to [On] in [Fn Button Setting] of the <b>C 2</b> menu, the AE lock is kept if the button is released.

- If the sensitivity is fixed at a certain sensitivity in **M** mode or if the shutter speed is set to [B], [T], or [BT], the AE lock function is not available.

**AF Using the Touch Panel**

- By default, only the AF point can be changed using the touch panel. To perform autofocus and shooting using the touch panel, set [Touch AF] in the **C 2** menu.

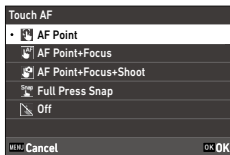

AF Point	Sets the AF point to the touched point.
AF Point+Focus	Sets the AF point to the touched point and performs autofocus.
AF Point+Focus+Shoot	Sets the AF point to the touched point, performs autofocus, and shoots.
Full Press Snap	Performs shooting with "Full Press Snap".
Off	Does not use the touch AF.

When the touch AF is activated in **MF** mode, autofocus is performed with [AF Point+Focus].



### Program Line

- You can set the program line for **P** mode to [Max Aperture Priority] or [DOF Priority (Deep)] in [Program Line] of the **C2** menu.



### Bulb, Time, and Bulb Timer



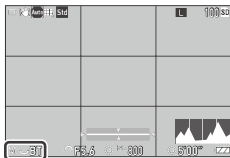

- If the sensitivity is fixed at a certain sensitivity in **M** mode, [B], [T], or [BT] can be set for the shutter speed.



Shutter Speed	Operation
<b>B</b> Bulb	Exposure is continued while <b>SHUTTER</b> is pressed, and canceled when the button is released.
<b>T</b> Time	Exposure is started when <b>SHUTTER</b> is pressed, and ended when the button is pressed again.
<b>BT</b> Bulb timer	Exposure is started when <b>SHUTTER</b> is pressed, and ended after the set time has elapsed. Set the exposure time using  .

- [B] and [T] are available when [Drive Mode] is set to [Single Frame Shooting] or [Multi-exposure], and [BT] is available when [Drive Mode] is set to [Single Frame Shooting], [Multi-exposure], [Interval Shooting], or [Interval Composite].
- Operation is also possible using the optional cable switch (CA-3) in place of **SHUTTER**. When using the cable switch, connect it to the camera with the provided USB cable.
- [One Push AE in M Mode] in [Fn Button Setting] of the **C2** menu does not work.

**Preview**

- When [Hold Movie/Wireless Btn.] is set to [Preview] in [Fn Button Setting] of the **C 2** menu, the Preview is available. (p.123) If you press and hold , the aperture is adjusted to the set aperture value, and you can check the depth of field. It is canceled when  is released.
- When [Hold Movie/Wireless Btn.] is set to [Wireless LAN Setting] (default setting),  works as the switch to turn on/off the wireless LAN function. In this case, the Preview is not available.
- In the Preview mode, you cannot perform shooting and change the aperture value.
- When using the flash, the actual aperture value may differ from the Preview.
- The Preview is used for checking the depth of field, so it may not function properly with AE.
- This function is not available in  mode.

**Functions in M Mode**

- The functions for  and **ADJ** in **M** mode can be switched in [M Mode Dial Setting] of the **C 2** menu.
- When [One Push AE in M Mode] is registered in [Fn Button Setting] (p.123) of the **C 2** menu, you can select the priority of values for when the button is pressed,.

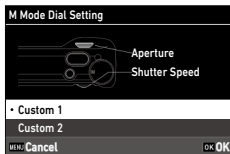

Program AE	Adjusts both the aperture value and shutter speed.
Aperture Priority AE	Sets the aperture value to a fixed value and adjusts the shutter speed.
Shutter Priority AE	Sets the shutter speed to a fixed value and adjusts the aperture value.

When the ISO sensitivity is set to ISO AUTO or the shutter speed is set to [B], [T], or [BT], [One Push AE in M Mode] does not work.

## Using Exposure Compensation

### 1 Press **ADJ** ( ) to the left or right.

The value will be plus (+) when the button is pressed to the right, and minus (-) when it is pressed to the left.

In **M** mode, turn .

Settings can be made in the range of  $\pm 5.0$  EV ( $\pm 2.0$  EV in  mode) in increments of 1/3 EV steps.

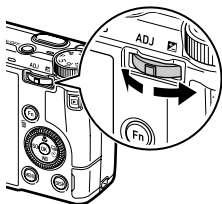



### Caution

- Exposure compensation is not available when the sensitivity is fixed at a certain sensitivity in **M** mode.

# Recording Movies

## 1 Press .

The camera enters  mode.

You can switch the camera to the movie mode also from [Still/Movie] of the  4/ 4 menu.



## 2 Focus on the subject.

When [Focus] is set to [AF], press **SHUTTER** halfway.

## 3 Press **SHUTTER** fully.

Recording starts.

The recording time is displayed while recording.

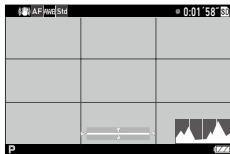



## 4 Press **SHUTTER** again.

Recording stops.



### Caution

- When [Sound Recording] is set to [On] (default setting) in the  5 menu, camera operation sounds are also recorded.
- If the internal temperature of the camera becomes high during recording, recording may be terminated.
- The following functions cannot be used in  mode.
  - Flash
  - Wireless LAN





## Memo

---

- Movies are recorded in **P** mode regardless of the mode dial setting. Exposure compensation is possible.
- When [Touch AF] is activated in the **C 2** menu, autofocus can be performed using the touch panel even while recording movies.
- You can record a movie continuously up to 4 GB or 25 minutes. Recording stops when the memory card or internal memory becomes full. The maximum recording time per shooting depends on the capacity of the memory card. (p.152) Shooting may stop even before the maximum recording time is reached.
- The amount of time remaining is calculated based on the amount of memory available and may not diminish at an even rate.
- Use a memory card of Speed Class 6 or higher for recording movies.
- The use of the battery with sufficient power or the optional AC adapter (D-AC166) is recommended.

## Playing Back Movies

### 1 Press .







An image is displayed in the single image display of playback mode.

### 2 Use to select a movie to play back.

The first frame of the movie is displayed as a still image.



### 3 Play back a movie.



 / Tap	Plays back/Pauses a movie.
 / Double-tap	Stops playback.
	Adjusts the sound volume (0 to 20).
 / 	During playback: Fast-reverses/Fast-forwards playback. While playback is paused: Reverses/Forwards a frame.
	While playback is paused: Saves a still image as a JPEG file.
	Switches between [Standard Info. Display] and [No Information Display].















#### Memo

- The sound volume at the start of movie playback can be set in [Playback Sound Volume] of the  3 menu.
- In [Movie Edit] of the  2 menu, a movie file can be divided into multiple segments or clipped. (p.108)

## Setting the Focus

### Setting the Focus Mode

 Auto-area AF	Measures the distances from 5 × 5 AF areas and focuses to the optimum AF area. (Default setting)
 Select AF	Focuses to the selected AF areas. (p.59)
 Pinpoint AF	Focuses on a smaller area than [Select AF]. (p.59)
 Tracking AF	Tracks the subject and continually focuses. (p.59) When <b>SHUTTER</b> is pressed halfway, the subject inside the frame in the center of the monitor is set as the target to be tracked, and a green target symbol appears. When a tracking target cannot be found, the frame turns red.
 Continuous AF	Keeps focusing while <b>SHUTTER</b> is pressed halfway. (p.59) [Focus-priority] or [FPS-priority] can be set in [AFC Setting] of the  1 menu.
 MF	Focuses manually. (p.60)
 Snap	Fixes the focus to the set distance. Set a distance in [Snap Focus Distance] of the  1 menu. Turn  while pressing  to change the set distance.
 ∞	Fixes the focus distance at infinity. This is useful for shooting distant scenes.

**1** Select [Focus] in the 1/ 1 menu, and press .

**2** Use to select a setting.

In mode, select from [AF], [MF], [Snap], and [∞].

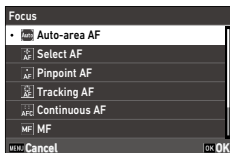

**3** Press .

**4** Press .

The focus mode icon appears on the shooting screen.

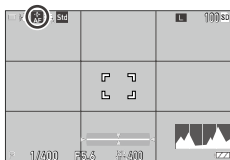

#### Memo

- This function can be registered to [ADJ Mode Setting] or [Fn Button Setting] of the 2 menu. (p.121, p.123)  
If [Set MF], [Set Snap], or [Set Tracking AF] is set to [Fn Button Setting], the focus modes can be switched with button operation only.
- When [Auto-area AF], [Select AF], or [Pinpoint AF] is set, faces and eyes of people are automatically detected. The setting can be changed to [Use only in Auto-area AF] or [Off] in [Face/Eye Detection] of the 1 menu.
- When [Auto-area AF], [Select AF], or [Pinpoint AF] is set, the AF assist light on the front of the camera lights as necessary. The AF assist light can be set to [Off] in [AF Assist Light] of the 1 menu.
- When [Focus Peaking] is set to [Highlight Edge] or [Extract Edge] in the 1/ 1 menu, the outline of the subject in focus is emphasized, and this makes it easier to check the focus.
- By default, the autofocus works with . The action of can be set in [Focus Settings] of [Fn Button Setting] in the 2 menu. (p.124)



#### Caution

- When [Shutter Button Setting] is set to [AE Lock] in the 2 menu, the autofocus does not work when is pressed halfway. (p.125)

## Selecting the Desired AF Point

**1** Set [Select AF], [Pinpoint AF], [Tracking AF], or [Continuous AF] in [Focus] of the 1 menu.

**2** Press **OK** on the shooting screen.  
The AF point can be changed.

**3** Use **▲▼◀▶** to set an AF point.  
Press and hold **OK** to reset the AF point to the center.

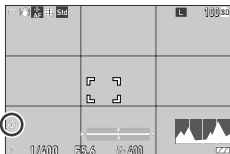

**4** Press **OK**.  
The AF point is set.



- Memo** -----
- When [4-way Controller] is set to [AF point change Priority] in the 2 menu, the AF point can be moved using **▲▼◀▶** without pressing **OK**. In this case, the button functions are as follows.

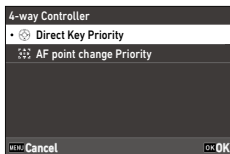

<b>OK</b>	Resets the AF point to the center.
Press and hold <b>OK</b>	Switches between the AF point setting by <b>▲▼◀▶</b> and the direct functions (  ).

## Focusing Manually (Manual Focus)

If the camera fails to focus automatically, you can focus manually. The manual focus enables shooting at a fixed distance.

**1** Set [MF] in [Focus] of the 1/ 1 menu.

The focus bar appears on the shooting screen.

**2** Press .

appears on the focus bar.

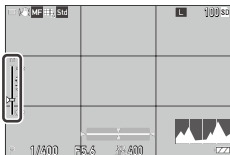

**3** Use to set a focus distance.



*Memo* -----

- If [MF Auto Magnification] is set to [On] in the 1/ 1 menu, the image on the shooting screen is automatically magnified. This makes it easier to focus.

## Shooting Close-ups (Macro)

The camera focuses to the range of 12 to 24 cm from the front edge of the lens.

### 1 Press $\blacktriangle$ ( ) in the shooting mode.

The camera enters the macro mode and the macro icon appears on the shooting screen.

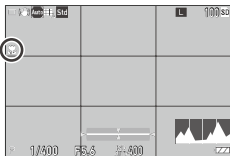



### 2 Shoot.

To cancel the macro mode, press  $\blacktriangle$  again.





#### Memo

- The macro mode can be set to [On] or [Off] in [Macro Mode] of the 4/4 menu.
- When [Focus] is set to [Snap] or [ $\infty$ ], [Select AF] is applied.



#### Caution

- When [Focus] is set to [MF], pressing  $\blacktriangle$  enables focus distance adjustment. (p.60) To enter the macro mode, set [Macro Mode] in the 4/4 menu.

## Shooting with a Single Press of the Shutter Release Button (Full Press Snap)

While pressing **SHUTTER** halfway operates autofocus, pressing **SHUTTER** fully quickly performs shooting at the set focal distance. This function is called “Full Press Snap”. The camera focuses at the distance set in [Snap Focus Distance] of the 1/ 1 menu.

Set [Full Press Snap] of the 1 menu.

When set to [On], the icon and shooting distance are displayed on the shooting screen.



On	Performs shooting by focusing at the distance set in [Snap Focus Distance] when <b>SHUTTER</b> is fully pressed.
Off	Performs autofocus and then shooting.



### Caution

- “Full Press Snap” is not available in the following cases.
  - mode
  - Macro mode
  - When [Focus] is set to [MF], [Snap], or [ $\infty$ ]
  - When [Drive Mode] is set to [Self-timer]



### Memo

- Even when [Full Press Snap] is set to [On], the camera focuses at the setting in [Focus] when **SHUTTER** is pressed halfway.



## Setting the Exposure

### Selecting a Metering Method

Set the metering method in [AE Metering] of the 2/2 menu.



	Multi-segment	Meters exposure in multiple areas of the frame. When a face or eyes are detected with [Face/Eye Detection] enabled, the exposure is adjusted for the face.
	Center-weighted	Meters exposure with emphasis on the center.
	Spot	Meters exposure within a narrow range. Use this option when metering exposure in a part of an image or when the metering target subject is small.
	Highlight-weighted	Meters exposure in multiple areas of the frame with emphasis on the bright areas.



#### Memo

- This function can be registered to [ADJ Mode Setting] of the 2 menu. (p.121)
- When [Link AE and AF Point] is set to [On] in the 2 menu, the metering point and the AF point can be linked in the following combinations of the [AE Metering] and [Focus] settings.

AE Metering	Focus
Multi-segment	[Select AF], [Pinpoint AF], [Tracking AF], or [Continuous AF]
Spot	[Select AF], [Pinpoint AF], or [Continuous AF] When a face or eyes are detected with [Face/Eye Detection] enabled, the exposure is adjusted for the face.

## Setting the ISO Sensitivity

**1** Press **◀** (**ISO**).

**2** Use **⦿** to change the value.

Values from ISO 100 to ISO 102400 can be set.

Press **Fn** to reset to ISO AUTO. Press **Fn** again to reset to the value set last.

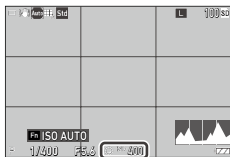

3

Taking Pictures



### Memo

- This function can be set to [ADJ Mode Setting] of the **C 2** menu. (p.121)
- Images taken with a higher sensitivity may appear grainy.
- Depending on the ISO sensitivity setting, the setting of [D-Range Correction] in the **6** menu is disabled. (p.84)
- ISO sensitivity can also be set in [ISO Setting] of the **2** menu. The detailed settings of ISO AUTO can be set from the menu.

ISO Setting	
ISO Setting	AUTO
ISO Auto Upper Limit	6400 >
ISO Auto Lower Limit	100
Minimum Shutter Speed	1/40
MENU →	

ISO Auto Upper Limit	Select the highest ISO sensitivity for ISO AUTO.
ISO Auto Lower Limit	Select the lowest ISO sensitivity for ISO AUTO.
Minimum Shutter Speed	Select the shutter speed to increase the sensitivity for ISO AUTO.

- When the setting of [ISO Button] has been changed in [Fn Button Setting] (p.123) of the **C 2** menu, set in the **2** menu.

## Using a Flash

When a flash unit (optional) is connected to the camera, you can discharge a flash for shooting.

The following flash units can be used.

- PENTAX AF540FGZ, PENTAX AF540FGZ II
- PENTAX AF360FGZ, PENTAX AF360FGZ II
- PENTAX AF201FG

### Connecting a Flash Unit

- 1** Remove the hot shoe cover from the camera.

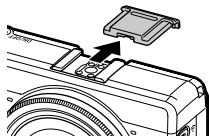

- 2** Turn the camera and the external flash unit off and attach the flash unit to the camera hot shoe.

- 3** Turn the camera and the external flash unit on.



#### Caution





- Turn the external flash unit off before removing it from the camera.
- If the external flash unit is not recognized by the camera, turn the camera and external flash unit off and then remove and reattach the flash.



#### Using Other External Flash Units

- Use only flash units with one signal terminal, which must be an X-contact with a positive voltage of no more than 20 V.
- When other external flash units are used, you cannot set the flash mode. The flash always operates with [Flash On].
- A flash signal is output to the X-contact of the hot shoe regardless of the flash setting.
- Use an external flash unit with a lighting angle that covers the angle of view of the shooting lens.

## Setting the Flash Mode

 Flash On	Always fires the flash. (Default setting)
 Flash On+Red-eye	Forces the flash to fire while reducing the red-eye phenomenon.
 Slow-speed Sync	Fires the flash with the shutter speed slowed. Use when taking nightscape pictures that include people. Use of a tripod is recommended to prevent blur.
 Slow Sync+Red-eye	Fires the flash with the shutter speed slowed while reducing the red-eye phenomenon.

- 1 Select [Flash Mode] in the  2 menu, and press **▶**.
- 2 Select [Flash Mode], and press **▶**.
- 3 Use **▲▼** to select a flash mode, and press **OK**.

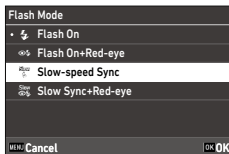

- 4 To compensate the flash exposure, select [Flash Exposure Comp.], and press **▶**.
- 5 Select a compensation value, and press **OK**.

Settings can be made in the range from -2.0 to +1.0.

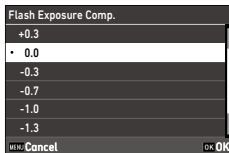

- 6 Press **MENU** twice.



### Caution

- In **Tv** and **M** modes, [Slow-speed Sync] and [Slow Sync+Red-eye] cannot be selected.

## Reducing Noise

### Slow Shutter Speed Noise Reduction

Using a long shutter speed results in a noisy image. When [Slow Shutter Speed NR] is set in the 6 menu, noise reduction processing is carried out.

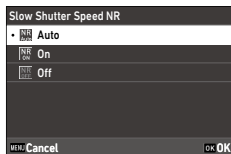

Auto	Applies the noise reduction according to the shutter speed, sensitivity, and internal temperature of the camera.
On	Applies the noise reduction when the shutter speed is slower than 1 second.
Off	Does not apply the noise reduction at any ISO setting.

The status lamp blinks while the processing of [Slow Shutter Speed NR] is being performed.

### High-ISO Noise Reduction

You can reduce the amount of noise when image are taken with a higher sensitivity.

- 1 Select [High-ISO Noise Reduction] in [Noise Reduction] of the 6 menu, and press **▶**.

The [High-ISO Noise Reduction] screen appears.

- 2 Use **▲▼** to select a setting, and press **OK**.

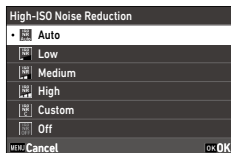

Auto	Automatically reduces noises according to the ISO sensitivity.
Low, Medium, High	Applies Noise Reduction at constant chosen level throughout ISO range.
Custom	The Noise Reduction level can be set for each ISO setting.
Off	Does not apply Noise Reduction at any ISO setting.

The [Noise Reduction] screen appears.

When [Custom] is selected, proceed to the next step.

When other settings are selected, proceed to Step 5.

### 3 Select [Custom Options], and press ►.

The ISO sensitivity setting screen appears.

### 4 Use ▲▼ to select an ISO sensitivity and ◀▶ to select a level.

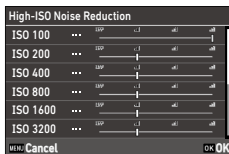

### 5 Press OK.

### 6 Press MENU twice.













### ⚠ Caution -----

- When noise reduction is set, it may take longer than normal to save images.

## Setting the White Balance

Make adjustments to the white balance so that white subjects will appear white under any kind of light.

If the white balance is not how you thought it would be when shooting an object of a single color or when shooting under multiple light sources, change the setting.

 Auto White Balance	Adjusts the white balance automatically.
 Multi Auto White Balance	Automatically optimizes the white balance to match each of the separate areas of light even when multiple light sources are mixed together, such as sunlight and flash. This cannot be selected in  mode.
 Daylight	Used when shooting in daylight under clear skies.
 Shade	Used when shooting in shade.
 Cloudy	Used when shooting in daylight under cloudy skies.
 Fl. - Daylight Color	Used with daylight fluorescent lighting.
 Fl. - Daylight White	Used with neutral white fluorescent lighting.
 Fl. - Cool White	Used with cool white fluorescent lighting.
 Fl. - Warm White	Used with warm white fluorescent lighting.
 Tungsten	Used with incandescent lighting.
 CTE	Exaggerates the color of the light source to leave the color of the subject. Use this setting when you want to emphasize the color used for most part of the image.



Manual White Balance

Set the white balance manually. (p.72)



Color Temperature

Set the color temperature between 2500 to 10000 K. (p.73)

# 1 Press **WB** (▼) in the shooting mode.

The [White Balance] screen appears.

# 2 Use ▲▼ to select a setting.

If no compensation is required, proceed to Step 6.

Refer to p.72 for details on [Manual White Balance] and p.73 for [Color Temperature].

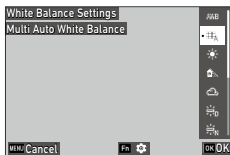

# 3 Press **Fn**.

# 4 Use ▲▼◀▶ to fine-tune the color.



# 5 Press **OK**.

The screen in Step 2 reappears.



## 6 Press **OK**.

The white balance icon appears on the shooting screen.



### Memo

- The white balance can also be set in [White Balance] of the 3/ 3 menu.
- When [Composite Mode] is set to [Average] in [Multi-exposure] of [Drive Mode] (p.77), [Auto White Balance] is applied even if [Multi Auto White Balance] is set.
- To automatically adjust the white balance when the light source is specified, set [WB Fine-tuning] to [On] in the 3/ 3 menu.
- You can set the tungsten light color tone for [Auto White Balance] in [AWB in Tungsten Light] of the 3/ 3 menu.



### Caution

- The white balance may not be adjusted correctly for a subject that is mostly dark.
- When using a flash, set the white balance to [Auto White Balance], [Multi Auto White Balance], or [Manual White Balance]. The white balance may not be adjusted correctly for other settings.

## Setting the White Balance Manually

- 1** Select [Manual White Balance] in Step 2 on p.70.
- 2** Aim the camera at a white subject, such as a sheet of paper, under the light for shooting.
- 3** Press **DISP**.  
An image to be used for white balance adjustment is taken.
- 4** Use **▲▼◀▶** to adjust the point.

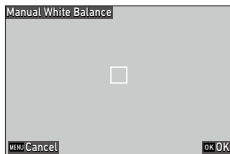

- 5** Press **OK**.  
The [White Balance] screen reappears.
- 6** Press **OK**.  
The shooting screen reappears.

## Setting the Color Temperature

- 1** Select [Color Temperature] in Step 2 on p.70, and press ►.  
The [Color Temperature] screen appears.

- 2** Use ▲▼ to set a value.

The color temperature can be set between 2500 to 10000 K in increments of 10 K.

Press **DISP** to fine-tune the color.

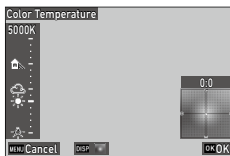

- 3** Press **OK**.

The [White Balance] screen reappears.

- 4** Press **OK**.

The shooting screen reappears.

## Setting the Drive Mode





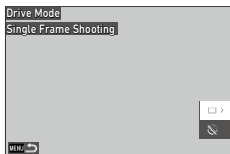

**1** Press  (▶) in the shooting mode.  
The [Drive Mode] screen appears.

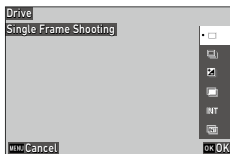
**2** Press ▶.  
The [Drive] screen appears.  
For [Self-timer], refer to p.83.



**3** Use ▲▼ to select a drive mode.



 Single Frame Shooting	Takes a single picture per shooting.	—
 Continuous Shooting	Performs continuous shooting while <b>SHUTTER</b> is pressed.	p.79
 Bracketing	Takes three images with different exposure settings.	p.76
 Multi-exposure	Takes images while merging them together.	p.77
 Interval Shooting	Takes pictures automatically at a fixed interval.	p.79
 Interval Composite	Merges a series of images taken continuously in such a way that the bright areas remain. Use this function when you want to record the trails of light formed by stars or the moon during nightscape shooting at a fixed position.	p.81

## 4 Press **OK**.

The drive mode icon appears on the shooting screen.

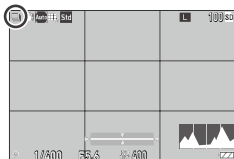

### Memo

- The drive mode can also be set in [Drive Mode] of the 4 menu.

## Shooting Continuously (Continuous Shooting)

1 Select [Continuous Shooting] in Step 3 on p.74.

2 Press and hold **SHUTTER** on the shooting screen.

Pictures continue to be taken as long as you hold down **SHUTTER**.

## Shooting with Varied Exposure Values (Bracketing)

- 1** Select [Bracketing] in Step 3 on p.74, and press **Fn**.

The detailed setting screen appears.

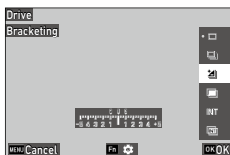

- 2** Use **▲▼◀▶** to change the setting.

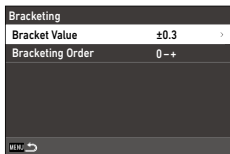

Bracket Value	Sets the range in which to change the exposure from $\pm 0.3$ to $\pm 5.0$ .
Bracketing Order	Sets the order of 3 images to be taken from [0 - +], [- 0 +], [+ 0 -], and [0 + -].

- 3** Press **MENU**.

The [Drive] screen reappears.

- 4** Press **OK**.

The shooting screen reappears.

- 5** Press **SHUTTER**.

Three images are saved in the set order with one release of the shutter.



**Memo** -----

- When using the flash, pictures are taken while automatically changing flash exposure.

## Shooting While Merging Images Together (Multi-exposure)

- 1 Select [Multi-exposure] in Step 3 on p.74, and press **Fn**.

The detailed setting screen appears.



- 2 Use **▲▼◀▶** to change the setting.

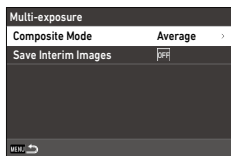

Composite Mode	[Average]: Creates a composite image with the average exposure. [Additive]: Creates a composite image with the cumulatively added exposure. [Bright]: Creates a composite image replacing only the portions that are brighter compared with the first image.
Save Interim Images	Specifies whether to save unprocessed images and images in the middle of processing. Images in the middle of processing are saved in JPEG format.

- 3 Press **MENU**.  
The [Drive] screen reappears.
- 4 Press **OK**.  
The shooting screen reappears.
- 5 Take the first image.

## 6 To take the next image, select [Next shot], and then press **OK**.

To retake the image, select [Retake shot].

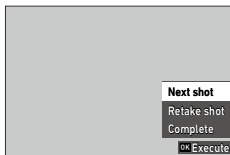

## 7 Take the next image.

Repeat Steps 6 and 7.

To return to the previous merged image, select [Retake shot].

## 8 Select [Complete] to end shooting.

The merged image is saved.



### Caution

---

- The settings for the following functions cannot be changed during the multiple exposure shooting.
  - [White Balance] of the 3 menu
  - [Drive Mode] of the 4 menu
  - [File Format], [Aspect Ratio], [Crop], and [JPEG Recorded Pixels] of the 5 menu
  - [Image Control] of the 6 menu



## Shooting Automatically at Set Intervals (Interval Shooting)

The camera takes pictures automatically at fixed intervals.

- 1** Select [Interval Shooting] in Step 3 on p.74, and press **Fn**.

The detailed setting screen appears.

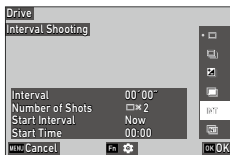

- 2** Use **▲▼◀▶** to change the setting.

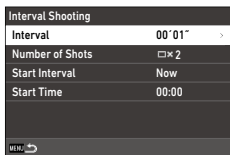

Interval	Specifies the shooting interval to the minimum time or in the range up to 60 minutes.
Number of Shots	Specifies the number of shots to [∞] or from [2] to [99].
Start Interval	Specifies whether to take the first image immediately or at the set time.
Start Time	Specifies the time when [Start Interval] is set to [Set Time].

- 3** Press **MENU**.

The [Drive] screen reappears.

- 4** Press **OK**.

The shooting screen reappears.

- 5** Press **SHUTTER**.

When [Start Interval] is set to [Now], the first image is taken. When [Set Time] is set, shooting starts at the set time.

To cancel shooting, press **OK**.

**Caution** -----

- Depending on the shooting settings, the time until the next picture is taken may be longer than the time set for interval shooting.
- When the shooting interval is short, the exposure for the first image may be used for the second and later images.
- The interval shooting is canceled if the exposure mode is changed or the power is turned off.

**Memo** -----

- For each interval shooting, a new folder is created and the captured images are saved there.
- If shooting is performed with “Full Press Snap” when [Focus] (p.57) is set to [MF], [Snap], or [ $\infty$ ] in the  1 menu, the focus is fixed at the position of the first shot.
- The use of the battery with sufficient power or the optional AC adapter (D-AC166) is recommended.

## Recording Star Trails (Interval Composite)

- 1 Mount the camera on a tripod, and take a test shot.**  
Set the exposure, focus mode, and white balance, and then check the composition. Images are merged with this exposure setting.

- 2 Select [Interval Composite] in Step 3 on p.74, and press **Fn**.**

The detailed setting screen appears.

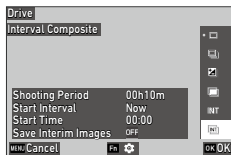

- 3 Use **▲▼◀▶** to change the setting.**

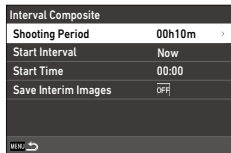

Shooting Period	Specifies the shooting period to [∞] or in the range from 10 minutes to 24 hours.
Start Interval	Specifies whether to take the first image immediately or at the set time.
Start Time	Specifies the time when [Start Interval] is set to [Set Time].
Save Interim Images	Specifies whether to save unprocessed images and images in the middle of processing. Images in the middle of processing are saved in JPEG format.

- 4 Press **MENU**.**  
The [Drive] screen reappears.

- 5 Press **OK**.**  
The shooting screen reappears.

## 6 Take the first image.

Images are taken continuously at the shortest interval.

To check the images being merged, press **SHUTTER** halfway.

If **SHUTTER** is pressed fully, the images merged up to that point are saved as they are, and the interval composite shooting starts with a new image.

To cancel shooting, press **OK**.



### Caution

---

- If **OK** is pressed or **SHUTTER** is fully pressed during exposure, the image at that moment is not merged.
- The interval shooting is canceled if the exposure mode is changed or the power is turned off.
- Autofocus is not performed for the second image and subsequent images.
- [Slow Shutter Speed NR] of [Noise Reduction] in the 6 menu and [Shake Reduction] of the 7 menu are fixed to [Off].



### Memo

---

- When [Save Interim Images] is set to save unprocessed images and images in the middle of processing, a new folder is created and the images are saved there for each interval composite.
- The values of the following settings are fixed when the first image is taken.
  - ISO sensitivity, shutter speed, and aperture value when ISO AUTO is set
  - White balance value when the white balance is set to [Auto White Balance]
- During shooting in a dark location, using the optional external viewfinder (GV-3) is convenient.

## Using the Self-timer

In the drive modes other than [Continuous Shooting], [Self-timer] can be used.

The self-timer can be set to [10sec.] or [2sec.].

The AF assist light blinks during the countdown for self-timer shooting.

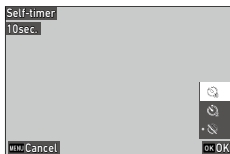

### Memo

- The self-timer can only be used for the first image in [Interval Shooting] and [Interval Composite]. When [Start Interval] is set to [Set Time], the self-timer cannot be used.
- You can set the AF assist light not to blink during the countdown. (p.129)

# Configuring the Capture Settings

## Image Capture Settings

Set the file format for still images in [Image Capture Settings] of the 5 menu.

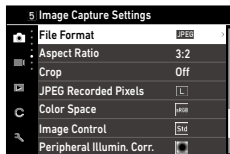

File Format	[JPEG] [RAW]: Records a RAW image (DNG format). [RAW+JPEG]: Records a RAW image simultaneously with a JPEG image.
Aspect Ratio	[3:2], [1:1]
Crop	[50mm], [71mm], [Off]
JPEG Recorded Pixels	[L], [M], [S], [XS]
Color Space	[sRGB], [AdobeRGB]





### Memo

- When [Aspect Ratio] is set to [1:1], black band(s) appears at the right and left sides of the monitor.
- This function can be registered to [ADJ Mode Setting] or [Fn Button Setting] in the 2 menu. (p.121, p.123)  
If [JPEG → RAW] or [JPEG → RAW+] is set to [Fn Button Setting], the image format can be easily switched.



### Shooting RAW Images

- A RAW image can be converted to JPEG format in [RAW Development] of the 2 menu. (p.100)
  - The following functions are not reflected in RAW images. These functions can be reflected when a RAW image is converted to JPEG format in [RAW Development] of the 2 menu.
    - Image Control
    - Shadow Correction
- When [RAW+JPEG] is set, the functions mentioned above are reflected in JPEG images only.



## Crop

- When [Crop] is set to [50mm] or [71mm], the 35 mm equivalent angle of view is changed from default 40 mm to 50 mm or 71 mm, and the image display is also changed.
- When [Crop] is set, a restriction is applied to [JPEG Recorded Pixels].

Crop	JPEG Recorded Pixels
50mm	When [L] is set: Records images with [M].
71mm	When [L] or [M] is set: Records images with [S].

## Movie Capture Settings

Set the file format for movies in [Movie Capture Settings] of the **15** menu.

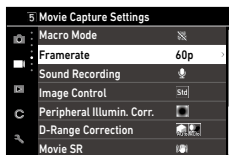

Framerate	[60p], [30p], [24p]
Sound Recording	[On], [Off]

# Setting the Image Finishing Tone and Correction

## Using the ND Filter

With [ND Filter] in the 2/ 2 menu, you can set whether or not to always use the camera's internal ND filter.

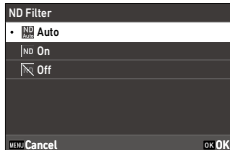

Auto	The camera determines whether to turn the function on or off according to conditions. The ND filter is used if the icon is displayed on the shooting screen when <b>SHUTTER</b> is pressed halfway. [Auto] cannot be selected in  4 mode.
On	The ND filter is always used. The icon is displayed on the shooting screen.
Off	The ND filter is not used.



### Memo

- This function can be registered to [Fn Button Setting] in the 2 menu. (p.123)

## Reducing Moiré (AA Filter Simulator)

A moiré reduction effect simulating that of a low-pass filter can be achieved with [AA Filter Simulator] of the 4 menu. [High], [Low], or [Off] can be selected.

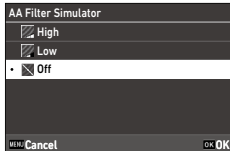















### Caution

- When shooting with a fast shutter speed or using a flash, the full effect of this function may not be achieved.



## Setting the Image Atmosphere (Image Control)

Images with varied saturation and contrast can be taken.  
The settings such as the hue can be changed to take distinctive images.

 Standard	Takes images with normal image quality.
 Vivid	Takes images with sharp and vivid colors.
 Monotone	Takes a black and white image.
 Soft Monotone	Takes a black and white image that gives soft impression. This cannot be selected in  mode.
 Hard Monotone	Takes a black and white image that gives hard impression.
 Hi-Contrast B&W	Takes a black and white image with stronger contrast. Makes it possible to take images with a grainy feel, such as that created with ultra-high-sensitivity film in a film camera or with push processing film at the development stage.
 Positive Film	Takes highly saturated images like those taken with positive film.
 Bleach Bypass	Takes images with low saturation and high contrast.
 Retro	Takes images that look like old photos.
 HDR Tone	Takes images finished like a painting with enhanced fine contrast. This cannot be selected in  mode.
 Cross Processing	Takes images with changed color and contrast as if they were cross-processed.
 Custom 1  Custom 2	Two settings can be registered.



## Correcting the Peripheral Illumination

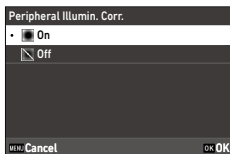

With [Peripheral Illumin. Corr.] of the 6/ 6 menu, you can reduce peripheral light fall-off occurring due to lens properties.

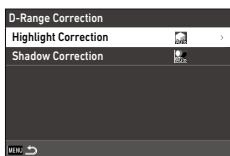

## Correcting a Range of Tones (D-Range Correction)

With [D-Range Correction] of the 6/ 6 menu, you can expand an image gradation to make the bright and dark portions of an image clearly visible.



 Highlight Correction	[Auto], [On], or [Off] can be selected. [On] cannot be selected in  mode.
 Shadow Correction	[Auto], [Low], [Medium], [High], or [Off] can be selected.





### Caution

- When [Shadow Correction] is set to [High], noise may be noticeable in images.
- When the ISO sensitivity is set to a value lower than ISO 200, [Highlight Correction] has no effect.



## Reducing Blurring of Images

To automatically reduce blurring of images, set the following functions. By default, both settings are set to [On].

Still image mode	[Shake Reduction] of the  7 menu
Movie mode	[Movie SR] of the  7 menu



### Memo

- If [Shake Reduction] is set to [Fn Button Setting] in the  2 menu, the Shake Reduction function can be turned on and off with button operation only. (p.123)
- When [Self-timer] is set in [Drive Mode], [Shake Reduction] is automatically set to [Off]. To fix the setting to [On], set [Auto SR Off] to [Disable Auto SR Off] in the 7 menu.

## Correcting the Horizontal Camera Angle

With [Horizon Correction] of the 7 menu, you can correct the horizontal camera angle detected by the electronic level for taken images.

## Using the Playback Functions

You can set the playback functions from the **▶** menu or on the playback functions setting screen.

Press **⏏** in the playback mode to display the playback functions setting screen. The **▶ 1/▶ 2** menu settings can be set on the playback functions setting screen.



### Caution

- The playback functions that are not supported by the displayed image cannot be used.

## Changing the Playback Method



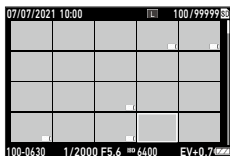

### Displaying Multiple Images

You can display multiple images in the thumbnail view.

- 1 Turn  to the left once in the single image display of playback mode.  
Multiple images are displayed.



The following operations are available.



	Moves the selection frame.
	Switches between 20-image view and 48-image view.
	Deletes the selected image.
	Displays the playback functions setting screen.

- 2 Press **OK**.

The selected image is displayed in the single image display.



#### Memo

- Images are played back in order of shooting date. The playback order can be changed to [File No.] in [Playback Order Options] of the  3 menu.
- If you select [Delete], [Protect], or [File Transfer] of the  1 menu while multiple images are displayed, each function is applied to all the displayed images.

## Selecting and Deleting Multiple Images

**1** Press **[Fn]** on the screen in Step 1 of “Displaying Multiple Images” (p.92).

**2** Select images in multi-image display.

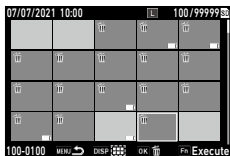

<b>▲▼◀▶</b>	Moves the selection frame.
<b>OK</b>	Selects/Deselects an image.
<b>DISP</b>	Selects the starting or ending point for image selection range.

**3** Press **[Fn]**.  
The deletion confirmation screen appears.

**4** Select **[Execute]**, and press **OK**.  
The selected images are deleted.



### Memo

- Protected images cannot be selected.
- The method to select multiple images is the same also for the following functions.
  - Protect (p.97)
  - File Transfer (p.99)

Display the **[▶]** menus or playback functions setting screen in Step 1 of “Displaying Multiple Images” (p.92), and select the function.

## Displaying Rotated Images

You can change image rotation information.

- 1 Select [Image Rotation] in the **▶ 1** menu or on the playback functions setting screen, and press **▶**.
- 2 Select the rotation direction, and press **OK**.

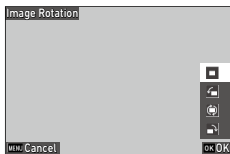

4



### Memo

- In the playback mode, the displayed image is rotated according to the camera's orientation. When [Auto Image Rotation] is set to [Off] in the **▶ 3** menu, the image display orientation is fixed regardless of the [Image Rotation] setting.



### Caution

- Rotation direction cannot be changed when the write-protect switch on the memory card is locked or for the following images.
  - Movies
  - Protected images



## Connecting the Camera to an AV Device

Connect the camera to an AV device such as TVs to display Live View images while shooting or to play back images.

Prepare a commercially available conversion cable that is suitable for the device connected to the camera.

**1** Turn the AV device and camera off.

**2** Open the terminal cover of the camera, and connect the conversion cable to the USB terminal.

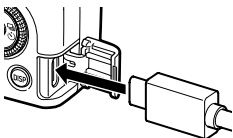

**3** Connect the other end of the conversion cable to the input terminal on the AV device.

For details, refer to the operating manual for the AV device.

**4** Turn the AV device and camera on.

**Caution** -----

- While the camera is connected to an AV device, nothing is displayed on the camera monitor.
- The audio of the video is output from the AV device. Adjust the volume on the AV device.

**Memo** -----

- The USB terminal (USB Type-C) on this camera supports DisplayPort.
- To output images to a device with an HDMI® terminal, used a USB (Type-C)-to-HDMI® adapter. Some adapters cannot be used with this camera.

# Organizing Files

## Deleting Files

**1** Select [Delete] in the **▶ 1** menu or on the playback functions setting screen.

**2** Select [Delete 1 image] or [Delete All Images].

When [Delete 1 image] is selected, use ◀▶ to select an image.

For images taken with [File Format] set to [RAW+JPEG], you can select file formats to delete.

When [Delete All Images] is selected, you cannot select file formats to delete.

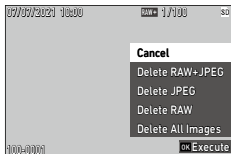

**3** Press **OK**.

The image is deleted.

Repeat Steps 2 and 3 to delete another image.

To end the process, select [Cancel].

## Protecting Images from Deletion

You can protect images to prevent them from being deleted accidentally.

**1** Select [Protect] in the **1** menu or on the playback functions setting screen.

**2** Select [Protect 1 Image] or [Protect All Images].

When [Protect 1 Image] is selected, use **◀▶** to select an image.

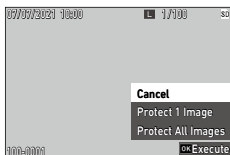

**3** Press **OK**.

When [Protect 1 Image] is selected, the selected image is protected.

To protect another image, repeat Steps 2 and 3.

When [Protect All Images] is selected, select [Protect] or [Unprotect]. All images are protected or unprotected.



### Memo

- To unprotect the image, set [Protect] again.





### Caution

- If [Format] of the **1** menu is performed, protected images are also deleted.

## Copying Images and Movies in the Internal Memory to a Memory Card

You can copy the still images and movies stored in the internal memory to a memory card.

**1** Insert a memory card.

**2** Select [Image Copy] in the  1 menu or on the playback functions setting screen, and press .

**3** Select [Execute], and press **OK**.

The still images and movies stored in the internal memory are copied in a new folder.



### Caution

---

- If there is not enough space available on the copy destination memory card, a message indicating that there is insufficient space appears.
- Copying from a memory card to the internal memory is not possible.

## Transferring Images

Select images to transfer to a communication device and set the transfer reservation. When the camera is connected to a communication device via wireless LAN, the file transfer automatically starts.

**1** Select [File Transfer] in the **▶ 1** menu or on the playback functions setting screen.

**2** Select [Transfer 1 image].

Use ◀▶ to select an image.

For images taken with [File Format] set to [RAW+JPEG], you can select file formats to transfer.

**3** Press **OK**.

The transfer reservation is set for the image.

To transfer another image, repeat Steps 2 and 3.

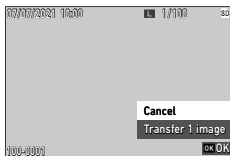

### Memo

- To cancel the transfer reservation, set [File Transfer] again.
- Refer to "Using the Camera with a Communication Device" (p.111) for how to connect the camera and a communication device.

## Editing and Processing Images

You can edit and process taken images and then save them as new images.



### Caution

- Only JPEG images taken with this camera can be edited and processed (only RAW images in [RAW Development]). Still images saved from movies cannot be edited and processed. If you edit and process images repeatedly, image quality will deteriorate.

## Developing RAW Images

You can convert RAW images into JPEG format and then save them as new files. Various settings such as [White Balance] and [Image Control] can be configured and saved.

1

Display a RAW image in **▶** mode.

2

Select [RAW Development] in the **▶** 2 menu or on the playback functions setting screen, and press **OK**.

The [RAW Development] screen appears.

3

Use **▲▼** to select a parameter.

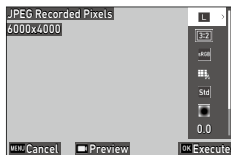

The following settings are available.

- JPEG Recorded Pixels
- Aspect Ratio
- Color Space
- White Balance
- Image Control
- Peripheral Illumin. Corr.
- Sensitivity
- High-ISO Noise Reduction
- Shadow Correction

The settings that were set at the time of shooting are initially selected.

You can select only the changeable settings.

	Displays the Preview.
	During the Preview: Magnifies the image.

## 4 Press **▶**.

The detailed setting screen appears.

## 5 Use **▲▼** to select a setting.

The detailed setting screen appears when **[Fn]** is pressed for [White Balance] or [Image Control].

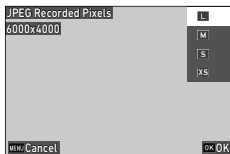

## 6 Press **OK**.

The parameter setting screen reappears.

## 7 When you have finished configuring all of the settings, press **OK**.

A new JPEG image is saved.

## 8 Select [Continue] or [Finish], and press **OK**.

When [Continue] is selected, the screen in Step 3 reappears.



### Caution

- When the [Aspect Ratio] setting has been changed in the **5** menu during shooting, the aspect ratio cannot be specified with [RAW Development].

## Changing the Image Size

### Changing the Number of Recorded Pixels (Resize)

In [Resize] of the **▶ 2** menu, JPEG files can be reduced in size. The smaller size than the [JPEG Recorded Pixels] setting for shooting can be selected.

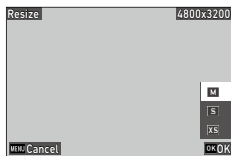

4





Playback Functions

### Cropping Images

You can crop a part of JPEG images and then save the images.

- 1 Select [Cropping] in the **▶ 2** menu or on the playback functions setting screen, and press **▶**.
- 2 Specify the range to crop.



<b>▲▼◀▶</b>	Moves the cropping frame.
Press <b>ADJ</b>	Changes the aspect ratio of the cropping frame (16:9, 3:2, 4:3, or 1:1).
<b>DISP</b>	Switches the  operation between changing the cropping size and rotating the image.
	Changes the cropping size or rotates the cropping frame 0.1°.
<b>Fn</b>	Rotates the cropping frame 90°.
	Displays the Preview.
	During the Preview: Magnifies the image.

- 3 Press **OK**.

The cropped image is saved as a new image.



## Correcting Highlight/Shadow Areas (Levels Adjustment)

You can correct the brightness and contrast of the highlight, mid-tone, and shadow areas in JPEG images.

- 1 Select [Levels Adjustment] in the **▶ 2** menu or on the playback functions setting screen, and press **▶**.

The [Levels Adjustment] screen appears.

- 2 Adjust the value.

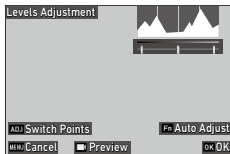

Press <b>ADJ</b>	Switches the adjustment points.
<b>◀▶</b> / <b>ADJ</b> to the left or right	Adjusts the value.
<b>Fn</b>	Performs the auto correction.
<b>⏏</b>	Displays the Preview.
<b>⤴</b>	During the Preview: Magnifies the image.

- 3 Press **OK**.

The image is saved as a new image.



### How to Perform Corrections

- Slide the center thumb to the right or left to adjust the overall image brightness. Sliding the thumb to the left makes the image brighter. Sliding the thumb to the right makes the image darker.

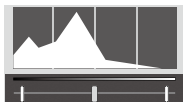

- For overexposed images, slide the left thumb to the right until it reaches the left end of the histogram. For underexposed images, slide the right thumb to the left until it reaches the right end of the histogram.

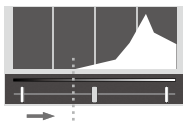

- When the spikes of the histogram are concentrated in the center and the image contrast is low, slide the right and left thumbs to both ends of the histogram.

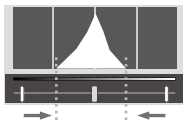

## Correcting the White Balance

You can correct the white balance of JPEG images.

- 1** Select [WB Adjustment] in the **▶2** menu or on the playback functions setting screen, and press **▶**.  
The [WB Adjustment] screen appears.

- 2** Adjust the value.

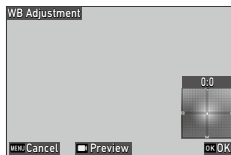

	Moves the adjustment points.
	Displays the Preview.
	During the Preview: Magnifies the image.

- 3** Press **OK**.  
The image is saved as a new image.

## Correcting Color Moiré

You can correct color moiré in images.

- 1** Select [Color Moiré Correction] in the **▶ 2** menu or on the playback functions setting screen, and press **▶**.  
The [Color Moiré Correction] screen appears.

- 2** Adjust the value.

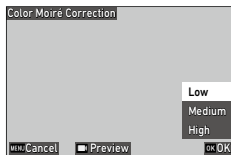

▲▼	Selects the correction level.
🖼️	Displays the Preview.
🔍	During the Preview: Magnifies the image.

- 3** Press **OK**.

The image is saved as a new image.



### Caution

- Some images may not be corrected properly.
- If you perform [Color Moiré Correction], color loss or color bleeding may occur.

## Adjusting the Image Quality

You can adjust the quality level of JPEG images.

- 1 Select [Base Parameter Adj] in the **▶ 2** menu or on the playback functions setting screen, and press **▶**.

The [Base Parameter Adj] screen appears.

- 2 Use **Fn** to switch between normal editing and monotone editing.

- 3 Adjust the value.

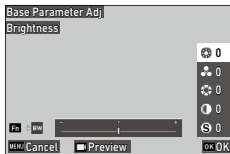

▲ ▼	Normal editing: Selects [Brightness], [Saturation], [Hue], [Contrast], or [Sharpness]. Monotone editing: Selects [Brightness], [Filter Effect], [Toning], [Contrast], or [Sharpness].
◀ ▶	Selects a value ( $\pm 4$ ).
🖼️	Displays the Preview.
🔍	During the Preview: Magnifies the image.

- 4 Press **OK**.

The image is saved as a new image.

## Editing Movies

You can clip or divide a movie file into multiple segments and save as new files.

- 1** Select [Movie Edit] in the **▶ 2** menu or on the playback functions setting screen, and press **▶**.

The [Movie Edit] screen appears.

- 2** Select [Cut] or [Divide], and press **OK**.





Cut	Saves a range specified with the starting and ending points as a new movie file.
Divide	Divides a movie into two files at the specified division point and saves as new files.

- 3** Specify the starting and ending points or division point.

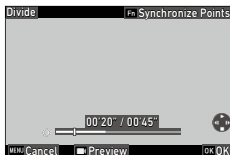
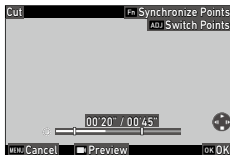
You can play or pause the movie in the same manner as when viewing a movie in the playback mode.



The following operations are also available.

Press <b>ADJ</b>	[Cut]: Switches between the starting and ending points.
	[Cut]: Moves the starting or ending point. [Divide]: Moves the division point.
<b>Fn</b>	[Cut]: Moves the starting or ending point to the playback point. [Divide]: Moves the division point to the playback point.
	Displays the Preview.

## 4 Press **OK**.

The movie file is saved as a new file.

## Using the Camera with a Computer

Connect the camera to a computer using the provided USB cable.

**1** Turn the camera off.

**2** Open the terminal cover of the camera, and connect the USB cable to the USB terminal.

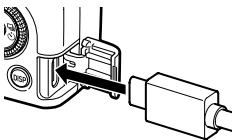

**3** Connect the USB cable to the USB port of the computer.

The camera turns on and enters the playback mode.

The camera is recognized as a device by the computer.

When a memory card is inserted, the files on the memory card are displayed.

When a memory card is not inserted, the files in the internal memory are displayed.

**4** Copy the captured images to the computer.

**5** Disconnect the camera from the computer when the copy is complete.

**6** Remove the USB cable from the camera.

**Caution** -----

- Do not remove the USB cable while copying images.
- If the battery level is low, it may take some time until the camera is recognized by the computer.

**Memo** -----

- When the camera is connected to a computer, it is recognized as a device with the name "RICOH GR IIIx".
- The battery is charged when the camera is connected to the computer and the camera is turned off.
- Refer to "Operating Environment" (p.153) for system requirements to connect the camera to a computer.



## Using the Camera with a Communication Device

The camera can be operated from a communication device and the images saved in the camera can be displayed on/imported to the communication device by connecting both the devices via Bluetooth® or wireless LAN and using the dedicated app “Image Sync”.



### Memo

- The captured images can be transferred to the communication device by specifying them in [File Transfer] of the 1 menu. (p.99) The images can also be transferred automatically after shooting. (p.116) When the captured images are transferred, the camera is connected to the communication device via a wireless LAN.
- The Bluetooth® connection and the wireless LAN connection can be switched using the Image Sync.
- When using the camera with a communication device, refer to the operating manual of the device and the Image Sync website. (p.116).
- The Image Sync screen differs depending on the camera used, communication device OS, and app version. The specifications of the app are subject to change without notice to improve functions.



### Caution

- The wireless LAN function is disabled in the following cases.
  - mode
  - During the USB connection

## Connecting to a Communication Device via Bluetooth®

5

Sharing Images

- 1 Install the Image Sync on the communication device.
- 2 Turn on the Bluetooth® function of the communication device.
- 3 Select [Bluetooth Setting] in the 6 menu, and press . The [Bluetooth Setting] screen appears.

- 4 Select [Action Mode], and press .

- 5 Select [On anytime] or [On when power is on], and press .

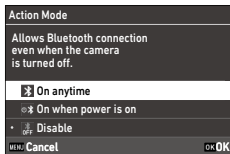

- 6 Select [Pairing], and press .

- 7 Select [Execute Pairing], and press .

The camera enters a pairing standby state, and the camera's [Device Name] and [Password] are displayed.

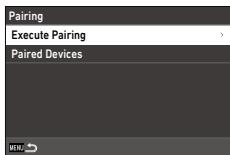

- 8 Start the Image Sync on the communication device, select [GR IIIx] on the model selection screen, and then tap [Connect over Bluetooth].

The camera and the communication device are paired.

When the camera is connected to the communication device via Bluetooth®, the icon indicating the connected status appears.





### Caution

---

- When the OS of the communication device is iOS, connect it to the camera using the Image Sync. For details on the Image Sync, refer to "Operating the Camera with a Communication Device" (p.116).
- Note that when [On when power is on] is selected in Step 5, the camera emits radio waves even if its power is off.
- Do not attempt to use the Bluetooth® function in a location where the use of Bluetooth® devices is restricted or prohibited, such as on airplanes.
- When using the Bluetooth® function, observe local laws and regulations governing radio communication.





### Memo

---

- Select [Paired Devices] on the screen in Step 7 to display the names of paired communication devices. You can cancel the pairing by pressing **[Fn]** on this screen. The pairing can be established with up to six communication devices.
- Select [Communication Info.] in Step 4 to display the camera's [Device Name].
- When [On anytime] is set in Step 5, you can turn on the camera and establish the Bluetooth® connection by operating the Image Sync even if the power of the camera is off.

## Enabling the Wireless LAN Function

The wireless LAN function is off when the camera is turned on. Turn on the function using one of the following methods.

- Setting from the menus (p.114)
- Pressing and holding  (p.115)
- Pressing and holding  (p.115)



### Memo



- When the wireless LAN function is turned on, the icon indicating the wireless LAN status appears on the screen.
- Even after the wireless LAN function is turned on, it turns off when the camera is turned off and on again.



### Caution

- Do not attempt to use the wireless LAN function in a location where the use of wireless LAN devices is restricted or prohibited, such as on airplanes.
- When using the wireless LAN function, observe local laws and regulations governing radio communication.

## Setting from the Menus

- 1 Select [Wireless LAN Setting] in the  6 menu, and press .
- 2 Select [Action Mode], and press .
- 3 Select [On], and press **OK**.

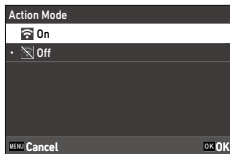

### Memo

- Select [Communication Info.] in Step 2 to display the camera's [SSID], [Password], and [MAC Address]. To reset the SSID and password to the default settings, press **Fn**.
- The certification marks of the wireless LAN can be displayed in [Certification Marks] of the  8 menu. (p.2)

## Pressing and Holding the Movie/Wireless Button

### 1 Press and hold .

A beep sounds and the wireless LAN icon appears on the shooting screen.

Press and hold  again to turn off the wireless LAN function.

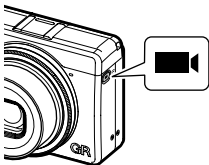

## Pressing and Holding the Playback Button



The wireless LAN function can be turned on in the playback mode from the power-off state of the camera.

### 1 Press and hold with the camera turned off until a beep sounds.

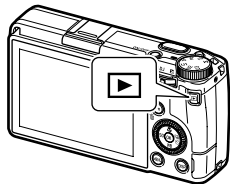
The camera is turned on in the playback mode and the wireless LAN function is turned on.



### Caution

- When the wireless LAN function is turned on using , the camera does not enter the shooting mode even if the shutter release button is pressed. When performing shooting or other operations, press  to turn the camera off and press the power button to turn the camera back on.

## Operating the Camera with a Communication Device

The following functions can be used by connecting the camera to a communication device via Bluetooth® or wireless LAN and using the dedicated app “Image Sync”.

Remote Capture	Displays the shooting screen of the camera on the communication device, and enables controlling exposure settings and shooting by operating the communication device.
Image View	Displays the images saved in the camera on the communication device and imports them to the communication device.
Time Synchronization	Synchronizes the date and time displayed on the camera with the date and time settings of the communication device.

Image Sync supports iOS and Android™, and can be downloaded from the App Store or Google Play™. For the supported operating system and other details, refer to the download site.



### Memo

- For how to connect the camera to a communication device and details on the Image Sync, refer to the following website.

<https://www.ricoh-imaging.co.jp/english/products/app/image-sync2/>

- You can use the Image Sync installed on the communication device to operate the camera and adjust the camera's date and time.
- You can make the following settings in [Smartphone Link] of the  6 menu.



Store Location Info.	Records the location information of the communication device in captured images.
Auto Image Transfer	Automatically transfers captured images to the communication device after shooting. The format of transferred files can be selected.
Auto Resize	When set to [On], automatically sets [JPEG Recorded Pixels] to [XS] for transferred images.
Image Transfer while Off	Sets whether to continue to transfer images when the camera is turned off during transfer processing.

- When the camera is connected with a communication device via Bluetooth®, the wireless LAN function automatically turns on and off according to the situation.

## Saving Frequently Used Settings

You can save up to six frequently used settings and assign the settings to the mode dial **U1**, **U2**, and **U3** so that you can easily recall the settings for shooting.

The following settings can be saved.

- Exposure mode
- Exposure compensation
-  menu settings (with exceptions)
- **C** 2 menu settings and the [Grid Style] setting of the **C** 3 menu

## Saving the Settings

Up to six sets of settings can be saved.

**1** Set the exposure mode and all the necessary settings to save.

**2** Select [Save Settings] in the **C** 1 menu, and press **▶**.

The [Save Settings] screen appears.

**3** Select from [BOX1] to [BOX6], and press **OK**.

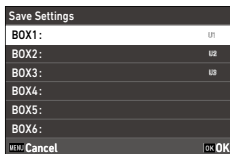
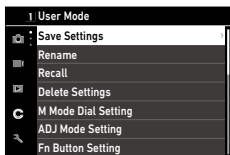

**4** Select whether to enter a Box name, and press **OK**.

When [Cancel] is selected, proceed to Step 7.

When [Enter Name] is selected, the text-entry screen appears.

**5** Enter a Box name.

Up to 32 single-byte alphanumeric characters and symbols can be entered.



The following operations are available.

	Moves the text selection cursor.
	Moves the text selection cursor up and down.
<b>ADJ</b>	Moves the text selection cursor to the right and left.
<b>OK</b>	Enters a character selected with the text selection cursor.

You can use the touch panel for the operations.

**6** After entering the text, move the text selection cursor to and press **OK**.

The confirmation screen appears.

**7** After checking the setting, press **OK**.

The **C 1** menu reappears.

**Memo** -----

- If a name is not entered, the registration date and time will be the name.
- To change the name, select [Rename] in the **C 1** menu.
- To delete the setting, select [Delete Settings] in the **C 1** menu.



## Assigning Settings to the Mode Dial

You can assign the saved settings to the mode dial.

- 1** Select [Recall] in the **C** 1 menu, and press **▶**.  
The [Recall] screen appears.

- 2** Select the mode dial to assign the saved setting to from **USER1 (U1)**, **USER2 (U2)**, or **USER3 (U3)**, and press **▶**.

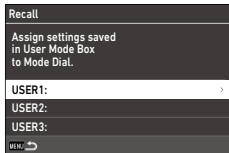

- 3** Select from **[BOX1]** to **[BOX6]**, and press **OK**.  
The selected setting is assigned to the mode dial.  
The screen in Step 2 reappears.

## Using the Saved User Mode

### 1 Set the mode dial to **U1**, **U2**, or **U3** in the shooting mode.

The user mode guide appears on the shooting screen.

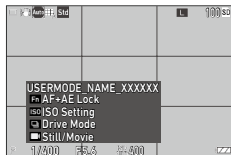

### 2 Change the setting as necessary.

To change the exposure mode, set [Exposure Mode] in the 2 menu.

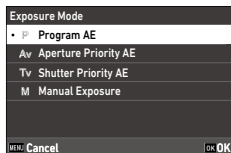

6

Changing the Settings



#### Memo

- The setting changed in Step 2 is not saved in the camera. If the mode dial is turned, the setting is reset to the saved setting. To change the saved setting, save a setting in [Save Settings] again.
- If the Box settings assigned to the mode dial are changed, the settings applied to the mode dial are also changed.

# Customizing the Button Functions

## Registering Functions to the ADJ. Mode

You can change the settings for “ADJ. mode” of which functions can be easily used by pressing **ADJ**.

Five functions in the following shooting functions can be registered. (The functions indicated with a square-bracketed item are the default settings for the item.)

- Off
- Focus [Setting2]
- Snap Focus Distance
- File Format [Setting4]
- Aspect Ratio
- Crop
- JPEG Recorded Pixels
- AE Metering [Setting3]
- ISO Setting
- Flash Mode
- Flash Exposure Comp.
- Drive
- Self-timer
- Image Control [Setting1]
- One Push AE in M Mode
- Touch AF
- Outdoor View Setting [Setting5]

**1** Select [ADJ Mode Setting] in the **C 2** menu, and press **▶**.  
The [ADJ Mode Setting] screen appears.

**2** Select from [Setting1] to [Setting5], and press **▶**.

**3** Select the function to register, and press **OK**.  
The function for the ADJ. mode is changed.

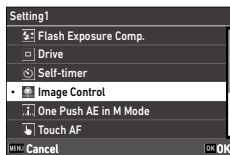
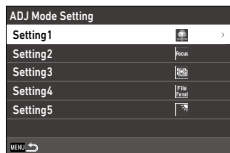

**Caution** -----

- The settings changed in [ADJ Mode Setting] are enabled in the still image mode only. [Image Control], [Focus], [AE Metering], [Framerate], and [Outdoor View Setting] are registered for the  mode, and they cannot be changed.

**Memo** -----

- Refer to "Using the ADJ. Lever" (p.23) for how to use the ADJ. mode.

## Changing the Functions of the Fn Button

You can change the functions for when **Fn**, **◀**, **▶**, or **🎬** is pressed. The following functions can be assigned to each button. (The functions indicated with a square-bracketed item are the default settings for the item.)

### Pressing **Fn**, **◀**, **▶**, or **🎬**

- Off
- Focus
- Set MF
- Set Snap
- Set Tracking AF
- Enable AF
- AF+AE Lock [Fn Button]
- AE Lock
- Face/Eye Detection
- Snap Focus Distance
- File Format
- JPEG → RAW
- JPEG → RAW+
- Aspect Ratio
- Crop
- JPEG Recorded Pixels
- Framerate
- Still/Movie [Movie/Wireless Button]
- AE Metering
- ISO Setting [ISO Button]
- Flash Mode
- Flash Exposure Comp.
- ND Filter
- Drive Mode [Drive Button]
- Drive
- Continuous Shooting
- Self-timer
- Image Control
- Shake Reduction
- One Push AE in M Mode
- 4-way Controller Action
- Touch AF
- Outdoor View Setting

### Pressing and holding **🎬**

- Wireless LAN Setting [Hold Movie/Wireless Btn.]
- Preview

- 1** Select [Fn Button Setting] in the **C 2** menu, and press **▶**.  
The [Fn Button Setting] screen appears.

- 2** Select the button to change the setting of, and press **▶**.

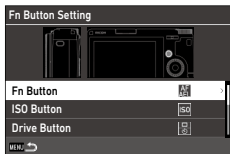

- 3** Select the function to assign, and press **OK**.  
The button function is changed.

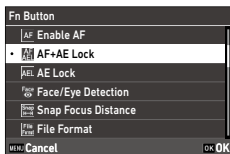

#### Memo

- On the [Fn Button Setting] screen, you can set the button functions for when the functions corresponding to the following operations are assigned.

Focus Settings	Select the button function from [Same as Shutter Button], [Auto-area AF], [Select AF], [Pinpoint AF], [Tracking AF], or [Continuous AF].
Keep AE Lock	When set to [On], AE lock is turned on and off each time the button is pressed. When set to [Off], AE lock is only enabled while the button is pressed.
One Push AE in M Mode	If the button is pressed in the <b>M</b> mode, the exposure is automatically adjusted to the correct exposure. Select the mode to adjust from [Program AE], [Aperture Priority AE], or [Shutter Priority AE].

- When the power is turned on or the mode dial is turned, the current function of the button is displayed. If [Guide Display] is set to [Off] in the **2** menu, the function is not displayed.



#### Caution

- The function of **Fn** is enabled in the shooting mode only. Only [Wireless LAN Setting] is available in the playback mode.
- [Enable AF], [AF+AE Lock], [AE Lock], and [One Push AE in M Mode] cannot be assigned to **Fn**.

## Setting the Function of the Shutter Release Button

You can set the function for when **SHUTTER** is pressed in the **C 2** menu.

Shutter Button Setting	Sets whether to perform autofocus and AE Lock, or only AE lock when <b>SHUTTER</b> is pressed halfway.
Shutter Btn. Confirmation	Sets whether to complete the setting by pressing <b>SHUTTER</b> halfway when setting functions on the Live View screen such as in the ADJ. mode. This setting is also applied to when autofocus is activated using <b>Fn</b> . [On]: Completes settings by pressing <b>SHUTTER</b> halfway. [Off]: Returns to the setting screen after <b>SHUTTER</b> is pressed halfway.

## Display and Sound Settings

### Setting the Information Displayed During Shooting/Playback

You can set the information displayed when the display is switched using **DISP** in the shooting mode or playback mode.

- 1 Select [Shooting Info. Display] or [Playback Info. Display] in the **C 3** menu, and press **▶**.

The [Shooting Info. Display] or [Playback Info. Display] screen appears.

For [Playback Info. Display], proceed to Step 3.

- 2 Use **◀▶** to select [LCD Display], and press **ADJ** to set each display mode on/off.

[Standard Info. Display], [Simplified Info. Display], [No Information Display], and [Display Off] can be set.

Display modes without a check mark are not displayed when **DISP** is pressed during shooting. Select at least one display mode.

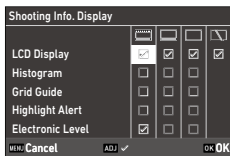

- 3 Use **▲▼◀▶** to select a display item, and press **ADJ** to set it on/off.

[Shooting Info. Display]

Histogram	Displays a histogram.
Grid Guide	Displays a guide grid.
Highlight Alert	Blinks areas expected to be overexposed in red during shooting.
Electronic Level	Displays an indicator for confirming camera tilt.



## [Playback Info. Display]

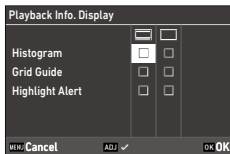



Histogram	Displays a histogram for the image.
Grid Guide	Displays grid lines.
Highlight Alert	Blinks overexposed areas in red.

**4** Press **OK**.

## Setting the Instant Review Display

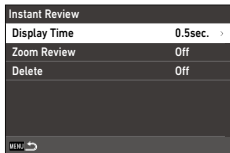
You can set the information displayed in “Instant Review” that displays the captured image immediately after shooting in [Instant Review] of the **C 3** menu.



Display Time	Sets the display time of Instant Review. When set to [Hold], the image is displayed until <b>SHUTTER</b> is pressed halfway.
Zoom Review	Magnifies the image by turning  or pressing <b>ADJ</b> during Instant Review.
Delete	Deletes the image by pressing  during Instant Review.

The initial magnification when magnifying images by pressing **ADJ** in Instant Review or the single image display of playback mode can be set in [Quick Zoom] in the **C 3** menu.

## Setting the Live View Display

You can set the following settings for the Live View display in the **C** 3 menu.

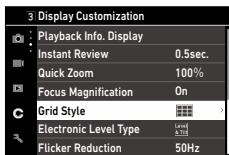

Grid Style	Select the grid style from [3x3 Grid] or [4x4 Grid].
Electronic Level Type	Select whether to display the horizontal level only, or horizontal level and tilt (vertical direction).
Flicker Reduction	Cuts down flickers on the Live View screen by setting the power frequency.

## 6

## Setting the Brightness and Tone of the Monitor

### LCD Setting

You can set [Brightness], [Saturation], [Adjust: Blue-Amber], and [Adjust: Green-Magenta] in [LCD Setting] of the **3** menu.

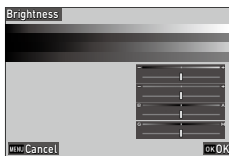

## Outdoor View Setting

If the monitor display is difficult to see when you take pictures outdoors or in other situations, adjust the brightness of the monitor in [Outdoor View Setting] of the **3** menu.

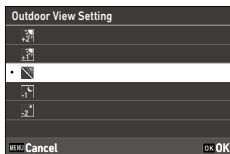

### Memo

- This function can be registered to [ADJ Mode Setting] of the **C 2** menu. (p.121)

## Setting the Lamp

You can set the lamp illumination setting in the **4** menu.

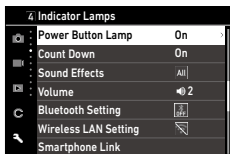

Power Button Lamp	Sets whether to turn the power button lamp on when the power is turned on.
Count Down	Sets whether to blink the AF assist light when shooting using [Self-timer] of [Drive Mode].

## Setting the Sound Effects

You can set the sound effects in the  5 menu.

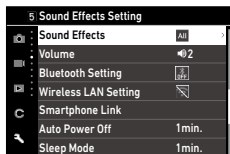

Sound Effects	[All]: Outputs shutter sound, in-focus sound, timer countdown sound, and switching sound of turning the wireless LAN on and off. [Shutter Sound Only]: Outputs shutter sound only.
Volume	Sets the sound volume. When set to [0], all sound effects are turned off.

## Power Saving Settings

### Automatically Turning the Power Off

The camera turns off automatically if no operations are made for a certain period of time. You can set [1min.], [3min.], [5min.], [10min.], [30min.], or [Off] in [Auto Power Off] in the  7 menu.

To resume operation, press the power button.

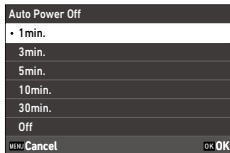

#### Memo

- [Auto Power Off] is not available in the following cases.
  - During movie recording or playback
  - During shooting with [Interval Shooting] or [Interval Composite] of [Drive Mode]
  - During data processing
  - During image transfer
  - While the camera is connected to a computer
  - While the camera is connected to a communication device with the Image Sync

## Dimming the Display

The camera dims the display automatically if no operations are performed during the set time. The following settings can be set in the  7 menu.

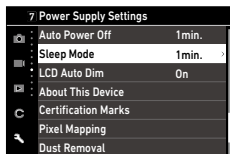

Sleep Mode	Turns off the monitor automatically if no operations are performed during the set time. The status lamp lights in the sleep mode. [1min.], [3min.], [5min.], [10min.], [30min.], or [Off] can be set.
LCD Auto Dim	Dims the display automatically if the camera is not moved within five seconds. [On] or [Off] can be set.

If the camera is operated, the original brightness is restored.

6



### Memo

- [Sleep Mode] is not available in the following cases.
  - During shooting with [Interval Shooting] or [Interval Composite] of [Drive Mode]
  - During movie recording or playback
  - While an AV device is connected to the camera
  - While the camera is connected to a communication device with the Image Sync
- [LCD Auto Dim] is not available in the following cases.
  - During Instant Review
  - In the playback mode
  - While an AV device is connected to the camera

## File Management Settings

### Specifying the Folder/File Settings

By default, files and folders are automatically named as follows.

File Name	R0000001.JPG to R0999999.JPG
Folder Name	100 to 999

When the file number exceeds R0\*\*9999, the next folder is created and the file number becomes R0\*\*0001. If the file number exceeds R0\*\*9999 when the folder number is 999, no more files can be stored on the memory card currently inserted.

The file and folder names can be changed.

#### Create New Folder

When [Create New Folder] is selected in the  1 menu, a folder is created with a new number when the next image is saved.



#### Caution

- You cannot successively create multiple folders.



#### Memo

- During shooting with [Interval Shooting] or [Interval Composite] of [Drive Mode], a new folder is automatically created.

## Folder Name

When images are captured with this camera, a folder is automatically created and the captured images are stored in it. Each folder name consists of a sequential number from 100 to 999 and a string of five characters. The character string in the folder name can be changed.

- 1** Select [Folder Name] in the **1** menu, and press **▶**.  
The [Folder Name] screen appears.

- 2** Select [Date] or [Optional] in [Folder Name].

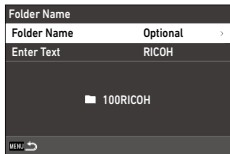

Date	Assigns four digits of the month and day of the shooting date after the folder number. The month and day appear according to the date format set in [Date Adjustment] of the <b>10</b> menu. Example) 101_0125: Images taken on January 25th
Optional	Assigns a freely defined string of five characters after the folder number. (Default: RICOH) Example) 101RICOH

Proceed to Step 6 if you select [Date] or do not need to change the character string.





- 3** Press **▶** to select [Enter Text], and press **▶**.  
The text-entry screen appears.

- 4** Enter a folder name.  
Up to five single-byte alphanumeric characters can be entered.





The following operations are available.

	Moves the text selection cursor.
	Moves the text selection cursor up and down.
	Moves the text selection cursor to the right and left.
	Enters a character selected with the text selection cursor.

You can use the touch panel for the operations.

## 5 After entering the text, move the text selection cursor to ←, and press **OK**.

The confirmation screen appears.

## 6 After checking the setting, press **OK**.

The [Folder Name] screen reappears.



### **Memo** -----

- If the folder name is changed, a folder with a new number is created the next time shooting is performed.



### **Caution** -----



- The maximum folder number is 999. If the folder name is changed or a new folder is created after the folder number reaches 999, you cannot capture new images. Also, you cannot capture new images when the file name number reaches 9999.

## File Name

For still images, one of the following string of characters is used as the file name prefix depending on the [Color Space] (p.84) setting of the 5 menu.

Color Space	File Name
sRGB	R0*****.JPG
AdobeRGB	_R*****.JPG

You can change the first two characters of file names from "R0".

**1** Select [File Name] in the  1 menu, and press .

The [File Name] screen appears.

**2** Use   to select  or , and use   to select a character to enter.

Uppercase alphanumeric characters and "\_" can be entered.

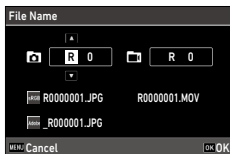

**3** Press .



**Memo** -----

- When [Color Space] is set to [AdobeRGB], the file name prefix is "\_" and first character of the entered character string is used as the file name.

## Sequential Numbering

In [Sequential Numbering] of the  1 menu, you can set whether to continue the sequential numbering for folder and file names even when a new folder is created or memory cards are replaced.

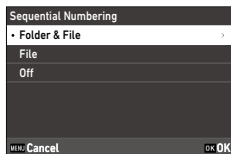

Sequential Numbering	When a New Folder Is Created	When Memory Cards Are Replaced	
	File No.	Folder No.	File No.
Folder & File	Continues	Continues	Continues
File	Continues	Resets	Continues
Off	Resets	Resets	Resets

## Reset Numbering

If [Reset Numbering] of the  1 menu is performed, a folder with a new number is created and file number starts from 0001 when shooting is performed next time.





### Memo

- When the file number reaches 9999, a new folder is created and the file number is reset.
- When a memory card is not inserted, the file number in the internal memory is reset.

## Setting the Copyright Information

You can set the copyright information embedded in the Exif data.

- 1 Select [Copyright Information] in the  1 menu, and press .  
The [Copyright Information] screen appears.
- 2 Select [On] or [Off] in [Embed Copyright Data], and press **OK**.





- 3 Press  in [Copyright Holder].  
The text-entry screen appears.

- 4 Enter the copyright holder.  
Up to 32 single-byte alphanumeric characters and symbols can be entered.



The following operations are available.

	Moves the text selection cursor.
	Moves the text selection cursor up and down.
<b>ADJ</b>	Moves the text selection cursor to the right and left.
<b>OK</b>	Enters a character selected with the text selection cursor.

You can use the touch panel for the operations.

- 5 After entering the text, move the text selection cursor to , and press **OK**.  
The confirmation screen appears.

- 6 After checking the setting, press **OK**.  
The [Copyright Information] screen reappears.



**Memo** -----

- You can check the Exif information in [Detailed Info. Display] (p.21) in the playback mode.

## Attaching Optional Accessories

### Conversion Lens/Lens Adapter

Remove the ring cap before using the teleconversion lens (GT-2) and lens adapter (GA-2).

For details on handling optional accessories, refer to the User's Manual provided with the products.

#### Removing the Ring Cap

Turn the camera off and rotate the ring cap (GN-2) counterclockwise until it can be removed. Do not touch the converter pins (①).

For removing the lens adapter, turn it counterclockwise.

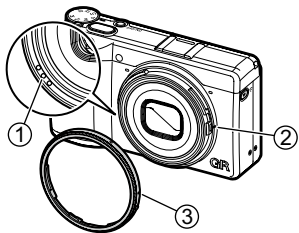

#### Attaching the Ring Cap

With the camera turned off, align the marking on the ring cap (GN-2) (③) with the marking on the camera body (②), and turn the ring cap clockwise until it clicks.

## AC Adapter

If you intend to use the camera continuously for a long period, the use of the AC adapter (D-AC166) is recommended.

**1** Make sure that the camera is turned off, and open the terminal cover.

**2** Connect the USB cable (Type-C) of the AC adapter to the USB terminal of the camera.

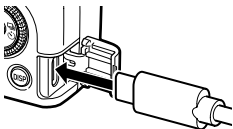

**3** Connect the AC plug cord to the AC adapter, and plug the cord into the power outlet.

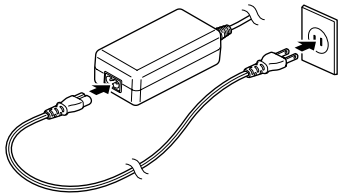

**4** Turn the camera on.



### Caution



- Securely connect the power plug and AC plug cord.
- When the camera is not used, unplug the AC adapter from the power outlet and disconnect it from the camera.
- If the AC adapter is disconnected from the camera or the power plug is unplugged from the power outlet during use of the camera, the data may be lost.
- Do not move the camera by holding the AC adapter cable while the AC adapter is used.
- The AC adapter may not be usable depending on the country and region.

# Troubleshooting



## Power Supply

Problem	Cause	Solution	Page
The camera does not turn on.	The battery is not inserted.	Charge the battery and correctly insert it into the camera.	p.38
	The battery is exhausted.		
	The battery is not inserted in the correct orientation.		
	The battery is incompatible.	Use the battery DB-110 exclusively developed for this camera.	—
	The AC adapter is not correctly connected.	Connect the AC adapter correctly.	—
The camera turns off during use.	The [Auto Power Off] function has been activated because the camera was not operated for a certain period of time.	Turn the camera back on.	p.40
	The battery is exhausted.	Charge the battery.	p.38
The camera does not turn off.	The camera is malfunctioning.	Take the battery out and insert it again.	p.37
The low battery indicator is displayed or the camera turns off even when a fully charged battery is installed.	The battery is incompatible.	Use the battery DB-110 exclusively developed for this camera.	—
The battery cannot be charged.	The battery has failed.	Replace the battery with a new one.	—
	The battery is hot.	Let the battery cool down to room temperature.	—
The battery is quickly exhausted.	Ambient temperature is very high or very low.	—	—





## Shooting

Problem	Cause	Solution	Page
Shooting cannot be performed by pressing <b>SHUTTER</b> .	The battery is exhausted.	Charge the battery.	p.38
	The camera is turned off or not in the shooting mode.	Turn the camera on or press <b>SHUTTER</b> to switch the camera to the shooting mode.	p.40
	The memory card is not formatted.	Perform [Format] in the  1 menu.	p.42
	The memory card is full.	Insert a new card, or delete unwanted files.	p.96
	The memory card has reached end of its service life.	Insert a new memory card.	—
	The memory card is locked.	Unlock the card.	—
The memory card contacts are dirty.	Clean with soft, dry cloth.	—	
Images cannot be checked after shooting.	Confirmation time is too short.	Change the [Display Time] setting of [Instant Review] in the  3 menu.	p.127
The monitor is blank.	The monitor brightness is dark.	Adjust the brightness of the monitor in the  3 menu.	p.128
	The monitor is off.	Press <b>DISP</b> to turn the monitor on.	p.20
	An AV device is connected to the camera.	Remove the cable from the camera.	p.95
The camera is unable to focus in autofocus mode.	The lens is dirty.	Clean with soft, dry cloth.	—
	The subject is not at center of frame.	Lock the focus for shooting.	—
	The subject is not suitable for autofocus.	Lock the focus or set the focus mode to [MF] for shooting.	p.60
	The subject is too close.	Use the macro mode or move away from the subject.	p.61
Images are blurred.	The camera was moved when <b>SHUTTER</b> is pressed.	Hold the camera with your elbows pressed against your body, or use a tripod.	—
	When shooting in a dark place, the shutter speed slows down and pictures become easily blurred.	Use a flash, or set [ISO Setting] to a high ISO sensitivity.	p.65 p.63
The flash does not discharge.	A function preventing flash operation is selected.	Check the settings and mode.	—





Problem	Cause	Solution	Page
The flash does not illuminate the subject.	The subject is dark.	Adjust the flash output.	p.66
	Flash output is not appropriate.		
Images are too bright.	Flash output is not appropriate.	Adjust the flash output, move away from the subject, or use a different light source.	p.66
	The monitor brightness is not appropriate.	Adjust the brightness of the monitor in the  3 menu.	p.128
Images are too dark.	The monitor brightness is not appropriate.	Adjust the brightness of the monitor in the  3 menu.	p.128
	The exposure compensation is set to a negative value.	Change the exposure compensation value.	p.53
The colors of images are unnatural.	The camera is unable to adjust white balance for shooting conditions using auto white balance.	Include a white object with the subject or select the settings other than [Auto White Balance] for [White Balance].	p.69
The monitor brightness changes during autofocus.	Ambient lighting is poor or differs from that used for autofocus.	This is normal and does not indicate a malfunction.	—
Electronic level indicators are not displayed.	Electronic level indicators are hidden.	Check the [Shooting Info. Display] setting in the  3 menu.	p.126
The image is not level although level indicator showed that the camera was level.	The camera was moving during shooting because you were on a moving object or due to other causes.	Do not move the camera during shooting.	—
	The subject is not level.	Check the subject.	—

## Playback/Deletion

Problem	Cause	Solution	Page
Shooting information is not displayed.	Information display is set to [No Information Display].	Press <b>DISP</b> to switch the information displayed on the screen.	p.20
Dust or dirt particles appear in images.	The sensor is dirty or dusty.	Perform [Dust Removal] in the  9 menu. The Dust Removal function can be activated every time the camera is turned on and off.	—
Pixel defects such as bright spots and dark spots appear in the image.	There are defective pixels in the sensor.	Perform [Pixel Mapping] in the  9 menu. It takes about 30 seconds to correct the defective pixels, so be sure to install a fully charged battery.	—
Images are not displayed on an AV device.	The cable is not correctly connected.	Connect the cable correctly.	p.95
	The input setting of the AV device is incorrect.	Check the AV device settings.	—
The images on the memory card cannot be played back. The images are not displayed on the monitor.	The inserted memory card is not formatted with this camera.	Insert a memory card formatted using [Format] of the  1 menu in this camera.	p.42
	The memory card contacts are dirty.	Clean with soft, dry cloth.	—
	The card is malfunctioning.	There is no problem with the camera if images in another memory card can be played back with this camera. Do not use a memory card that has a problem.	—
The monitor turned off.	The battery is exhausted.	Charge the battery.	p.38
	The [Auto Power Off] function has been activated because the camera was not operated for a certain period of time.	Turn the camera back on.	p.40
File(s) cannot be deleted.	[Protect] is set for the image(s).	Cancel the protection in [Protect] of the  1 menu.	p.97
	The memory card is locked.	Unlock the card.	—
The memory card cannot be formatted.	The memory card is locked.	Unlock the card.	—

## Others

Problem	Cause	Solution	Page
The memory card cannot be inserted.	The card is not in the correct orientation.	Insert the memory card in the correct orientation.	p.37
Camera controls have no effect.	The battery is exhausted.	Charge the battery.	p.38
	The camera is malfunctioning.	Turn the camera back on.	p.40
		Take the battery out and insert it again. When the AC adapter is used, reconnect it.	p.37
Date is not set correctly.	Date and time are not set correctly.	Set date and time correctly in the  10 menu.	p.41
The date setting has been reset.	The battery was removed.	If the battery is removed for more than about five days, the date setting will be lost. Set date and time in the  10 menu.	p.41

## Error Messages

Error Message	Description
Memory card full.	The memory card is full and no more images can be saved. Insert a new memory card or delete unwanted files. (p.96)
Internal memory full.	The internal memory is full and no more images can be saved. Insert a memory card or delete unwanted files. (p.96)
No image.	There are no images that can be played back on the memory card and internal memory.
This image cannot be displayed.	You are trying to play back an image in a format not supported by this camera. You may be able to play it back on a computer.
No card in the camera.	There is no memory card inserted in the camera.
Memory card error.	The memory card has a problem, and shooting and playback are impossible. You may be able to play it back on a computer.
Internal Memory Error.	There is a problem with the internal memory. Format the internal memory. (p.42)
Card is not formatted.	The memory card you have inserted is unformatted or has been previously used on another device. Use the card after formatting it with this camera. (p.42)
Card is locked.	The write-protect switch on the memory card inserted is locked.

Error Message	Description
Cannot use this card.	A memory card not compatible with this camera is inserted.
This image cannot be magnified.	You are trying to magnify an image that cannot be magnified.
Not enough battery power remaining to activate Pixel Mapping.	These messages appear if you try to perform the pixel mapping or firmware update when the battery level is insufficient. Install a fully charged battery.
Not enough battery power remaining to update the firmware.	
Image folder cannot be created.	The maximum folder number (999) has been reached, and no more images can be saved. Insert a new memory card or format the card or internal memory. (p.42)
Unable to store image.	The image could not be saved because of a memory card error.
This image cannot be processed.	This message appears when you try to perform the functions in the  2 menu for the images captured using other cameras, or [Resize] or [Cropping] for the minimum-sized images.
The camera will turn off to prevent damage from overheating.	The camera will turn off because its internal temperature is too high. Leave the camera turned off until it has had time to cool down before turning on the camera again.
Update failed.	The update could not be performed correctly. Turn the camera off and on, and then perform the update again.
Unable to update firmware. There is a problem with the firmware update file.	There is a problem with the firmware update file. Download the update file again, and then perform the update.
Pairing failed. Check Action Mode.	Bluetooth® pairing could not be established. Check the settings. (p.112)

# Main Specifications

## Camera

<b>Lens</b>	Lens Construction	7 elements in 5 groups (2 aspherical lens elements)
	Focal Length / Aperture	26.1 mm (approx. 40 mm in 35 mm equivalent focal length) / F2.8 to F16
<b>Image Capture Unit</b>	Image Sensor	Type: Primary color filter CMOS Size: 23.5 mm × 15.6 mm
	Effective Pixels	Approx. 24.24 megapixels
	Sensitivity (standard output)	ISO 100 to ISO 102400: Auto (ISO Auto Lower/Upper Limit and Minimum Shutter Speed can be set), Manual
	Image Stabilization	3-axis sensor-shift shake reduction (SR)
	Anti-Aliasing Filter Simulator	Moiré reduction using SR unit (Off, Low, High)
	Dust Removal	Image sensor cleaning using ultrasonic vibrations "DR II"
<b>File Format</b>	Still Image	File format: RAW (DNG) 14-bit, JPEG (Exif 2.3), DCF 2.0 compliant Color space: sRGB, AdobeRGB Recorded pixels: [3:2] L (24M: 6000×4000) M (15M: 4800×3200) S (7M: 3360×2240) XS (2M: 1920×1280) [1:1] L (16M: 4000×4000) M (10M: 3200×3200) S (5M: 2240×2240) XS (1.6M: 1280×1280)
	Movie	File format: MPEG4 AVC/H.264 (MOV) Recorded pixels: Full HD (1920×1080, 60p/30p/24p) Sound recording: Built-in stereo microphone Recording time: Up to 25 minutes or 4 GB; automatically stops recording if the internal temperature of the camera becomes high.
	Storage Medium	Internal memory (approx. 2 GB), SD/SDHC*/SDXC* memory card * UHS-I compatible

<b>Focus</b>	Type	Hybrid AF (image plane phase-matching and contrast detection)
	Focus Mode	Auto-area AF, Select AF, Pinpoint AF, Tracking AF, Continuous AF, MF, Snap (1 m, 1.5 m, 2 m, 2.5 m, 5 m, $\infty$ ), $\infty$
	Full Press Snap	Shooting by focusing at a fixed distance with a single press of the shutter release button or a touch to the monitor
	Face/Eye Detection	On, Use only in Auto-area AF, Off
	Focus Range (from lens face)	Normal: Approx. 0.2 m to $\infty$ , Macro mode: Approx. 0.12 to 0.24 m
<b>Exposure Control</b>	Exposure Mode	Program AE, Aperture Priority AE, Shutter Priority AE, Manual Exposure
	Metering Mode	Multi-segment, Center-weighted, Spot, Highlight-weighted
	Shutter Speed	1/4000 to 30 seconds (limitation by the aperture: 1/2500 seconds at F2.8; 1/4000 seconds at F5.6 or greater) Bulb timer (10 seconds to 20 minutes), Bulb, Time
	EV Compensation	Still image: $\pm 5$ EV (1/3 EV steps), Movie: $\pm 2$ EV (1/3 EV steps)
	ND Filter (2 EV)	Auto, On, Off
<b>White Balance</b>		Auto White Balance, Multi Auto White Balance, Daylight, Shade, Cloudy, Fl. - Daylight Color, Fl. - Daylight White, Fl. - Cool White, Fl. - Warm White, Tungsten, CTE, Manual White Balance, Color Temperature
	Fine Adjustment	Adjustable $\pm 14$ steps on A-B axis and G-M axis
<b>Drive Mode</b>	Drive	Single Frame Shooting, Continuous Shooting, Bracketing, Multi-exposure, Interval Shooting, Interval Composite
	Self-timer	10 seconds, 2 seconds, Off
<b>Shooting Functions</b>	Crop	50 mm, 71 mm, Off
	Image Control	Standard, Vivid, Monotone, Soft Monotone, Hard Monotone, Hi-Contrast B&W, Positive Film, Bleach Bypass, Retro, HDR Tone, Cross Processing, Custom 1, Custom 2 Adjustment parameter: Saturation, Hue, High/Low Key Adjustment, Contrast, Contrast (Highlight), Contrast (Shadow), Sharpness, Shading, Clarity, Toning, Filter Effect, Grain Effect, HDR Tone Level, Color Tone (available parameters vary depending on the selected image)
	Dynamic Range Correction	Highlight Correction, Shadow Correction
	Noise Reduction	Slow Shutter Speed Noise Reduction, High-ISO Noise Reduction
	Horizon Correction	SR On: Correction of up to 1.0°, SR Off: Correction of up to 1.5°
	Display	Display magnification (4 $\times$ , 16 $\times$ ), Grid display (3 $\times$ 3 Grid, 4 $\times$ 4 Grid), Histogram, Highlight Alert, Electronic Level Display

<b>Playback Functions</b>	Playback View	Single image display, Multiple image display (20 thumbnails, 48 thumbnails), Display magnification (up to 16×, 100% view and Quick Zoom view available), Histogram (Y histogram, RGB histogram), Grid display (3×3 Grid, 4×4 Grid), Highlight Alert, Auto Image Rotation
	Base Parameter Adjustment	Normal editing, Monotone editing Adjustment parameter: Brightness, Saturation, Filter Effect, Hue, Toning, Contrast, Sharpness (available parameters vary depending on the editing method selected)
	RAW Development	JPEG Recorded Pixels, Aspect Ratio, Color Space, White Balance, Image Control, Peripheral Illumination Correction, Sensitivity, High-ISO Noise Reduction, Shadow Correction
	Edit	Delete, Protect, Image Rotation, Image Copy, File Transfer, Resize, Cropping (aspect ratio change and slant adjustment available), Levels Adjustment, White Balance Adjustment, Color Moiré Correction, Movie Edit (Cut, Divide)
<b>LCD Monitor</b>	Type	3.0 inch TFT color LCD (aspect ratio 3:2), Approx. 1037K dots, Wide viewing angle, Air-gapless tempered glass
	Touch Panel	Capacitive sensing method
	Adjustment	Brightness, Saturation, Blue/Amber, Green/Magenta, Outdoor View Setting: ±2 steps
<b>Wireless LAN</b>	Standards	IEEE 802.11b/g/n (HT20) (standard wireless LAN protocol)
	Frequency (center frequency)	2412 to 2462 MHz (Ch 1 to Ch 11)
	Security	Authentication: WPA2, Encryption: AES
<b>Bluetooth®</b>	Standards	Bluetooth® v4.2 (Bluetooth Low Energy)
	Frequency (center frequency)	2402 to 2480 MHz (Ch 0 to Ch 39)
<b>Interfaces</b>	USB Type-C	Battery recharge and camera power supply (optional AC adapter required), Data transfer: MTP, Video output: DisplayPort over USB-C (DisplayPort alternative mode)
	Hot Shoe	Compatible with P-TTL auto flash Flash mode: Flash On, Flash On+Red-eye, Slow-speed Sync, Slow Sync+Red-eye Flash Exposure Compensation: -2.0 to +1.0
	Lens Adapter Pin	Available

<b>Power Supply</b>	Battery Type	Rechargeable battery DB-110
	AC Adapter	AC adapter kit K-AC166 (optional)
	Battery Life	Number of recordable images: Approx. 200 images * Tested in compliance with CIPA standard using a fully charged rechargeable battery at a temperature of 23°C (73°F). Actual results may vary depending on the shooting conditions/circumstances. Playback time: Approx. 180 minutes * According to the result of RICOH in-house testing. Actual performance may vary depending on the shooting conditions/circumstances.
<b>Dimensions and Weight</b>	Dimensions	Approx. 109.4 mm (W) × 61.9 mm (H) × 35.2 mm (D) (4.3 in. (W) × 2.4 in. (H) × 1.4 in. (D)) (excluding operating controls and protrusions)
	Weight	Approx. 262 g (9.2 oz) (including the dedicated battery and an SD memory card) Approx. 232 g (8.2 oz) (body only)
<b>Included Accessories</b>		Rechargeable battery DB-110, USB power adapter, Power plug, USB cable I-USB166, Hand strap
<b>Language</b>		English, French, Germany, Spanish, Portuguese, Italy, Dutch, Danish, Swedish, Finnish, Polish, Czech, Hungarian, Turkey, Greek, Russian, Thai, Korean, Simplified Chinese, Traditional Chinese, Japanese



## USB Power Adapter AC-U1/AC-U2

Power Supply	100 to 240 VAC (50/60 Hz), 0.2 A
Output	5.0 VDC, 1000 mA, 5.0 W
Average Active Efficiency*1	76.8%
No-Load Power Consumption*1	70 mW
Temperature	10 to 40°C (50 to 104°F)
Dimensions	42.5 mm (W) × 22 mm (H) × 66.5 mm (D) (1.7 in. (W) × 0.9 in. (H) × 2.6 in. (D)) (excluding the power plug)
Weight	Approx. 40 g (1.4 oz) (excluding the power plug)

\*1 AC-U2 only

## Rechargeable Battery DB-110

Nominal Voltage	3.6 V
Rated Capacity	1350 mAh, 4.9 Wh
Operating Temperature	0 to 40°C (32 to 104°F)
Storage Temperature	-10 to 45°C (14 to 104°F)
Dimensions	39.8 mm (W) × 34.2 mm (H) × 8.5 mm (D) (1.6 in. (W) × 1.3 in. (H) × 0.3 in. (D))
Weight	Approx. 26 g (0.9 oz)

## Image Storage Capacity

The following table shows the approximate number of images and recording time (in seconds) of movies that can be saved in the internal memory and a memory card in various formats.

### Still image

File Format/JPEG Recorded Pixels	Aspect Ratio	Focal Length* <sup>1</sup>	Number of Recorded Pixels	Internal Memory	Memory Card 8 GB
L	3:2	—	6000×4000	140	527
	1:1	—	4000×4000	209	788
M	3:2	—	4800×3200	218	820
	1:1	—	3200×3200	324	1220
S	3:2	—	3360×2240	437	1646
	1:1	—	2240×2240	645	2428
XS	3:2	—	1920×1280	1253	4717
	1:1	—	1280×1280	1810	6813
RAW	3:2	40 mm	6000×4000	40	150
		50 mm		40	154
		71 mm		41	157
	1:1	40 mm		40	153
		50 mm		41	156
		71 mm		42	158
RAW+	3:2	40 mm	6000×4000	31	117
		50 mm		34	129
		71 mm		38	143
	1:1	40 mm		34	128
		50 mm		36	138
		71 mm		39	148

\*1 35 mm equivalent focal length

### Movie

Resolution	Aspect Ratio	Framerate	Number of Recorded Pixels	Internal Memory	Memory Card 8 GB
Full HD	16:9	60p	1920 × 1080	3:16	12:17
	16:9	30p		6:25	24:09
	16:9	24p		7:57	29:56



## Memo

- The figures for movies are the total time length that can be recorded. The maximum recording time per shooting is 25 minutes or the equivalent of 4 GB.
- The number of images that can be taken may differ from the number of storable images displayed on the monitor.
- The storage capacity varies depending on the shooting conditions and the capacity of the memory.

## Operating Environment

It is confirmed that a USB connection can be established between the camera and the following OSs.

Windows®	Windows® 10 (FCU, CU) (32-bit, 64-bit), Windows® 8.1 (32-bit, 64-bit)
Mac	macOS 11 Big Sur, macOS 10.15 Catalina

## Using the Camera Abroad

### **USB Power Adapter (AC-U1/AC-U2), AC Adapter (D-AC166), and Battery Charger (BJ-11)**

These products are for use with currents of 100 to 240 V and 50 or 60 Hz. Before traveling, purchase a travel adapter for connection to the type of outlets used at your destination. Do not use these products with electrical transformers, as this could damage the camera.

# Precautions for Use

## Camera

- Do not drop the camera or subject it to physical shocks.
- When carrying the camera, be careful that it does not strike other objects. Particular care is required to protect the lens and monitor.
- Battery may become hot with extended use. Wait for the battery to cool before removing it from the camera.
- The monitor may be difficult to read in direct sunlight.
- You may notice that monitor varies in brightness or contains pixels that do not light or that are always lit. This is common to all LCD monitors and does not indicate a malfunction.
- Do not apply force to the monitor.
- Abrupt changes in temperature may cause condensation, resulting in visible condensation inside the lens or camera malfunction. This can be avoided by placing the camera in a plastic bag to slow the temperature change, and removing it only after the air in the bag has reached the same temperature of its surroundings.
- To prevent damage to the product, do not insert objects into the holes in the microphone and speaker coverings.
- Do not allow the camera to get wet. In addition, do not operate it with wet hands. Failure to observe this precaution could result in product malfunction or electric shock.
- Take a test shot to ensure that the camera is functioning properly before using it on important occasions such as travel or weddings. We recommend that you keep this manual and spare batteries at hand.



### **Conditions that May Cause Condensation**-----

- If you move to an area with a sharply different temperature
- If humidity is high
- In a cold room after the heater has come on, or where the camera is exposed to cold air from an air conditioner or other device

## USB Power Adapter AC-U1/AC-U2

- Use the USB cable contained in the package.
- Do not subject the power adapter to severe impact or force.
- Do not use in extreme high or low temperatures or areas subject to vibration.
- Do not use in an area subject to direct sunlight or high temperature.
- Unplug the power plug from the power outlet after charging. Failure to observe this precaution could result in fire.
- Do not allow other metallic objects to come in contact with the connectors, or contacts of the rechargeable battery as this can result in a short circuit.
- The operating temperature range is 10 to 40°C (50 to 104°F). Charging takes longer at temperatures below 10°C (50°F).

## Rechargeable Battery DB-110

- This is a lithium-ion battery.
- The battery is not fully charged at the time of purchase, so be sure to charge the battery before use.
- Do not open or damage the battery as this can result in fire or injury. In addition, do not heat the battery above 60°C (140°F) or expose the battery to fire.
- Due to the battery characteristics, the battery usage time may be shortened when used in a cold environment, even if the battery is fully charged. Keep the battery warm by placing it in a pocket or have a backup battery ready.
- When not in use, be sure to remove the battery from the camera or the battery charger. A small amount of current can leak from the battery even when the power is off, creating excessive discharge and making the battery unusable. If the battery is removed for more than five days, the date and time settings will be lost. In this case, reset the date and time.
- If the battery is not used for a long time, charge the battery for 15 minutes once a year before storing.
- Store in a dry, cool place with an ambient temperature between 15°C and 25°C (59°F and 77°F). Avoid storing in extreme high or low temperatures.
- After charging the battery, do not immediately charge it again.
- Charge the battery at an ambient temperature between 10°C and 40°C (50°F and 104°F). Charging the battery at a high temperature can deteriorate the battery. Charging at a low temperature may prevent full charging.
- If the battery usage time becomes very short even when fully charged, the battery has reached the end of its service life. Replace with a new battery. Be sure to use a replacement battery recommended by RICOH IMAGING.
- The charging time with the camera using the AC-U1/AC-U2 is approximately 2.5 hours (at 25°C (77°F)).



### Caution

- Use of other batteries can cause explosion.

# Camera Care and Storage

## Caring for the Camera

- Image quality can be affected by fingerprints and other foreign matter on the lens. Avoid touching the lens with your fingers.
- Remove dust or lint on the lens with a commercially available blower, or gently clean the lens with a soft, dry cloth.
- Clean the camera thoroughly after using it at the beach in a place where chemicals are handled.
- In the unlikely event of malfunction, consult your nearest repair center.
- The camera contains high-voltage circuits. Do not disassemble it.
- Do not expose the camera to volatile substances such as thinner, benzene, or pesticides. Failure to observe this precaution could result in damage to the camera or its coatings.
- The monitor is easily scratched. Avoid touching it with hard objects.
- Clean the monitor by wiping it with a soft cloth dampened with a small amount of any monitor cleaner that does not contain organic solvents.

## Storage

- Do not store the camera where it will be exposed to:
  - Extreme heat or humidity, large changes in temperature or humidity
  - Dust, dirt, sand
  - Severe vibration
  - Prolonged contact with chemicals including pesticides, or with vinyl or rubber products
  - Strong magnetic fields (for example, in the vicinity of a monitor, transformer, or magnet)
- Remove the battery if the product is left unused for a long period of time.

## Before Cleaning

- Be sure to turn the camera off.
- Remove the battery and AC adapter from the camera.

## Warranty Policy

All our cameras purchased through authorized bona fide photographic distribution channels are guaranteed against defects of material or workmanship for a period of twelve months from the date of your purchase. Service will be rendered, and defective parts will be replaced without cost to you within that period, provided the camera does not show evidence of impact, sand or liquid damage, mishandling, tampering, battery or chemical corrosion, operation contrary to operating instructions, or modification by an unauthorized repair shop. The manufacturer or its authorized representatives shall not be liable for any repair or alterations except those made with its written consent and shall not be liable for damages from delay or loss of use or from other indirect or consequential damages of any kind, whether caused by defective material or workmanship or otherwise; and it is expressly agreed that the liability of the manufacturer or its representatives under all guarantees or warranties, whether expressed or implied, is strictly limited to the replacement of parts as hereinbefore provided. No refunds will be made on repairs by non-authorized service facilities.

### Procedure During 12-month Warranty Period

Any camera which proves defective during the 12-month warranty period should be returned to the dealer from whom you purchased the camera or to the manufacturer. If there are no representatives of the manufacturer in your country, send the camera to the manufacturer, with postage prepaid. In this case, it will take a considerable length of time before the camera can be returned to you owing to the complicated customs procedures required. If the camera is covered by warranty, repairs will be made and parts replaced free of charge, and the camera will be returned to you upon completion of servicing. If the camera is not covered by warranty, regular charges of the manufacturer or of its representatives will apply. Shipping charges are to be borne by the owner. If your camera was purchased outside of the country where you wish to have it serviced during the warranty period, regular handling and servicing fees may be charged by the manufacturer's representatives in that country. Notwithstanding this, your camera returned to the manufacturer will be serviced free of charge according to this procedure and warranty policy. In any case, however, shipping charges and customs clearance fees to be borne by the sender. To prove the date of your purchase when required, please keep the receipt or bills covering the purchase of your camera for at least a year. Before sending your camera for servicing, please make sure that you are sending it to the manufacturer's authorized representatives or their approved repair shops, unless you are sending it directly to the manufacturer. Always obtain a quotation for the service charge, and only after you accept the quoted service charge, instruct the service station to proceed with the servicing.

- **This warranty policy does not affect the customer's statutory rights.**
- **The local warranty policies available from our distributors in some countries can supersede this warranty policy. Therefore, we recommend that you review the warranty card supplied with your product at the time of purchase, or contact our distributor in your country for more information and to receive a copy of the warranty policy.**



## For Customers in USA

### STATEMENT OF FCC COMPLIANCE

This device complies with Part 15 of the FCC Rules. Operation is subject to the following two conditions: (1) This device may not cause harmful interference, and (2) this device must accept any interference received, including interference that may cause undesired operation.

Changes or modifications not expressly approved by the party responsible for compliance could void the user's authority to operate the equipment.

This equipment has been tested and found to comply with the limits for a Class B digital device, pursuant to part 15 of the FCC Rules. These limits are designed to provide reasonable protection against harmful interference in a residential installation. This equipment generates, uses and can radiate radio frequency energy and, if not installed and used in accordance with the instructions, may cause harmful interference to radio communications. However, there is no guarantee that interference will not occur in a particular installation. If this equipment does cause harmful interference to radio or television reception, which can be determined by turning the equipment off and on, the user is encouraged to try to correct the interference by one or more of the following measures:

- Reorient or relocate the receiving antenna.
  - Increase the separation between the equipment and receiver.
  - Connect the equipment into an outlet on a circuit different from that to which the receiver is connected.
- \* Consult the dealer or an experienced radio/TV technician for help.

This transmitter must not be co-located or operated in conjunction with any other antenna or transmitter.

The available scientific evidence does not show that any health problems are associated with using low power wireless devices. There is no proof, however, that these low power wireless devices are absolutely safe. Low power Wireless devices emit low levels of radio frequency energy (RF) in the microwave range while being used. Whereas high levels of RF can produce health effects (by heating tissue), exposure of low-level RF that does not produce heating effects causes no known adverse health effects. Many studies of low-level RF exposures have not found any biological effects. Some studies have suggested that some biological effects might occur, but such findings have not been confirmed by additional research. R05010 has been tested and found to comply with FCC radiation exposure limits set forth for an uncontrolled environment and meets the FCC radio frequency (RF) Exposure Guidelines.

## Declaration of Conformity According to 47CFR, Parts 2 and 15 for Class B Personal Computers and Peripherals

We: RICOH IMAGING AMERICAS CORPORATION  
Located at: 2 Gatehall Drive Suite 204, Parsippany,  
New Jersey 07054, U.S.A.  
Phone: 800-877-0155

Declare under sole responsibility that the product identified herein complies with 47CFR Parts 2 and 15 of the FCC rules as a Class B digital device. Each product marketed is identical to the representative unit tested and found to be compliant with the standards. Records maintained continue to reflect the equipment being produced can be expected to be within the variation accepted, due to quantity production and testing on the statistical basis as required by 47CFR §2.909. Operation is subject to the following two conditions: (1) This device may not cause harmful interference, and (2) This device must accept any interference received, including interference that may cause undesired operation. The above named party is responsible for ensuring that the equipment complies with the standards of 47CFR §15.101 to §15.109.

7

Appendix

Product Name: Digital Camera  
Model Number: R05010  
Contact Person: Customer Service Manager  
Date and Place: May, 2021 Parsippany

## **For Customers in USA and Canada**

Lithium-ion batteries are recyclable.

You can help preserve our environment by returning your used rechargeable batteries to the collection and recycling location nearest you.

For more information regarding recycling of rechargeable batteries, call toll free 1-800-822-8837, or visit <https://www.call2recycle.org/>.

## **For Customers in Canada Innovation, Science and Economic Development Canada (ISED) Regulatory Compliance Notice**

This Class B digital apparatus complies with Canadian ICES-003 (B).

This device contains licence-exempt transmitter(s)/receiver(s) that comply with Innovation, Science and Economic Development Canada's licence-exempt RSS(s). Operation is subject to the following two conditions:

1. This device may not cause interference.
2. This device must accept any interference, including interference that may cause undesired operation of the device.

The available scientific evidence does not show that any health problems are associated with using low power wireless devices. There is no proof, however, that these low power wireless devices are absolutely safe. Low power wireless devices emit low levels of radio frequency energy (RF) in the microwave range while being used. Whereas high levels of RF can produce health effects (by heating tissue), exposure of low-level RF that does not produce heating effects causes no known adverse health effects. Many studies of low-level RF exposures have not found any biological effects. Some studies have suggested that some biological effects might occur, but such findings have not been confirmed by additional research. The R05010 has been tested and found to comply with ISED radiation exposure limits set forth for an uncontrolled environment and meets RSS-102 of the ISED radio frequency (RF) Exposure rules.

## **Pour les utilisateurs au Canada**

### **Avis de conformité à la réglementation d'Innovation, Sciences et Développement économique Canada (ISDE)**

Cet appareil numérique de la classe B est conforme à la norme NMB-003 (B) du Canada.

L'émetteur/récepteur exempt de licence contenu dans le présent appareil est conforme aux CNR d'Innovation, Sciences et Développement économique Canada applicables aux appareils radio exempts de licence. L'exploitation est autorisée aux deux conditions suivantes :

1. L'appareil ne doit pas produire de brouillage ;
2. L'appareil doit accepter tout brouillage radioélectrique subi, même si le brouillage est susceptible d'en compromettre le fonctionnement.

Les connaissances scientifiques dont nous disposons n'ont mis en évidence aucun problème de santé associé à l'usage des appareils sans fil à faible puissance. Nous ne sommes cependant pas en mesure de prouver que ces appareils sans fil à faible puissance sont entièrement sans danger. Les appareils sans fil à faible puissance émettent une énergie fréquence radioélectrique (RF) très faible dans le spectre des micro-ondes lorsqu'ils sont utilisés. Alors qu'une dose élevée de RF peut avoir des effets sur la santé (en chauffant les tissus), l'exposition à de faibles RF qui ne produisent pas de chaleur n'a pas de mauvais effets connus sur la santé. De nombreuses études ont été menées sur les expositions aux RF faibles et n'ont découvert aucun effet biologique. Certaines études ont suggéré qu'il pouvait y avoir certains effets biologiques, mais ces résultats n'ont pas été confirmés par des recherches supplémentaires. Le R05010 a été testé et jugé conforme aux limites d'exposition aux rayonnements ISDE énoncées pour un environnement non contrôlé et respecte les règles d'exposition aux fréquences radioélectriques (RF) CNR-102 de l'ISDE.

## For Customers in Europe

### Information for Users on Collection and Disposal of Old Equipment and Used Batteries



#### 1. In the European Union

These symbols on the products, packaging and/or accompanying documents mean that used electrical and electronic equipment and batteries should not be mixed with general household waste.

Used electrical/electronic equipment and batteries must be treated separately and in accordance with legislation that requires proper treatment, recovery and recycling of these products.



By disposing of these products correctly you will help ensure that the waste undergoes the necessary treatment, recovery and recycling and thus prevent potential negative effects on the environment and human health which could otherwise arise due to inappropriate waste handling.

If a chemical symbol is added beneath the symbol shown above, in accordance with the Battery Directive, this indicates that a heavy metal (Hg = Mercury, Cd = Cadmium, Pb = Lead) is present in the battery at a concentration above an applicable threshold specified in the Battery Directive.

For more information about collection and recycling of used products, please contact your local authorities, your waste disposal service or the point of sale where you purchased the products.

#### 2. In other countries outside the EU

These symbols are only valid in the European Union. If you wish to discard used products, please contact your local authorities or dealer and ask for the correct method of disposal.

For Switzerland: Used electrical/electronic equipment can be returned free of charge to the dealer, even when you don't purchase a new product. Further collection facilities are listed on the home page of [www.swico.ch](http://www.swico.ch) or [www.sens.ch](http://www.sens.ch).

## Notice to Users in Countries that Require the CE Marking

This product complies with the essential requirements and provisions of RE Directive 2014/53/EU.

The EU Declaration of Conformity is available by accessing the URL:

[https://www.ricoh-imaging.co.jp/english/support/declaration\\_of\\_conformity.html](https://www.ricoh-imaging.co.jp/english/support/declaration_of_conformity.html)  
and selecting the product applicable.

Operating frequency band: 2400 MHz - 2483.5 MHz

Maximum radio-frequency power: 9.15 dBm EIRP

Importer (CE Marking): RICOH IMAGING EUROPE S.A.S.

Parc Tertiaire SILIC 7-9, avenue Robert Schuman - B.P. 70102, 94513 Rungis Cedex,  
FRANCE

Manufacturer: RICOH IMAGING COMPANY, LTD.

1-3-6, Nakamagome, Ohta-ku, Tokyo 143-8555, JAPAN



The CE Mark is a Directive conformity mark of the European Union.

## Notice to Users in Countries that Require the UKCA Marking

This product complies with the essential requirements and provisions of Radio Equipment Regulations 2017.

The UK Declaration of Conformity is available by accessing the URL:

[https://www.ricoh-imaging.co.jp/english/support/declaration\\_of\\_conformity.html](https://www.ricoh-imaging.co.jp/english/support/declaration_of_conformity.html)  
and selecting the product applicable.

Operating frequency band: 2400 MHz - 2483.5 MHz

Maximum radio-frequency power: 9.15 dBm EIRP

Manufacturer : RICOH IMAGING COMPANY, LTD.

1-3-6, Nakamagome, Ohta-ku, Tokyo 143-8555, JAPAN



The UKCA Mark is a Regulation conformity mark of the United Kingdom.

## For Customers in Thai

This telecommunication equipment conforms to the requirements of the Office of the National Broadcasting and Telecommunications Commission.



เครื่องวิทยุคมนาคมนี้ ได้รับยกเว้น ไม่ต้องได้รับ  
ใบอนุญาตให้มี ใช้ซึ่งเครื่องวิทยุคมนาคม  
หรือตั้งสถานีวิทยุคมนาคมตามประกาศ กสทช.  
เรื่อง เครื่องวิทยุคมนาคม และสถานีวิทยุ  
คมนาคมที่ได้รับยกเว้นไม่ต้องได้รับใบอนุญาต  
วิทยุคมนาคม ตามพระราชบัญญัติวิทยุ  
คมนาคม พ.ศ. 2498



**nanb.** | โทรคมนาคม  
กำกับดูแลเพื่อประชาชน  
Call Center 1200 (Insw5)

7

Appendix



# Index

## Numerics

4-way Controller ..... 59

## A

AC adapter ..... 140  
ADJ. lever ..... 23  
ADJ. mode ..... 121  
AdobeRGB ..... 84  
AE Lock ..... 50  
AE Metering ..... 63  
AF Assist Light ..... 58  
AF point ..... 59  
Animation Setting ..... 47  
Anti-Aliasing Filter Simulator ..... 86  
Aperture Priority AE ..... 48  
Aperture value ..... 48  
Aspect Ratio ..... 84  
Auto-area AF (Focus) ..... 57  
Auto bracketing ..... 76  
Auto EV Compensation ..... 49  
Auto Image Rotation ..... 94  
Auto Image Transfer ..... 116  
Auto Power Off ..... 131  
Auto Resize ..... 116  
Auto SR Off ..... 90  
Auto White Balance (White Balance) ..... 69  
AV device ..... 95  
Av mode ..... 48

## B

Base Parameter Adj ..... 107  
Battery ..... 37, 38  
Battery level ..... 19  
Bleach Bypass (Image Control) ..... 87  
Bluetooth® ..... 112  
Bracketing ..... 76  
Bulb ..... 51  
Bulb timer ..... 51  
Button ..... 16

## C

Card ..... 37  
Care ..... 157  
Center-weighted (AE Metering) ..... 63  
Certification Marks ..... 2  
Changing display ..... 20

Charging the battery ..... 38  
Cloudy (White Balance) ..... 69  
Color Moiré Correction ..... 106  
Color Space ..... 84  
Color Temperature (White Balance) ..... 73  
Communication device ..... 111  
Connection to a computer ..... 110  
Continuous AF (Focus) ..... 57  
Continuous Shooting ..... 75  
Conversion lens ..... 139  
Copyright Information ..... 138  
Correcting a range of tones ..... 89  
Count Down ..... 129  
Create New Folder ..... 133  
Crop ..... 84  
Cropping ..... 102  
Cross Processing (Image Control) ..... 87  
CTE (White Balance) ..... 69  
Customization ..... 121  
Customize Settings menus ..... 33  
Cut (Movie) ..... 108

## D

Date Adjustment ..... 41  
Daylight (White Balance) ..... 69  
Delete ..... 96  
Dial ..... 16  
Direct keys ..... 22  
DisplayPort ..... 95  
Divide (Movie) ..... 108  
DNG ..... 84  
Drive Mode ..... 74  
Dust Removal ..... 144  
Dynamic Range Compensation ..... 89

## E

Editing images ..... 100  
Electronic Level ..... 126  
Electronic Level Type ..... 128  
EV compensation ..... 53  
Exif ..... 138  
Exposure Mode ..... 48, 120

## F

Face/Eye Detection ..... 58  
File Format ..... 84  
File Name ..... 136  
File Transfer ..... 99  
Flash ..... 65

Flash Exposure Compensation .....	66	ISO Setting .....	64
Flash Mode .....	66	<b>J</b>	
Flash On (Flash) .....	66	JPEG Recorded Pixels .....	84
Flash On+Red-eye (Flash) .....	66	<b>K</b>	
Flicker Reduction .....	128	Keep AE Lock .....	124
Fluorescent (White Balance) .....	69	<b>L</b>	
Fn button .....	24	Language setting .....	41
Fn Button Setting .....	123	LCD Auto Dim .....	132
Focus .....	44, 58	LCD Setting .....	128
Focus bar .....	60	Lens adapter .....	139
Focus frame .....	44	Levels Adjustment .....	103
Focus Magnification .....	47	Lever .....	16
Focus Peaking .....	58	Link AE and AF Point .....	63
Folder Name .....	134	<b>M</b>	
Format .....	42	Macro .....	61
Framerate .....	85	Magnifying captured image .....	46
Full Press Snap .....	62	Magnifying Live View image .....	45
<b>G</b>		Manual Exposure .....	48
Grid Guide .....	126	Manual focus .....	60
Grid Style .....	128	Manual White Balance	
Guide Display .....	24, 124	(White Balance) .....	72
<b>H</b>		Memory card .....	37
Hard Monotone (Image Control) .....	87	Menu .....	25
HDR Tone (Image Control) .....	87	MF .....	60
High Contrast Black & White		MF Auto Magnification .....	60
(Image Control) .....	87	M mode .....	48
High-ISO Noise Reduction .....	67	M Mode Dial Setting .....	52
Highlight Alert .....	126	Monitor .....	18
Highlight Correction .....	89	Monotone (Image Control) .....	87
Highlight-weighted (AE Metering) .....	63	Movie .....	54
Histogram .....	126	Movie Capture Settings .....	85
Horizon Correction .....	90	Movie Edit .....	108
<b>I</b>		Movie Settings menus .....	30
Image Capture Settings .....	84	Movie SR .....	90
Image Control .....	87	Multi Auto White Balance	
Image Copy .....	98	(White Balance) .....	69
Image Rotation .....	94	Multi-exposure .....	77
Image Sync .....	116	Multiple image display .....	92
Image Transfer while Off .....	116	Multiple image selection .....	93
Infinity (Focus) .....	57	Multi-segment (AE Metering) .....	63
Initial settings .....	40	<b>N</b>	
Instant Review .....	44, 127	ND Filter .....	86
Internal memory .....	38, 98	Noise Reduction .....	67
Interval Composite .....	81		
Interval Shooting .....	79		
ISO sensitivity .....	64		

<b>O</b>	
One Push AE in M Mode.....	52, 124
Operating environment.....	153
Outdoor View Setting.....	129
<b>P</b>	
Package contents.....	13
Pairing.....	112
Peripheral Illumination Correction.....	89
Pinpoint AF (Focus).....	57
Pixel Mapping.....	144
Playback.....	46, 91
Playback Information Display.....	126
Playback Order Options.....	92
Playback Settings menus.....	32
P mode.....	48
Positive Film (Image Control).....	87
Power.....	40
Power Button Lamp.....	129
Preview.....	52
Processing images.....	100
Program AE.....	48
Program Line.....	51
Program mode.....	44
Protect.....	97
<b>Q</b>	
Quick Zoom.....	127
<b>R</b>	
RAW.....	84
RAW Development.....	100
Reducing blurring of images.....	90
Remote Capture.....	116
Reset.....	26, 42
Reset Numbering.....	137
Resize.....	102
Retro (Image Control).....	87
Ring cap.....	139
<b>S</b>	
Saving power.....	131
SD memory card.....	37
Select AF (Focus).....	57
Self-timer.....	83
Sensitivity.....	64
Sequential Numbering.....	137
Setup menus.....	35
Shade (White Balance).....	69
Shadow Correction.....	89
Shake Reduction.....	90
Sharing.....	110
Shooting close-ups.....	61
Shooting Information Display.....	126
Shutter Button Confirmation.....	125
Shutter Button Setting.....	125
Shutter Priority AE.....	48
Shutter speed.....	48
Single image display.....	46
Sleep Mode.....	132
Slow Shutter Speed Noise Reduction.....	67
Slow-speed Sync (Flash).....	66
Slow Sync+Red-eye (Flash).....	66
Smartphone.....	111
Smartphone Link.....	116
Snap (Focus).....	57
Snap Focus Distance.....	57
Soft Monotone (Image Control).....	87
Sound Effects.....	130
Sound Recording.....	85
Specifications.....	147
Spot (AE Metering).....	63
sRGB.....	84
Still Image Settings menus.....	27
Storage.....	157
Storage capacity.....	39, 152
Store Cursor Position.....	26
Store Location Information.....	116
<b>T</b>	
Time.....	51
Touch AF.....	50
Touch panel.....	21
Tracking AF (Focus).....	57
Tungsten (White Balance).....	69
TV.....	95
Tv mode.....	48
<b>U</b>	
USB cable.....	110
USB power adapter.....	38
User Mode.....	117
<b>V</b>	
Vivid (Image Control).....	87
Volume.....	130
Volume label.....	43

## **W**

Warranty Policy .....	158
White Balance .....	69
White Balance Adjustment .....	105
Wireless LAN.....	114

**RICOH IMAGING COMPANY, LTD.**

1-3-6, Nakamagome, Ohta-ku, Tokyo 143-8555,  
JAPAN  
(<https://www.ricoh-imaging.co.jp>)

**RICOH IMAGING EUROPE  
S.A.S.**

Parc Tertiaire SILIC 7-9, avenue Robert Schuman -  
B.P. 70102, 94513 Rungis Cedex, FRANCE  
(<https://www.ricoh-imaging.eu>)

**RICOH IMAGING  
AMERICAS CORPORATION**

2 Gatehall Drive Suite 204, Parsippany, New Jersey  
07054, U.S.A.  
(<https://www.us.ricoh-imaging.com>)

**RICOH IMAGING CANADA  
INC.**

5560 Explorer Drive Suite 100, Mississauga, Ontario,  
L4W 5M3, CANADA  
(<https://www.ricoh-imaging.ca>)

**RICOH IMAGING CHINA  
CO., LTD.**

Room A 23F Lansheng Building, 2-8 Huaihaizhong  
Road, Huangpu District, Shanghai, CHINA  
(<http://www.ricoh-imaging.com.cn>)

**<https://www.ricoh-imaging.co.jp/english/>**

This contact information may change without  
notice. Please check the latest information on our  
websites.

RICOH IMAGING COMPANY, LTD.  
December, 2022

**En** EN (USA) GB (GB) AE (AE)  
Printed in Vietnam



\* 4 Q C X Z 0 2 0 A \*